

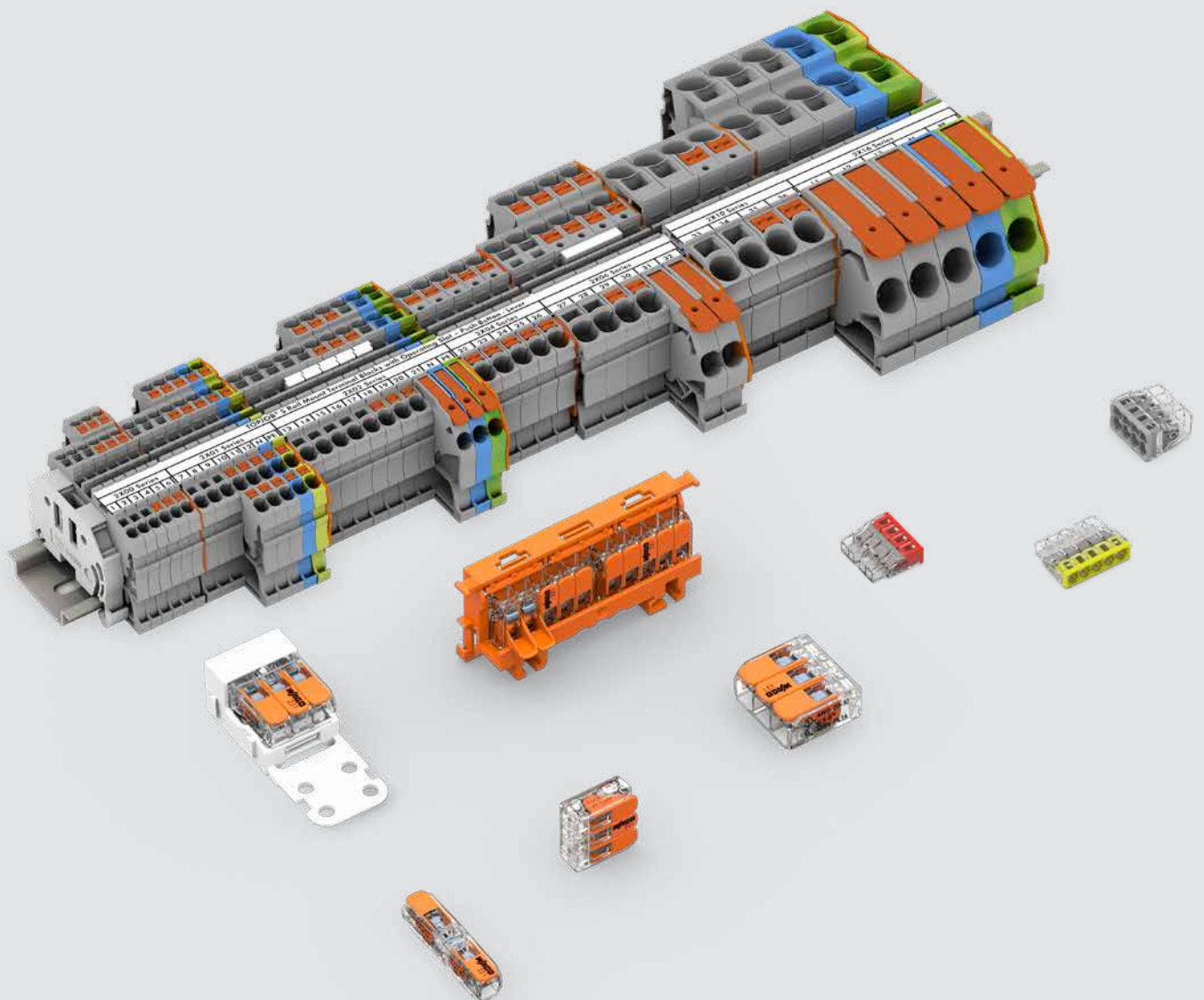

WAGO Rail-Mount Terminal Blocks and Connectors

Full Line Catalog, Volume 1 – Edition 2021/2022

1



WAGO Full Line Catalogs



Volume 1, WAGO Rail-Mount Terminal Blocks and Connectors

- Rail-Mount Terminal Blocks
- Rail-Mount Terminal Blocks with Pluggable Connector (X-COM®-SYSTEM)
- Patchboard Systems
- Terminal Strips
- PUSH WIRE® Connectors for Junction Boxes
- Lighting Connectors
- Shield Connecting System



Volume 2, WAGO PCB Terminal Blocks and Connectors

- PCB Terminal Blocks
- THR/SMD PCB Terminal Blocks
- *MULTI CONNECTION SYSTEM (MCS)*
- Pluggable PCB Terminal Blocks
- Feedthrough Terminal Blocks
- Specialty Connectors
- Empty Housings



Volume 3, Automation Technology

- Solutions & Software
- Operating & Monitoring
- Controllers, Edge Devices
- Modular I/O-SYSTEM IP20, I/O-SYSTEM IP67
- Industrial Switches
- Radio Technology
- IP67 Sensor/Actuator Boxes, IP67 Cables and Connectors

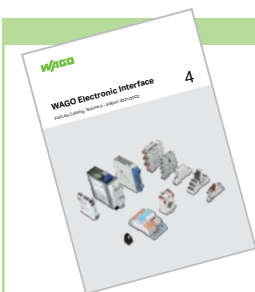

Volume 4, WAGO Interface Electronic

- Relay and Optocoupler Modules
- Signal Conditioners and Isolation Amplifiers
- Current and Energy Measurement Technology
- Power Supplies
- Interface Modules and System Wiring
- Overvoltage Protection
- Empty Housings



Volume 5, WAGO Pluggable Connection System *WINSTA*®

- Pluggable Connectors
- Snap-In Device Connectors
- Pluggable PCB Connectors
- Distribution Connectors
- Cable Assemblies
- Flat Cable Systems
- Distribution Boxes



Volume 6, WAGO Marking

- Printer
- Software
- Terminal Block Marking
- Cable and Conductor Marking
- Device Marking
- Marker Carriers

Volume 1, WAGO Rail-Mount Terminal Blocks and Connectors

			Page	
	WAGO Rail-Mount Terminal Blocks TOPJOB® S Front-Entry Wiring	Push-in CAGE CLAMP® 1 ... 16 (25 "f-st") mm ² / 16 ... 4 AWG for DIN-35 rail	25	1
	WAGO Rail-Mount Terminal Blocks with a Pluggable Connector X-COM®S-SYSTEM Front-Entry Wiring	Push-in CAGE CLAMP® 1 ... 2.5 (4) mm ² / 16 ... 12 AWG for DIN-35 rail	183	2
	WAGO Installation Rail-Mount Terminal Blocks TOPJOB® S Front-Entry Wiring	Push-in CAGE CLAMP® 1 ... 4 (6) mm ² / 16 ... 10 AWG for DIN-35 rail	225	3
	WAGO Miniature Rail-Mount Terminal Blocks TOPJOB® S Front-Entry Wiring	Push-in CAGE CLAMP® 0.14 ... 1 (1.5) mm ² / 24 ... 16 AWG for DIN-35 rail	245	4
	WAGO High-Current Rail-Mount Terminal Blocks Side-Entry Wiring	POWER CAGE CLAMP 35 ... 185 mm ² / 2 AWG ... 350 kcmil, 1500 V nominal voltage, for DIN-35 rail	255	5
	WAGO Rail-Mount Terminal Blocks "Classic" WAGO Installation Rail-Mount Terminal Blocks TOPJOB® "Classic" Front-Entry Wiring	CAGE CLAMP® 1.5 ... 35 mm ² / 16 ... 2 AWG for DIN-35 rail	269	6
	WAGO Rail-Mount Terminal Blocks with a Pluggable Connector X-COM®-SYSTEM Front-Entry Wiring	CAGE CLAMP® 2.5 (4) mm ² / 12 AWG for DIN-35 rail	387	7
	WAGO Rail-Mount Terminal Blocks "Mini" WAGO Rail-Mount Terminal Blocks "Compact" Front-Entry Wiring	CAGE CLAMP® 2.5 mm ² (4 mm ²) / 12 AWG for DIN-35 and DIN-15 rails	459	8
	WAGO Modular Terminal Blocks and WAGO Terminal Strips Side-/Front-Entry Wiring	CAGE CLAMP® 1.5 ... 4 mm ² / 16 ... 12 AWG for panel mounting	483	9
	WAGO Chassis-Mount Terminal Strips WAGO Field-Wiring Terminal Blocks Side-Entry Wiring	Push-in CAGE CLAMP® 2.5 mm ² / 22 AWG, 4 mm ² / 12 AWG for panel mounting	513	10
	WAGO Rail-Mount Terminal Blocks "Classic" Side-Entry Wiring	CAGE CLAMP® 1.5 ... 16 mm ² / 16 ... 6 AWG for DIN-35 rail	535	11
	WAGO Patchboard Systems WAGO Busbar Terminal Blocks	CAGE CLAMP® 1.5 ... 16 mm ² / 16 ... 6 AWG	547	12
	WAGO Splicing Connectors WAGO Lighting Connectors		571	13
	WAGO Accessories and WAGO Tools		621	14
	Technical Section		683	15
	Indexes and Addresses		733	16

Operating WAGO Connection Technologies

Please follow the applicable product-specific termination instructions.

PUSH-IN CAGE CLAMP®



Push-in CAGE CLAMP® terminates the following copper conductors:
solid



stranded



fine-stranded,
also with tinned
single strands



fine-stranded,
tip-bonded



fine-stranded,
with ferrule
(gastight crimped)



fine-stranded,
with pin terminal
(gastight crimped)

The universal connection with an additional advantage:

Push-in connection

Terminate solid and stranded (Class B 7 strands or less), as well as ferruled conductors, by simply pushing them in – no tools required.

Termination for all conductor types:

- Open clamping unit.
- Insert the conductor.
- Release clamp – done!

CAGE CLAMP®

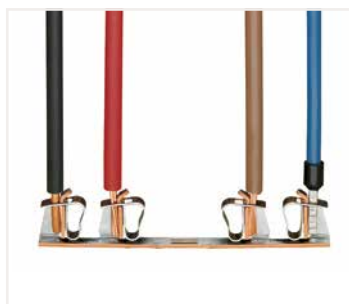

CAGE CLAMP® terminates the following copper conductors:
solid



stranded



fine-stranded,
also with tinned
single strands



fine-stranded,
tip-bonded



fine-stranded,
with ferrule
(gastight crimped)



fine-stranded,
with pin terminal
(gastight crimped)

The universal connection for solid, stranded and fine-stranded conductors

Termination:

- Open clamping unit.
- Insert the conductor.
- Release clamp – done!

Operating WAGO Connection Technologies

Please follow the applicable product-specific termination instructions.

POWER CAGE CLAMP®



POWER CAGE CLAMP terminates the following copper conductors:
solid



stranded



fine-stranded,
also with tinned
single strands



fine-stranded,
with ferrule
(gastight crimped)

The universal connection for conductors larger than 35 mm² (2 AWG)

Termination:

- Open clamp by turning a T-wrench counter-clockwise.
- Press the integrated latch to open clamping unit for hands-free wiring.
- Insert the conductor.
- A small counter-clockwise rotation closes the clamp, securing conductor.

PUSH WIRE®

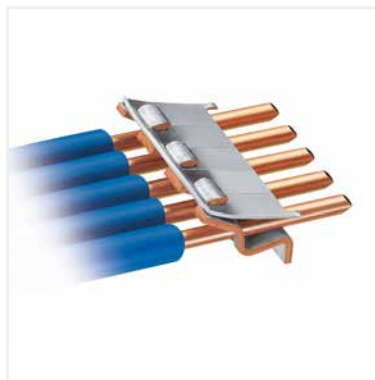
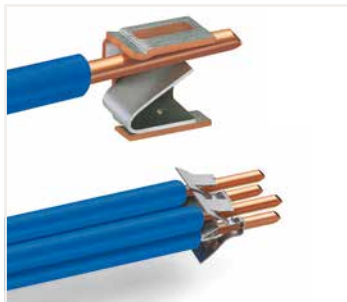

PUSH WIRE® terminates the following copper conductors:
solid

PUSH WIRE® connection for solid and stranded conductors (depending on the model used)

Termination:

Tool-free, twist-free terminations for solid and rigid stranded conductors – simply push into the unit.

Product Overview

WAGO Rail-Mount Terminal Blocks TOPJOB® S; with Push-in CAGE CLAMP® Connection

Through terminal blocks; with lever and Push-in CAGE CLAMP®



Page 28

Ground conductor terminal blocks; with lever and Push-in CAGE CLAMP®



Page 28

Through terminal blocks; with lever and push-button



Page 33

WAGO Rail-Mount Terminal Blocks TOPJOB® S; with Push-in CAGE CLAMP® Connection

Ground conductor terminal blocks; with lever and push-button



Page 33

Through terminal blocks; with push-button



Page 38

Ground conductor terminal blocks; with push-button

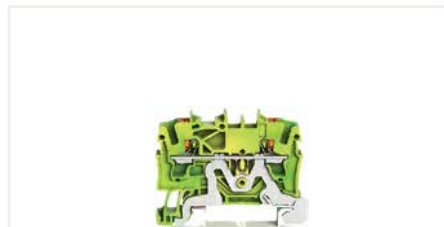

Page 38

WAGO Rail-Mount Terminal Blocks TOPJOB® S; with Push-in CAGE CLAMP® Connection

Through terminal blocks



Page 54

Ground conductor terminal blocks



Page 54

Shield terminal blocks



Page 56

WAGO Rail-Mount Terminal Blocks TOPJOB® S; with Push-in CAGE CLAMP® Connection

Double-potential terminal blocks

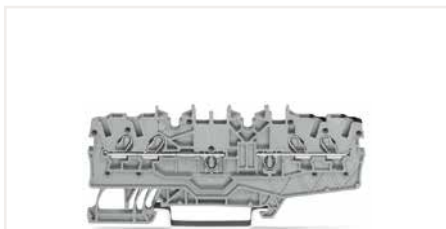

Page 55

Double-deck terminal blocks; with push-button



Page 70

Double-deck terminal blocks



Page 72

Product Overview

WAGO Rail-Mount Terminal Blocks TOPJOB® S; with Push-in CAGE CLAMP® Connection

Double-deck disconnect terminal blocks



Page 86

Double-deck carrier terminal blocks



Page 86

Double-deck fuse terminal blocks



Page 87

WAGO Rail-Mount Terminal Blocks TOPJOB® S; with Push-in CAGE CLAMP® Connection

Triple-deck terminal blocks



Page 88

Quadruple-deck rail-mount terminal blocks as rail-mount terminal blocks for electric motor wiring



Page 90

Disconnect and test terminal blocks; with push-button

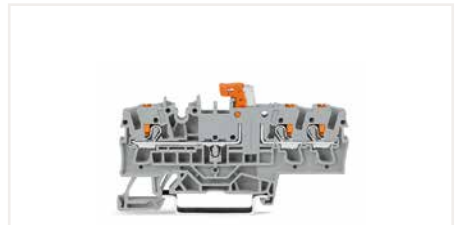

Page 92

WAGO Rail-Mount Terminal Blocks TOPJOB® S; with Push-in CAGE CLAMP® Connection

Fuse terminal blocks; with push-button; for mini-automotive blade-style fuse



Page 92

Fused disconnect terminal blocks with a pivoting fuse holder; with push-button



Page 102

Through terminal blocks; with push-button



Page 93

WAGO Rail-Mount Terminal Blocks TOPJOB® S; with Push-in CAGE CLAMP® Connection

Disconnect and test terminal blocks



Page 104

Fuse terminal blocks for mini-automotive blade-style fuses



Page 104

Fused disconnect terminal blocks with a pivoting fuse holder for glass cartridge fuses



Page 112

Product Overview

WAGO Rail-Mount Terminal Blocks TOPJOB® S; with Push-in CAGE CLAMP® Connection

Ground conductor disconnect terminal blocks



Page 116

Disconnect/test terminal blocks; for current and voltage transformer circuits



Page 128

Terminal Blocks Assembly; for Current and Voltage Transformers



Page 130

WAGO Rail-Mount Terminal Blocks TOPJOB® S; with Push-in CAGE CLAMP® Connection

Carrier terminal blocks; with push-button



Page 92

Carrier terminal blocks



Page 105

Fuse plugs on carrier terminal blocks



Page 132

WAGO Rail-Mount Terminal Blocks TOPJOB® S; with Push-in CAGE CLAMP® Connection

Sensor terminal blocks

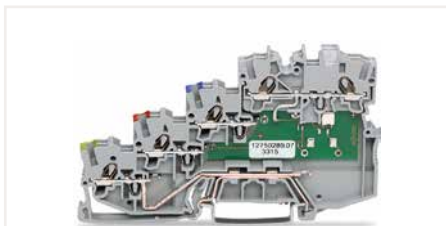

Page 138

Actuator terminal blocks



Page 140

Sensor and actuator supply terminal blocks



Page 138

WAGO Rail-Mount Terminal Blocks TOPJOB® S; with Push-in CAGE CLAMP® Connection

Sensor terminal blocks; with a pluggable signal level



Page 143

Actuator terminal blocks; with a pluggable signal level

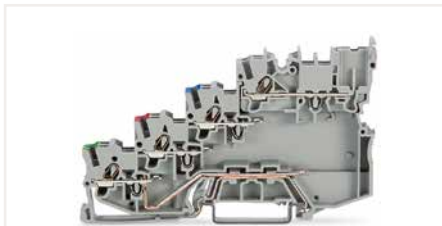

Page 145

Sensor and actuator supply terminal blocks; with a pluggable signal level



Page 143

Product Overview

WAGO Rail-Mount Terminal Blocks TOPJOB® S; with Push-in CAGE CLAMP® Connection

Diode terminal blocks



Page 146

LED terminal blocks



Page 146

Empty component plug housings



Page 153

WAGO Rail-Mount Terminal Blocks TOPJOB® S; with Push-in CAGE CLAMP® Connection

Diode modules



Page 152

LED modules



Page 154

Component plugs



Page 158

WAGO Rail-Mount Terminal Blocks TOPJOB® S; with Push-in CAGE CLAMP® Connection

Double-deck disconnect/test terminal blocks



Page 160

Double-deck carrier terminal blocks

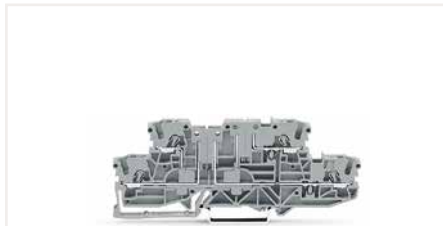

Page 162

Multilevel diode terminal blocks and LED terminal blocks



Page 164

WAGO Rail-Mount Terminal Blocks with a Pluggable Connector, X-COM®S-SYSTEM-MINI

Carrier terminal blocks



Page 186

Ground carrier terminal blocks



Page 186

Double-deck carrier terminal blocks



Page 188

Product Overview

WAGO Rail-Mount Terminal Blocks with a Pluggable Connector, X-COM®S-SYSTEM-MINI

1-conductor female plugs

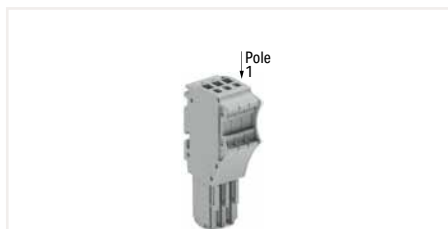

Page 190

2-conductor female plugs

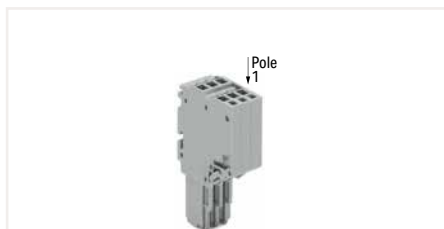

Page 190

Female plugs for self-assembly



Page 192

WAGO Rail-Mount Terminal Blocks with a Pluggable Connector, X-COM®S-SYSTEM-MINI

Pre-assembled female plugs

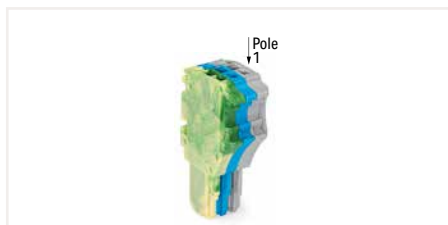

Page 194

1-conductor female plugs; with locking levers and strain relief plates



Page 198

2-conductor female plugs; with locking levers and strain relief plates

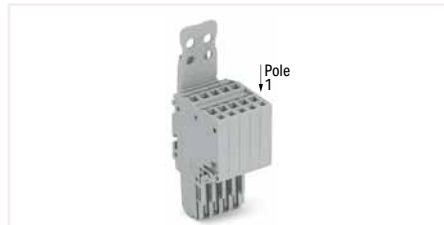

Page 200

WAGO Rail-Mount Terminal Blocks with a Pluggable Connector, X-COM®S-SYSTEM

Carrier terminal blocks



Page 202

Ground carrier terminal blocks



Page 202

Carrier terminal blocks

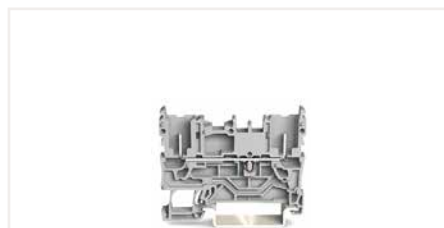

Page 204

WAGO Rail-Mount Terminal Blocks with a Pluggable Connector, X-COM®S-SYSTEM

Ground carrier terminal blocks

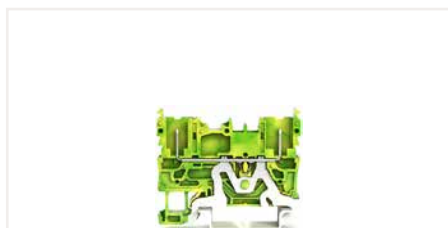

Page 204

Double-deck carrier terminal blocks



Page 206

Female plugs

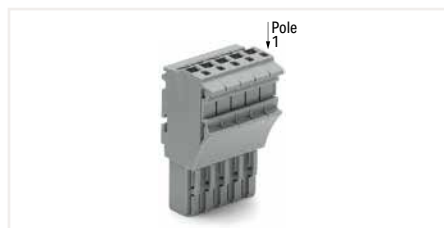

Page 208

Product Overview

WAGO Rail-Mount Terminal Blocks with a Pluggable Connector, X-COM®S-SYSTEM

Female plugs for self-assembly



Page 210

Pre-assembled female plugs

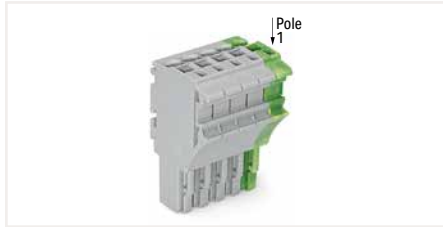

Page 212

Female plugs; with locking levers and strain relief plates



Page 214

WAGO Rail-Mount Terminal Blocks with a Pluggable Connector, X-COM®S-SYSTEM; for Ex applications

Carrier terminal blocks; for Ex ec applications

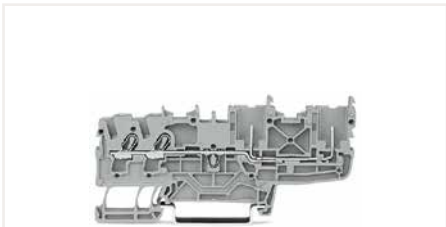

Page 216

Ground carrier terminal blocks; for Ex ec applications



Page 216

Carrier terminal blocks; for Ex ec applications



Page 218

WAGO Rail-Mount Terminal Blocks with a Pluggable Connector, X-COM®S-SYSTEM; for Ex applications

Double-deck carrier terminal blocks; for Ex ec applications

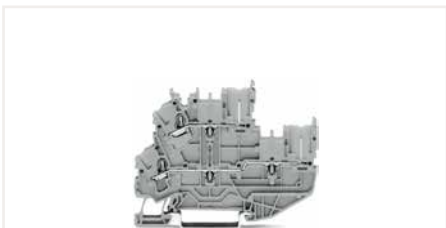

Page 220

Female plugs; for Ex ec applications



Page 222

Pre-assembled female plugs; for Ex ec applications



Page 223

WAGO Installation Rail-Mount Terminal Blocks TOPJOB® S; with Push-in CAGE CLAMP® Connection

Multilevel installation terminal blocks; with an N-disconnect slide link; 2.5 (4) mm²



Page 228

Multilevel installation terminal blocks; with an internal N-disconnection

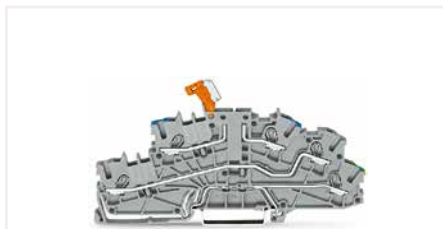

Page 230

Double-fuse plugs



Page 234

Product Overview

WAGO Installation Rail-Mount Terminal Blocks TOPJOB® S; with Push-in CAGE CLAMP® Connection

Multilevel installation terminal blocks; with an N-disconnect slide link; 4 (6) mm² (10 AWG)



Page 236

N-conductor disconnect terminal blocks and power distribution disconnect terminal blocks



Page 238

Supply terminal blocks for distribution boxes



Page 240

WAGO Installation Rail-Mount Terminal Blocks TOPJOB® S; with Push-in CAGE CLAMP® Connection

Mminiature through terminal blocks; with push-button; for DIN-15 rail



Page 248

Mminiature ground conductor terminal blocks; with push-button; for DIN-15 rail

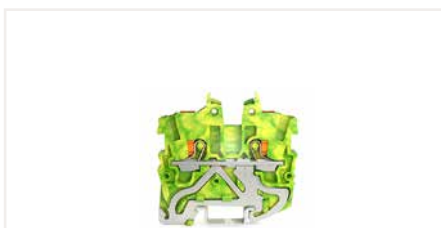

Page 248

Mminiature through terminal blocks; with push-button; with mounting flange or snap-in mounting foot

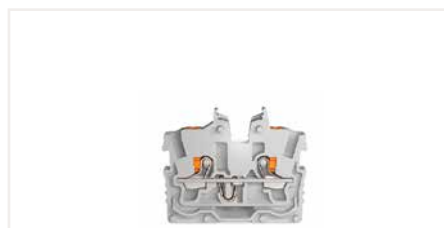

Page 250

WAGO Installation Rail-Mount Terminal Blocks TOPJOB® S; with Push-in CAGE CLAMP® Connection

Mminiature through terminal blocks; with push-button; for DIN-15 rail



Page 249

Mminiature ground conductor terminal blocks; with push-button; for DIN-15 rail



Page 249

Mminiature through terminal blocks; with push-button; with mounting flange or snap-in mounting foot



Page 252

WAGO High-Current Rail-Mount Terminal Blocks

Through terminal blocks; 35 mm² (2 AWG)



Page 258

Ground conductor terminal blocks; 35 mm² (2 AWG)



Page 258

Power taps; for high-current terminal blocks 35 mm² (2 AWG)



Page 258

Product Overview

WAGO High-Current Rail-Mount Terminal Blocks

Through terminal blocks; 50 mm² (1/0 AWG)



Page 262

Ground conductor terminal blocks; 50 mm² (1/0 AWG)



Page 262

Power taps; for high-current terminal blocks 50 mm² (1/0 AWG)



Page 262

WAGO High-Current Rail-Mount Terminal Blocks

Through terminal blocks with mounting flanges; 50 mm² (1/0 AWG)



Page 263

Through terminal blocks with mounting flanges; 50 mm² (1/0 AWG)



Page 263

WAGO High-Current Rail-Mount Terminal Blocks

Through terminal blocks; 95 mm² (4/0 AWG)



Page 264

Ground conductor terminal blocks; 95 mm² (4/0 AWG)



Page 264

Power taps; for high-current terminal blocks 95 mm² (4/0 AWG)



Page 264

WAGO High-Current Rail-Mount Terminal Blocks

Through terminal blocks with mounting flanges; 95 mm² (4/0 AWG)



Page 265

Through terminal blocks with mounting flanges; 95 mm² (4/0 AWG)



Page 265

Product Overview

WAGO High-Current Rail-Mount Terminal Blocks

Through terminal blocks; 185 mm² (350 kcmil)



Page 266

Ground conductor terminal blocks; 185 mm² (350 kcmil)



Page 266

Power taps; for high-current terminal blocks 185 mm² (350 kcmil)



Page 266

WAGO High-Current Rail-Mount Terminal Blocks

Through terminal blocks with mounting flanges; 185 mm² (350 kcmil)



Page 267

Through terminal blocks with mounting flanges; 185 mm² (350 kcmil)



Page 267

WAGO Rail-Mount Terminal Blocks, Classic; with CAGE CLAMP® Connection Front-Entry Wiring

Through terminal blocks



Page 272

Ground conductor terminal blocks

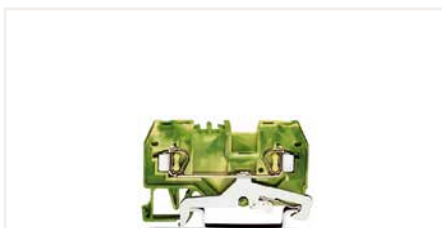

Page 272

Shield terminal blocks



Page 272

WAGO Rail-Mount Terminal Blocks, Classic; with CAGE CLAMP® Connection Front-Entry Wiring

Double-potential terminal blocks



Page 273

Distribution terminal blocks



Page 285

Double-deck terminal blocks



Page 288

Product Overview

WAGO Rail-Mount Terminal Blocks, Classic; with CAGE CLAMP® Connection Front-Entry Wiring

Triple-deck terminal blocks



Page 298

Quadruple-deck rail-mount terminal blocks as rail-mount terminal blocks for electric motor wiring

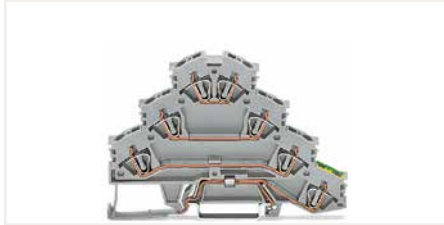

Page 300

Double- and triple-deck carrier terminal blocks; for fuse plug



Page 294

WAGO Rail-Mount Terminal Blocks, TOPJOB® Classic; with CAGE CLAMP® Connection

Through terminal blocks



Page 303

Ground conductor terminal blocks



Page 303

N-conductor disconnect terminal blocks and power distribution disconnect terminal blocks



Page 307

WAGO Rail-Mount Terminal Blocks, Classic; with CAGE CLAMP® Connection Front-Entry Wiring

Disconnect and test terminal blocks



Page 312

Disconnect and test terminal blocks



Page 314

Disconnect/test terminal blocks; for current and voltage transformer circuits

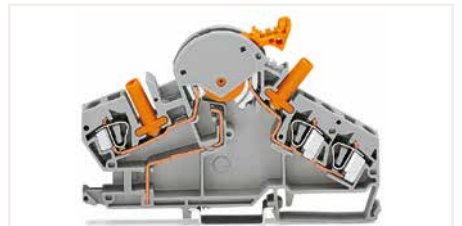

Page 322

WAGO Rail-Mount Terminal Blocks, Classic; with CAGE CLAMP® Connection Front-Entry Wiring

Ground conductor disconnect terminal blocks



Page 328

Fuse terminal blocks for mini-automotive blade-style fuses

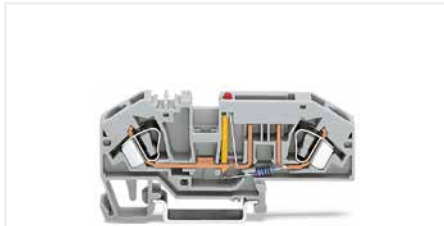

Page 330

Fuse plugs on carrier terminal blocks



Page 338

Product Overview

WAGO Rail-Mount Terminal Blocks, Classic; with CAGE CLAMP® Connection Front-Entry Wiring

Fused disconnect terminal blocks with a pivoting fuse holder for glass cartridge fuses



Page 334

Fuse terminal blocks; for Class CC fuses and 10 x 38 mm (1½" x 1½") cylindrical fuses



Page 342

Sensor and actuator terminal blocks



Page 348

WAGO Rail-Mount Terminal Blocks, Classic; with CAGE CLAMP® Connection Front-Entry Wiring

Diode terminal blocks



Page 364

LED terminal blocks



Page 364

Multilevel diode terminal blocks and LED terminal blocks



Page 370

WAGO Rail-Mount Terminal Blocks, Classic; with CAGE CLAMP® Connection Front-Entry Wiring

Diode modules



Page 374

LED modules



Page 376

WAGO Rail-Mount Terminal Blocks with a Pluggable Connector, X-COM®-SYSTEM

Carrier terminal blocks



Page 394

Ground carrier terminal blocks



Page 394

Disconnect carrier terminal blocks



Page 406

Product Overview

WAGO Rail-Mount Terminal Blocks with a Pluggable Connector, X-COM®-SYSTEM

Diode carrier terminal blocks

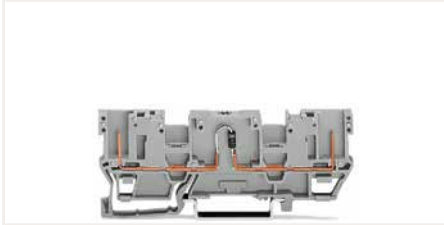

Page 408

LED carrier terminal blocks

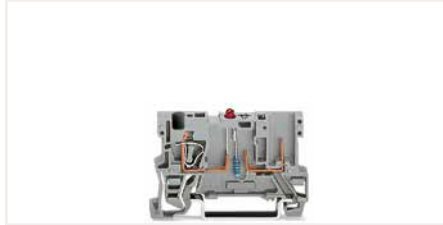

Page 410

Carrier terminal blocks; for pluggable modules

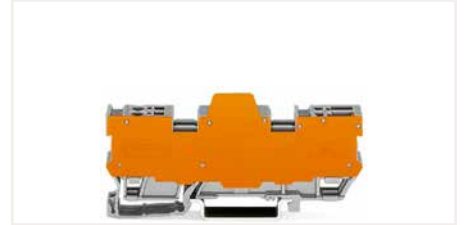

Page 416

WAGO Rail-Mount Terminal Blocks with a Pluggable Connector, X-COM®-SYSTEM

Double-deck carrier terminal blocks



Page 424

Male connectors; with CAGE CLAMP® connection



Page 434

Male headers; with solder pins



Page 438

WAGO Rail-Mount Terminal Blocks with a Pluggable Connector, X-COM®-SYSTEM

Female plugs; with/without lateral locking lever

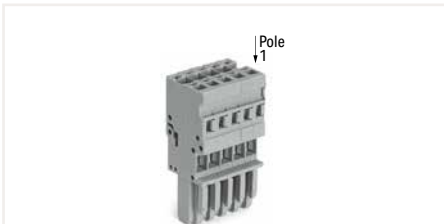

Page 444

Female plugs for self-assembly



Page 448

Pre-assembled female plugs

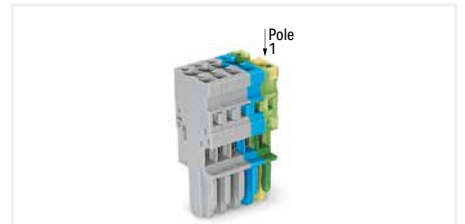

Page 450

WAGO Rail-Mount Terminal Blocks, Mini; with CAGE CLAMP® Connection

Through terminal blocks; for DIN-35 rail



Page 462

Ground conductor terminal blocks; for DIN-35 rail



Page 462

Through terminal blocks Ex e II; for DIN-15 rail



Page 462

Product Overview

WAGO Rail-Mount Terminal Blocks, Mini; with CAGE CLAMP® Connection

Through terminal blocks; for DIN-15 rail



Page 463

Ground conductor terminal blocks; for DIN-15 rail

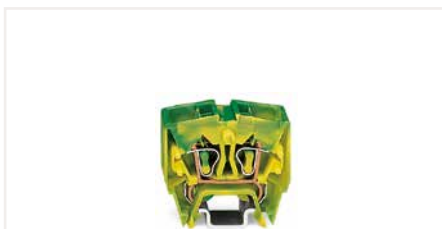

Page 463

Through terminal blocks Ex e II; for DIN-15 rail

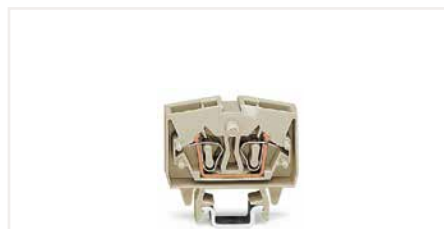

Page 463

WAGO Rail-Mount Terminal Blocks, Compact; with CAGE CLAMP COMPACT Connection

Through terminal blocks; for DIN-35 rail

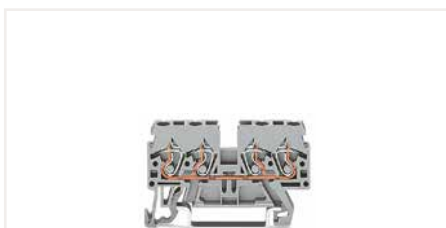

Page 466

Ground conductor terminal blocks; for DIN-35 rail

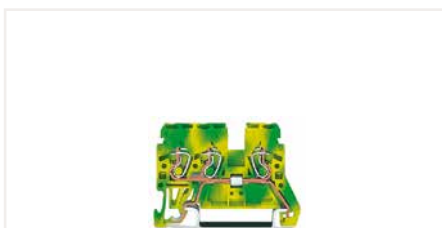

Page 466

Through terminal blocks Ex e II; for DIN-15 rail

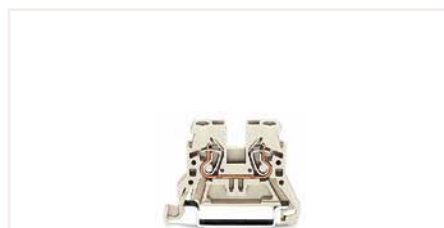

Page 466

WAGO Rail-Mount Terminal Blocks, Compact; with CAGE CLAMP COMPACT Connection

Through terminal blocks; for DIN-15 rail

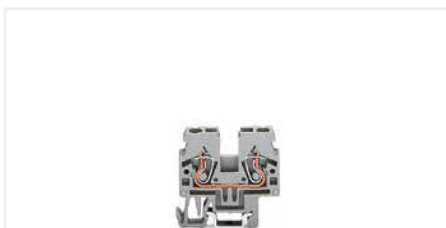

Page 467

Ground conductor terminal blocks; for DIN-15 rail

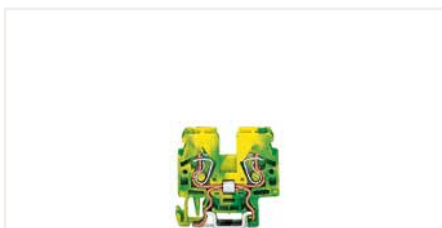

Page 467

Through terminal blocks Ex e II; for DIN-15 rail

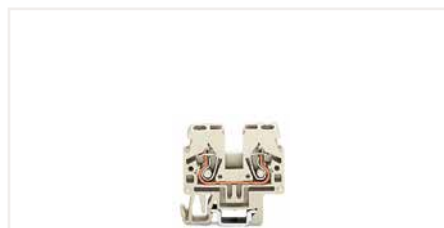

Page 467

WAGO Rail-Mount Terminal Blocks, Compact; with CAGE CLAMP COMPACT Connection

Double-potential terminal blocks



Page 467

Double-deck terminal blocks



Page 468

Triple-deck terminal blocks



Page 470

Product Overview

WAGO Rail-Mount Terminal Blocks, Compact; with CAGE CLAMP COMPACT Connection

Multilevel diode and LED terminal blocks



Page 472

Pluggable tap-off modules



Page 477

Sensor and actuator terminal blocks



Page 479

WAGO Modular Terminal Blocks and WAGO Terminal Strips

Modular terminal blocks

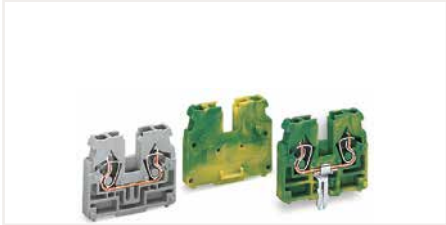

Page 486

Terminal strips; with mounting flanges



Page 485

Terminal strips; with snap-in mounting feet



Page 485

WAGO Modular Terminal Blocks and WAGO Terminal Strips

Modular terminal blocks



Page 490

Terminal strips; with mounting flanges



Page 492

Terminal strips; with snap-in mounting feet



Page 492

WAGO Modular Terminal Blocks and WAGO Terminal Strips

Modular terminal blocks



Page 496

Terminal strips; with mounting flanges



Page 497

Terminal strips; with snap-in mounting feet



Page 497

Product Overview

WAGO Chassis-Mount Terminal Strips WAGO Field-Wiring Terminal Blocks

4-conductor chassis-mount terminal strips



Page 516

Field-wiring terminal blocks



Page 525

WAGO Rail-Mount Terminal Blocks, Classic; with CAGE CLAMP® Connection Side-Entry Wiring

Through terminal blocks



Page 538

Ground conductor terminal blocks



Page 538

Disconnect and test terminal blocks



Page 542

WAGO Rail-Mount Terminal Blocks, Classic; with CAGE CLAMP® Connection Side-Entry Wiring

Ground conductor disconnect terminal blocks

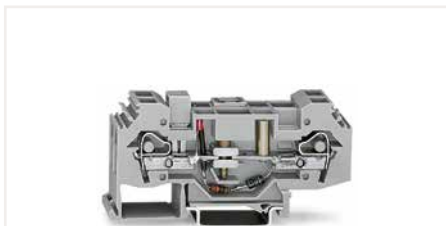

Page 543

Fused disconnect terminal blocks; for glass cartridge fuses



Page 544

WAGO Patchboard Systems

Matrix patchboards



Page 550

Matrix patchboards; with push-buttons



Page 557

Additional modules



Page 558

Product Overview

WAGO Patchboard Systems

Terminal blocks for matrix patching



Page 562

Common potential terminal blocks



Page 563

3-conductor, double-potential terminal blocks or terminal blocks for matrix patching



Page 567

WAGO Busbar Terminal Blocks

Busbar terminal blocks



Page 569

Ground busbar terminal blocks



Page 569

Insulated busbar carriers



Page 569

WAGO PUSH WIRE® Connectors for Junction Boxes

COMPACT PUSH WIRE® connector for junction boxes



Page 573

COMPACT PUSH WIRE® connector for junction boxes



Page 573

Mounting carriers



Page 573

WAGO PUSH WIRE® Connectors for Junction Boxes

PUSH WIRE® connectors for junction boxes



Page 576

Ex PUSH WIRE® connectors for junction boxes



Page 578

Mounting carriers



Page 575

Product Overview

WAGO PUSH WIRE® Connectors for Junction Boxes

MICRO PUSH WIRE® connectors for junction boxes



Page 582

MICRO PUSH WIRE® connectors for junction boxes



Page 582

Mounting carriers



Page 583

WAGO Splicing Connectors for All Conductor Types

COMPACT splicing connectors for all conductor types;
4 mm²/12 AWG



Page 585

Mounting carriers



Page 587

Mounting carrier; for 4 mm²/12 AWG single connectors



Page 589

WAGO Splicing Connectors for All Conductor Types

COMPACT splicing connectors for all conductor types;
4 mm²/12 AWG; for Ex eb applications



Page 594

Mounting carriers; for Ex eb applications



Page 594

Gelboxes; for splicing connectors



Page 599

WAGO Splicing Connectors for All Conductor Types

COMPACT splicing connectors for all conductor types;
6 mm²/10 AWG



Page 591

Mounting carriers



Page 591

COMPACT splicing connectors for all conductor types;
6 mm²/10 AWG; for Ex eb applications



Page 595

Product Overview

WAGO Splicing Connectors

Junction boxes; for 221 Series Splicing Connectors (4 mm²)



Page 603

WAGO Splicing Connectors

Inline Splicing Connectors



Page 605

Mounting carriers



Page 607

WAGO Splicing Connectors for All Conductor Types

CLASSIC splicing connectors for all conductor types



Page 609

Mounting carriers



Page 611

WAGO Lighting Connectors

Luminaire disconnect connectors



Page 618

WAGO Lighting Connectors

Lighting connectors



Page 613

Lighting connectors



Page 613

"Service" connectors



Page 613

WAGO Splicing Connector Set

Vario-T-BOXX



Page 614

L-BOXX® 102



Page 614

Splicing connector sets



Page 616

Product Overview

WAGO Shield Connection System

Shield clamping saddles



Page 624

Shield clamping saddles



Page 627

Busbar carriers



Page 629

WAGO Marking Systems

Marker cards



Page 640

WMB Inline markers

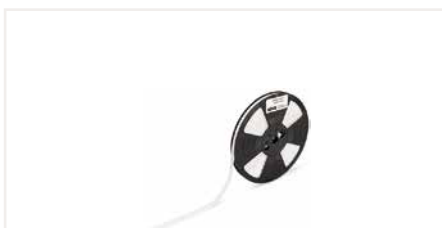

Page 640

Marking strips



Page 640

WAGO Marking Systems

Marker carriers

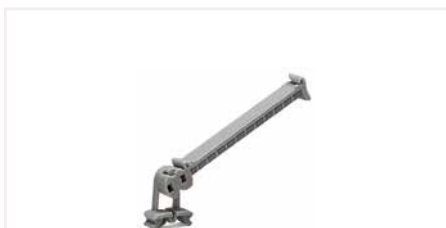

Page 651

Marker carriers



Page 649

Marking cards; self-adhesive marking strips



Page 642

WAGO Mounting Accessories

Screwless end stops; DIN-35 rail



Page 658

DIN-35 rails



Page 656

Collective jumper carriers



Page 657

Product Overview

WAGO Mounting Accessories

Covers



Page 661

Screwless end stops; DIN-15 rail



Page 663

DIN-15 rails



Page 663

WAGO Tools

Operating tools



Page 664

Operating tools



Page 664

Operating tools



Page 665

WAGO Tools

Cable cutter



Page 676

Cable stripper



Page 666

Wire strippers



Page 669

WAGO Tools

Crimping tools



Page 670

Ferrules



Page 671

Measurement devices



Page 678

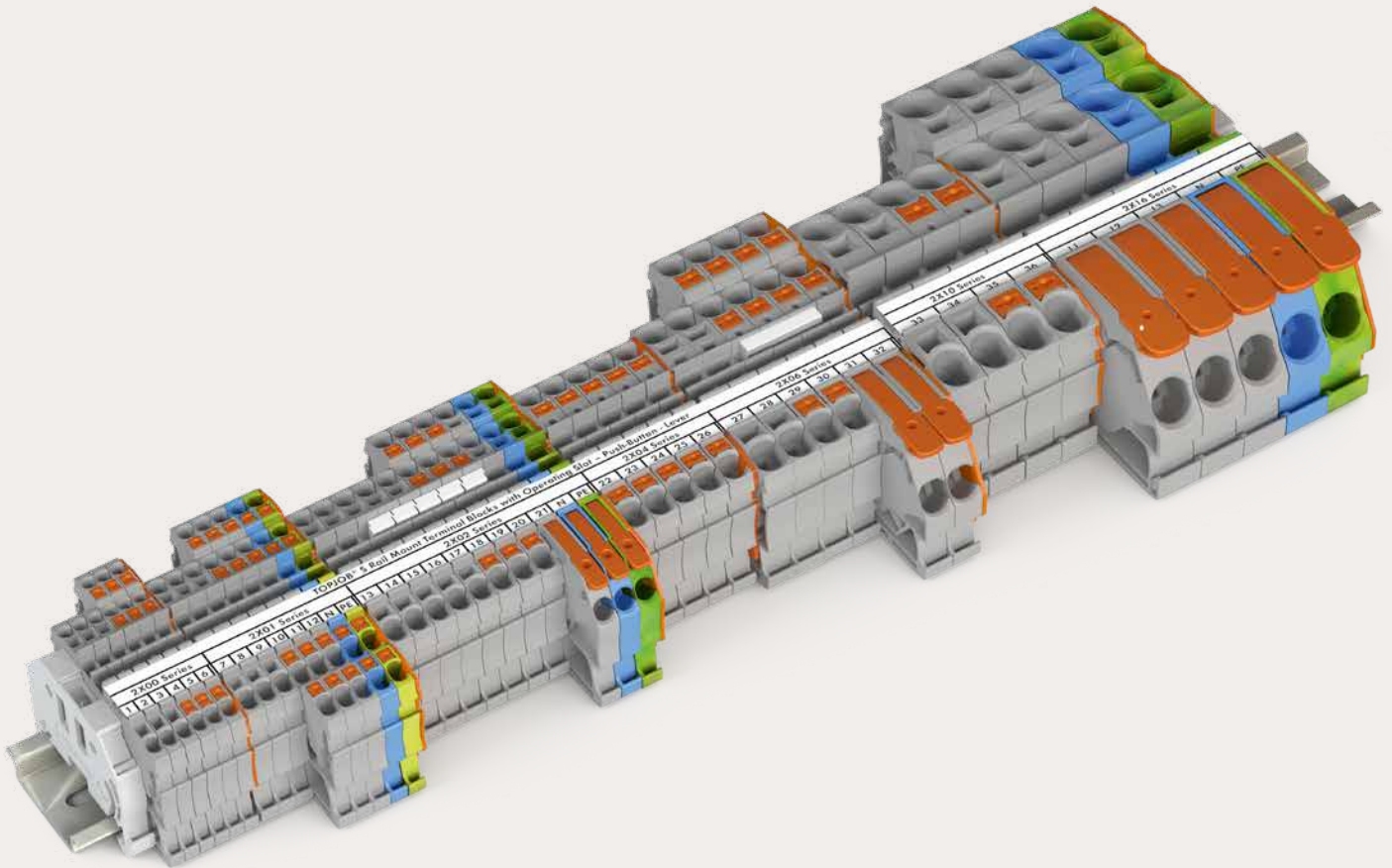

WAGO Rail-Mount Terminal Blocks TOPJOB® S

WAGO Rail-Mount Terminal Blocks TOPJOB® S

Front-Entry Wiring

			Page
	Through Terminal Blocks and Ground Conductor Terminal Blocks; with Levers and Push-in CAGE CLAMP®	2102 ... 2116 Series	28
	Through Terminal Blocks and Ground Conductor Terminal Blocks; with Levers and Push-Buttons 0.25 ... 16 (25 "f-st") mm ² (22 ... 4 AWG)	2102 ... 2116 Series	33
	Through Terminal Blocks and Ground Conductor Terminal Blocks; with Push-Buttons 0.14 ... 16 (25 "f-st") mm ² (24 ... 4 AWG)	2200 ... 2216 Series	38
	Through Terminal Blocks, Ground Conductor Terminal Blocks and Shield Conductor Terminal Blocks 0.14 ... 16 (25 "f-st") mm ² (24 ... 4 AWG)	2000 ... 2016 Series	54
	Multilevel Rail-Mount Terminal Blocks; with/without Push-Buttons 1 (1.5) mm ² (16 AWG) and 2.5 (4) mm ² (12 AWG)	2202/2000/2002 Series	70
	Disconnect/Test Terminal Blocks, Fuse Terminal Blocks and Through Terminal Blocks; with/without Push-Buttons 0.25 ... 2.5 (4) mm ² (22 ... 12 AWG)	2202/2002 Series	92
	Fused Disconnect Terminal Blocks with a Pivoting Fuse Holder; with/without Push-Buttons 0.25 ... 2.5 (4) mm ² (22 ... 12 AWG)	2202/2002 Series	102
	Disconnect Terminal Blocks, Ground Conductor Disconnect Terminal Blocks and Fuse Terminal Blocks 0.5 ... 6 (10) mm ² (20 ... 8 AWG)	2006 Series	116
	Disconnect/Test Terminal Blocks; for Current and Voltage Transformer Circuits 0.5 ... 6 (10) mm ² (20 ... 8 AWG)	2007 Series	128
	Fuse Plugs on Carrier Terminal Blocks	2004/2006 Series	132
	Sensor Terminal Blocks and Actuator Terminal Blocks 0.14 ... 1 (1.5) mm ² (24 ... 16 AWG)	2000/2020 Series	138
	Diode Terminal Blocks and LED Terminal Blocks 0.25 ... 4 (6) mm ² (22 ... 10 AWG)	2001/2002/2004 Series	148
	Multilevel Diode Terminal Blocks and LED Terminal Blocks 0.25 ... 2.5 (4) mm ² (22 ... 12 AWG)	2002 Series	164
	Diode Modules, LED Modules and Empty Component Plugs Housing	2002 Series	152
	Accessories for Rail-Mount Terminal Blocks TOPJOB® S		168

Rail-Mount Terminal Blocks TOPJOB® S; with Levers and Push-in CAGE CLAMP® 2102, 2106, 2110 and 2116 Series Description and Installation

1

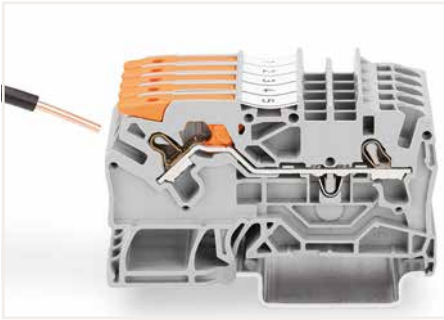

Push-in termination of solid conductors

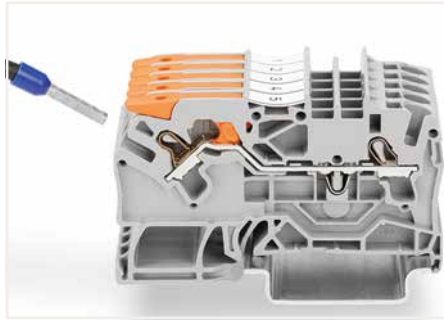

Push-in termination of fine-stranded conductors with ferrules

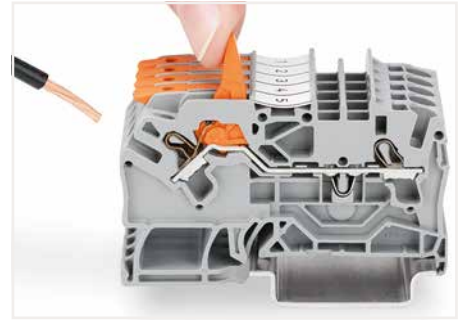

Pull the lever up until it stops, then connect the fine-stranded conductor.

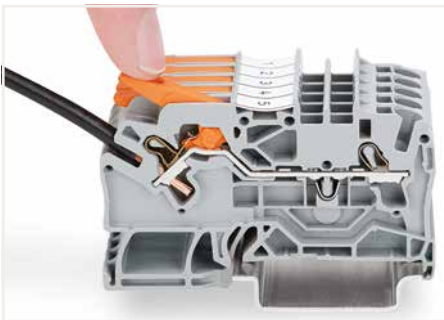

Push the lever back down – done!



Insert push-in type jumper bar and push down until it hits backstop.

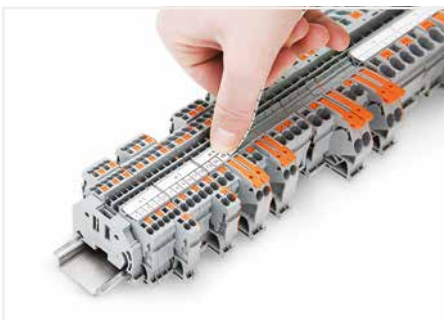
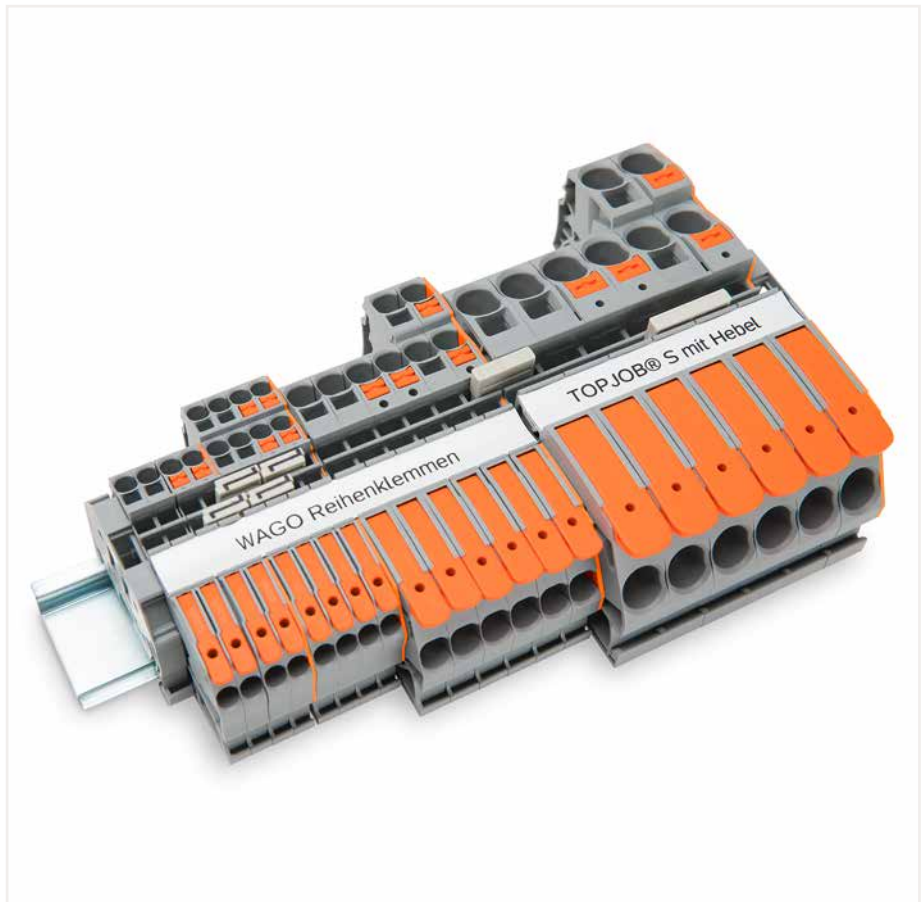

Snapping a marking strip into the marker slot.



Snapping a marking strip into the marker slot.

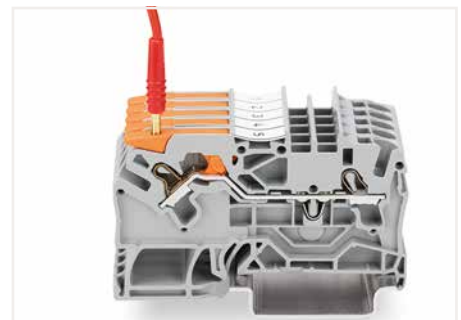

Testing with a 2 mm Ø test plug (max. 42 V).



Push-in CAGE CLAMP® terminates the following copper conductors:
solid "s"



stranded "st"



fine-stranded "f-st", also with tinned single strands

PUSH-IN CAGE CLAMP®

Rail-Mount Terminal Blocks TOPJOB® S; with Push-Buttons and Push-in CAGE CLAMP®

2200 to 2216 Series

Description and Installation

1



Push-in termination of solid and ferruled conductors



Insert fine-stranded conductors via operating tool.



Removing all conductors via operating tool.

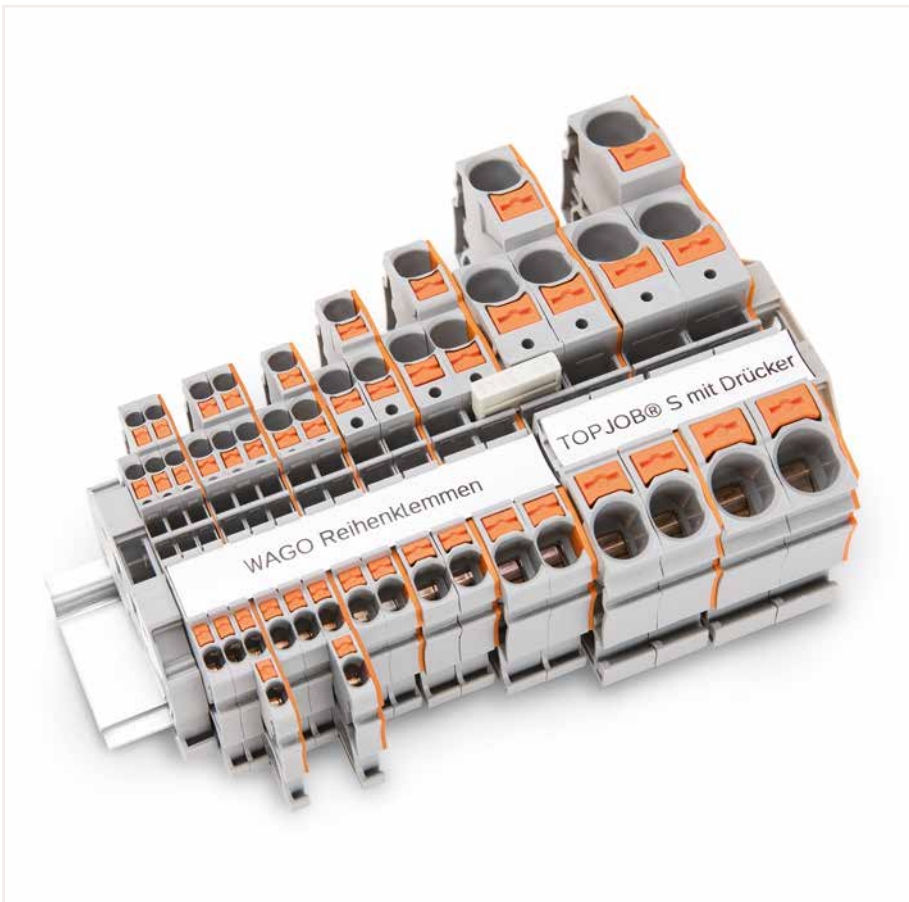

Insert push-in type jumper bar and push down until it hits backstop.



Commoning with step-down jumpers.

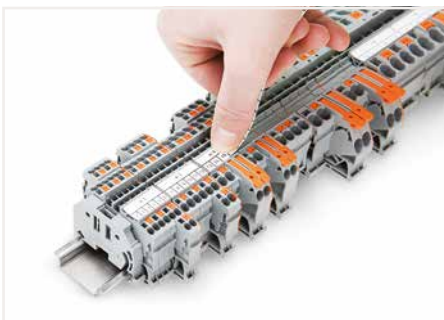

Snapping a marking strip into the marker slot.



Snapping a marking strip into the marker slot.



Testing with a 2 mm Ø test plug (max. 42 V).



fine-stranded, tip-bonded



fine-stranded, with ferrule (gastight crimped)



fine-stranded, with pin terminal (gastight crimped)

PUSH-IN CAGE CLAMP®

Through Terminal Block, Ground Conductor Terminal Block TOPJOB® S; with Lever and Push-in CAGE CLAMP® 2.5 (4) mm²; 2102 Series

1

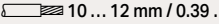
Technical Data	
0.25 ... 2.5 (4) mm ² ①	22 ... 12 AWG
800 V/8 kV/3 ②	600 V, 20 A ③
I _N 24 A (32 A)	600 V, 20 A ④
Terminal block width: 5.2 mm / 0.205 inch	
 10 ... 12 mm / 0.39 ... 0.47 inch	

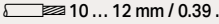
Technical Data	
0.25 ... 2.5 (4) mm ² ①	22 ... 12 AWG
800 V/8 kV/3 ②	600 V, 20 A ③
I _N 24 A (30 A)	600 V, 20 A ④
Terminal block width: 5.2 mm / 0.205 inch	
 10 ... 12 mm / 0.39 ... 0.47 inch	

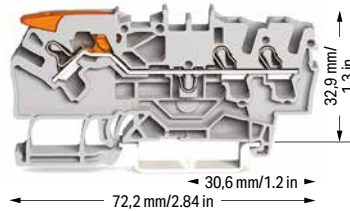
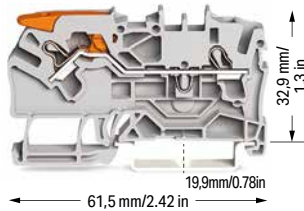



2-conductor through terminal block; with lever and Push-in CAGE CLAMP®		
Color	Item No.	Pack. Unit
gray ⑤	2102-1201 ④	50
blue ⑤	2102-1204 ③ ④	50

3-conductor through terminal block; with lever and Push-in CAGE CLAMP®		
Color	Item No.	Pack. Unit
gray ⑤	2102-1301 ④	50
blue ⑤	2102-1304 ③ ④	50

2-conductor ground terminal block; with lever and Push-in CAGE CLAMP®		
green-yellow ⑤	2102-1207 ④	50

3-conductor ground terminal block; with lever and Push-in CAGE CLAMP®		
green-yellow ⑤	2102-1307 ④	50

Accessories; item-specific			
End and intermediate plate; 0.8 mm thick			
	orange	2102-1292	100 (25)
	gray	2102-1291	100 (25)

Accessories; item-specific			
End and intermediate plate; 0.8 mm thick			
	orange	2102-1392	100 (25)
	gray	2102-1391	100 (25)

Accessories; 2102 Series
Appropriate marking systems: WMB/WMB Inline/Marking strips

Insulation stop; 5 pcs/strip; 0.25 ... 0.5 mm ²			
	light gray	2002-171	200 (25)

Push-in type jumper bar; insulated; I _N 25 A; light gray			
	1 to 3	2002-433	25
	1 to 4	2002-434	25
	1 to 5	2002-435	25
	1 to 6	2002-436	25
	1 to 7	2002-437	25
	1 to 8	2002-438	25
	1 to 9	2002-439	25
	1 to 10	2002-440	25

Insulation stop; 5 pcs/strip; 0.75 ... 1 mm ²			
	dark gray	2002-172	200 (25)

Protective warning marker; with black high-voltage symbol; for 5 terminal blocks			
	yellow	2002-115	100 (25)

Adjacent jumper for continuous commoning; insulated; I _N 25 A, light gray			
	2-way	2002-400	25

Push-in type jumper bar; insulated; I _N 25 A; light gray			
	2-way	2002-402	25
	3-way	2002-403	25
	4-way	2002-404	25
	5-way	2002-405	25
	6-way	2002-406	25
	7-way	2002-407	25
	8-way	2002-408	25
	9-way	2002-409	25
	10-way	2002-410	25

Adjacent jumper for continuous commoning; insulated; I _N 25 A; 1 to 3			
	light gray	2002-423	25
	red	2002-423/000-005	25
	blue	2002-423/000-006	25

Delta jumper; insulated; I _N = I _N terminal block; light gray			
	1-2 3-4 5-6	2002-406/020-000	25

Push-in type wire jumper; insulated; 1.5 mm ² conductor cross-section; I _N 18 A			
	L = 60 mm	2009-412	100 (10)
	L = 110 mm	2009-414	100 (10)
	L = 250 mm	2009-416	100 (10)

Star point jumper; insulated; I _N = I _N terminal block; light gray			
	1-3-5	2002-405/011-000	25

- ① Conductor range: 0.25 ... 4 mm² "s+f-st"; Push-in termination: 1 ... 4 mm² "s" and 1 ... 2.5 mm² "insulated ferrules, 12 mm"
Depending on the conductor characteristic, a conductor with a smaller cross section can also be inserted via push-in termination.
- ② 800 V = rated voltage
8 kV = rated impulse voltage
3 = pollution degree (see Section 15)
- ③ Terminal blocks with a blue insulated housing are suitable for Ex i applications.
- ④ Terminal blocks with an Ex mark are suitable for Ex e II applications.
550 V; 23.5 A
20 A jumper (see Section 15)

Please observe the application notes:
Jumpers, from page 174
Testing accessories, from page 169
Marking, from page 640

Approvals and corresponding ratings, visit www.wago.com

Accessories; 2102 Series
Appropriate marking systems:
WMB/WMB Inline/Marking strips

Staggered jumper; insulated; I _N 25 A; light gray			
	2-way	2002-472	25
	3-way	2002-473	25
	4-way	2002-474	25
	5-way	2002-475	25
	6-way	2002-476	25
	7-way	2002-477	25
	8-way	2002-478	25
	9-way	2002-479	25
	10-way	2002-480	25
	11-way	2002-481	25
	12-way	2002-482	25

Customized staggered jumper; insulated; with contact lugs broken off at the factory and circuit printing; I _N 25 A; light gray			
	1-3	2002-473/011-000	25
	1-3-5	2002-475/011-000	25
	1-3-5-7	2002-477/011-000	25
	1-3-5-7-9	2002-479/011-000	25
	1-3-5-7-9-11	2002-481/011-000	25

Modular connector; snaps together; for jumper contact slot			
	gray	2002-511	100 (25)

L-type test plug module; snaps together			
	gray	2002-611	100 (25)

Marking strip; plain; 11 mm wide; 50 m reel			
	white	2009-110	1

WMB Inline, plain; 1,500 WMB markers (5 mm)/reel; 5 ... 5.2 mm stretchable			
	white	2009-115	1

WMB marking card; white; 10 strips with 10 markers/card; 5 ... 5.2 mm stretchable			
	plain	793-5501	5

Through and Ground Conductor Terminal Block TOPJOB® S; with Lever and Push-in CAGE CLAMP®

4 (6) mm²; 2104 Series

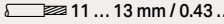
Technical Data	
0.5 ... 4 (6) mm ² ①	20 ... 10 AWG
800 V/8 kV/3 ②	600 V, 30 A ③
I _N 32 A (40 A)	600 V, 30 A ④
Terminal block width: 6.2 mm / 0.244 inch	
 11 ... 13 mm / 0.43 ... 0.51 inch	

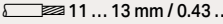
Technical Data	
0.5 ... 4 (6) mm ² ①	20 ... 10 AWG
800 V/8 kV/3 ②	600 V, 30 A ③
I _N 32 A (40 A)	600 V, 30 A ④
Terminal block width: 6.2 mm / 0.244 inch	
 11 ... 13 mm / 0.43 ... 0.51 inch	

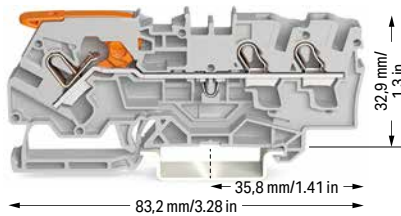
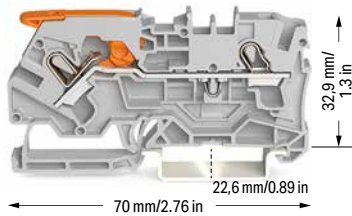





2-conductor through terminal block; with lever and Push-in CAGE CLAMP®		
Color	Item No.	Pack. Unit
gray ⑤	2104-1201 ④	50
blue ⑤	2104-1204 ③ ④	50

3-conductor through terminal block; with lever and Push-in CAGE CLAMP®		
Color	Item No.	Pack. Unit
gray ⑤	2104-1301 ④	50
blue ⑤	2104-1304 ③ ④	50

2-conductor ground terminal block; with lever and Push-in CAGE CLAMP®		
Color	Item No.	Pack. Unit
green-yellow ⑤	2104-1207 ④	50

3-conductor ground terminal block; with lever and Push-in CAGE CLAMP®		
Color	Item No.	Pack. Unit
green-yellow ⑤	2104-1307 ④	50

Item-Specific Accessories			
End and intermediate plate; 0.8 mm thick			
	orange	2104-1292	100 (25)
	gray	2104-1291	100 (25)

Item-Specific Accessories			
End and intermediate plate; 0.8 mm thick			
	orange	2104-1392	100 (25)
	gray	2104-1391	100 (25)

Accessories; 2104 Series
Appropriate marking systems: WMB/WMB Inline/Marking strips

Insulation stop; 5 pcs/strip; 0.25 ... 0.5 mm ²			
	light gray	2004-171	200 (25)

Star point jumper; insulated; I _N = I _N terminal block; light gray			
	1-3-5	2004-405/011-000	25

Insulation stop; 5 pcs/strip; 0.75 ... 1 mm ²			
	dark gray	2004-172	200 (25)

Delta jumper; insulated; I _N = I _N terminal block; light gray			
	1-2 3-4 5-6	2004-406/020-000	

Protective warning marker; with black high-voltage symbol; for 5 terminal blocks			
	yellow	2004-115	100 (25)

Modular connector; snaps together; for jumper contact slot			
	gray	2004-511	100 (25)

Push-in type jumper bar; insulated; I _N 32 A; light gray			
	2-way	2004-402	25
	3-way	2004-403	25
	4-way	2004-404	25
	5-way	2004-405	25
	6-way	2004-406	25
	7-way	2004-407	25
	8-way	2004-408	25
	9-way	2004-409	25
	10-way	2004-410	25

Spacer module; snaps together; bridges commoned terminal blocks			
	gray	2004-549	100 (25)

Push-in type jumper bar; insulated; I _N 32 A; light gray			
	1 to 3	2004-433	25
	1 to 4	2004-434	25
	1 to 5	2004-435	25
	1 to 6	2004-436	25
	1 to 7	2004-437	25
	1 to 8	2004-438	25
	1 to 9	2004-439	25
	1 to 10	2004-440	25

Testing tap; for max. 2.5 mm ²			
	gray	2009-182	100 (25)

① Conductor range: 0.5 ... 6 mm² "s+f-st"
Push-in termination: 1.5 ... 6 mm² "s" and 1.5 ... 4 mm² "insulated ferrules, 12 mm"
Depending on the conductor characteristic, a conductor with a smaller cross-section can also be inserted via push-in termination.

② 800 V = rated voltage
8 kV = rated impulse voltage
3 = pollution degree (see Section 15)

③ Terminal blocks with a blue insulated housing are suitable for Ex i applications.

④ Terminal blocks with an Ex mark are suitable for Ex e II applications.
550 V; 30 A (see Section 15)

Please observe the application notes:
Jumpers, from page 177
Testing accessories, from page 170
Marking accessories, from page 246

Approvals and corresponding ratings, visit www.wago.com

Accessories; 2104 Series
Appropriate marking systems:
WMB/WMB Inline/Marking strips

Marking strip; plain; 11 mm wide; 50 m reel			
	white	2009-110	1

WMB marker card; white; 10 strips with 10 markers/card; stretchable 5 ... 5.2 mm

	plain	793-5501	5
---	-------	----------	---

PUSH-IN CAGE CLAMP®

Through Terminal Block, Ground Conductor Terminal Block TOPJOB® S; with Lever and Push-in CAGE CLAMP® 6 (10) mm²; 2106 Series

1

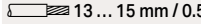
Technical Data	
0.5 ... 6 (10) mm ² ①	20 ... 8 AWG
800 V/8 kV/3 ②	600 V, 50 A ③
I _N 41 A (55 A)	600 V, 50 A ④
Terminal block width: 7.5 mm / 0.295 inch	
 13 ... 15 mm / 0.51 ... 0.59 inch	

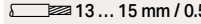
Technical Data	
0.5 ... 6 (10) mm ² ①	20 ... 8 AWG
800 V/8 kV/3 ②	600 V, 50 A ③
I _N 41 A (55 A)	600 V, 50 A ④
Terminal block width: 7.5 mm / 0.295 inch	
 13 ... 15 mm / 0.51 ... 0.59 inch	

- ① Conductor range: 0.5 ... 10 mm² "s+f-st"; Push-in termination: 2.5 ... 10 mm² "s" and 2.5 ... 6 mm² "insulated ferrules; 12 mm"
Depending on the conductor characteristic, a conductor with a smaller cross section can also be inserted via push-in termination.
- ② 800 V = rated voltage
8 kV = rated impulse voltage
3 = pollution degree (see Section 15)
- ③ Terminal blocks with a blue insulated housing are suitable for Ex i applications.
- ④ Terminal blocks with an Ex mark are suitable for Ex e II applications.
550 V; 41 A
33 A jumper (see Section 15)

Please observe the application notes:
Jumpers, from page 177
Testing accessories, from page 170
Marking, from page 640

Approvals and corresponding ratings, visit www.wago.com

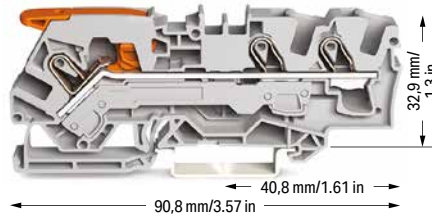

2-conductor through terminal block; with lever and Push-in CAGE CLAMP®

Color	Item No.	Pack. Unit
gray ⑤	2106-1201 ④	25
blue ⑤	2106-1204 ③ ④	25

3-conductor through terminal block; with lever and Push-in CAGE CLAMP®

Color	Item No.	Pack. Unit
gray ⑤	2106-1301 ④	25
blue ⑤	2106-1304 ③ ④	25



2-conductor ground terminal block; with lever and Push-in CAGE CLAMP®

green-yellow ⑤	2106-1207 ④	25
----------------	-------------	----



3-conductor ground terminal block; with lever and Push-in CAGE CLAMP®

green-yellow ⑤	2106-1307 ④	25
----------------	-------------	----

Accessories; item-specific

End and intermediate plate; 1 mm thick			
	orange	2106-1292	100 (25)
	gray	2106-1291	100 (25)

Accessories; item-specific

End and intermediate plate; 1 mm thick			
	orange	2106-1392	100 (25)
	gray	2106-1391	100 (25)

Accessories; 2106 Series

Appropriate marking systems: WMB/WMB Inline/Marking strips

Push-in type jumper bar; insulated; I_N 41 A; light gray

	2-way	2006-402	25
	3-way	2006-403	25
	4-way	2006-404	25
	5-way	2006-405	25

Test plug adapter; for 4 mm Ø test plug

	gray	2009-174	100 (25)
---	------	----------	----------

Push-in type jumper bar; insulated; I_N 41 A; light gray

	1 to 3	2006-433	25
	1 to 4	2006-434	25
	1 to 5	2006-435	25

Testing tap; for max. 2.5 mm²

	gray	2009-182	100 (25)
---	------	----------	----------

Star point jumper; insulated; I_N = I_N terminal block; light gray

	1-3-5	2006-405/011-000	25
---	-------	------------------	----

Marking strip; plain; 11 mm wide; 50 m reel

	white	2009-110	1
---	-------	----------	---

Protective warning marker; with black high-voltage symbol; for 5 terminal blocks

	yellow	2006-115	100 (25)
---	--------	----------	----------

WMB marking card; white; 10 strips with 10 markers/card; 5 ... 5.2 mm stretchable

	plain	793-5501	5
---	-------	----------	---

Lockout cap; for conductor entry and operating slot

	gray	2006-191	25
---	------	----------	----

Modular connector; snaps together; for jumper contact slot

	gray	2006-511	50 (25)
---	------	----------	---------

Spacer module; snaps together; bridges commoned terminal blocks

	gray	2006-549	50 (25)
---	------	----------	---------

Through Terminal Block, Ground Conductor Terminal Block TOPJOB® S; with Lever and Push-in CAGE CLAMP®

10 (16) mm²; 2110 Series

Technical Data

0.5 ... 10 (16) mm ² ①	20 ... 6 AWG
800 V/8 kV/3 ②	600 V, 65 A ③
I _N 57 A	600 V, 65 A ④
Terminal block width: 10 mm / 0.394 inch	
17 ... 19 mm / 0.67 ... 0.75 inch	

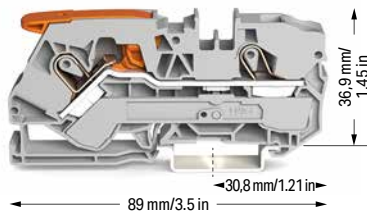

2-conductor through terminal block; with lever and Push-in CAGE CLAMP®

Color	Item No.	Pack. Unit
gray ⑤	2110-1201 ④	25
blue ⑤	2110-1204 ③ ④	25

2-conductor ground terminal block; with lever and Push-in CAGE CLAMP®

green-yellow ⑤	2110-1207 ④	25
----------------	-------------	----

Item-Specific Accessories

End and intermediate plate; 1 mm thick

orange	2110-1292	100 (25)
gray	2110-1291	100 (25)

Technical Data

0.5 ... 10 (16) mm ² ①	20 ... 6 AWG
800 V/8 kV/3 ②	600 V, 65 A ③
I _N 57 A	600 V, 65 A ④
Terminal block width: 10 mm / 0.394 inch	
17 ... 19 mm / 0.67 ... 0.75 inch	

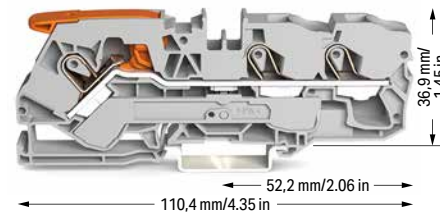

3-conductor through terminal block; with lever and Push-in CAGE CLAMP®

Color	Item No.	Pack. Unit
gray ⑤	2110-1301 ④	25
blue ⑤	2110-1304 ③ ④	25

3-conductor ground terminal block; with lever and Push-in CAGE CLAMP®

green-yellow ⑤	2110-1307 ④	25
----------------	-------------	----

Item-Specific Accessories

End and intermediate plate; 1 mm thick

orange	2110-1392	100 (25)
gray	2110-1391	100 (25)

Accessories; 2110 Series

Appropriate marking systems: WMB/WMB Inline/Marking strips

Push-in type jumper bar; insulated; I_N 57 A; light gray

2-way	2010-402	25
3-way	2010-403	25
4-way	2010-404	25
5-way	2010-405	25

Push-in type jumper bar; insulated; I_N 57 A; light gray

1 to 3	2010-433	25
1 to 4	2010-434	25
1 to 5	2010-435	25

Star point jumper; insulated; I_N = I_N terminal block; light gray

1-3-5	2010-405/011-000	25
-------	------------------	----

Protective warning marker; with black high-voltage symbol; for 5 terminal blocks

yellow	2010-115	100 (25)
--------	----------	----------

Finger guard; touch-proof cover protects unused conductor entries

yellow	2010-100	100 (25)
--------	----------	----------

Modular connector; snaps together; for jumper contact slot

gray	2010-511	50 (25)
------	----------	---------

Spacer module; snaps together; bridges commoned terminal blocks

gray	2010-549	50 (25)
------	----------	---------

Test plug adapter; for 4 mm Ø test plug

gray	2009-174	100 (25)
------	----------	----------

Testing tap; for max. 2.5 mm²

gray	2009-182	100 (25)
------	----------	----------

Marking strip; plain; 11 mm wide; 50 m reel

white	2009-110	1
-------	----------	---

WMB marking card; white; 10 strips with 10 markers/card; 5 ... 5.2 mm stretchable

plain	793-5501	5
-------	----------	---

① Conductor range: 0.5 ... 16 mm² "s+f-st"
Push-in termination: 4 ... 16 mm² "s" and 4 ... 10 mm² "insulated ferrules, 18 mm"
Depending on the conductor characteristic, a conductor with a smaller cross section can also be inserted via push-in termination.

② 800 V = rated voltage
8 kV = rated impulse voltage
3 = pollution degree (see Section 15)

③ Terminal blocks with a blue insulated housing are suitable for Ex i applications.

④ Terminal blocks with an Ex mark are suitable for Ex e II applications.
550 V; 57 A
50 A jumper (see Section 15)

Please observe the application notes:
Jumpers, from page 177
Testing accessories, from page 170
Marking, from page 640

Approvals and corresponding ratings, visit www.wago.com

PUSH-IN CAGE CLAMP®

Through Terminal Block, Ground Conductor Terminal Block TOPJOB® S; with Lever and Push-in CAGE CLAMP®

16 (25 "f-st") mm²; 2116 Series

1

Technical Data

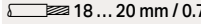
0.5 ... 16 (25 "f-st") mm ² ❶	20 ... 4 AWG
800 V/8 kV/3 ❷	600 V, 85 A ❸
I _N 76 A (90 A)	600 V, 78 A ❹
Terminal block width: 12 mm / 0.472 inch	
 18 ... 20 mm / 0.71 ... 0.79 inch	

Technical Data

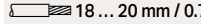
0.5 ... 16 (25 "f-st") mm ² ❶	20 ... 4 AWG
800 V/8 kV/3 ❷	600 V, 85 A ❸
I _N 76 A (90 A)	600 V, 78 A ❹
Terminal block width: 12 mm / 0.472 inch	
 18 ... 20 mm / 0.71 ... 0.79 inch	

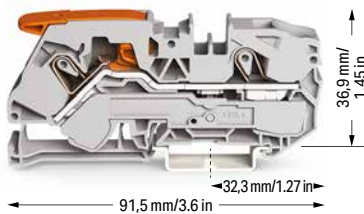

2-conductor through terminal block; with lever and Push-in CAGE CLAMP®

Color	Item No.	Pack. Unit
gray ❺	2116-1201	20
blue ❻	2116-1204 ❸	20

3-conductor through terminal block; with lever and Push-in CAGE CLAMP®

Color	Item No.	Pack. Unit
gray ❺	2116-1301	20
blue ❻	2116-1304 ❸	20

2-conductor ground terminal block; with lever and Push-in CAGE CLAMP®

15 mm high DIN-35 rails shall be used for a current load higher than 76 A!

Color	Item No.	Pack. Unit
green-yellow ❻	2116-1207	20

3-conductor ground terminal block; with lever and Push-in CAGE CLAMP®

15 mm high DIN-35 rails shall be used for a current load higher than 76 A!

Color	Item No.	Pack. Unit
green-yellow ❻	2116-1307	20

Accessories; item-specific

End and intermediate plate; 1 mm thick

orange	2116-1292	100 (25)
gray	2116-1291	100 (25)

Accessories; item-specific

End and intermediate plate; 1 mm thick

orange	2116-1392	100 (25)
gray	2116-1391	100 (25)

Accessories; 2116 Series

Appropriate marking systems: WMB/WMB Inline/Marking strips

Push-in type jumper bar; insulated; I_N 76 A; light gray

 2-way	2016-402	25
 3-way	2016-403	25
 4-way	2016-404	25
 5-way	2016-405	25

Modular connector; snaps together; for jumper contact slot

 gray	2016-511	50 (25)
--	----------	---------

Push-in type jumper bar; insulated; I_N 76 A; light gray

 1 to 3	2016-433	25
 1 to 4	2016-434	25
 1 to 5	2016-435	25

Spacer module; snaps together; bridges commoned terminal blocks

 gray	2016-549	50 (25)
--	----------	---------

Star point jumper; insulated; I_N = I_N terminal block; light gray

 1-3-5	2016-405/011-000	25
---	------------------	----

Test plug adapter; for 4 mm Ø test plug

 gray	2009-174	100 (25)
--	----------	----------

Protective warning marker; with black high-voltage symbol; for 5 terminal blocks

 yellow	2016-115	100 (25)
--	----------	----------

Testing tap; for max. 2.5 mm²

 gray	2009-182	100 (25)
--	----------	----------

Three-phase set; with orange end plate; with a lever and Push-in CAGE CLAMP®
15 mm high DIN-35 rails shall be used for a current load higher than 76 A!

	2116-1201/605-038	1
---	-------------------	---

Marking strip; plain; 11 mm wide; 50 m reel

 white	2009-110	1
---	----------	---

Finger guard; touch-proof cover protects unused conductor entries

 yellow	2016-100	100 (25)
--	----------	----------

WMB marking card; white; 10 strips with 10 markers/card; 5 ... 5.2 mm stretchable

 plain	793-5501	5
---	----------	---

❶ Conductor range: 0.5 ... 16 mm² "s+f-st", 25 mm² "f-st"; Push-in termination: 6 ... 16 mm² "s" and 6 ... 16 mm² "insulated ferrules; 18 mm"
Depending on the conductor characteristic, a conductor with a smaller cross section can also be inserted via push-in termination.

❷ 800 V = rated voltage
8 kV = rated impulse voltage
3 = pollution degree (see Section 15)

❸ Terminal blocks with a blue insulated housing are suitable for Ex i applications.

❹ Terminal blocks with an Ex mark are suitable for Ex e II applications.
550 V; 76 A
65 A jumper (see Section 15)

Please observe the application notes:
Jumpers, from page 177
Testing accessories, from page 171
Marking, from page 640

Approvals and corresponding ratings, visit www.wago.com

Through Terminal Block, Ground Conductor Terminal Block TOPJOB® S; with Lever and Push-Button

2.5 (4) mm²; 2102 Series

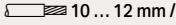
Technical Data	
0.25 ... 2.5 (4) mm ² ①	22 ... 12 AWG
800 V/8 kV/3 ②	600 V, 20 A ③
I _N 24 A (32 A)	600 V, 20 A ④
Terminal block width: 5.2 mm / 0.205 inch	
 10 ... 12 mm / 0.39 ... 0.47 inch	

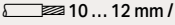
Technical Data	
0.25 ... 2.5 (4) mm ² ①	22 ... 12 AWG
800 V/8 kV/3 ②	600 V, 20 A ③
I _N 24 A (30 A)	600 V, 20 A ④
Terminal block width: 5.2 mm / 0.205 inch	
 10 ... 12 mm / 0.39 ... 0.47 inch	

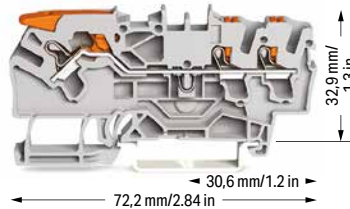
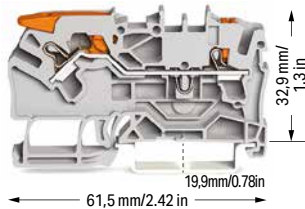





2-conductor through terminal block; with lever and push-button		
Color	Item No.	Pack. Unit
gray ⑤	2102-5201 ④	50
blue ⑤	2102-5204 ③ ④	50

3-conductor through terminal block; with lever and push-button		
Color	Item No.	Pack. Unit
gray ⑤	2102-5301 ④	50
blue ⑤	2102-5304 ③ ④	50

2-conductor ground terminal block; with lever and push-button		
Color	Item No.	Pack. Unit
green-yellow ⑤	2102-5207 ④	50

3-conductor ground terminal block; with lever and push-button		
Color	Item No.	Pack. Unit
green-yellow ⑤	2102-5307 ④	50

Accessories; item-specific			
End and intermediate plate; 0.8 mm thick			
	orange	2102-1292	100 (25)
	gray	2102-1291	100 (25)

Accessories; item-specific			
End and intermediate plate; 0.8 mm thick			
	orange	2102-1392	100 (25)
	gray	2102-1391	100 (25)

Accessories; 2102 Series
Appropriate marking systems: WMB/WMB Inline/Marking strips

Insulation stop; 5 pcs/strip; 0.25 ... 0.5 mm ²			
	light gray	2002-171	200 (25)

Star point jumper; insulated; I _N = I _N terminal block; light gray			
	1-3-5	2002-405/011-000	25

Insulation stop; 5 pcs/strip; 0.75 ... 1 mm ²			
	dark gray	2002-172	200 (25)

Adjacent jumper for continuous commoning; insulated; I _N 25 A, light gray			
	2-way	2002-400	25

Push-in type jumper bar; insulated; I _N 25 A; light gray			
	2-way	2002-402	25
	3-way	2002-403	25
	4-way	2002-404	25
	5-way	2002-405	25
	6-way	2002-406	25
	7-way	2002-407	25
	8-way	2002-408	25
	9-way	2002-409	25
	10-way	2002-410	25

Adjacent jumper for continuous commoning; insulated; I _N 25 A; 1 to 3			
	light gray	2002-423	25
	red	2002-423/000-005	25
	blue	2002-423/000-006	25

Push-in type jumper bar; insulated; I _N 25 A; light gray			
	1 to 3	2002-433	25
	1 to 4	2002-434	25
	1 to 5	2002-435	25
	1 to 6	2002-436	25
	1 to 7	2002-437	25
	1 to 8	2002-438	25
	1 to 9	2002-439	25
	1 to 10	2002-440	25

Staggered jumper; insulated; I _N 25 A; light gray			
	2-way	2002-472	25
	3-way	2002-473	25
	4-way	2002-474	25
	5-way	2002-475	25
	6-way	2002-476	25
	7-way	2002-477	25
	8-way	2002-478	25
	9-way	2002-479	25
	10-way	2002-480	25
	11-way	2002-481	25
	12-way	2002-482	25

Delta jumper; insulated; I _N = I _N terminal block; light gray			
	1-2 3-4 5-6	2002-406/020-000	25

① Conductor range: 0.25 ... 4 mm² "s+f-st"; Push-in termination: 1 ... 4 mm² "s" and 1 ... 2.5 mm² "insulated ferrules, 12 mm"
Depending on the conductor characteristic, a conductor with a smaller cross section can also be inserted via push-in termination.

② 800 V = rated voltage
8 kV = rated impulse voltage
3 = pollution degree (see Section 15)

③ Terminal blocks with a blue insulated housing are suitable for Ex i applications.

④ Terminal blocks with an Ex mark are suitable for Ex e II applications.
550 V; 23.5 A
20 A jumper (see Section 15)

Please observe the application notes:
Jumpers, from page 174
Testing accessories, from page 169
Marking, from page 640

Approvals and corresponding ratings, visit www.wago.com

Accessories; 2102 Series
Appropriate marking systems:
WMB/WMB Inline/Marking strips

Customized staggered jumper; insulated; with contact lugs broken off at the factory and circuit printing; I_N 25 A; light gray

	1-3	2002-473/011-000	25
	1-3-5	2002-475/011-000	25
	1-3-5-7	2002-477/011-000	25
	1-3-5-7-9	2002-479/011-000	25
	1-3-5-7-9-11	2002-481/011-000	25

Push-in type wire jumper; insulated; 1.5 mm² conductor cross-section; I_N 18 A

	L = 60 mm	2009-412	100 (10)
	L = 110 mm	2009-414	100 (10)
	L = 250 mm	2009-416	100 (10)

Modular connector; snaps together; for jumper contact slot

	gray	2002-511	100 (25)
---	------	----------	----------

Spacer module; snaps together; bridges commoned terminal blocks

	gray	2002-549	100 (25)
---	------	----------	----------

Test plug adapter; for 4 mm Ø test plug

	gray	2009-174	100 (25)
---	------	----------	----------

Testing tap; for max. 2.5 mm²

	gray	2009-182	100 (25)
---	------	----------	----------

Marking strip; plain; 11 mm wide; 50 m reel

	white	2009-110	1
---	-------	----------	---

WMB Inline, plain; 1,500 WMB markers (5 mm)/reel; 5 ... 5.2 mm stretchable

	white	2009-115	1
---	-------	----------	---

WMB marking card; white; 10 strips with 10 markers/card; 5 ... 5.2 mm stretchable

	plain	793-5501	5
---	-------	----------	---

Through and Ground Conductor Terminal Block TOPJOB® S; with Lever and Push-Button

4 (6) mm²; 2104 Series

1

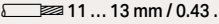
Technical Data	
0.5 ... 4 (6) mm ² ①	20 ... 10 AWG
800 V/8 kV/3 ②	600 V, 30 A ③
I _N 32 A (40 A)	600 V, 30 A ④
Terminal block width: 6.2 mm / 0.244 inch	
 11 ... 13 mm / 0.43 ... 0.51 inch	

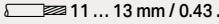
Technical Data	
0.5 ... 4 (6) mm ² ①	20 ... 10 AWG
800 V/8 kV/3 ②	600 V, 30 A ③
I _N 32 A (40 A)	600 V, 30 A ④
Terminal block width: 6.2 mm / 0.244 inch	
 11 ... 13 mm / 0.43 ... 0.51 inch	

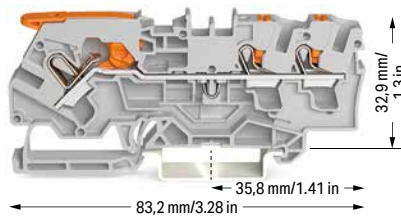
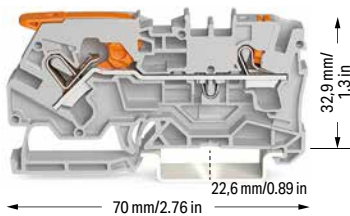





2-conductor through terminal block; with lever and push-button		
Color	Item No.	Pack. Unit
gray ⑤	2104-5201 ④	50
blue ⑤	2104-5204 ③ ④	50

3-conductor through terminal block; with lever and push-button		
Color	Item No.	Pack. Unit
gray ⑤	2104-5301 ④	50
blue ⑤	2104-5304 ③ ④	50

2-conductor ground terminal block; with lever and push-button		
Color	Item No.	Pack. Unit
green-yellow ⑤	2104-5207 ④	50

3-conductor ground terminal block; with lever and push-button		
Color	Item No.	Pack. Unit
green-yellow ⑤	2104-5307 ④	50

Item-Specific Accessories			
End and intermediate plate; 0.8 mm thick			
	orange	2104-1292	100 (25)
	gray	2104-1291	100 (25)

Item-Specific Accessories			
End and intermediate plate; 0.8 mm thick			
	orange	2104-1392	100 (25)
	gray	2104-1391	100 (25)

Accessories; 2104 Series
Appropriate marking systems: WMB/WMB Inline/Marking strips

Insulation stop; 5 pcs/strip; 0.25 ... 0.5 mm ²			
	light gray	2004-171	200 (25)

Star point jumper; insulated; I _N = I _N terminal block; light gray			
	1-3-5	2004-405/011-000	25

Insulation stop; 5 pcs/strip; 0.75 ... 1 mm ²			
	dark gray	2004-172	200 (25)

Delta jumper; insulated; I _N = I _N terminal block; light gray			
	1-2 3-4 5-6	2004-406/020-000	

Push-in type jumper bar; insulated; I _N 32 A; light gray			
	2-way	2004-402	25
	3-way	2004-403	25
	4-way	2004-404	25
	5-way	2004-405	25
	6-way	2004-406	25
	7-way	2004-407	25
	8-way	2004-408	25
	9-way	2004-409	25
	10-way	2004-410	25

Modular connector; snaps together; for jumper contact slot			
	gray	2004-511	100 (25)

Spacer module; snaps together; bridges commoned terminal blocks			
	gray	2004-549	100 (25)

Push-in type jumper bar; insulated; I _N 32 A; light gray			
	1 to 3	2004-433	25
	1 to 4	2004-434	25
	1 to 5	2004-435	25
	1 to 6	2004-436	25
	1 to 7	2004-437	25
	1 to 8	2004-438	25
	1 to 9	2004-439	25
	1 to 10	2004-440	25

Test plug adapter; for 4 mm Ø test plug			
	gray	2009-174	100 (25)

Testing tap; for max. 2.5 mm ²			
	gray	2009-182	100 (25)

- ① Conductor range: 0.5 ... 6 mm² "s+f-st"
Push-in termination: 1.5 ... 6 mm² "s" and 1.5 ... 4 mm² "insulated ferrules, 12 mm"
Depending on the conductor characteristic, a conductor with a smaller cross-section can also be inserted via push-in termination.
- ② 800 V = rated voltage
8 kV = rated impulse voltage
3 = pollution degree (see Section 15)
- ③ Terminal blocks with a blue insulated housing are suitable for Ex i applications.
- ④ Terminal blocks with an Ex mark are suitable for Ex e II applications.
550 V; 28 A (see Section 15)

Please observe the application notes:
Jumpers, from page 177
Testing accessories, from page 170
Marking accessories, from page 246

Approvals and corresponding ratings, visit www.wago.com

Accessories; 2104 Series
Appropriate marking systems:
WMB/WMB Inline/Marking strips

Marking strip; plain; 11 mm wide; 50 m reel			
	white	2009-110	1

WMB marker card; white; 10 strips with 10 markers/card; stretchable 5 ... 5.2 mm			
	plain	793-5501	5

Through Terminal Block, Ground Conductor Terminal Block TOPJOB® S; with Lever and Push-Button

6 (10) mm²; 2106 Series

Technical Data

0.5 ... 6 (10) mm ² ①	20 ... 8 AWG
800 V/8 kV/3 ②	600 V, 50 A ③
I _N 41 A (55 A)	600 V, 50 A ④
Terminal block width: 7.5 mm / 0.295 inch	
 13 ... 15 mm / 0.51 ... 0.59 inch	



2-conductor through terminal block; with lever and push-button

Color	Item No.	Pack. Unit
gray ⑤	2106-5201 ④	25
blue ⑤	2106-5204 ③ ④	25

2-conductor ground terminal block; with lever and push-button

green-yellow ⑤	2106-5207 ④	25
----------------	-------------	----

Accessories; item-specific

End and intermediate plate; 1 mm thick

orange	2106-1292	100 (25)
gray	2106-1291	100 (25)



Accessories; 2106 Series

Appropriate marking systems: WMB/WMB Inline/Marking strips

Push-in type jumper bar; insulated; I_N 41 A; light gray

 2-way	2006-402	25
 3-way	2006-403	25
 4-way	2006-404	25
 5-way	2006-405	25

Push-in type jumper bar; insulated; I_N 41 A; light gray

 1 to 3	2006-433	25
 1 to 4	2006-434	25
 1 to 5	2006-435	25

Star point jumper; insulated; I_N = I_N terminal block; light gray

 1-3-5	2006-405/011-000	25
---	------------------	----

Lockout cap; for conductor entry and operating slot

 gray	2006-191	25
--	----------	----

Modular connector; snaps together; for jumper contact slot

 gray	2006-511	50 (25)
--	----------	---------

Spacer module; snaps together; bridges commoned terminal blocks

 gray	2006-549	50 (25)
--	----------	---------

Technical Data

0.5 ... 6 (10) mm ² ①	20 ... 8 AWG
800 V/8 kV/3 ②	600 V, 50 A ③
I _N 41 A (55 A)	600 V, 50 A ④
Terminal block width: 7.5 mm / 0.295 inch	
 13 ... 15 mm / 0.51 ... 0.59 inch	

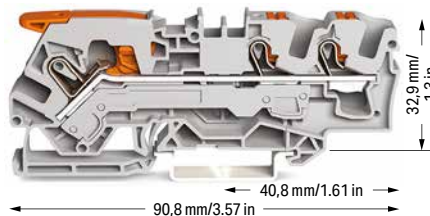

3-conductor through terminal block; with lever and push-button

Color	Item No.	Pack. Unit
gray ⑤	2106-5301 ④	25
blue ⑤	2106-5304 ③ ④	25

3-conductor ground terminal block; with lever and push-button

green-yellow ⑤	2106-5307 ④	25
----------------	-------------	----

Accessories; item-specific

End and intermediate plate; 1 mm thick

orange	2106-1392	100 (25)
gray	2106-1391	100 (25)

Test plug adapter; for 4 mm Ø test plug

 gray	2009-174	100 (25)
--	----------	----------

Testing tap; for max. 2.5 mm²

 gray	2009-182	100 (25)
--	----------	----------

Marking strip; plain; 11 mm wide; 50 m reel

 white	2009-110	1
---	----------	---

WMB marking card; white; 10 strips with 10 markers/card; 5 ... 5.2 mm stretchable

 plain	793-5501	5
---	----------	---

① Conductor range: 0.5 ... 10 mm² "s+f-st";
Push-in termination: 2.5 ... 10 mm² "s" and
2.5 ... 6 mm² "insulated ferrules; 12 mm"
Depending on the conductor characteristic, a conductor
with a smaller cross section can also be inserted
via push-in termination.

② 800 V = rated voltage
8 kV = rated impulse voltage
3 = pollution degree
(see Section 15)

③ Terminal blocks with a blue insulated housing are
suitable for Ex i applications.

④ Terminal blocks with an Ex mark are suitable for Ex e II
applications.
550 V; 41 A
33 A jumper
(see Section 15)

Please observe the application notes:
Jumpers, from page 177
Testing accessories, from page 170
Marking, from page 640

Approvals and corresponding ratings,
visit www.wago.com

PUSH-IN CAGE CLAMP®

Through Terminal Block, Ground Conductor Terminal Block TOPJOB® S; with Lever and Push-Button

10 (16) mm²; 2110 Series

1

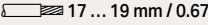
Technical Data	
0.5 ... 10 (16) mm ² ①	20 ... 6 AWG
800 V/8 kV/3 ②	600 V, 65 A ③
I _N 57 A	600 V, 65 A ④
Terminal block width: 10 mm / 0.394 inch	
 17 ... 19 mm / 0.67 ... 0.75 inch	

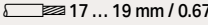
Technical Data	
0.5 ... 10 (16) mm ² ①	20 ... 6 AWG
800 V/8 kV/3 ②	600 V, 65 A ③
I _N 57 A	600 V, 65 A ④
Terminal block width: 10 mm / 0.394 inch	
 17 ... 19 mm / 0.67 ... 0.75 inch	

- ① Conductor range: 0.5 ... 16 mm² "s+f-st"
Push-in termination: 4 ... 16 mm² "s" and 4 ... 10 mm² "insulated ferrules, 18 mm"
Depending on the conductor characteristic, a conductor with a smaller cross section can also be inserted via push-in termination.
- ② 800 V = rated voltage
8 kV = rated impulse voltage
3 = pollution degree
(see Section 15)
- ③ Terminal blocks with a blue housing are suitable for Ex i applications.
- ④ Terminal blocks with an Ex mark are suitable for Ex e II applications.
550 V; 57 A
50 A jumper
(see Section 15)

Please observe the application notes:
Jumpers, from page 177
Testing accessories, from page 170
Marking, from page 640

Approvals and corresponding ratings, visit www.wago.com

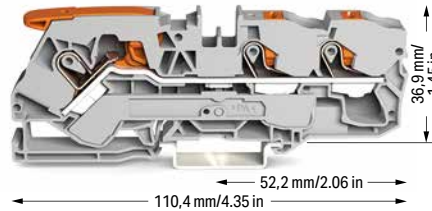
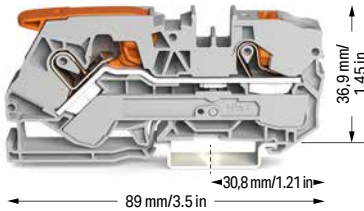





2-conductor through terminal block; with lever and push-button		
Color	Item No.	Pack. Unit
gray ⑤	2110-5201 ④	25
blue ⑤	2110-5204 ③ ④	25

3-conductor through terminal block; with lever and push-button		
Color	Item No.	Pack. Unit
gray ⑤	2110-5301 ④	25
blue ⑤	2110-5304 ③ ④	25



2-conductor ground terminal block; with lever and Push-in CAGE CLAMP®		
green-yellow ⑤	2110-5207 ④	25

3-conductor ground terminal block; with lever and Push-in CAGE CLAMP®		
green-yellow ⑤	2110-5307 ④	25



Item-Specific Accessories			
End and intermediate plate; 1 mm thick			
	orange	2110-1292	100 (25)
	gray	2110-1291	100 (25)

Item-Specific Accessories			
End and intermediate plate; 1 mm thick			
	orange	2110-1392	100 (25)
	gray	2110-1391	100 (25)

Accessories; 2110 Series
Appropriate marking systems: WMB/WMB Inline/Marking strips

Push-in type jumper bar; insulated; I _N 57 A; light gray			
	2-way	2010-402	25
	3-way	2010-403	25
	4-way	2010-404	25
	5-way	2010-405	25

Test plug adapter; for 4 mm Ø test plug			
	gray	2009-174	100 (25)

Push-in type jumper bar; insulated; I _N 57 A; light gray			
	1 to 3	2010-433	25
	1 to 4	2010-434	25
	1 to 5	2010-435	25

Testing tap; for max. 2.5 mm ²			
	gray	2009-182	100 (25)

Star point jumper; insulated; I _N = I _N terminal block; light gray			
	1-3-5	2010-405/011-000	25

Marking strip; plain; 11 mm wide; 50 m reel			
	white	2009-110	1

Finger guard; touch-proof cover protects unused conductor entries			
	yellow	2010-100	100 (25)

WMB marking card; white; 10 strips with 10 markers/card; 5 ... 5.2 mm stretchable			
	plain	793-5501	5

Modular connector; snaps together; for jumper contact slot			
	gray	2010-511	50 (25)

Spacer module; snaps together; bridges commoned terminal blocks			
	gray	2010-549	50 (25)

Through Terminal Block, Ground Conductor Terminal Block TOPJOB® S; with Lever and Push-Button

16 (25 "f-st") mm²; 2116 Series

Technical Data

0.5 ... 16 (25 "f-st") mm ² ①	20 ... 4 AWG
800 V/8 kV/3 ②	600 V, 85 A ③
I _N 76 A (90 A)	600 V, 78 A ④
Terminal block width: 12 mm / 0.472 inch	
 18 ... 20 mm / 0.71 ... 0.79 inch	

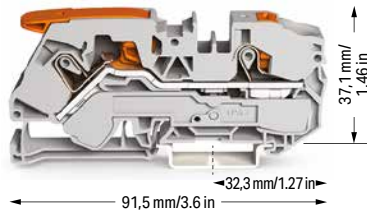

2-conductor through terminal block; with lever and push-button

Color	Item No.	Pack. Unit
gray ⑤	2116-5201 ④	20
blue ⑤	2116-5204 ③ ④	20

2-conductor ground terminal block; with lever and push-button

15 mm high DIN-35 rails shall be used for a current load higher than 76 A!

green-yellow ⑤	2116-5207 ④	20
----------------	-------------	----

Accessories; item-specific

End and intermediate plate; 1 mm thick

	orange	2116-1292	100 (25)
	gray	2116-1291	100 (25)

Accessories; 2116 Series

Appropriate marking systems: WMB/WMB Inline/Marking strips

Push-in type jumper bar; insulated; I_N 76 A; light gray

	2-way	2016-402	25
	3-way	2016-403	25
	4-way	2016-404	25
	5-way	2016-405	25

Push-in type jumper bar; insulated; I_N 76 A; light gray

	1 to 3	2016-433	25
	1 to 4	2016-434	25
	1 to 5	2016-435	25

Star point jumper; insulated; I_N = I_N terminal block; light gray

	1-3-5	2016-405/011-000	25
---	-------	------------------	----

Finger guard; touch-proof cover protects unused conductor entries

	yellow	2016-100	100 (25)
---	--------	----------	----------

Modular connector; snaps together; for jumper contact slot

	gray	2016-511	50 (25)
---	------	----------	---------

Spacer module; snaps together; bridges commoned terminal blocks

	gray	2016-549	50 (25)
---	------	----------	---------

Technical Data

0.5 ... 16 (25 "f-st") mm ² ①	20 ... 4 AWG
800 V/8 kV/3 ②	600 V, 85 A ③
I _N 76 A (90 A)	600 V, 78 A ④
Terminal block width: 12 mm / 0.472 inch	
 18 ... 20 mm / 0.71 ... 0.79 inch	



3-conductor through terminal block; with lever and push-button

Color	Item No.	Pack. Unit
gray ⑤	2116-5301 ④	20
blue ⑤	2116-5304 ③ ④	20

3-conductor ground terminal block; with lever and push-button

15 mm high DIN-35 rails shall be used for a current load higher than 76 A!

green-yellow ⑤	2116-5307 ④	20
----------------	-------------	----

Accessories; item-specific

End and intermediate plate; 1 mm thick

	orange	2116-1392	100 (25)
	gray	2116-1391	100 (25)

Test plug adapter; for 4 mm Ø test plug

	gray	2009-174	100 (25)
---	------	----------	----------

Testing tap; for max. 2.5 mm²

	gray	2009-182	100 (25)
---	------	----------	----------

Marking strip; plain; 11 mm wide; 50 m reel

	white	2009-110	1
---	-------	----------	---

WMB marking card; white; 10 strips with 10 markers/card; 5 ... 5.2 mm stretchable

	plain	793-5501	5
---	-------	----------	---

① Conductor range: 0.5 ... 16 mm² "s+f-st", 25 mm² "f-st"; Push-in termination: 6 ... 16 mm² "s" and 6 ... 16 mm² "insulated ferrules; 18 mm"
Depending on the conductor characteristic, a conductor with a smaller cross section can also be inserted via push-in termination.

② 800 V = rated voltage
8 kV = rated impulse voltage
3 = pollution degree (see Section 15)

③ Terminal blocks with a blue insulated housing are suitable for Ex i applications.

④ Terminal blocks with an Ex mark are suitable for Ex e II applications.
550 V; 76 A
65 A jumper (see Section 15)

Please observe the application notes:
Jumpers, from page 177
Testing accessories, from page 171
Marking, from page 640

Approvals and corresponding ratings, visit www.wago.com

Through Terminal Block, Ground Conductor Terminal Block TOPJOB® S; with Push-Button 1 (1.5) mm²; 2200 Series



1



Technical Data	
0.14 ... 1 (1.5) mm ² ①	24 ... 16 AWG
800 V/8 kV/3 ②	600 V, 10 A ③
I _N 13.5 A (17.5 A)	600 V, 10 A ④
Terminal block width: 3.5 mm / 0.138 inch	
 9 ... 11 mm / 0.35 ... 0.43 inch	

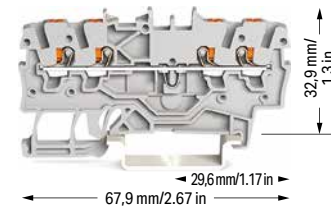
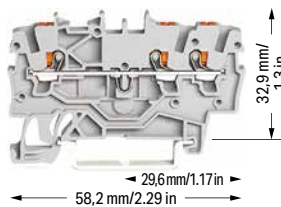
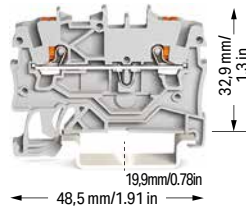

Technical Data	
0.14 ... 1 (1.5) mm ² ①	24 ... 16 AWG
800 V/8 kV/3 ②	600 V, 10 A ③
I _N 13.5 A (17.5 A)	600 V, 10 A ④
Terminal block width: 3.5 mm / 0.138 inch	
 9 ... 11 mm / 0.35 ... 0.43 inch	

Technical Data	
0.14 ... 1 (1.5) mm ² ①	24 ... 16 AWG
800 V/8 kV/3 ②	600 V, 10 A ③
I _N 13.5 A (17.5 A)	600 V, 10 A ④
Terminal block width: 3.5 mm / 0.138 inch	
 9 ... 11 mm / 0.35 ... 0.43 inch	





2-conductor through terminal block; with push-button		
Color	Item No.	Pack. Unit
 gray ⑤	2200-1201 ④	100
 blue ⑤	2200-1204 ③ ④	100



3-conductor through terminal block; with push-button		
Color	Item No.	Pack. Unit
 gray ⑤	2200-1301 ④	100
 blue ⑤	2200-1304 ③ ④	100



4-conductor through terminal block; with push-button		
Color	Item No.	Pack. Unit
 gray ⑤	2200-1401 ④	100
 blue ⑤	2200-1404 ③ ④	100



2-conductor ground terminal block; with push-button		
Color	Item No.	Pack. Unit
 green-yellow ⑤	2200-1207 ④	100



3-conductor ground terminal block; with push-button		
Color	Item No.	Pack. Unit
 green-yellow ⑤	2200-1307 ④	100

4-conductor ground terminal block; with push-button		
Color	Item No.	Pack. Unit
 green-yellow ⑤	2200-1407 ④	100

Accessories; item-specific			
End and intermediate plate; 0.7 mm thick			
	orange	2000-1292	100 (25)
	gray	2000-1291	100 (25)

Accessories; item-specific			
End and intermediate plate; 0.7 mm thick			
	orange	2000-1392	100 (25)
	gray	2000-1391	100 (25)

Accessories; item-specific			
End and intermediate plate; 0.7 mm thick			
	orange	2000-1492	100 (25)
	gray	2000-1491	100 (25)









Ex e/Ex i separator; orange; 3 mm thick			
	90 mm	209-190	50 (25)
	120 mm	209-191	50 (25)



Ex e/Ex i separator; orange; 3 mm thick			
	120 mm	209-191	50 (25)

Ex e/Ex i separator; orange; 3 mm thick			
	120 mm	209-191	50 (25)









Accessories; 2200 Series

Appropriate marking systems: WMB/WMB Inline/Marking strips

Push-in type jumper bar; insulated; I _N 14 A; light gray			
	2-way	2000-402	25
	3-way	2000-403	25
	4-way	2000-404	25
	5-way	2000-405	25
	6-way	2000-406	25
	7-way	2000-407	25
	8-way	2000-408	25
	9-way	2000-409	25
	10-way	2000-410	25

Push-in type wire jumper; insulated; 0.75 mm ² conductor cross-section; I _N 9 A			
	L = 60 mm	2009-402	100 (10)
	L = 110 mm	2009-404	100 (10)
	L = 250 mm	2009-406	100 (10)

Marking strip; plain; 11 mm wide; 50 m reel			
	white	2009-110	1

Push-in type jumper bar; insulated; I _N 14 A; light gray			
	1 to 3	2000-433	25
	1 to 4	2000-434	25
	1 to 5	2000-435	25
	1 to 6	2000-436	25
	1 to 7	2000-437	25
	1 to 8	2000-438	25
	1 to 9	2000-439	25
	1 to 10	2000-440	25

Modular connector; snaps together; for jumper contact slot			
Terminal block width: 5 mm / 0.197 inch			
	gray	2000-511	100 (25)

WMB Inline; plain; 2,300 WMB markers (3.5 mm)/reel			
	white	2009-113	1

Delta jumper; insulated; I _N = I _N terminal block; light gray			
	1-2 3-4 5-6	2000-406/020-000	25

Modular connector; snaps together; for jumper contact slot			
	gray	2000-510	100 (25)

WMB marking card; white; 10 strips with 10 markers/card; for 3.5 mm terminal block width			
	plain	793-3501	5

Star point jumper; insulated; I _N = I _N terminal block; light gray			
	1-3-5	2000-405/011-000	25

Spacer module; snaps together; bridges commoned terminal blocks			
	gray	2000-549	100 (25)

Test plug adapter; for 4 mm Ø test plug			
	gray	2009-174	100 (25)

Testing tap; for max. 2.5 mm ²			
	gray	2009-182	100 (25)

① Conductor range: 0.14 ... 1.5 mm² "s+f-st";
Push-in termination: 0.5 ... 1.5 mm² "s" and
0.5 ... 0.75 mm² "insulated ferrules; 10 mm"
Depending on the conductor characteristic, a conductor with a smaller cross section can also be inserted via push-in termination.

② 800 V = rated voltage
8 kV = rated impulse voltage
3 = pollution degree
(see Section 15)

③ Terminal blocks with a blue insulated housing are suitable for Ex i applications.

④ Terminal blocks with an Ex mark are suitable for Ex e II applications.
550 V; 13 A
12 A jumper
(see Section 15)

Please observe the application notes:
Jumpers, from page 174
Testing accessories, from page 168
Marking, from page 640

Approvals and corresponding ratings,
visit www.wago.com

Through Terminal Block, Ground Conductor Terminal Block, Double-Potential Terminal Block TOPJOB® S; with Push-Button

1.5 (2.5) mm²; 2201 Series

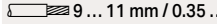
Technical Data	
0.25 ... 1.5 (2.5) mm ² ①	22 ... 14 AWG
800 V/8 kV/3 ②	600 V, 15 A ③
I _N 18 A (24 A)	600 V, 15 A ④
Terminal block width: 4.2 mm / 0.165 inch	
 9 ... 11 mm / 0.35 ... 0.43 inch	

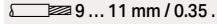
Technical Data	
0.25 ... 1.5 (2.5) mm ² ①	22 ... 14 AWG
800 V/8 kV/3 ②	600 V, 15 A ③
I _N 18 A (24 A)	600 V, 15 A ④
Terminal block width: 4.2 mm / 0.165 inch	
 9 ... 11 mm / 0.35 ... 0.43 inch	

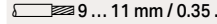
Technical Data	
0.25 ... 1.5 (2.5) mm ² ①	22 ... 14 AWG
800 V/8 kV/3 ②	600 V, 15 A ③
I _N 18 A (24 A)	600 V, 15 A ④
Terminal block width: 4.2 mm / 0.165 inch	
 9 ... 11 mm / 0.35 ... 0.43 inch	

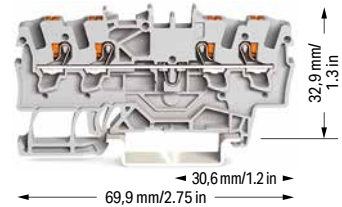
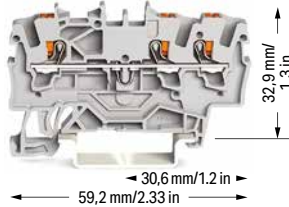
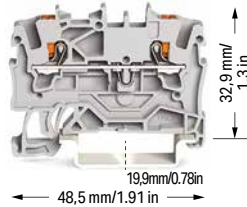

2-conductor through terminal block; with push-button		
Color	Item No.	Pack. Unit
gray ⑤	2201-1201 ④	100
blue ⑤	2201-1204 ③ ④	100



3-conductor through terminal block; with push-button		
Color	Item No.	Pack. Unit
gray ⑤	2201-1301 ④	100
blue ⑤	2201-1304 ③ ④	100
orange ⑤	2201-1302 ④	100



4-conductor through terminal block; with push-button		
Color	Item No.	Pack. Unit
gray ⑤	2201-1401 ④	100
blue ⑤	2201-1404 ③ ④	100



2-conductor ground terminal block; with push-button		
Color	Item No.	Pack. Unit
green-yellow ⑤	2201-1207 ④	100

3-conductor ground terminal block; with push-button		
Color	Item No.	Pack. Unit
green-yellow ⑤	2201-1307 ④	100

4-conductor ground terminal block; with push-button		
Color	Item No.	Pack. Unit
green-yellow ⑤	2201-1407 ④	100

Accessories; item-specific			
End and intermediate plate; 0.8 mm thick			
	orange	2002-1292	100 (25)
	gray	2002-1291	100 (25)



Accessories; item-specific			
End and intermediate plate; 0.8 mm thick			
	orange	2002-1392	100 (25)
	gray	2002-1391	100 (25)

Accessories; item-specific			
End and intermediate plate; 0.8 mm thick			
	orange	2002-1492	100 (25)
	gray	2002-1491	100 (25)

Separator; oversized; 2 mm thick			
	orange	2002-1294	100 (25)
	gray	2002-1293	100 (25)

Separator; oversized; 2 mm thick			
	orange	2002-1394	100 (25)
	gray	2002-1393	100 (25)

Separator; oversized; 2 mm thick			
	orange	2002-1494	100 (25)
	gray	2002-1493	100 (25)

Ex e/Ex i separator; orange; 3 mm thick			
	90 mm	209-190	50 (25)
	120 mm	209-191	50 (25)

Ex e/Ex i separator; orange; 3 mm thick			
	120 mm	209-191	50 (25)

Ex e/Ex i separator; orange; 3 mm thick			
	120 mm	209-191	50 (25)

Accessories; 2201 Series

Appropriate marking systems: WMB/WMB Inline/Marking strips

Insulation stop; 5 pcs/strip; 0.25 ... 0.5 mm ²			
	light gray	2001-171	200 (25)

Delta jumper; insulated; I _N = I _N terminal block; light gray			
	1-2 3-4 5-6	2001-406/020-000	25

Test plug adapter; for 4 mm Ø test plug			
	gray	2009-174	100 (25)

Push-in type jumper bar; insulated; I _N 18 A; light gray			
	2-way	2001-402	25
	3-way	2001-403	25
	4-way	2001-404	25
	5-way	2001-405	25
	6-way	2001-406	25
	7-way	2001-407	25
	8-way	2001-408	25
	9-way	2001-409	25
	10-way	2001-410	25

Star point jumper; insulated; I _N = I _N terminal block; light gray			
	1-3-5	2001-405/011-000	25

Testing tap; for max. 2.5 mm ²			
	gray	2009-182	100 (25)

Push-in type jumper bar; insulated; I _N 18 A; light gray			
	1 to 3	2001-433	25
	1 to 4	2001-434	25
	1 to 5	2001-435	25
	1 to 6	2001-436	25
	1 to 7	2001-437	25
	1 to 8	2001-438	25
	1 to 9	2001-439	25
	1 to 10	2001-440	25

Push-in type wire jumper; insulated; 1.5 mm ² conductor cross-section; I _N 18 A			
	L = 60 mm	2009-412	100 (10)
	L = 110 mm	2009-414	100 (10)
	L = 250 mm	2009-416	100 (10)

Marking strip; plain; 11 mm wide; 50 m reel			
	white	2009-110	1

Step-down jumper; insulated; commons 6/4 mm ² (10/12 AWG) to 4/2.5/1.5 mm ² (12/14/16 AWG); I _N 32 A			
	light gray	2006-499	25

WMB Inline; plain; 2,000 WMB markers (4 mm)/reel; 4 ... 4.2 mm stretchable			
	white	2009-114	1

Modular connector; snaps together; for jumper contact slot			
	gray	2001-511	100 (25)

WMB marking card; white; 10 strips with 10 markers/card; 4 ... 4.2 mm stretchable			
	plain	793-4501	5

① Conductor range: 0.25 ... 2.5 mm² "s+f-st";
Push-in termination: 0.75 ... 2.5 mm² "s" and
0.75 ... 1.5 mm² "insulated ferrules; 12 mm"
Depending on the conductor characteristic, a conduc-
tor with a smaller cross section can also be inserted
via push-in termination.

② 800 V = rated voltage
8 kV = rated impulse voltage
3 = pollution degree
(see Section 15)

③ Terminal blocks with a blue insulated housing are
suitable for Ex i applications.

④ Terminal blocks with an Ex mark are suitable for Ex e II
applications.
550 V; 17.5 A
(see Section 15)

Please observe the application notes:
Jumpers, from page 177
Testing accessories, from page 168
Marking, from page 640

Approvals and corresponding ratings,
visit www.wago.com





**Step-down jumper (2006-499) commons 6/4 mm²
(10/12 AWG) terminal blocks (2206/2204 Series) with
4/2.5/1.5 mm² (AWG 12/14/16) terminal blocks
(2204/2202/2201 Series).**

Through Terminal Block, Ground Conductor Terminal Block, Double-Potential Terminal Block TOPJOB® S; with Push-Button

2.5 (4) mm²; 2202 Series

1

Technical Data	
0.25 ... 2.5 (4) mm ² ①	22 ... 12 AWG
800 V/8 kV/3 ②	600 V, 20 A ③
I _N 24 A (32 A)	600 V, 20 A ④
Terminal block width: 5.2 mm / 0.205 inch	
 10 ... 12 mm / 0.39 ... 0.47 inch	

Technical Data	
0.25 ... 2.5 (4) mm ² ①	22 ... 12 AWG
800 V/8 kV/3 ②	600 V, 20 A ③
I _N 24 A (32 A)	600 V, 20 A ④
Terminal block width: 5.2 mm / 0.205 inch	
 10 ... 12 mm / 0.39 ... 0.47 inch	

Technical Data	
0.25 ... 2.5 (4) mm ² ①	22 ... 12 AWG
800 V/8 kV/3 ②	600 V, 20 A ③
I _N 24 A (32 A)	600 V, 20 A ④
Terminal block width: 5.2 mm / 0.205 inch	
 10 ... 12 mm / 0.39 ... 0.47 inch	

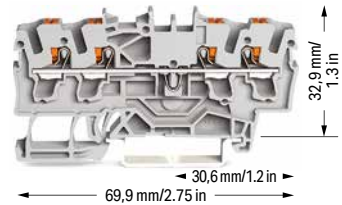
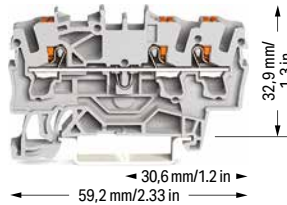
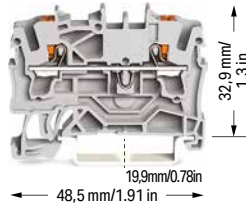

2-conductor through terminal block; with push-button		
Color	Item No.	Pack. Unit
gray ⑤	2202-1201 ④	100
blue ⑤	2202-1204 ③ ④	100
red ⑤	2202-1203 ④	100
black ⑤	2202-1205 ④	100
light gray ⑤	2202-1209 ④	100

3-conductor through terminal block; with push-button		
Color	Item No.	Pack. Unit
gray ⑤	2202-1301 ④	100
blue ⑤	2202-1304 ③ ④	100
orange ⑤	2202-1302 ④	100
red ⑤	2202-1303 ④	100
black ⑤	2202-1305 ④	100
light gray ⑤	2202-1309 ④	100

4-conductor through terminal block; with push-button		
Color	Item No.	Pack. Unit
gray ⑤	2202-1401 ④	100
blue ⑤	2202-1404 ③ ④	100
red ⑤	2202-1403 ④	100
black ⑤	2202-1405 ④	100
light gray ⑤	2202-1409 ④	100

2-conductor ground terminal block; with push-button		
green-yellow ⑤	2202-1207 ④	100

3-conductor ground terminal block; with push-button		
green-yellow ⑤	2202-1307 ④	100

4-conductor ground terminal block; with push-button		
green-yellow ⑤	2202-1407 ④	100

Accessories; item-specific

End and intermediate plate; 0.8 mm thick

	orange	2002-1292	100 (25)
	gray	2002-1291	100 (25)

Accessories; item-specific

End and intermediate plate; 0.8 mm thick

	orange	2002-1392	100 (25)
	gray	2002-1391	100 (25)

Accessories; item-specific

End and intermediate plate; 0.8 mm thick

	orange	2002-1492	100 (25)
	gray	2002-1491	100 (25)

Separator; oversized; 2 mm thick

	orange	2002-1294	100 (25)
	gray	2002-1293	100 (25)

Separator; oversized; 2 mm thick

	orange	2002-1394	100 (25)
	gray	2002-1393	100 (25)

Separator; oversized; 2 mm thick

	orange	2002-1494	100 (25)
	gray	2002-1493	100 (25)

Ex e/Ex i separator; orange; 3 mm thick

	90 mm	209-190	50 (25)
	120 mm	209-191	50 (25)

Ex e/Ex i separator; orange; 3 mm thick

	120 mm	209-191	50 (25)
---	--------	---------	---------

Ex e/Ex i separator; orange; 3 mm thick

	120 mm	209-191	50 (25)
---	--------	---------	---------

Accessories; 2202 Series

Appropriate marking systems: WMB/WMB Inline/Marking strips



Insulation stop; 5 pcs/strip; 0.25 ... 0.5 mm²

	light gray	2002-171	200 (25)
---	------------	----------	----------





Insulation stop; 5 pcs/strip; 0.75 ... 1 mm²

	dark gray	2002-172	200 (25)
---	-----------	----------	----------

Push-in type jumper bar; insulated; I_N 25 A; light gray

	2-way	2002-402	25
	3-way	2002-403	25
	4-way	2002-404	25
	5-way	2002-405	25
	6-way	2002-406	25
	7-way	2002-407	25
	8-way	2002-408	25
	9-way	2002-409	25
	10-way	2002-410	25

Push-in type jumper bar; insulated; I_N 25 A; light gray

	1 to 3	2002-433	25
	1 to 4	2002-434	25
	1 to 5	2002-435	25
	1 to 6	2002-436	25
	1 to 7	2002-437	25
	1 to 8	2002-438	25
	1 to 9	2002-439	25
	1 to 10	2002-440	25

Star point jumper; insulated; I_N = I_N terminal block; light gray

	1-3-5	2002-405/011-000	25
---	-------	------------------	----

Adjacent jumper for continuous commoning; insulated; I_N 25 A, light gray

	2-way	2002-400	25
---	-------	----------	----











Adjacent jumper for continuous commoning; insulated; I_N 25 A; 1 to 3

	light gray	2002-423	25
	red	2002-423/000-005	25
	blue	2002-423/000-006	25

Step-down jumper; insulated; commons 6/4 mm² (10/12 AWG) to 4/2.5/1.5 mm² (12/14/16 AWG); I_N 32 A

	light gray	2006-499	25
---	------------	----------	----

Staggered jumper; insulated; I_N 25 A; light gray

	2-way	2002-472	25
	3-way	2002-473	25
	4-way	2002-474	25
	5-way	2002-475	25
	6-way	2002-476	25
	7-way	2002-477	25
	8-way	2002-478	25
	9-way	2002-479	25
	10-way	2002-480	25
	11-way	2002-481	25
	12-way	2002-482	25

① Conductor range: 0.25 ... 4 mm² "s+f-st";
Push-in termination: 1 ... 4 mm² "s" and 1 ... 2.5 mm²
"insulated ferrules, 12 mm"
Depending on the conductor characteristic, a conductor with a smaller cross section can also be inserted via push-in termination.

② 800 V = rated voltage
8 kV = rated impulse voltage
3 = pollution degree
(see Section 15)

③ Terminal blocks with a blue insulated housing are suitable for Ex i applications.

④ Terminal blocks with an Ex mark are suitable for Ex e II applications.
550 V; 22 A
20 A jumper
(see Section 15)

Please observe the application notes:
Jumpers, from page 174
Testing accessories, from page 169
Marking, from page 640

Approvals and corresponding ratings,
visit www.wago.com

Accessories; 2202 Series

Appropriate marking systems:
WMB/WMB Inline/Marking strips

Customized staggered jumper; insulated; with contact lugs broken off at the factory and circuit printing; I_N 25 A; light gray

	1-3	2002-473/011-000	25
	1-3-5	2002-475/011-000	25
	1-3-5-7	2002-477/011-000	25
	1-3-5-7-9	2002-479/011-000	25
	1-3-5-7-9-11	2002-481/011-000	25

Push-in type wire jumper; insulated; 1.5 mm² conductor cross-section; I_N 18 A

	L = 60 mm	2009-412	100 (10)
	L = 110 mm	2009-414	100 (10)
	L = 250 mm	2009-416	100 (10)

Modular connector; snaps together; for jumper contact slot

	gray	2002-511	100 (25)
---	------	----------	----------

L-type test plug module; snaps together

	gray	2002-611	100 (25)
---	------	----------	----------

Test plug adapter; for 4 mm Ø test plug

	gray	2009-174	100 (25)
---	------	----------	----------

Testing tap; for max. 2.5 mm²

	gray	2009-182	100 (25)
---	------	----------	----------

Marking strip; plain; 11 mm wide; 50 m reel

	white	2009-110	1
---	-------	----------	---

WMB Inline, plain; 1,500 WMB markers (5 mm)/reel;
5 ... 5.2 mm stretchable

	white	2009-115	1
---	-------	----------	---

WMB marking card; white; 10 strips with 10 markers/card;
5 ... 5.2 mm stretchable

	plain	793-5501	5
---	-------	----------	---



Step-down jumper (2006-499) commons 6/4 mm² (10/12 AWG) terminal blocks (2206/2204 Series) with 4/2.5/1.5 mm² (AWG 12/14/16) terminal blocks (2204/2202/2201 Series).

Through Terminal Block, Ground Conductor Terminal Block, TOPJOB® S; with Push-Button 2.5 (4) mm²; 2202 Series

1

Technical Data

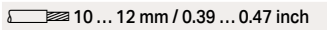
0.25 ... 2.5 (4) mm ² ①	22 ... 12 AWG
800 V/8 kV/3 ②	600 V, 20 A ③
I _N 24 A (32 A)	600 V, 20 A ④
Terminal block width: 5.2 mm / 0.205 inch	
 10 ... 12 mm / 0.39 ... 0.47 inch	



3-conductor through terminal block; with push-button

Color	Item No.	Pack. Unit
gray	2202-6301	100
blue	2202-6304 ⑤	100
orange	2202-6302	100
red	2202-6303	100
black	2202-6305	100
yellow	2202-6306	100

3-conductor ground terminal block; with push-button

green-yellow	2202-6307	100
--------------	-----------	-----

Accessories; 2202 Series

Appropriate marking systems:
WMB/WMB Inline/Marking strips

End and intermediate plate; 0.8 mm thick

orange	2002-6392	100 (25)
gray	2002-6391	100 (25)

Insulation stop; 5 pcs/strip; 0.25 ... 0.5 mm²

light gray	2002-171	200 (25)
------------	----------	----------

Insulation stop; 5 pcs/strip; 0.75 ... 1 mm²

dark gray	2002-172	200 (25)
-----------	----------	----------

Push-in type jumper bar; insulated; I_N 25 A; light gray

2-way	2002-402	25
3-way	2002-403	25
4-way	2002-404	25
5-way	2002-405	25
6-way	2002-406	25
7-way	2002-407	25
8-way	2002-408	25
9-way	2002-409	25
10-way	2002-410	25

Delta jumper; insulated; I_N = I_N terminal block; light gray

1-2 3-4 5-6	2002-406/020-000	25
-------------	------------------	----

Star point jumper; insulated; I_N = I_N terminal block; light gray

1-3-5	2002-405/011-000	25
-------	------------------	----

① Conductor range: 0.25 ... 4 mm² "s+f-st";
Push-in termination: 1 ... 4 mm² "s" and 1 ... 2.5 mm² "insulated ferrules, 12 mm"
Depending on the conductor characteristic, a conductor with a smaller cross section can also be inserted via push-in termination.

② 800 V = rated voltage
8 kV = rated impulse voltage
3 = pollution degree (see Section 15)

③ Terminal blocks with a blue insulated housing are suitable for Ex i applications.

Please observe the application notes:
Jumpers, from page 174
Testing accessories, from page 169
Marking, from page 640

Approvals and corresponding ratings, visit www.wago.com

Accessories; 2202 Series

Appropriate marking systems:
WMB/WMB Inline/Marking strips

Adjacent jumper for continuous commoning; insulated; I_N 25 A, light gray

2-way	2002-400	25
-------	----------	----

Push-in type jumper bar; insulated; I_N 25 A; light gray

1 to 3	2002-433	25
1 to 4	2002-434	25
1 to 5	2002-435	25
1 to 6	2002-436	25
1 to 7	2002-437	25
1 to 8	2002-438	25
1 to 9	2002-439	25
1 to 10	2002-440	25

Staggered jumper; insulated; I_N 25 A; light gray

2-way	2002-472	25
3-way	2002-473	25
4-way	2002-474	25
5-way	2002-475	25
6-way	2002-476	25
7-way	2002-477	25
8-way	2002-478	25
9-way	2002-479	25
10-way	2002-480	25
11-way	2002-481	25
12-way	2002-482	25

Customized staggered jumper; insulated; with contact lugs broken off at the factory and circuit printing; I_N 25 A; light gray

1-3	2002-473/011-000	25
1-3-5	2002-475/011-000	25
1-3-5-7	2002-477/011-000	25
1-3-5-7-9	2002-479/011-000	25
1-3-5-7-9-11	2002-481/011-000	25

Adjacent jumper for continuous commoning; insulated; I_N 25 A; 1 to 3

light gray	2002-423	25
red	2002-423/000-005	25
blue	2002-423/000-006	25

Push-in type wire jumper; insulated; 1.5 mm² conductor cross-section; I_N 18 A

L = 60 mm	2009-412	100 (10)
L = 110 mm	2009-414	100 (10)
L = 250 mm	2009-416	100 (10)

Accessories; 2202 Series

Appropriate marking systems:
WMB/WMB Inline/Marking strips

Modular connector; snaps together; for jumper contact slot

gray	2002-511	100 (25)
------	----------	----------

Spacer module; snaps together; bridges commoned terminal blocks

gray	2002-549	100 (25)
------	----------	----------

L-type test plug module; snaps together

gray	2002-611	100 (25)
------	----------	----------

L-type spacer module; snaps together; bridges commoned terminal blocks

gray	2002-649	100 (25)
------	----------	----------

Test plug adapter; for 4 mm Ø test plug

gray	2009-174	100 (25)
------	----------	----------

Testing tap; for max. 2.5 mm²

gray	2009-182	100 (25)
------	----------	----------

Marking strip; plain; 11 mm wide; 50 m reel

white	2009-110	1
-------	----------	---

WMB Inline, plain; 1,500 WMB markers (5 mm)/reel; 5 ... 5.2 mm stretchable

white	2009-115	1
-------	----------	---

WMB marking card; white; 10 strips with 10 markers/card; 5 ... 5.2 mm stretchable

plain	793-5501	5
-------	----------	---

Through Terminal Block, Ground Conductor Terminal Block TOPJOB® S; with Push-Button 2.5 (4) mm²; 2202 Series

Technical Data

0.25 ... 2.5 (4) mm ² ①	22 ... 12 AWG
800 V/8 kV/3 ①	600 V, 20 A ②
I _N 24 A (32 A)	600 V, 20 A ③
Terminal block width: 5.2 mm / 0.205 inch	
10 ... 12 mm / 0.39 ... 0.47 inch	

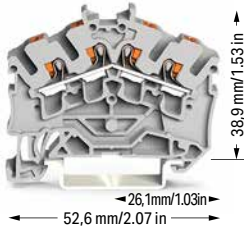

4-conductor through terminal block; with push-button
Notice: This terminal block cannot be commoned with push-in type jumper bars!

Color	Item No.	Pack. Unit
gray	2202-6401	100
blue	2202-6404 ③	100
orange	2202-6402	100
red	2202-6403	100
black	2202-6405	100
yellow	2202-6406	100

4-conductor ground terminal block; with push-button

green-yellow	2202-6407	100
--------------	-----------	-----

Accessories; 2202 Series

Appropriate marking systems:
WMB/WMB Inline/Marking strips

End and intermediate plate; 0.8 mm thick

orange	2002-6392	100 (25)
gray	2002-6391	100 (25)

Insulation stop; 5 pcs/strip; 0.25 ... 0.5 mm²

light gray	2002-171	200 (25)
------------	----------	----------

Insulation stop; 5 pcs/strip; 0.75 ... 1 mm²

dark gray	2002-172	200 (25)
-----------	----------	----------

Marking strip; plain; 11 mm wide; 50 m reel

white	2009-110	1
-------	----------	---

WMB Inline, plain; 1,500 WMB markers (5 mm)/reel;
5 ... 5.2 mm stretchable

white	2009-115	1
-------	----------	---

WMB marking card; white; 10 strips with 10 markers/card;
5 ... 5.2 mm stretchable

plain	793-5501	5
-------	----------	---

- Conductor range: 0.25 ... 4 mm² "s+f-st";
Push-in termination: 1 ... 4 mm² "s" and 1 ... 2.5 mm² "insulated ferrules, 12 mm"
Depending on the conductor characteristic, a conductor with a smaller cross section can also be inserted via push-in termination.
- 800 V = rated voltage
8 kV = rated impulse voltage
3 = pollution degree
(see Section 15)
- Terminal blocks with a blue insulated housing are suitable for Ex i applications.

Please observe the application notes:
Marking, from page 640

Approvals and corresponding ratings,
visit www.wago.com



3- and 4-conductor terminal blocks (angled type):
WAGO's Rail-Mount Terminal Blocks TOPJOB® S have a 35-degree conductor entry angle permitting a very small bend radius and an extremely short wiring distance to the cable duct. These are space- and cost-saving solutions for switchgear and control cabinet applications that use the LSC wiring system from Lütze. The design allows cable duct to be placed very close to the terminal blocks, keeping its height relatively low.

Product features:

- Push-in CAGE CLAMP® connection for all conductor types, with the additional benefit of solid, stranded and fine-stranded conductors with ferrules being simply pushed in
- Vibration-proof, fast, maintenance-free
- 3-conductor through and ground conductor terminal blocks equipped with a dual jumper slot
- 4-conductor terminal blocks permit potential multiplication – no additional jumpers or terminal blocks needed
- 3- and 4-conductor terminal blocks have the same dimensions.
- An end plate must be applied when changing from a 3-conductor terminal block to a 4-conductor terminal block and vice versa.

Through Terminal Block, Ground Conductor Terminal Block TOPJOB® S; with Push-Button 4 (6) mm²; 2204 Series

1

Technical Data	
0.5 ... 4 (6) mm ² ①	20 ... 10 AWG
800 V/8 kV/3 ②	600 V, 30 A ③
I _N 32 A (41 A)	600 V, 30 A ④
Terminal block width: 6.2 mm / 0.244 inch	
 11 ... 13 mm / 0.43 ... 0.51 inch	

Technical Data	
0.5 ... 4 (6) mm ² ①	20 ... 10 AWG
800 V/8 kV/3 ②	600 V, 30 A ③
I _N 32 A (41 A)	600 V, 30 A ④
Terminal block width: 6.2 mm / 0.244 inch	
 11 ... 13 mm / 0.43 ... 0.51 inch	

Technical Data	
0.5 ... 4 (6) mm ² ①	20 ... 10 AWG
800 V/8 kV/3 ②	600 V, 30 A ③
I _N 32 A (41 A)	600 V, 30 A ④
Terminal block width: 6.2 mm / 0.244 inch	
 11 ... 13 mm / 0.43 ... 0.51 inch	

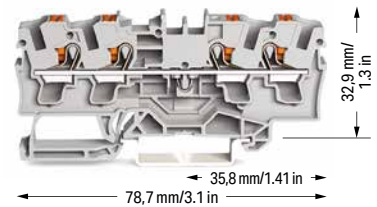
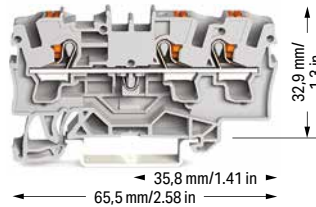
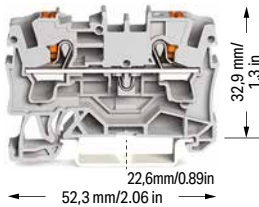

2-conductor through terminal block; with push-button		
Color	Item No.	Pack. Unit
gray ⑤	2204-1201 ④	50
blue ⑥	2204-1204 ③ ④	50



3-conductor through terminal block; with push-button		
Color	Item No.	Pack. Unit
gray ⑤	2204-1301 ④	50
blue ⑥	2204-1304 ③ ④	50



4-conductor through terminal block; with push-button		
Color	Item No.	Pack. Unit
gray ⑤	2204-1401 ④	50
blue ⑥	2204-1404 ③ ④	50



2-conductor ground terminal block; with push-button		
Color	Item No.	Pack. Unit
green-yellow ⑦	2204-1207 ④	50



3-conductor ground terminal block; with push-button		
Color	Item No.	Pack. Unit
green-yellow ⑦	2204-1307 ④	50



4-conductor ground terminal block; with push-button		
Color	Item No.	Pack. Unit
green-yellow ⑦	2204-1407 ④	50



Accessories; item-specific			
End and intermediate plate; 1 mm thick			
	orange	2004-1292	100 (25)
	gray	2004-1291	100 (25)



Accessories; item-specific			
End and intermediate plate; 1 mm thick			
	orange	2004-1392	100 (25)
	gray	2004-1391	100 (25)

Accessories; item-specific			
End and intermediate plate; 1 mm thick			
	orange	2004-1492	100 (25)
	gray	2004-1491	100 (25)

Separator; oversized; 2 mm thick			
	orange	2004-1294	100 (25)
	gray	2004-1293	100 (25)

Separator; oversized; 2 mm thick			
	orange	2004-1394	100 (25)
	gray	2004-1393	100 (25)

Separator; oversized; 2 mm thick			
	orange	2004-1494	100 (25)
	gray	2004-1493	100 (25)

Ex e/Ex i separator; orange; 3 mm thick			
	90 mm	209-190	50 (25)
	120 mm	209-191	50 (25)









Ex e/Ex i separator; orange; 3 mm thick			
	120 mm	209-191	50 (25)

Ex e/Ex i separator; orange; 3 mm thick			
	120 mm	209-191	50 (25)

Accessories; 2204 Series

Appropriate marking systems: WMB/WMB Inline/Marking strips









Insulation stop; 5 pcs/strip; 0.25 ... 0.5 mm ²			
	light gray	2004-171	200 (25)

Push-in type jumper bar; insulated; I _N 32 A; light gray			
	1 to 3	2004-433	25
	1 to 4	2004-434	25
	1 to 5	2004-435	25
	1 to 6	2004-436	25
	1 to 7	2004-437	25
	1 to 8	2004-438	25
	1 to 9	2004-439	25
	1 to 10	2004-440	25

Modular connector; snaps together; for jumper contact slot			
	gray	2004-511	100 (25)

Insulation stop; 5 pcs/strip; 0.75 ... 1 mm ²			
	dark gray	2004-172	200 (25)

Spacer module; snaps together; bridges commoned terminal blocks			
	gray	2004-549	100 (25)

Push-in type jumper bar; insulated; I _N 32 A; light gray			
	2-way	2004-402	25
	3-way	2004-403	25
	4-way	2004-404	25
	5-way	2004-405	25
	6-way	2004-406	25
	7-way	2004-407	25
	8-way	2004-408	25
	9-way	2004-409	25
	10-way	2004-410	25

Star point jumper; insulated; I _N = I _N terminal block; light gray			
	1-3-5	2004-405/011-000	25

Test plug adapter; for 4 mm Ø test plug			
	gray	2009-174	100 (25)

Delta jumper; insulated; I _N = I _N terminal block; light gray			
	1-2 3-4 5-6	2004-406/020-000	

Testing tap; for max. 2.5 mm ²			
	gray	2009-182	100 (25)

Step-down jumper; insulated; commons 6/4 mm ² (10/12 AWG) to 4/2.5/1.5 mm ² (12/14/16 AWG); I _N 32 A			
	light gray	2006-499	25

Marking strip; plain; 11 mm wide; 50 m reel			
	white	2009-110	1

WMB marking card; white; 10 strips with 10 markers/card; 5 ... 5.2 mm stretchable			
	plain	793-5501	5

① Conductor range: 0.5 ... 6 mm² "s+f-st";
 Push-in termination: 1.5 ... 6 mm² "s" and 1.5 ... 4 mm²
 "insulated ferrules; 12 mm"
 Depending on the conductor characteristic, a conductor with a smaller cross section can also be inserted via push-in termination.

② 800 V = rated voltage
 8 kV = rated impulse voltage
 3 = pollution degree
 (see Section 15)

③ Terminal blocks with a blue insulated housing are suitable for Ex i applications.

④ Terminal blocks with an Ex mark are suitable for Ex e II applications.
 550 V; 31 A
 30 A jumper
 (see Section 15)

Please observe the application notes:
 Jumpers, from page 177
 Testing accessories, from page 170
 Marking, from page 640

Approvals and corresponding ratings,
 visit www.wago.com



Step-down jumper (2006-499) commons 6/4 mm² (10/12 AWG) terminal blocks (2206/2204 Series) with 4/2.5/1.5 mm² (AWG 12/14/16) terminal blocks (2204/2202/2201 Series).

Through Terminal Block, Ground Conductor Terminal Block TOPJOB® S; with Push-Button 6 (10) mm²; 2206 Series

1

Technical Data

0.5 ... 6 (10) mm ² ①	20 ... 8 AWG
800 V/8 kV/3 ②	600 V, 50 A ③
I _N 41 A (57 A)	600 V, 50 A ④
Terminal block width: 7.5 mm / 0.295 inch	
 13 ... 15 mm / 0.51 ... 0.59 inch	

Technical Data

0.5 ... 6 (10) mm ² ①	20 ... 8 AWG
800 V/8 kV/3 ②	600 V, 50 A ③
I _N 41 A (57 A)	600 V, 50 A ④
Terminal block width: 7.5 mm / 0.295 inch	
 13 ... 15 mm / 0.51 ... 0.59 inch	

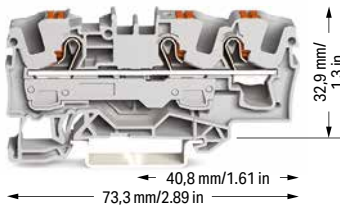
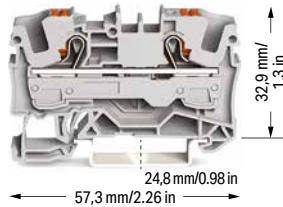

2-conductor through terminal block; with push-button

Color	Item No.	Pack. Unit
gray ⑤	2206-1201 ④	50
blue ⑤	2206-1204 ③ ④	50

3-conductor through terminal block; with push-button

Color	Item No.	Pack. Unit
gray ⑤	2206-1301 ④	25
blue ⑤	2206-1304 ③ ④	25

2-conductor ground terminal block; with push-button

green-yellow ⑤	2206-1207 ④	50
----------------	-------------	----

3-conductor ground terminal block; with push-button

green-yellow ⑤	2206-1307 ④	25
----------------	-------------	----

Accessories; item-specific

End and intermediate plate; 1 mm thick

orange	2006-1292	100 (25)
gray	2006-1291	100 (25)

Accessories; item-specific

End and intermediate plate; 1 mm thick

orange	2006-1392	100 (25)
gray	2006-1391	100 (25)

Separator; oversized; 2 mm thick

orange	2006-1294	100 (25)
gray	2006-1293	100 (25)

Separator; oversized; 2 mm thick

orange	2006-1394	100 (25)
gray	2006-1393	100 (25)

Accessories; 2206 Series

Appropriate marking systems: WMB/WMB Inline/Marking strips

Ex e/Ex i separator; orange; 3 mm thick

120 mm	209-191	50 (25)
--------	---------	---------

Spacer module; snaps together; bridges commoned terminal blocks

gray	2006-549	50 (25)
------	----------	---------

Push-in type jumper bar; insulated; I_N 41 A; light gray

2-way	2006-402	25
3-way	2006-403	25
4-way	2006-404	25
5-way	2006-405	25

Test plug adapter; for 4 mm Ø test plug

gray	2009-174	100 (25)
------	----------	----------

Push-in type jumper bar; insulated; I_N 41 A; light gray

1 to 3	2006-433	25
1 to 4	2006-434	25
1 to 5	2006-435	25

Testing tap; for max. 2.5 mm²

gray	2009-182	100 (25)
------	----------	----------

Star point jumper; insulated; I_N = I_N terminal block; light gray

1-3-5	2006-405/011-000	25
-------	------------------	----

Marking strip; plain; 11 mm wide; 50 m reel

white	2009-110	1
-------	----------	---

Step-down jumper; insulated; commons 6/4 mm² (10/12 AWG) to 4/2.5/1.5 mm² (12/14/16 AWG); I_N 32 A

light gray	2006-499	25
------------	----------	----

WMB marking card; white; 10 strips with 10 markers/card; 5 ... 5.2 mm stretchable

plain	793-5501	5
-------	----------	---

Modular connector; snaps together; for jumper contact slot

gray	2006-511	50 (25)
------	----------	---------

① Conductor range: 0.5 ... 10 mm² "s+f-st"; Push-in termination: 2.5 ... 10 mm² "s" and 2.5 ... 6 mm² "insulated ferrules; 12 mm" Depending on the conductor characteristic, a conductor with a smaller cross section can also be inserted via push-in termination.

② 800 V = rated voltage
8 kV = rated impulse voltage
3 = pollution degree (see Section 15)

③ Terminal blocks with a blue insulated housing are suitable for Ex i applications.

④ Terminal blocks with an Ex mark are suitable for Ex e II applications.
550 V; 41 A
33 A jumper (see Section 15)

Please observe the application notes:
Jumpers, from page 177
Testing accessories, from page 170
Marking, from page 640

Approvals and corresponding ratings, visit www.wago.com



Step-down jumper (2006-499) commons 6/4 mm² (10/12 AWG) terminal blocks (2206/2204 Series) with 4/2.5/1.5 mm² (AWG 12/14/16) terminal blocks (2204/2202/2201 Series).

Through Terminal Block, Ground Conductor Terminal Block TOPJOB® S; with Push-Button 10 (16) mm²; 2210 Series

Technical Data

0,5 ... 10 (16) mm ² ①	20 ... 6 AWG
800 V/8 kV/3 ②	600 V, 65 A ③
I _N 57 A (76 A)	600 V, 64 A ④
Terminal block width: 10 mm / 0.394 inch	
 17 ... 19 mm / 0.67 ... 0.75 inch	

Technical Data

0,5 ... 10 (16) mm ² ①	20 ... 6 AWG
800 V/8 kV/3 ②	600 V, 65 A ③
I _N 57 A (76 A)	600 V, 64 A ④
Terminal block width: 10 mm / 0.394 inch	
 17 ... 19 mm / 0.67 ... 0.75 inch	

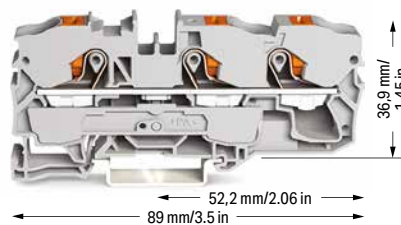
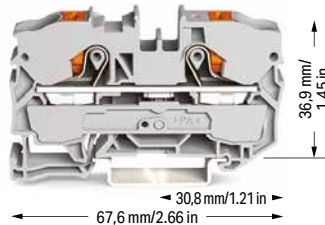

2-conductor through terminal block; with push-button

Color	Item No.	Pack. Unit
gray ⑤	2210-1201 ④	25
blue ⑤	2210-1204 ③ ④	25

3-conductor through terminal block; with push-button

Color	Item No.	Pack. Unit
gray ⑤	2210-1301 ④	25
blue ⑤	2210-1304 ③ ④	25



2-conductor ground terminal block; with push-button

green-yellow ⑤	2210-1207 ④	25
----------------	-------------	----



3-conductor ground terminal block; with push-button

green-yellow ⑤	2210-1307 ④	25
----------------	-------------	----

Accessories; item-specific

End and intermediate plate; 1 mm thick			
	orange	2010-1292	100 (25)
	gray	2010-1291	100 (25)

Accessories; item-specific

End and intermediate plate; 1 mm thick			
	orange	2010-1392	100 (25)
	gray	2010-1391	100 (25)

Accessories; 2210 Series

Appropriate marking systems: WMB/WMB Inline/Marking strips

Ex e/Ex i separator; orange; 3 mm thick

	120 mm	209-191	50 (25)
---	--------	---------	---------

Spacer module; snaps together; bridges commoned terminal blocks

	gray	2010-549	50 (25)
---	------	----------	---------

Push-in type jumper bar; insulated; I_N 57 A; light gray

	2-way	2010-402	25
	3-way	2010-403	25
	4-way	2010-404	25
	5-way	2010-405	25

Test plug adapter; for 4 mm Ø test plug

	gray	2009-174	100 (25)
---	------	----------	----------

Push-in type jumper bar; insulated; I_N 57 A; light gray

	1 to 3	2010-433	25
	1 to 4	2010-434	25
	1 to 5	2010-435	25

Testing tap; for max. 2.5 mm²

	gray	2009-182	100 (25)
---	------	----------	----------

Star point jumper; insulated; I_N = I_N terminal block; light gray

	1-3-5	2010-405/011-000	25
---	-------	------------------	----

Marking strip; plain; 11 mm wide; 50 m reel

	white	2009-110	1
---	-------	----------	---

Step-down jumper; insulated; commons 16/10 mm² (8/10 AWG) to 10/6/4/2.5 mm² (8/10/12/14 AWG); I_N 57 A; light gray

	light gray	2016-499	25
---	------------	----------	----

WMB marking card; white; 10 strips with 10 markers/card; 5 ... 5.2 mm stretchable

	plain	793-5501	5
---	-------	----------	---

Finger guard; touch-proof cover protects unused conductor entries

	yellow	2010-100	100 (25)
---	--------	----------	----------

Modular connector; snaps together; for jumper contact slot

	gray	2010-511	50 (25)
---	------	----------	---------

① Conductor range: 0.5 ... 16 mm² "s+f-st"; Push-in termination: 4 ... 16 mm² "s" and 4 ... 10 mm² "insulated ferrules; 18 mm"
Depending on the conductor characteristic, a conductor with a smaller cross section can also be inserted via push-in termination.

② 800 V = rated voltage
8 kV = rated impulse voltage
3 = pollution degree (see Section 15)

③ Terminal blocks with a blue insulated housing are suitable for Ex i applications.

④ Terminal blocks with an Ex mark are suitable for Ex e II applications.
550 V; 54 A
50 A jumper (see Section 15)

Please observe the application notes:
Jumpers, from page 177
Testing accessories, from page 170
Marking, from page 640

Approvals and corresponding ratings, visit www.wago.com

Through Terminal Block, Ground Conductor Terminal Block TOPJOB® S; with Push-Button 16 (25 "f-st") mm²; 2216 Series

1

Technical Data

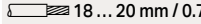

0.5 ... 16 (25 "f-st") mm ² ①	20 ... 4 AWG
800 V/8 kV/3 ②	600 V, 85 A ③
I _N 76 A (90 A)	600 V, 85 A ④
Terminal block width: 12 mm / 0.472 inch	
 18 ... 20 mm / 0.71 ... 0.79 inch	

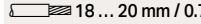
Technical Data



0.5 ... 16 (25 "f-st") mm ² ①	20 ... 4 AWG
800 V/8 kV/3 ②	600 V, 85 A ③
I _N 76 A (90 A)	600 V, 85 A ④
Terminal block width: 12 mm / 0.472 inch	
 18 ... 20 mm / 0.71 ... 0.79 inch	



2-conductor through terminal block; with push-button

Color	Item No.	Pack. Unit
 gray ⑤	2216-1201 ④	20
 blue ⑤	2216-1204 ③ ④	20

3-conductor through terminal block; with push-button

Color	Item No.	Pack. Unit
 gray ⑤	2216-1301 ④	20
 blue ⑤	2216-1304 ③ ④	20

2-conductor ground terminal block; with push-button
15 mm high DIN-35 rails shall be used for a current load higher than 76 A!



 green-yellow ⑤	2216-1207 ④	50
---	-------------	----

3-conductor ground terminal block; with push-button
15 mm high DIN-35 rails shall be used for a current load higher than 76 A!

 green-yellow ⑤	2216-1307 ④	20
--	-------------	----



Accessories; item-specific

End and intermediate plate; 1 mm thick

	orange	2016-1292	100 (25)
	gray	2016-1291	100 (25)

Accessories; item-specific

End and intermediate plate; 1 mm thick

	orange	2016-1392	100 (25)
	gray	2016-1391	100 (25)

Accessories; 2216 Series

Appropriate marking systems: WMB/WMB Inline/Marking strips

Ex e/Ex i separator; orange; 3 mm thick

	120 mm	209-191	50 (25)
--	--------	---------	---------

Spacer module; snaps together; bridges commoned terminal blocks

	gray	2016-549	50 (25)
---	------	----------	---------

Push-in type jumper bar; insulated; I_N 76 A; light gray

	2-way	2016-402	25
	3-way	2016-403	25
	4-way	2016-404	25
	5-way	2016-405	25

Test plug adapter; for 4 mm Ø test plug

	gray	2009-174	100 (25)
---	------	----------	----------

Push-in type jumper bar; insulated; I_N 76 A; light gray

	1 to 3	2016-433	25
	1 to 4	2016-434	25
	1 to 5	2016-435	25

Testing tap; for max. 2.5 mm²

	gray	2009-182	100 (25)
---	------	----------	----------

Star point jumper; insulated; I_N = I_N terminal block; light gray

	1-3-5	2016-405/011-000	25
---	-------	------------------	----

Marking strip; plain; 11 mm wide; 50 m reel

	white	2009-110	1
---	-------	----------	---

Step-down jumper; insulated; commons 16/10 mm² (8/10 AWG) to 10/6/4/2.5 mm² (8/10/12/14 AWG); I_N 57 A

	light gray	2016-499	25
---	------------	----------	----

WMB marking card; white; 10 strips with 10 markers/card; 5 ... 5.2 mm stretchable

	plain	793-5501	5
---	-------	----------	---

Finger guard; touch-proof cover protects unused conductor entries

	yellow	2016-100	100 (25)
---	--------	----------	----------

Modular connector; snaps together; for jumper contact slot

	gray	2016-511	50 (25)
---	------	----------	---------

① Conductor range: 0.5 ... 16 mm² "s+f-st", 25 mm² "f-st"; Push-in termination: 6 ... 16 mm² "s" and 6 ... 16 mm² "insulated ferrules; 18 mm"
Depending on the conductor characteristic, a conductor with a smaller cross section can also be inserted via push-in termination.

② 800 V = rated voltage
8 kV = rated impulse voltage
3 = pollution degree (see Section 15)

③ Terminal blocks with a blue housing are suitable for Ex i applications.

④ Terminal blocks with an Ex mark are suitable for Ex e II applications.
550 V; 76 A
65 A jumper (see Section 15)

Please observe the application notes:
Jumpers, from page 177
Testing accessories, from page 171
Marking, from page 640

Approvals and corresponding ratings, visit www.wago.com

Rail-Mount Terminal Blocks TOPJOB® S; with Push-in CAGE CLAMP®

2000 to 2016 Series

Description and Installation

1



Push-in termination of solid and ferruled conductors

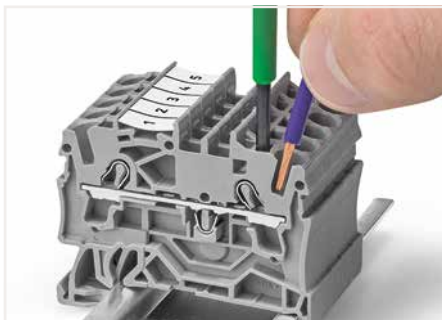

Insert fine-stranded conductors via operating tool.

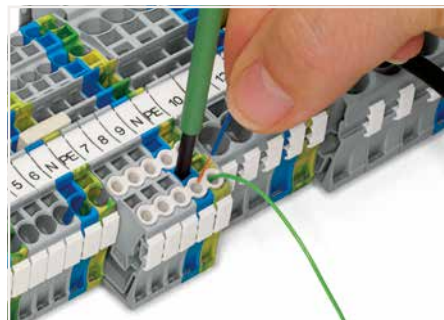

Conductor termination – insulation stop



Insert push-in type jumper bar and push down until it hits backstop.



Custom jumpers are created by breaking and removing jumper contacts (2000, 2001, 2002, 2004 Series).

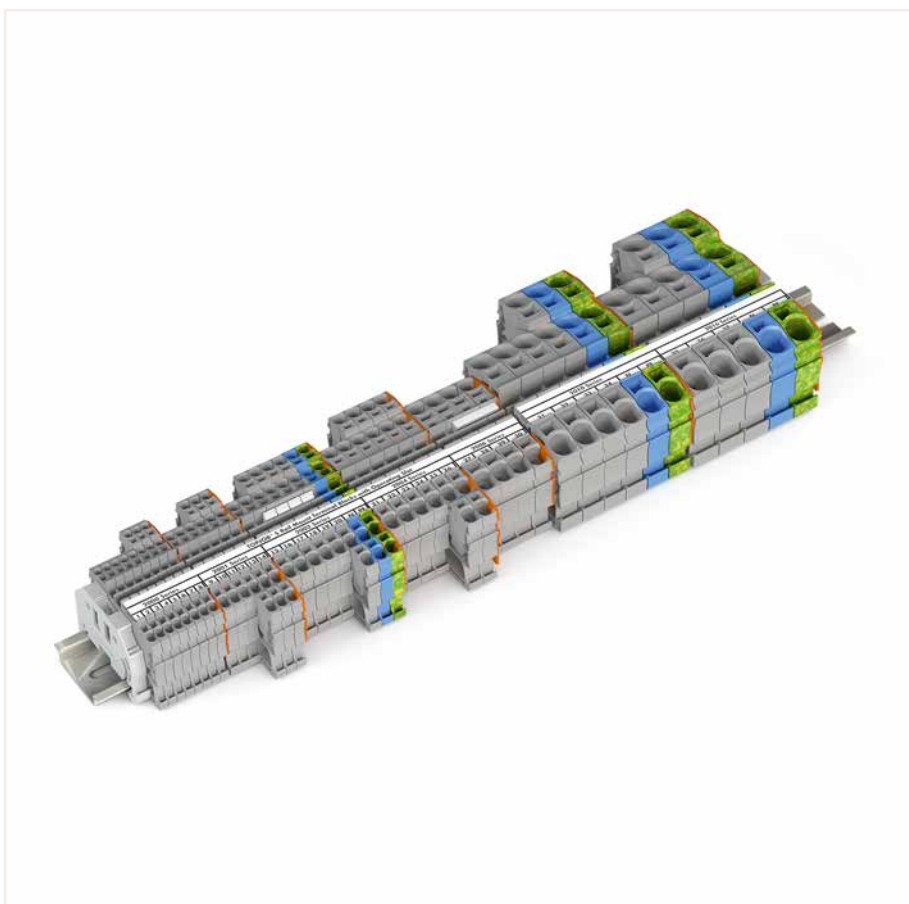

Push-in type jumper bar:
Marking with a felt-tip pen.

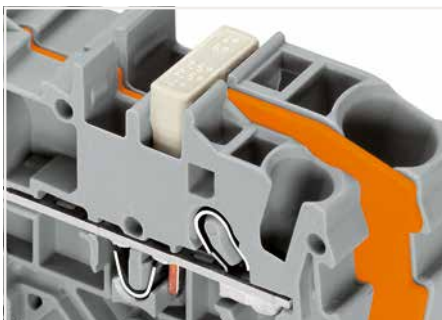

Commoning with step-down jumpers.



This star point jumper was specifically developed to create a "star point" and is used on motor terminal boards equipped with Rail-Mount Terminal Blocks TOPJOB® S.



Push-in CAGE CLAMP® terminates the following copper conductors:
solid "s"



stranded "st"



fine-stranded "f-st",
also with tinned
single strands

PUSH-IN CAGE CLAMP®

1

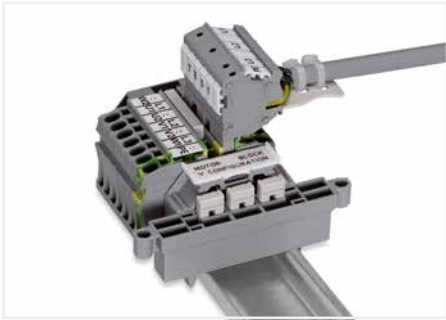

Rail-mount terminal block assembly for electric motor wiring



L-type test plug modules fitted in a triple-deck terminal block



Testing tap (2009-182) for tool-free connection of test cables up to 2.5 mm² (12 AWG) – compatible with 2000 to 2016 Series

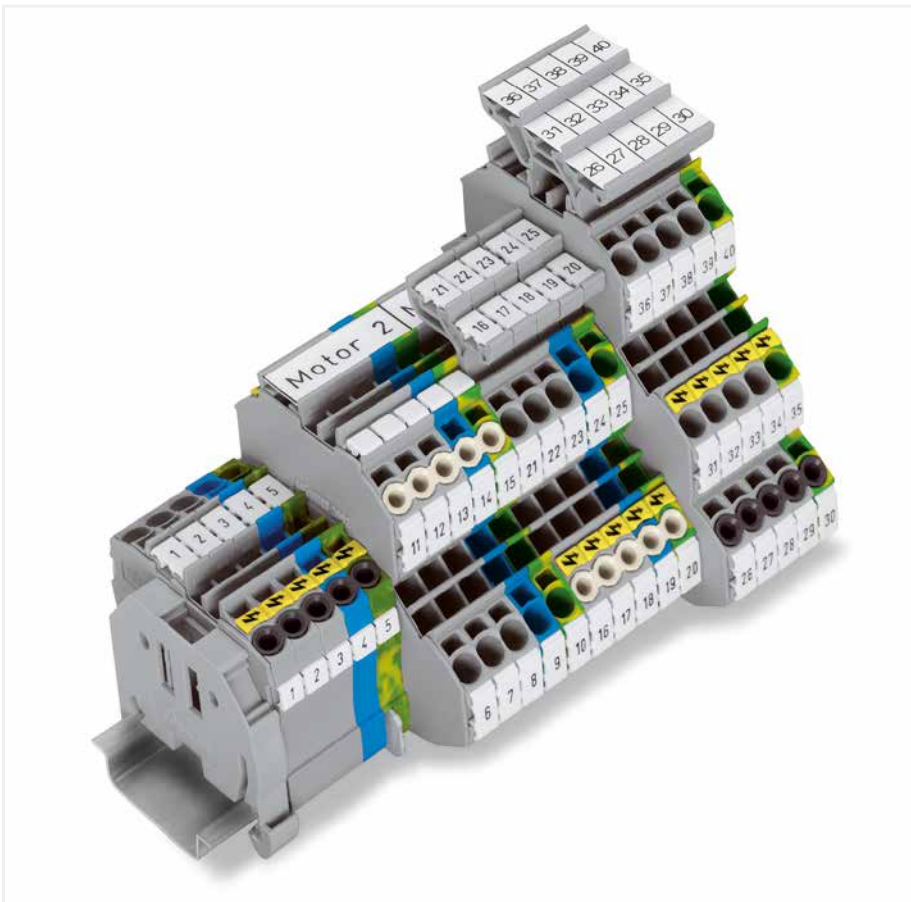

Test plug adapter (2009-174, CAT I) for 4 mm Ø plugs – compatible with 2000 to 2016 Series



Group marker carrier (2009-163) for marking strips (2009-110)

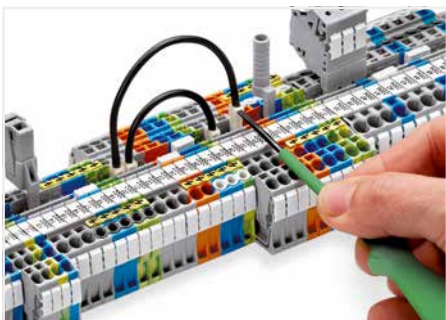

Push down the wire jumper until fully inserted. Lift the jumper with an operating tool for rewiring.

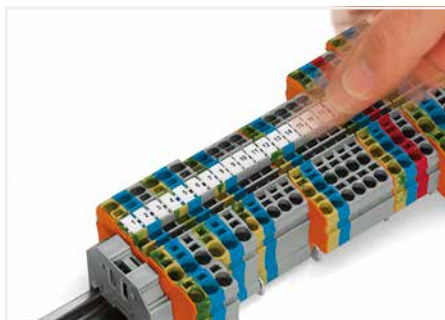

Snapping a marking strip into the marker slot.

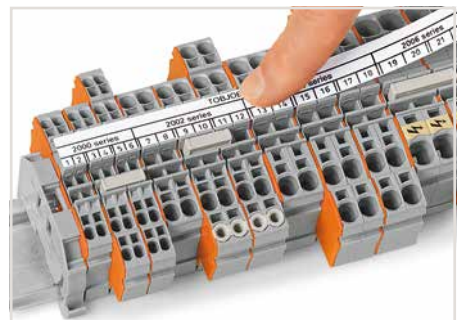

Snapping a marking strip into the marker slot.



fine-stranded, tip-bonded



fine-stranded, with ferrule (gastight crimped)



fine-stranded, with pin terminal (gastight crimped)

Through Terminal Block, Ground Conductor Terminal Block, Double-Potential Terminal Block TOPJOB® S 1 (1.5) mm²; 2000 Series

1

Technical Data	
0.14 ... 1 (1.5) mm ² ①	24 ... 16 AWG
800 V/8 kV/3 ②	600 V, 15 A ③
I _N 13.5 A (17.5 A)	600 V, 10 A ④
Terminal block width: 3.5 mm / 0.138 inch	
 9 ... 11 mm / 0.35 ... 0.43 inch	

Technical Data	
0.14 ... 1 (1.5) mm ² ①	24 ... 16 AWG
800 V/8 kV/3 ②	600 V, 15 A ③
I _N 13.5 A (17.5 A)	600 V, 10 A ④
Terminal block width: 3.5 mm / 0.138 inch	
 9 ... 11 mm / 0.35 ... 0.43 inch	

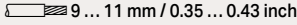
Technical Data	
0.14 ... 1 (1.5) mm ² ①	24 ... 16 AWG
800 V/8 kV/3 ②	600 V, 15 A ③
I _N 13.5 A (17.5 A)	600 V, 10 A ④
Terminal block width: 3.5 mm / 0.138 inch	
 9 ... 11 mm / 0.35 ... 0.43 inch	

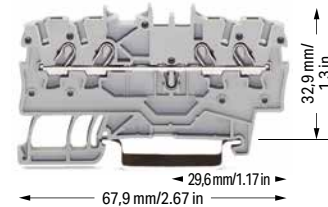
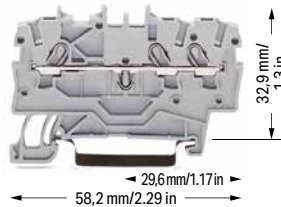
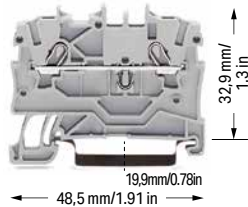

2-conductor through terminal block

Color	Item No.	Pack. Unit
gray ⑤	2000-1201 ④	100
blue ⑤	2000-1204 ③ ④	100
orange ⑤	2000-1202 ④	100
red ⑤	2000-1203 ④	100
black ⑤	2000-1205 ④	100
yellow ⑤	2000-1206 ④	100

3-conductor through terminal block

Color	Item No.	Pack. Unit
gray ⑤	2000-1301 ④	100
blue ⑤	2000-1304 ③ ④	100
orange ⑤	2000-1302 ④	100
red ⑤	2000-1303 ④	100
black ⑤	2000-1305 ④	100
yellow ⑤	2000-1306 ④	100

4-conductor through terminal block

Color	Item No.	Pack. Unit
gray ⑤	2000-1401 ④	100
blue ⑤	2000-1404 ③ ④	100
orange ⑤	2000-1402 ④	100
red ⑤	2000-1403 ④	100
black ⑤	2000-1405 ④	100
yellow ⑤	2000-1406 ④	100

2-conductor ground terminal block

green-yellow ⑤	2000-1207 ④	100
----------------	-------------	-----

3-conductor ground terminal block

green-yellow ⑤	2000-1307 ④	100
----------------	-------------	-----

4-conductor ground terminal block

green-yellow ⑤	2000-1407 ④	100
----------------	-------------	-----

Accessories; item-specific

End and intermediate plate; 0.7 mm thick

 orange	2000-1292	100 (25)
 gray	2000-1291	100 (25)

Accessories; item-specific

End and intermediate plate; 0.7 mm thick

 orange	2000-1392	100 (25)
 gray	2000-1391	100 (25)

Accessories; item-specific

End and intermediate plate; 0.7 mm thick

 orange	2000-1492	100 (25)
 gray	2000-1491	100 (25)

Ex e/Ex i separator; orange; 3 mm thick

 90 mm	209-190	50 (25)
 120 mm	209-191	50 (25)

Ex e/Ex i separator; orange; 3 mm thick

 120 mm	209-191	50 (25)
--	---------	---------









Ex e/Ex i separator; orange; 3 mm thick

 120 mm	209-191	50 (25)
--	---------	---------

Accessories; 2000 Series

Appropriate marking systems: WMB/WMB Inline/Marking strips

Push-in type jumper bar; insulated; I_N 14 A; light gray

 2-way	2000-402	25
 3-way	2000-403	25
 4-way	2000-404	25
 5-way	2000-405	25
 6-way	2000-406	25
 7-way	2000-407	25
 8-way	2000-408	25
 9-way	2000-409	25
 10-way	2000-410	25

Delta jumper; insulated; I_N = I_N terminal block; light gray

 1-2 3-4 5-6	2000-406/020-000	25
---	------------------	----

Spacer module; snaps together; bridges commoned terminal blocks

 gray	2000-549	100 (25)
--	----------	----------









Star point jumper; insulated; I_N = I_N terminal block; light gray

 1-3-5	2000-405/011-000	25
---	------------------	----

Test plug adapter; for 4 mm Ø test plug

 gray	2009-174	100 (25)
--	----------	----------

Push-in type jumper bar; insulated; I_N 14 A; light gray

 1 to 3	2000-433	25
 1 to 4	2000-434	25
 1 to 5	2000-435	25
 1 to 6	2000-436	25
 1 to 7	2000-437	25
 1 to 8	2000-438	25
 1 to 9	2000-439	25
 1 to 10	2000-440	25

Push-in type wire jumper; insulated; 0.75 mm² conductor cross-section; I_N 9 A

 L = 60 mm	2009-402	100 (10)
 L = 110 mm	2009-404	100 (10)
 L = 250 mm	2009-406	100 (10)

Testing tap; for max. 2.5 mm²

 gray	2009-182	100 (25)
--	----------	----------

Modular connector; snaps together; for jumper contact slot

Terminal block width: 5 mm / 0.197 inch

 gray	2000-511	100 (25)
--	----------	----------

Protective warning marker; with black high-voltage symbol; for 5 terminal blocks

 yellow	2000-115	100 (25)
--	----------	----------

Modular connector; snaps together; for jumper contact slot

 gray	2000-510	100 (25)
--	----------	----------

Technical Data

0.14 ... 1 (1.5) mm ² ①	24 ... 16 AWG
800 V/8 kV/3 ②	600 V, 15 A ③
I _N 13.5 A (17.5 A)	600 V, 10 A ④
Terminal block width: 3.5 mm / 0.138 inch	
9 ... 11 mm / 0.35 ... 0.43 inch	

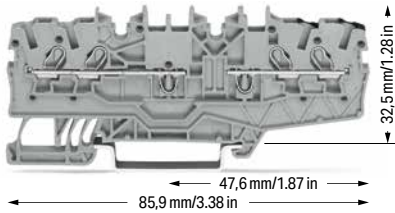

Double-potential terminal block; both potentials can be commoned

Color	Item No.	Pack. Unit
○ gray ⑤	2000-2141 ⑥	50

- ① Conductor range: 0.14 ... 1.5 mm² "s+f-st"; Push-in termination: 0.5 ... 1.5 mm² "s" and 0.5 ... 0.75 mm² "insulated ferrules; 10 mm" Depending on the conductor characteristic, a conductor with a smaller cross section can also be inserted via push-in termination.
- ② 800 V = rated voltage
8 kV = rated impulse voltage
3 = pollution degree (see Section 15)
- ③ Terminal blocks with a blue insulated housing are suitable for Ex i applications.
- ④ Terminal blocks with an Ex mark are suitable for Ex e II applications.
550 V; 13 A
12 A jumper (see Section 15)

Please observe the application notes:
Separator for Ex e/Ex i applications, see page 63
Jumpers, from page 174
Testing accessories, from page 168
Marking, from page 640

Approvals and corresponding ratings, visit www.wago.com

Accessories; item-specific

End and intermediate plate; 0.7 mm thick

	orange	2000-2196	100 (25)
	gray	2000-2195	100 (25)

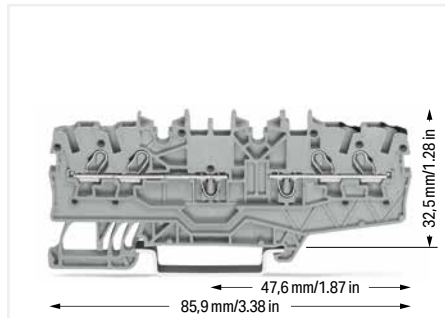

Front-entry double-potential terminal blocks are space savers. Two independent feedthrough circuits are placed in one insulated housing on one level in just 3.5 mm. This achieves a width of just 1.75 mm versus standard through terminal blocks. Input and output of a circuit are placed on the same side of the terminal block. Both circuits can be individually marked according to input and output.



Standard and quick marking options:
Three marker slots are available for both individual markers and marking strips.

Marking strip; plain; 11 mm wide; 50 m reel

	white	2009-110	1
---	-------	----------	---

WMB Inline; plain; 2,300 WMB markers (3.5 mm)/reel

	white	2009-113	1
---	-------	----------	---

WMB marking card; white; 10 strips with 10 markers/card; for 3.5 mm terminal block width

	plain	793-3501	5
---	-------	----------	---



2009-193 Group Marker Carrier (equipped with marking strips) for all 2001 to 2016 Series Rail-Mount Terminal Blocks TOPJOB® S
Do not use on an end plate!

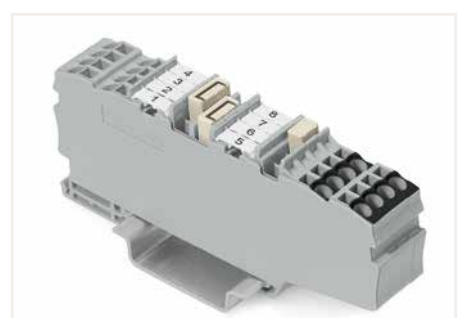



Standard and quick marking options:
Four marker slots (double-potential terminal blocks) are available for both individual markers and marking strips.

Through Terminal Block, Ground Conductor Terminal Block, Shield Conductor Terminal Block, Double-Potential Terminal Block TOPJOB® S

1.5 (2.5) mm²; 2001 Series

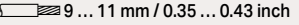
Technical Data	
0.25 ... 1.5 (2.5) mm ² ①	22 ... 14 AWG
800 V/8 kV/3 ②	600 V, 15 A ③
I _N 18 A (24 A)	600 V, 15 A ④
Terminal block width: 4.2 mm / 0.165 inch	
 9 ... 11 mm / 0.35 ... 0.43 inch	

Technical Data	
0.25 ... 1.5 (2.5) mm ² ①	22 ... 14 AWG
800 V/8 kV/3 ②	600 V, 15 A ③
I _N 18 A (24 A)	600 V, 15 A ④
Terminal block width: 4.2 mm / 0.165 inch	
 9 ... 11 mm / 0.35 ... 0.43 inch	

Technical Data	
0.25 ... 1.5 (2.5) mm ² ①	22 ... 14 AWG
800 V/8 kV/3 ②	600 V, 15 A ③
I _N 18 A (24 A)	600 V, 15 A ④
Terminal block width: 4.2 mm / 0.165 inch	
 9 ... 11 mm / 0.35 ... 0.43 inch	

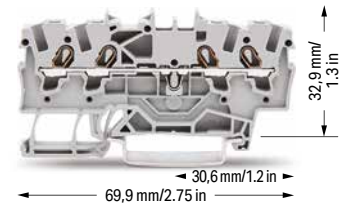
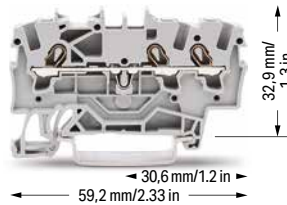
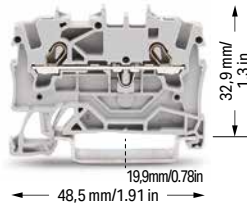

2-conductor through terminal block

Color	Item No.	Pack. Unit
gray ⑤	2001-1201 ④	100
blue ⑤	2001-1204 ③ ④	100
orange ⑤	2001-1202 ④	100
red ⑤	2001-1203 ④	100
black ⑤	2001-1205 ④	100
yellow ⑤	2001-1206 ④	100

3-conductor through terminal block

Color	Item No.	Pack. Unit
gray ⑤	2001-1301 ④	100
blue ⑤	2001-1304 ③ ④	100
orange ⑤	2001-1302 ④	100
red ⑤	2001-1303 ④	100
black ⑤	2001-1305 ④	100
yellow ⑤	2001-1306 ④	100

4-conductor through terminal block

Color	Item No.	Pack. Unit
gray ⑤	2001-1401 ④	100
blue ⑤	2001-1404 ③ ④	100
orange ⑤	2001-1402 ④	100
red ⑤	2001-1403 ④	100
black ⑤	2001-1405 ④	100
yellow ⑤	2001-1406 ④	100

2-conductor ground terminal block

green-yellow ⑤	2001-1207 ④	100
----------------	-------------	-----

3-conductor ground terminal block

green-yellow ⑤	2001-1307 ④	100
----------------	-------------	-----

4-conductor ground terminal block

green-yellow ⑤	2001-1407 ④	100
----------------	-------------	-----

2-conductor shield terminal block

white	2001-1208	100
-------	-----------	-----

3-conductor shield terminal block

white	2001-1308	100
-------	-----------	-----

4-conductor shield terminal block

white	2001-1408	100
-------	-----------	-----

Other terminal blocks with the same profile:

Diode	2001-1211/1000-411	Page 146
-------	--------------------	----------

Other terminal blocks with the same profile:

Diode	2001-1311/1000-411	Page 146
LED	2001-1321/1000-434	Page 146

Other terminal blocks with the same profile:

Diode	2001-1411/1000-411	Page 146
LED	2001-1421/1000-434	Page 146

Accessories; item-specific

End and intermediate plate; 0.8 mm thick

orange	2002-1292	100 (25)
gray	2002-1291	100 (25)

Accessories; item-specific

End and intermediate plate; 0.8 mm thick

orange	2002-1392	100 (25)
gray	2002-1391	100 (25)

Accessories; item-specific

End and intermediate plate; 0.8 mm thick

orange	2002-1492	100 (25)
gray	2002-1491	100 (25)

Separator; oversized; 2 mm thick

orange	2002-1294	100 (25)
gray	2002-1293	100 (25)

Separator; oversized; 2 mm thick

orange	2002-1394	100 (25)
gray	2002-1393	100 (25)

Separator; oversized; 2 mm thick

orange	2002-1494	100 (25)
gray	2002-1493	100 (25)

Ex e/Ex i separator; orange; 3 mm thick

90 mm	209-190	50 (25)
120 mm	209-191	50 (25)

Ex e/Ex i separator; orange; 3 mm thick

120 mm	209-191	50 (25)
--------	---------	---------

Ex e/Ex i separator; orange; 3 mm thick

120 mm	209-191	50 (25)
--------	---------	---------

Accessories; 2001 Series

Appropriate marking systems: WMB/WMB Inline/Marking strips

Insulation stop; 5 pcs/strip; 0.25 ... 0.5 mm²

light gray	2001-171	200 (25)
------------	----------	----------

Push-in type jumper bar; insulated; I_N 18 A; light gray

2-way	2001-402	25
3-way	2001-403	25
4-way	2001-404	25
5-way	2001-405	25
6-way	2001-406	25
7-way	2001-407	25
8-way	2001-408	25
9-way	2001-409	25
10-way	2001-410	25

Push-in type jumper bar; insulated; I_N 18 A; light gray

1 to 3	2001-433	25
1 to 4	2001-434	25
1 to 5	2001-435	25
1 to 6	2001-436	25
1 to 7	2001-437	25
1 to 8	2001-438	25
1 to 9	2001-439	25
1 to 10	2001-440	25

Protective warning marker; with black high-voltage symbol; for 5 terminal blocks

yellow	2001-115	100 (25)
--------	----------	----------

Technical Data

0.25 ... 1.5 (2.5) mm ² ①	22 ... 14 AWG
800 V/8 kV/3 ②	600 V, 15 A ③
I _N 18 A (24 A)	600 V, 15 A ④
Terminal block width: 4.2 mm / 0.165 inch	

9 ... 11 mm / 0.35 ... 0.43 inch

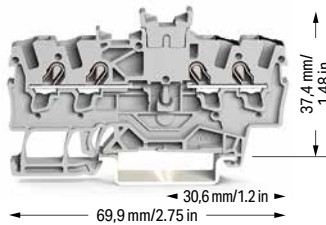

Double-potential terminal block; with push-button; with double, center marking slot
 Notice: This double potential terminal block cannot be commoned with push-in type jumper bars!

Color	Item No.	Pack. Unit
○ gray ⑤	2001-1441 ④	100

① Conductor range: 0.25 ... 2.5 mm² "s+f-st"; Push-in termination: 0.75 ... 2.5 mm² "s" and 0.75 ... 1.5 mm² "insulated ferrules; 12 mm"
 Depending on the conductor characteristic, a conductor with a smaller cross section can also be inserted via push-in termination.

② 800 V = rated voltage
 8 kV = rated impulse voltage
 3 = pollution degree (see Section 15)

③ Terminal blocks with a blue insulated housing are suitable for Ex i applications.

④ Terminal blocks with an Ex mark are suitable for Ex e II applications.
 550 V; 17 A
 16 A jumper
 Double-potential terminal block 550 V; 15 A (see Section 15)

Please observe the application notes:
 Separator for Ex e/Ex i applications, see page 63
 Step-down jumpers, see page 67
 Jumpers, from page 177
 Testing accessories, from page 168
 Marking, from page 640

Approvals and corresponding ratings, visit www.wago.com

Accessories; 2001 Series

Appropriate marking systems:
 WMB/WMB Inline/Marking strips

Step-down jumper; insulated; commons 6/4 mm² (10/12 AWG) to 4/2.5/1.5 mm² (12/14/16 AWG); I_N 32 A



light gray 2006-499 25

Push-in type wire jumper; insulated; 1.5 mm² conductor cross-section; I_N 18 A



L = 60 mm 2009-412 100 (10)

L = 110 mm 2009-414 100 (10)

L = 250 mm 2009-416 100 (10)

Modular connector; snaps together; for jumper contact slot



gray 2001-511 100 (25)

Spacer module; snaps together; bridges commoned terminal blocks



gray 2001-549 100 (25)

Test plug adapter; for 4 mm Ø test plug



gray 2009-174 100 (25)

Testing tap; for max. 2.5 mm²



gray 2009-182 100 (25)

Marking strip; plain; 11 mm wide; 50 m reel





white 2009-110 1

Accessories; item-specific

End and intermediate plate; 0.9 mm thick

 orange	2002-1492	100 (25)
 gray	2002-1491	100 (25)

Separator; oversized; 2 mm thick

 orange	2002-1494	100 (25)
 gray	2002-1493	100 (25)

Delta jumper; insulated; I_N = I_N terminal block; light gray

 1-2 3-4 5-6	2001-406/020-000	25
---	------------------	----

Star point jumper; insulated; I_N = I_N terminal block; light gray

 1-3-5	2001-405/011-000	25
---	------------------	----

WMB Inline; plain; 2,000 WMB markers (4 mm)/reel; 4 ... 4.2 mm stretchable



white 2009-114 1

WMB marking card; white; 10 strips with 10 markers/card; 4 ... 4.2 mm stretchable



plain 793-4501 5

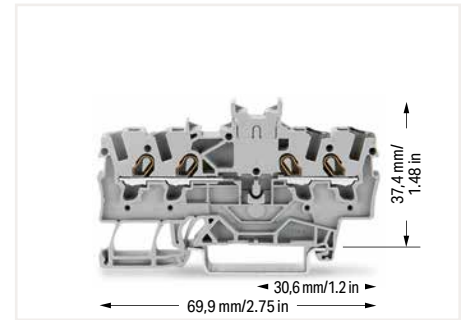

Notice: These double-potential terminal blocks cannot be commoned with push-in type jumper bars!
 Front-entry double-potential terminal blocks are space savers. Two independent feedthrough circuits are placed in one insulated housing on one level in just 4.2 mm. This achieves a width of just 2.1 mm versus standard through terminal blocks. Input and output of a circuit are placed on the same side of the terminal block. Both circuits can be individually marked according to input and output.

Through Terminal Block, Ground Conductor Terminal Block, Shield Conductor Terminal Block, Double-Potential Terminal Block TOPJOB® S

2.5 (4) mm²; 2002 Series

1

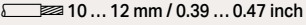
Technical Data	
0.25 ... 2.5 (4) mm ² ①	22 ... 12 AWG
800 V/8 kV/3 ②	600 V, 20 A ③
I _N 24 A (32 A)	600 V, 20 A ④
Terminal block width: 5.2 mm / 0.205 inch	
 10 ... 12 mm / 0.39 ... 0.47 inch	

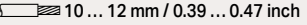
Technical Data	
0.25 ... 2.5 (4) mm ² ①	22 ... 12 AWG
800 V/8 kV/3 ②	600 V, 20 A ③
I _N 24 A (32 A)	600 V, 20 A ④
Terminal block width: 5.2 mm / 0.205 inch	
 10 ... 12 mm / 0.39 ... 0.47 inch	

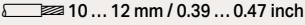
Technical Data	
0.25 ... 2.5 (4) mm ² ①	22 ... 12 AWG
800 V/8 kV/3 ②	600 V, 20 A ③
I _N 24 A (32 A)	600 V, 20 A ④
Terminal block width: 5.2 mm / 0.205 inch	
 10 ... 12 mm / 0.39 ... 0.47 inch	

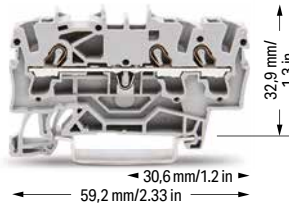
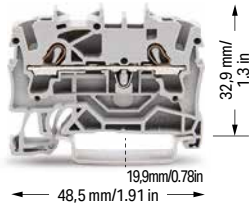

2-conductor through terminal block

Color	Item No.	Pack. Unit
gray ⑤	2002-1201 ④	100
blue ⑤	2002-1204 ③ ④	100
orange ⑤	2002-1202 ④	100
red ⑤	2002-1203 ④	100
black ⑤	2002-1205 ④	100
yellow ⑤	2002-1206 ④	100

3-conductor through terminal block

Color	Item No.	Pack. Unit
gray ⑤	2002-1301 ④	100
blue ⑤	2002-1304 ③ ④	100
orange ⑤	2002-1302 ④	100
red ⑤	2002-1303 ④	100
black ⑤	2002-1305 ④	100
yellow ⑤	2002-1306 ④	100

4-conductor through terminal block

Color	Item No.	Pack. Unit
gray ⑤	2002-1401 ④	100
blue ⑤	2002-1404 ③ ④	100
orange ⑤	2002-1402 ④	100
red ⑤	2002-1403 ④	100
black ⑤	2002-1405 ④	100
yellow ⑤	2002-1406 ④	100

2-conductor ground terminal block

green-yellow ⑤	2002-1207 ④	100
----------------	-------------	-----

3-conductor ground terminal block

green-yellow ⑤	2002-1307 ④	100
----------------	-------------	-----

4-conductor ground terminal block

green-yellow ⑤	2002-1407 ④	100
----------------	-------------	-----

2-conductor shield terminal block

white	2002-1208	100
-------	-----------	-----

3-conductor shield terminal block

white	2002-1308	100
-------	-----------	-----

4-conductor shield terminal block

white	2002-1408	100
-------	-----------	-----

Other terminal blocks with the same profile:

Diode	2002-1211/1000-411	Page 148
-------	--------------------	----------

Other terminal blocks with the same profile:

Diode	2002-1311/1000-411	Page 148
LED	2002-1321/1000-434	Page 148

Other terminal blocks with the same profile:

Diode	2002-1411/1000-411	Page 148
LED	2002-1421/1000-434	Page 148

Accessories; item-specific



End and intermediate plate; 0.8 mm thick			
	orange	2002-1292	100 (25)
	gray	2002-1291	100 (25)



Accessories; item-specific



End and intermediate plate; 0.8 mm thick			
	orange	2002-1392	100 (25)
	gray	2002-1391	100 (25)



Accessories; item-specific

End and intermediate plate; 0.8 mm thick			
	orange	2002-1492	100 (25)
	gray	2002-1491	100 (25)

Separator; oversized; 2 mm thick			
	orange	2002-1294	100 (25)
	gray	2002-1293	100 (25)

Separator; oversized; 2 mm thick			
	orange	2002-1394	100 (25)
	gray	2002-1393	100 (25)

Separator; oversized; 2 mm thick			
	orange	2002-1494	100 (25)
	gray	2002-1493	100 (25)

Ex e/Ex i separator; orange; 3 mm thick			
	90 mm	209-190	50 (25)
	120 mm	209-191	50 (25)









Ex e/Ex i separator; orange; 3 mm thick			
	120 mm	209-191	50 (25)









Ex e/Ex i separator; orange; 3 mm thick			
	120 mm	209-191	50 (25)

Accessories; 2002 Series

Appropriate marking systems: WMB/WMB Inline/Marking strips

Insulation stop; 5 pcs/strip; 0.25 ... 0.5 mm ²			
	light gray	2002-171	200 (25)

Push-in type jumper bar; insulated; I _N 25 A; light gray			
	2-way	2002-402	25
	3-way	2002-403	25
	4-way	2002-404	25
	5-way	2002-405	25
	6-way	2002-406	25
	7-way	2002-407	25
	8-way	2002-408	25
	9-way	2002-409	25
	10-way	2002-410	25

Push-in type jumper bar; insulated; I _N 25 A; light gray			
	1 to 3	2002-433	25
	1 to 4	2002-434	25
	1 to 5	2002-435	25
	1 to 6	2002-436	25
	1 to 7	2002-437	25
	1 to 8	2002-438	25
	1 to 9	2002-439	25
	1 to 10	2002-440	25

Insulation stop; 5 pcs/strip; 0.75 ... 1 mm ²			
	dark gray	2002-172	200 (25)

Protective warning marker; with black high-voltage symbol; for 5 terminal blocks			
	yellow	2002-115	100 (25)

Technical Data

0.25 ... 2.5 (4) mm ² ①	22 ... 12 AWG
800 V/8 kV/3 ②	600 V, 20 A ③
I _N 24 A (32 A)	600 V, 20 A ④
Terminal block width: 5.2 mm / 0.205 inch	
 10 ... 12 mm / 0.39 ... 0.47 inch	

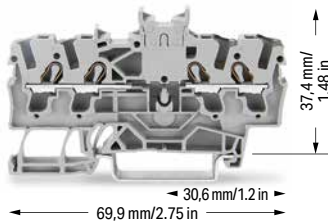

Double-potential terminal block; with double, center marking slot
 Notice: This double potential terminal block cannot be commoned with push-in type jumper bars!

Color	Item No.	Pack. Unit
gray ⑤	2002-1441 ⑥	100

① Conductor range: 0.25 ... 4 mm² "s+f-st";
 Push-in termination: 1 ... 4 mm² "s" and 1 ... 2.5 mm² "insulated ferrules, 12 mm"
 Depending on the conductor characteristic, a conductor with a smaller cross section can also be inserted via push-in termination.

② 800 V = rated voltage
 8 kV = rated impulse voltage
 3 = pollution degree (see Section 15)

③ Terminal blocks with a blue insulated housing are suitable for Ex i applications.

④ Terminal blocks with an Ex mark are suitable for Ex e II applications.
 550 V; 22 A
 Double-potential terminal block 550 V; 21 A
 20 A jumper (see Section 15)

Please observe the application notes:
 Separator for Ex e/Ex i applications, see page 63
 Step-down jumpers, see page 67
 Jumpers, from page 174
 Testing accessories, from page 169
 Marking, from page 640

Approvals and corresponding ratings, visit www.wago.com

Accessories; 2002 Series
 Appropriate marking systems:
 WMB/WMB Inline/Marking strips

Adjacent jumper for continuous commoning; insulated; I_N 25 A, light gray

	2-way	2002-400	25
---	-------	----------	----

Adjacent jumper for continuous commoning; insulated; I_N 25 A; 1 to 3

	light gray	2002-423	25
	red	2002-423/000-005	25
	blue	2002-423/000-006	25

Step-down jumper; insulated; commons 6/4 mm² (10/12 AWG) to 4/2.5/1.5 mm² (12/14/16 AWG); I_N 32 A

	light gray	2006-499	25
---	------------	----------	----

Accessories; item-specific

End and intermediate plate; 0.9 mm thick

	orange	2002-1492	100 (25)
	gray	2002-1491	100 (25)

Separator; oversized; 2 mm thick

	orange	2002-1494	100 (25)
	gray	2002-1493	100 (25)



Delta jumper; insulated; I_N = I_N terminal block; light gray

	1-2 3-4 5-6	2002-406/020-000	25
---	-------------	------------------	----

Star point jumper; insulated; I_N = I_N terminal block; light gray

	1-3-5	2002-405/011-000	25
---	-------	------------------	----

Staggered jumper; insulated; I_N 25 A; light gray

	2-way	2002-472	25
	3-way	2002-473	25
	4-way	2002-474	25
	5-way	2002-475	25
	6-way	2002-476	25
	7-way	2002-477	25
	8-way	2002-478	25
	9-way	2002-479	25
	10-way	2002-480	25
	11-way	2002-481	25
	12-way	2002-482	25

Customized staggered jumper; insulated; with contact lugs broken off at the factory and circuit printing; I_N 25 A; light gray

	1-3	2002-473/011-000	25
	1-3-5	2002-475/011-000	25
	1-3-5-7	2002-477/011-000	25
	1-3-5-7-9	2002-479/011-000	25
	1-3-5-7-9-11	2002-481/011-000	25

Push-in type wire jumper; insulated; 1.5 mm² conductor cross-section; I_N 18 A

	L = 60 mm	2009-412	100 (10)
	L = 110 mm	2009-414	100 (10)
	L = 250 mm	2009-416	100 (10)

Accessories; 2002 Series

Appropriate marking systems:
 WMB/WMB Inline/Marking strips

Modular connector; snaps together; for jumper contact slot

	gray	2002-511	100 (25)
---	------	----------	----------

Spacer module; snaps together; bridges commoned terminal blocks

	gray	2002-549	100 (25)
---	------	----------	----------

L-type test plug module; snaps together

	gray	2002-611	100 (25)
---	------	----------	----------

L-type spacer module; snaps together; bridges commoned terminal blocks

	gray	2002-649	100 (25)
---	------	----------	----------

Test plug adapter; for 4 mm Ø test plug

	gray	2009-174	100 (25)
---	------	----------	----------

Testing tap; for max. 2.5 mm²

	gray	2009-182	100 (25)
--	------	----------	----------

Marking strip; plain; 11 mm wide; 50 m reel

	white	2009-110	1
---	-------	----------	---

WMB Inline, plain; 1,500 WMB markers (5 mm)/reel; 5 ... 5.2 mm stretchable

	white	2009-115	1
---	-------	----------	---

WMB marking card; white; 10 strips with 10 markers/card; 5 ... 5.2 mm stretchable

	plain	793-5501	5
---	-------	----------	---

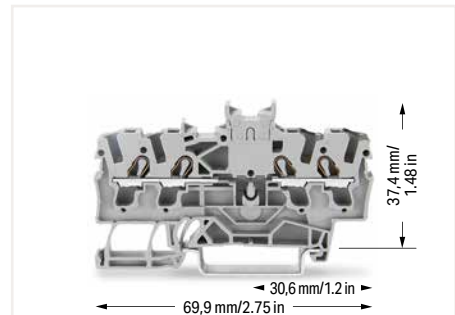

Notice: These double-potential terminal blocks cannot be commoned with push-in type jumper bars! Front-entry double-potential terminal blocks are space savers. Two independent feedthrough circuits are placed in one insulated housing on one level in just 5.2 mm. This achieves a width of just 2.6 mm versus standard through terminal blocks. Input and output of a circuit are placed on the same side of the terminal block. Both circuits can be individually marked according to input and output.

Through Terminal Block, Ground Conductor Terminal Block, Shield Conductor Terminal Block, TOPJOB® S

2.5 (4) mm²; 2002 Series

1

Technical Data

0.25 ... 2.5 (4) mm ² ①	22 ... 12 AWG
800 V/8 kV/3 ②	600 V, 20 A ③
I _N 24 A (32 A)	600 V, 20 A ④
Terminal block width: 5.2 mm / 0.205 inch	
 10 ... 12 mm / 0.39 ... 0.47 inch	

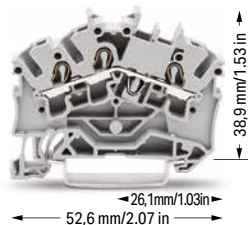

3-conductor through terminal block

Color	Item No.	Pack. Unit
gray ☺	2002-6301 ④	100
blue ☺	2002-6304 ③ ④	100
orange ☺	2002-6302 ④	100
red ☺	2002-6303 ④	100
black ☺	2002-6305 ④	100
yellow ☺	2002-6306 ④	100

3-conductor ground terminal block

green-yellow ☺	2002-6307 ④	100
----------------	-------------	-----

3-conductor shield terminal block

white	2002-6308	100
-------	-----------	-----

Accessories; 2002 Series

Appropriate marking systems:
WMB/WMB Inline/Marking strips

End and intermediate plate; 0.8 mm thick

orange	2002-6392	100 (25)
gray	2002-6391	100 (25)

Ex e/Ex i separator; orange; 3 mm thick

120 mm	209-191	50 (25)
--------	---------	---------

Insulation stop; 5 pcs/strip; 0.25 ... 0.5 mm²

light gray	2002-171	200 (25)
------------	----------	----------

Insulation stop; 5 pcs/strip; 0.75 ... 1 mm²

dark gray	2002-172	200 (25)
-----------	----------	----------

Protective warning marker; with black high-voltage symbol; for 5 terminal blocks

yellow	2002-115	100 (25)
--------	----------	----------

Push-in type jumper bar; insulated; I_N 25 A; light gray

2-way	2002-402	25
3-way	2002-403	25
4-way	2002-404	25
5-way	2002-405	25
6-way	2002-406	25
7-way	2002-407	25
8-way	2002-408	25
9-way	2002-409	25
10-way	2002-410	25

① Conductor range: 0.25 ... 4 mm² "s+f-st";
Push-in termination: 1 ... 4 mm² "s" and 1 ... 2.5 mm² "insulated ferrules, 12 mm"
Depending on the conductor characteristic, a conductor with a smaller cross section can also be inserted via push-in termination.

② 800 V = rated voltage
8 kV = rated impulse voltage
3 = pollution degree
(see Section 15)

③ Terminal blocks with a blue insulated housing are suitable for Ex i applications.

④ Terminal blocks with an Ex mark are suitable for Ex e II applications.
550 V; 22 A
20 A jumper
(see Section 15)

Please observe the application notes:
Separator for Ex e/Ex i applications, see page 63
Jumpers, from page 174
Testing accessories, from page 169
Marking, from page 640

Approvals and corresponding ratings, visit www.wago.com

Accessories; 2002 Series

Appropriate marking systems:
WMB/WMB Inline/Marking strips

Push-in type jumper bar; insulated; I_N 25 A; light gray

1 to 3	2002-433	25
1 to 4	2002-434	25
1 to 5	2002-435	25
1 to 6	2002-436	25
1 to 7	2002-437	25
1 to 8	2002-438	25
1 to 9	2002-439	25
1 to 10	2002-440	25

Delta jumper; insulated; I_N = I_N terminal block; light gray

1-2 3-4 5-6	2002-406/020-000	25
-------------	------------------	----

Star point jumper; insulated; I_N = I_N terminal block; light gray

1-3-5	2002-405/011-000	25
-------	------------------	----

Staggered jumper; insulated; I_N 25 A; light gray

2-way	2002-472	25
3-way	2002-473	25
4-way	2002-474	25
5-way	2002-475	25
6-way	2002-476	25
7-way	2002-477	25
8-way	2002-478	25
9-way	2002-479	25
10-way	2002-480	25
11-way	2002-481	25
12-way	2002-482	25

Customized staggered jumper; insulated; with contact lugs broken off at the factory and circuit printing; I_N 25 A; light gray

1-3	2002-473/011-000	25
1-3-5	2002-475/011-000	25
1-3-5-7	2002-477/011-000	25
1-3-5-7-9	2002-479/011-000	25
1-3-5-7-9-11	2002-481/011-000	25

Adjacent jumper for continuous commoning; insulated; I_N 25 A, light gray

2-way	2002-400	25
-------	----------	----

Accessories; 2002 Series

Appropriate marking systems:
WMB/WMB Inline/Marking strips

Adjacent jumper for continuous commoning; insulated; I_N 25 A; 1 to 3

light gray	2002-423	25
red	2002-423/000-005	25
blue	2002-423/000-006	25

Push-in type wire jumper; insulated; 1.5 mm² conductor cross-section; I_N 18 A

L = 60 mm	2009-412	100 (10)
L = 110 mm	2009-414	100 (10)
L = 250 mm	2009-416	100 (10)

Modular connector; snaps together; for jumper contact slot

gray	2002-511	100 (25)
------	----------	----------

Spacer module; snaps together; bridges commoned terminal blocks

gray	2002-549	100 (25)
------	----------	----------

L-type test plug module; snaps together

gray	2002-611	100 (25)
------	----------	----------

L-type spacer module; snaps together; bridges commoned terminal blocks

gray	2002-649	100 (25)
------	----------	----------

Test plug adapter; for 4 mm Ø test plug

gray	2009-174	100 (25)
------	----------	----------

Testing tap; for max. 2.5 mm²

gray	2009-182	100 (25)
------	----------	----------

Marking strip; plain; 11 mm wide; 50 m reel

white	2009-110	1
-------	----------	---

WMB Inline, plain; 1,500 WMB markers (5 mm)/reel; 5 ... 5.2 mm stretchable

white	2009-115	1
-------	----------	---

WMB marking card; white; 10 strips with 10 markers/card; 5 ... 5.2 mm stretchable

plain	793-5501	5
-------	----------	---

Through Terminal Block, Ground Conductor Terminal Block TOPJOB® S 2.5 (4) mm²; 2002 Series

Technical Data

0.25 ... 2.5 (4) mm ² ①	22 ... 12 AWG
800 V/8 kV/3 ①	600 V, 20 A ②
I _N 24 A (32 A)	600 V, 20 A ③
Terminal block width: 5.2 mm / 0.205 inch	
10 ... 12 mm / 0.39 ... 0.47 inch	



4-conductor through terminal block

Notice: This terminal block cannot be commoned with push-in type jumper bars!

Color	Item No.	Pack. Unit
gray ④	2002-6401 ④	100
blue ④	2002-6404 ④ ④	100
orange ④	2002-6402 ④	100
red ④	2002-6403 ④	100
black ④	2002-6405 ④	100
yellow ④	2002-6406 ④	100

4-conductor ground terminal block

green-yellow ④	2002-6407 ④	100
----------------	-------------	-----

Accessories; 2002 Series

Appropriate marking systems:
WMB/WMB Inline/Marking strips

End and intermediate plate; 0.8 mm thick

orange	2002-6392	100 (25)
gray	2002-6391	100 (25)

Ex e/Ex i separator; orange; 3 mm thick

120 mm	209-191	50 (25)
--------	---------	---------

Insulation stop; 5 pcs/strip; 0.25 ... 0.5 mm²

light gray	2002-171	200 (25)
------------	----------	----------

Insulation stop; 5 pcs/strip; 0.75 ... 1 mm²

dark gray	2002-172	200 (25)
-----------	----------	----------

Protective warning marker; with black high-voltage symbol; for 5 terminal blocks

yellow	2002-115	100 (25)
--------	----------	----------

Marking strip; plain; 11 mm wide; 50 m reel

white	2009-110	1
-------	----------	---

WMB Inline, plain; 1,500 WMB markers (5 mm)/reel; 5 ... 5.2 mm stretchable

white	2009-115	1
-------	----------	---

① Conductor range: 0.25 ... 4 mm² "s+f-st";
Push-in termination: 1 ... 4 mm² "s" and 1 ... 2.5 mm² "insulated ferrules, 12 mm"
Depending on the conductor characteristic, a conductor with a smaller cross section can also be inserted via push-in termination.

② 800 V = rated voltage
8 kV = rated impulse voltage
3 = pollution degree
(see Section 15)

③ Terminal blocks with a blue insulated housing are suitable for Ex i applications.

④ Terminal blocks with an Ex mark are suitable for Ex e II applications.
550 V; 22 A
20 A jumper
(see Section 15)

Please observe the application notes:
Separator for Ex e/Ex i applications, see page 63
Marking, from page 640

Approvals and corresponding ratings,
visit www.wago.com

Accessories; 2002 Series

Appropriate marking systems:
WMB/WMB Inline/Marking strips

WMB marking card; white; 10 strips with 10 markers/card;
5 ... 5.2 mm stretchable

plain	793-5501	5
-------	----------	---

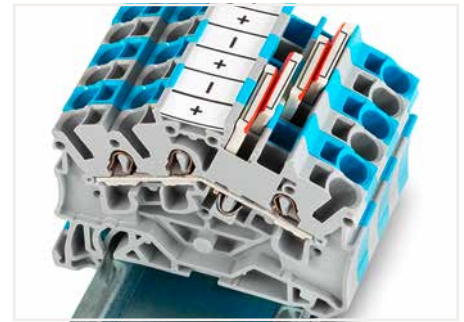

3- and 4-conductor terminal blocks (angled type):

WAGO's Rail-Mount Terminal Blocks TOPJOB® S have a 35-degree conductor entry angle permitting a very small bend radius and an extremely short wiring distance to the cable duct. These are space- and cost-saving solutions for switchgear and control cabinet applications that use the LSC wiring system from Lütze. The design allows cable duct to be placed very close to the terminal blocks, keeping its height relatively low.

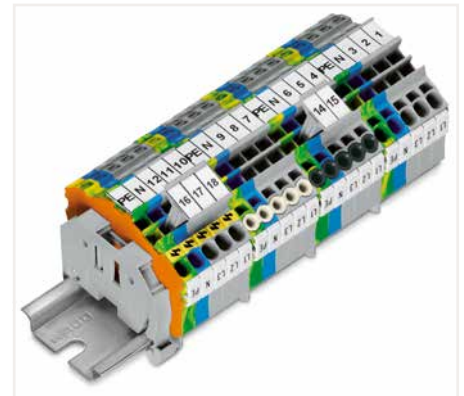



Product features:

- Push-in CAGE CLAMP® connection for all conductor types, with the additional benefit of solid, stranded and fine-stranded conductors with ferrules being simply pushed in
- Vibration-proof, fast, maintenance-free
- 3-conductor through and ground conductor terminal blocks equipped with a dual jumper slot
- 4-conductor terminal blocks permit potential multiplication – no additional jumpers or terminal blocks needed
- 3- and 4-conductor terminal blocks have the same dimensions.
- An end plate must be applied when changing from a 3-conductor terminal block to a 4-conductor terminal block and vice versa.

Through Terminal Block, Ground Conductor Terminal Block, Shield Conductor Terminal Block TOPJOB® S 4 (6) mm²; 2004 Series

1

Technical Data	
0.5 ... 4 (6) mm ² ①	20 ... 10 AWG
800 V/8 kV/3 ②	600 V, 30 A ③
I _N 32 A (41 A)	600 V, 30 A ④
Terminal block width: 6.2 mm / 0.244 inch	
 11 ... 13 mm / 0.43 ... 0.51 inch	

Technical Data	
0.5 ... 4 (6) mm ² ①	20 ... 10 AWG
800 V/8 kV/3 ②	600 V, 30 A ③
I _N 32 A (41 A)	600 V, 30 A ④
Terminal block width: 6.2 mm / 0.244 inch	
 11 ... 13 mm / 0.43 ... 0.51 inch	

Technical Data	
0.5 ... 4 (6) mm ² ①	20 ... 10 AWG
800 V/8 kV/3 ②	600 V, 30 A ③
I _N 32 A (41 A)	600 V, 30 A ④
Terminal block width: 6.2 mm / 0.244 inch	
 11 ... 13 mm / 0.43 ... 0.51 inch	

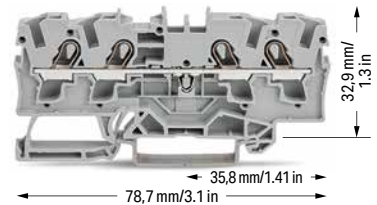

2-conductor through terminal block		
Color	Item No.	Pack. Unit
gray ⑤	2004-1201 ④	50
blue ⑤	2004-1204 ③ ④	50
orange ⑤	2004-1202 ④	50
red ⑤	2004-1203 ④	50
black ⑤	2004-1205 ④	50
yellow ⑤	2004-1206 ④	50

3-conductor through terminal block		
Color	Item No.	Pack. Unit
gray ⑤	2004-1301 ④	50
blue ⑤	2004-1304 ③ ④	50
orange ⑤	2004-1302 ④	50
red ⑤	2004-1303 ④	50
black ⑤	2004-1305 ④	50
yellow ⑤	2004-1306 ④	50

4-conductor through terminal block		
Color	Item No.	Pack. Unit
gray ⑤	2004-1401 ④	50
blue ⑤	2004-1404 ③ ④	50
orange ⑤	2004-1402 ④	50
red ⑤	2004-1403 ④	50
black ⑤	2004-1405 ④	50
yellow ⑤	2004-1406 ④	50

2-conductor ground terminal block		
green-yellow ⑤	2004-1207 ④	50

3-conductor ground terminal block		
green-yellow ⑤	2004-1307 ④	50



4-conductor ground terminal block		
green-yellow ⑤	2004-1407 ④	50



4-conductor shield terminal block		
white ⑤	2004-1408 ④	50



Other terminal blocks with the same profile:		
Diode	2004-1211/1000-401	Page 150



Other terminal blocks with the same profile:		
Diode	2004-1311/1000-401	Page 150



Other terminal blocks with the same profile:		
Diode	2004-1411/1000-401	Page 150



Accessories; item-specific			
End and intermediate plate; 1 mm thick			
	orange	2004-1292	100 (25)
	gray	2004-1291	100 (25)



Accessories; item-specific			
End and intermediate plate; 1 mm thick			
	orange	2004-1392	100 (25)
	gray	2004-1391	100 (25)

Accessories; item-specific			
End and intermediate plate; 1 mm thick			
	orange	2004-1492	100 (25)
	gray	2004-1491	100 (25)

Separator; oversized; 2 mm thick			
	orange	2004-1294	100 (25)
	gray	2004-1293	100 (25)

Separator; oversized; 2 mm thick			
	orange	2004-1394	100 (25)
	gray	2004-1393	100 (25)

Separator; oversized; 2 mm thick			
	orange	2004-1494	100 (25)
	gray	2004-1493	100 (25)

Ex e/Ex i separator; orange; 3 mm thick			
	90 mm	209-190	50 (25)
	120 mm	209-191	50 (25)









Ex e/Ex i separator; orange; 3 mm thick			
	120 mm	209-191	50 (25)









Ex e/Ex i separator; orange; 3 mm thick			
	120 mm	209-191	50 (25)

Accessories; 2004 Series

Appropriate marking systems: WMB/WMB Inline/Marking strips

Insulation stop; 5 pcs/strip; 0.25 ... 0.5 mm ²			
	light gray	2004-171	200 (25)

Push-in type jumper bar; insulated; I _N 32 A; light gray			
	2-way	2004-402	25
	3-way	2004-403	25
	4-way	2004-404	25
	5-way	2004-405	25
	6-way	2004-406	25
	7-way	2004-407	25
	8-way	2004-408	25
	9-way	2004-409	25
	10-way	2004-410	25

Push-in type jumper bar; insulated; I _N 32 A; light gray			
	1 to 3	2004-433	25
	1 to 4	2004-434	25
	1 to 5	2004-435	25
	1 to 6	2004-436	25
	1 to 7	2004-437	25
	1 to 8	2004-438	25
	1 to 9	2004-439	25
	1 to 10	2004-440	25

Insulation stop; 5 pcs/strip; 0.75 ... 1 mm ²			
	dark gray	2004-172	200 (25)

Step-down jumper; insulated; commons 6/4 mm ² (10/12 AWG) to 4/2.5/1.5 mm ² (12/14/16 AWG); I _N 32 A			
	light gray	2006-499	25

Protective warning marker; with black high-voltage symbol; for 5 terminal blocks			
	yellow	2004-115	100 (25)

Star point jumper; insulated; I _N = I _N terminal block; light gray			
	1-3-5	2004-405/011-000	25

Delta jumper; insulated; I _N = I _N terminal block; light gray			
	1-2 3-4 5-6	2004-406/020-000	25

- ❶ Conductor range: 0.5 ... 6 mm² "s+f-st";
Push-in termination: 1.5 ... 6 mm² "s" and 1.5 ... 4 mm² "insulated ferrules; 12 mm"
Depending on the conductor characteristic, a conductor with a smaller cross section can also be inserted via push-in termination.
- ❷ 800 V = rated voltage
8 kV = rated impulse voltage
3 = pollution degree
(see Section 15)
- ❸ Terminal blocks with a blue insulated housing are suitable for Ex i applications.
- ❹ Terminal blocks with an Ex mark are suitable for Ex e II applications.
550 V; 30 A
(see Section 15)

Please observe the application notes:
Separator for Ex e/Ex i applications, see page 63
Step-down jumpers, see page 67
Jumpers, from page 177
Testing accessories, from page 170
Marking, from page 640

Approvals and corresponding ratings, visit www.wago.com

Accessories; 2004 Series

Appropriate marking systems:
WMB/WMB Inline/Marking strips

Modular connector; snaps together; for jumper contact slot

	gray	2004-511	100 (25)
---	------	----------	----------

Spacer module; snaps together; bridges commoned terminal blocks

	gray	2004-549	100 (25)
---	------	----------	----------

Test plug adapter; for 4 mm Ø test plug

	gray	2009-174	100 (25)
---	------	----------	----------

Testing tap; for max. 2.5 mm²

	gray	2009-182	100 (25)
---	------	----------	----------

Marking strip; plain; 11 mm wide; 50 m reel

	white	2009-110	1
---	-------	----------	---

WMB marking card; white; 10 strips with 10 markers/card; 5 ... 5.2 mm stretchable

	plain	793-5501	5
---	-------	----------	---

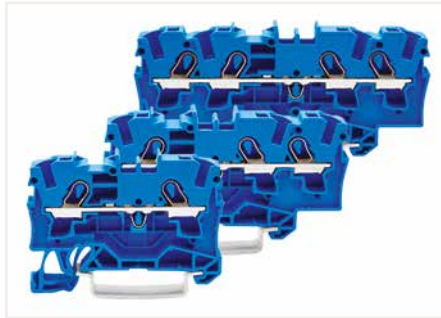

Through terminal blocks with a blue insulated housing are suitable for Ex i applications.



All through and ground conductor terminal blocks are suitable for Ex e II applications.

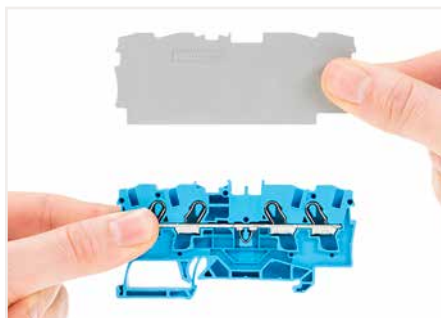

Separator for Ex e/Ex i applications:
An end plate must be applied to the terminal block located directly behind an Ex e/Ex i separator plate.



Ex e II/Ex i terminal strip
Notice:
The movable feet of terminal blocks and separator plates must face the same direction.

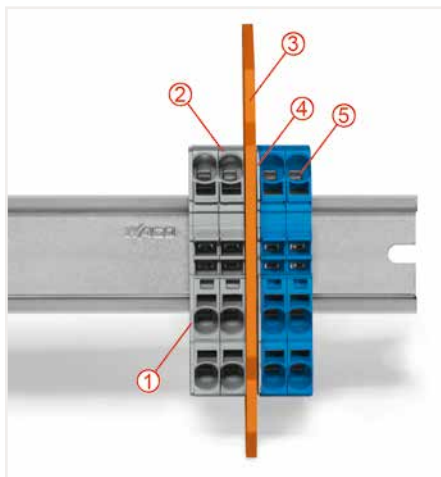

Separator located between Ex e II and Ex i terminal strip
❶ End plate
❷ Ex e II terminal blocks
❸ Separator for Ex e/Ex i applications
❹ End plate
❺ Ex i terminal blocks





Example of marking (rear):
The embossed details on the terminal blocks show the manufacturer's name, the series no., the type of protection Ex e II, the approval no., the approval data and the name of the testing authority.

PUSH-IN CAGE CLAMP®

Through Terminal Block, Ground Conductor Terminal Block, Shield Conductor Terminal Block TOPJOB® S 6 (10) mm²; 2006 Series

1

Technical Data	
0.5 ... 6 (10) mm ² ①	20 ... 8 AWG
800 V/8 kV/3 ②	600 V, 50 A ③
I _N 41 A (57 A)	600 V, 50 A ④
Terminal block width: 7.5 mm / 0.295 inch	
 13 ... 15 mm / 0.51 ... 0.59 inch	

Technical Data	
0.5 ... 6 (10) mm ² ①	20 ... 8 AWG
800 V/8 kV/3 ②	600 V, 50 A ③
I _N 41 A (57 A)	600 V, 50 A ④
Terminal block width: 7.5 mm / 0.295 inch	
 13 ... 15 mm / 0.51 ... 0.59 inch	





2-conductor through terminal block		
Color	Item No.	Pack. Unit
gray ⑤	2006-1201 ④	50
blue ⑤	2006-1204 ③ ④	50
orange ⑤	2006-1202 ④	50



3-conductor through terminal block		
Color	Item No.	Pack. Unit
gray ⑤	2006-1301 ④	25
blue ⑤	2006-1304 ③ ④	25
orange ⑤	2006-1302 ④	25
black ⑤	2006-1305 ④	25



2-conductor ground terminal block		
green-yellow ⑤	2006-1207 ④	50



3-conductor ground terminal block		
green-yellow ⑤	2006-1307 ④	25

2-conductor shield terminal block		
white	2006-1208	50

Accessories; item-specific			
End and intermediate plate; 1 mm thick			
	orange	2006-1292	100 (25)
	gray	2006-1291	100 (25)

Accessories; item-specific			
End and intermediate plate; 1 mm thick			
	orange	2006-1392	100 (25)
	gray	2006-1391	100 (25)





Separator; oversized; 2 mm thick			
	orange	2006-1294	100 (25)
	gray	2006-1293	100 (25)

Separator; oversized; 2 mm thick			
	orange	2006-1394	100 (25)
	gray	2006-1393	100 (25)



Accessories; 2006 Series
Appropriate marking systems: WMB/WMB Inline/Marking strips

Ex e/Ex i separator; orange; 3 mm thick			
	120 mm	209-191	50 (25)

Protective warning marker; with black high-voltage symbol; for 5 terminal blocks			
	yellow	2006-115	100 (25)

Push-in type jumper bar; insulated; I _N 41 A; light gray			
	2-way	2006-402	25
	3-way	2006-403	25
	4-way	2006-404	25
	5-way	2006-405	25

Lockout cap; for conductor entry and operating slot			
	gray	2006-191	25

Push-in type jumper bar; insulated; I _N 41 A; light gray			
	1 to 3	2006-433	25
	1 to 4	2006-434	25
	1 to 5	2006-435	25

Modular connector; snaps together; for jumper contact slot			
	gray	2006-511	50 (25)

Star point jumper; insulated; I _N = I _N terminal block; light gray			
	1-3-5	2006-405/011-000	25

Test plug adapter; for 4 mm Ø test plug			
	gray	2009-174	100 (25)

Step-down jumper; insulated; commons 6/4 mm ² (10/12 AWG) to 4/2.5/1.5 mm ² (12/14/16 AWG); I _N 32 A			
	light gray	2006-499	25

Marking strip; plain; 11 mm wide; 50 m reel			
	white	2009-110	1

① Conductor range: 0.5 ... 10 mm² "s+f-st"; Push-in termination: 2.5 ... 10 mm² "s" and 2.5 ... 6 mm² "insulated ferrules; 12 mm" Depending on the conductor characteristic, a conductor with a smaller cross section can also be inserted via push-in termination.

② 800 V = rated voltage
8 kV = rated impulse voltage
3 = pollution degree (see Section 15)

③ Terminal blocks with a blue insulated housing are suitable for Ex i applications.

④ Terminal blocks with an Ex mark are suitable for Ex e II applications.
550 V; 38 A; for 2-conductor terminal blocks
550 V; 36 A; for 3-conductor terminal blocks
33 A jumper (see Section 15)

Please observe the application notes:
Separator for Ex e/Ex i applications, see page 63
Step-down jumpers, see page 67
Jumpers, from page 177
Testing accessories, from page 170
Marking, from page 640

Approvals and corresponding ratings, visit www.wago.com



Cover (2006-191) seals unused conductor entry.

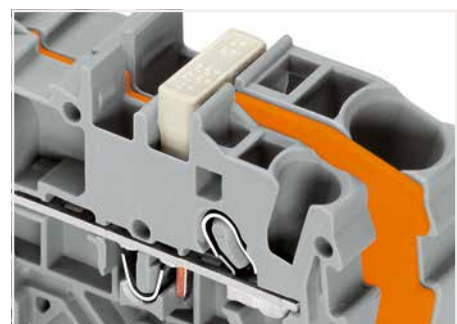

Commoning with step-down jumpers.

Through Terminal Block, Ground Conductor Terminal Block, Shield Conductor Terminal Block TOPJOB® S 10 (16) mm²; 2010 Series

Technical Data

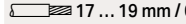
0.5 ... 10 (16) mm ² ①	20 ... 6 AWG
800 V/8 kV/3 ②	600 V, 65 A ^{III}
I _N 57 A (76 A)	600 V, 65 A ^{II}
Terminal block width: 10 mm / 0.394 inch	
 17 ... 19 mm / 0.67 ... 0.75 inch	

Technical Data

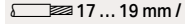
0.5 ... 10 (16) mm ² ①	20 ... 6 AWG
800 V/8 kV/3 ②	600 V, 65 A ^{III}
I _N 57 A (76 A)	600 V, 65 A ^{II}
Terminal block width: 10 mm / 0.394 inch	
 17 ... 19 mm / 0.67 ... 0.75 inch	

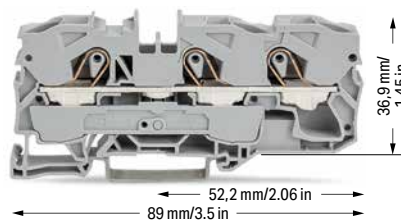
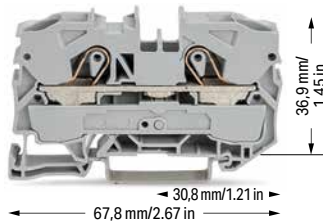

2-conductor through terminal block

Color	Item No.	Pack. Unit
gray ③	2010-1201 ④	25
blue ③	2010-1204 ③ ④	25
orange ③	2010-1202 ④	25
black ③	2010-1205 ④	25
dunkelgrau-gelb ③	2010-1201/000-053 ④	25

3-conductor through terminal block

Color	Item No.	Pack. Unit
gray ③	2010-1301 ④	25
blue ③	2010-1304 ③ ④	25
orange ③	2010-1302 ④	25
black ③	2010-1305 ④	25
dunkelgrau-gelb ③	2010-1301/000-053 ④	25

2-conductor ground terminal block

green-yellow ③	2010-1207 ④	25
----------------	-------------	----

3-conductor ground terminal block

green-yellow ③	2010-1307 ④	25
----------------	-------------	----

2-conductor shield terminal block

white	2010-1208	25
-------	-----------	----

Accessories; item-specific

End and intermediate plate; 1 mm thick

	orange	2010-1292	100 (25)
	gray	2010-1291	100 (25)

Accessories; item-specific

End and intermediate plate; 1 mm thick

	orange	2010-1392	100 (25)
	gray	2010-1391	100 (25)

Accessories; 2010 Series

Appropriate marking systems: WMB/WMB Inline/Marking strips

Ex e/Ex i separator; orange; 3 mm thick

	120 mm	209-191	50 (25)
---	--------	---------	---------

Finger guard; touch-proof cover protects unused conductor entries

	yellow	2010-100	100 (25)
---	--------	----------	----------

Push-in type jumper bar; insulated; I_N 57 A; light gray

	2-way	2010-402	25
	3-way	2010-403	25
	4-way	2010-404	25
	5-way	2010-405	25

Modular connector; snaps together; for jumper contact slot

	gray	2010-511	50 (25)
---	------	----------	---------

Push-in type jumper bar; insulated; I_N 57 A; light gray

	1 to 3	2010-433	25
	1 to 4	2010-434	25
	1 to 5	2010-435	25

Test plug adapter; for 4 mm Ø test plug

	gray	2009-174	100 (25)
---	------	----------	----------

Star point jumper; insulated; I_N = I_N terminal block; light gray

	1-3-5	2010-405/011-000	25
---	-------	------------------	----

Marking strip; plain; 11 mm wide; 50 m reel

	white	2009-110	1
---	-------	----------	---

Step-down jumper; insulated; commons 16/10 mm² (8/10 AWG) to 10/6/4/2.5 mm² (8/10/12/14 AWG); I_N 57 A

	light gray	2016-499	25
---	------------	----------	----

WMB marking card; white; 10 strips with 10 markers/card; 5 ... 5.2 mm stretchable

	plain	793-5501	5
---	-------	----------	---

Protective warning marker; with black high-voltage symbol; for 5 terminal blocks

	yellow	2010-115	100 (25)
---	--------	----------	----------

① Conductor range: 0.5 ... 16 mm² "s+f-st"; Push-in termination: 4 ... 16 mm² "s" and 4 ... 10 mm² "insulated ferrules; 18 mm"
Depending on the conductor characteristic, a conductor with a smaller cross section can also be inserted via push-in termination.

② 800 V = rated voltage
8 kV = rated impulse voltage
3 = pollution degree (see Section 15)

③ Terminal blocks with a blue insulated housing are suitable for Ex i applications.

④ Terminal blocks with an Ex mark are suitable for Ex e II applications.
550 V; 51 A; for 2-conductor terminal blocks
550 V; 50 A; for 3-conductor terminal blocks (see Section 15)

Please observe the application notes:

Separator for Ex e/Ex i applications, see page 63

Step-down jumpers, see page 67

Jumpers, from page 177

Testing accessories, from page 170

Marking, from page 640

Approvals and corresponding ratings, visit www.wago.com

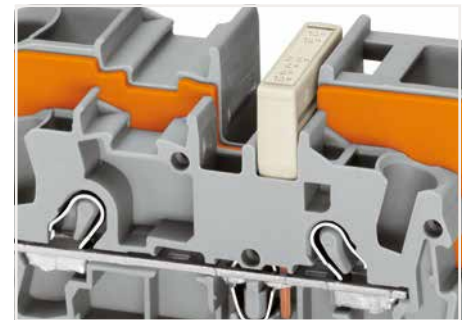

Commoning with step-down jumpers.

PUSH-IN CAGE CLAMP®

Through Terminal Block, Ground Conductor Terminal Block, Shield Conductor Terminal Block

TOPJOB® S

16 (25 "f-st") mm²; 2016 Series

1

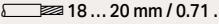
Technical Data	
0.5 ... 16 (25 "f-st") mm ² ①	20 ... 4 AWG
800 V/8 kV/3 ②	600 V, 85 A ③
I _N 76 A (90 A)	600 V, 80 A ④
Terminal block width: 12 mm / 0.472 inch	
 18 ... 20 mm / 0.71 ... 0.79 inch	

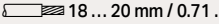
Technical Data	
0.5 ... 16 (25 "f-st") mm ² ①	20 ... 4 AWG
800 V/8 kV/3 ②	600 V, 85 A ③
I _N 76 A (90 A)	600 V, 80 A ④
Terminal block width: 12 mm / 0.472 inch	
 18 ... 20 mm / 0.71 ... 0.79 inch	

① Conductor range: 0.5 ... 16 mm² "s+f-st", 25 mm² "f-st";
Push-in termination: 6 ... 16 mm² "s" and 6 ... 16 mm² "insulated ferrules; 18 mm"
Depending on the conductor characteristic, a conductor with a smaller cross section can also be inserted via push-in termination.

② 800 V = rated voltage
8 kV = rated impulse voltage
3 = pollution degree
(see Section 15)

③ Terminal blocks with a blue insulated housing are suitable for Ex i applications.

④ Terminal blocks with an Ex mark are suitable for Ex e II applications.
550 V; 70 A; for 2-conductor terminal blocks
550 V; 67 A; for 3-conductor terminal blocks
65 A jumper
(see Section 15)

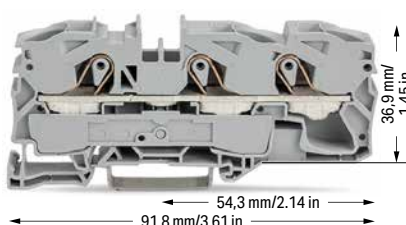
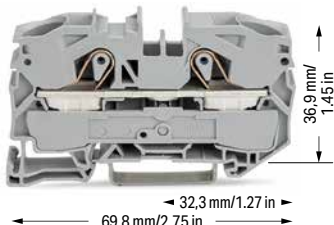

2-conductor through terminal block		
Color	Item No.	Pack. Unit
gray ⑤	2016-1201 ④	20
blue ⑤	2016-1204 ③ ④	20
orange ⑤	2016-1202 ④	20
red ⑤	2016-1203 ④	20

3-conductor through terminal block		
Color	Item No.	Pack. Unit
gray ⑤	2016-1301 ④	20
blue ⑤	2016-1304 ③ ④	20
orange ⑤	2016-1302 ④	20
red ⑤	2016-1303 ④	20
black ⑤	2016-1305 ④	20
yellow ⑤	2016-1306 ④	20

Please observe the application notes:
Separator for Ex e/Ex i applications, see page 63
Step-down jumpers, see page 67
Jumpers, from page 177
Testing accessories, from page 171
Marking, from page 640

Approvals and corresponding ratings, visit www.wago.com



2-conductor ground terminal block		
15 mm high DIN-35 rails shall be used for a current load higher than 76 A!		
green-yellow ⑤	2016-1207 ④	20

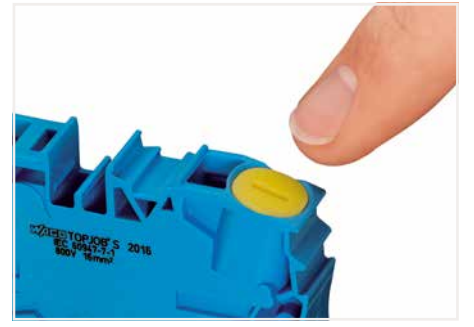

3-conductor ground terminal block		
15 mm high DIN-35 rails shall be used for a current load higher than 76 A!		
green-yellow ⑤	2016-1307 ④	20

2-conductor shield terminal block		
15 mm high DIN-35 rails shall be used for a current load higher than 76 A!		
white	2016-1208	20





Finger guard seals an unused conductor entry.





Accessories; item-specific			
End and intermediate plate; 1 mm thick			
	orange	2016-1292	100 (25)
	gray	2016-1291	100 (25)

Accessories; item-specific			
End and intermediate plate; 1 mm thick			
	orange	2016-1392	100 (25)
	gray	2016-1391	100 (25)



Accessories; 2016 Series Appropriate marking systems: WMB/WMB Inline/Marking strips

Ex e/Ex i separator; orange; 3 mm thick			
	120 mm	209-191	50 (25)

Protective warning marker; with black high-voltage symbol; for 5 terminal blocks			
	yellow	2016-115	100 (25)

Push-in type jumper bar; insulated; I _N 76 A; light gray			
	2-way	2016-402	25
	3-way	2016-403	25
	4-way	2016-404	25
	5-way	2016-405	25

Finger guard; touch-proof cover protects unused conductor entries			
	yellow	2016-100	100 (25)

Push-in type jumper bar; insulated; I _N 76 A; light gray			
	1 to 3	2016-433	25
	1 to 4	2016-434	25
	1 to 5	2016-435	25

Modular connector; snaps together; for jumper contact slot			
	gray	2016-511	50 (25)

Star point jumper; insulated; I _N = I _N terminal block; light gray			
	1-3-5	2016-405/011-000	25

Test plug adapter; for 4 mm Ø test plug			
	gray	2009-174	100 (25)

Step-down jumper; insulated; commons 16/10 mm ² (8/10 AWG) to 10/6/4/2.5 mm ² (8/10/12/14 AWG); I _N 57 A			
	light gray	2016-499	25

Step-Down Jumpers TOPJOB® S Installation



Step-down jumpers (2006-499 and 2016-499)

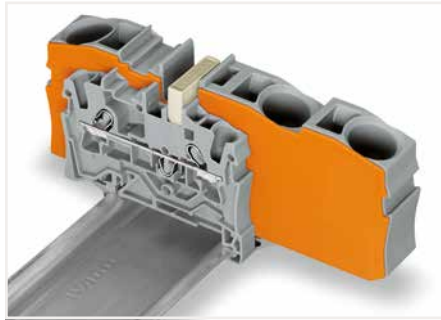

Step-down jumpers connect common terminal blocks of different sizes, without losing a conductor clamping point. This can be beneficial on long conductor runs where voltage drop can be a problem. A large conductor can be easily connected to smaller conductors at the distribution point. Commoning may be made in either direction using the special thin end plate to cover the open side. Additional through terminal blocks having a smaller cross-section may be commoned using push-in type jumper bars.



Using step-down jumpers, an end plate must be inserted between the terminal blocks to be commoned.

1



Step-down jumper (2006-499) commons 6/4 mm² (10/12 AWG) terminal blocks (2006/2004 Series) with 4/2.5/1.5 mm² (AWG 12/14/16) terminal blocks (2004/2002/2001 Series).

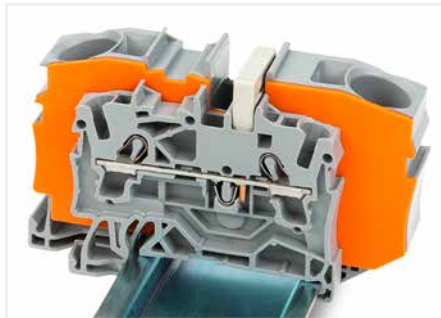

Step-down jumper (2016-499) commons 16/10 mm² (16/8 AWG) terminal blocks (2016/2010 Series) with 10/6/4/2.5 mm² (8/10/12/14 AWG) terminal blocks (2010/2006/2004/2002 Series).



Stepping down via push-in type jumper bar: Commoning via open terminal side with end plate allows jumpering over two cross-section sizes for 16 mm² (6 AWG) and 10 mm² (8 AWG) and one cross-section size for 6/4/2.5 mm² (10/12/14 AWG). An example: from 16 mm² (6 AWG) to 6 mm² (10 AWG) (see illustration above) or from 10 mm² (8 AWG) to 4 mm² (12 AWG).

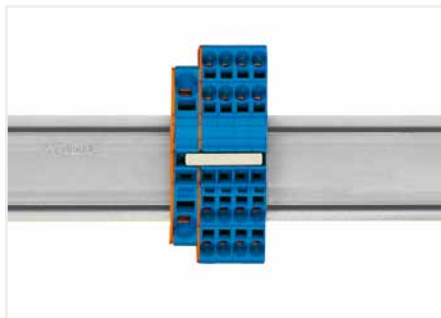

Stepping down via push-in type jumper bar: Commoning via closed terminal side with end plate allows jumpering over two cross-section sizes, e.g., from 16 mm² (6 AWG) to 6 mm² (10 AWG) or from 6 mm² (10 AWG) to 2.5 mm² (14 AWG) (see illustration above).



Note: The total current of the outgoing circuits must not exceed the nominal current of the step-down jumper/push-in type jumper bar.

Electrical Interconnection Set and Rail-Mount Terminal Block Set 821 Series



Electrical interconnection set; L-BOXX® 102; 221 Series & TOPJOB® S with Lever

	Item No.	Pack. Unit
	821-153	1

Contents

Qty.	Item No.	Description
		COMPACT Splicing Connectors
100	221-412	COMPACT splicing connector; 2 wires; 0.14 ... 4 mm ² ; with levers; transparent
50	221-413	COMPACT splicing connector; 3 wires; 0.14 ... 4 mm ² ; with levers; transparent
25	221-415	COMPACT splicing connector; 5 wires; 0.14 ... 4 mm ² ; with levers; transparent
50	221-612	COMPACT splicing connector; 2 wires; 0.5 ... 6 mm ² ; with levers; transparent
30	221-613	COMPACT splicing connector; 3 wires; 0.5 ... 6 mm ² ; with levers; transparent
15	221-615	COMPACT splicing connector; 5 wires; 0.5 ... 6 mm ² ; with levers; transparent
		TOPJOB® S Rail-Mount Terminal Blocks
60	2102-1201	2-conductor through terminal block; with lever and Push-in CAGE CLAMP®; 0.25 ... 2.5 (4) mm ² ; gray
12	2106-1201	2-conductor through terminal block; with lever and Push-in CAGE CLAMP®; 0.5 ... 6 (10) mm ² ; gray
		Accessories
1	210-110	Felt-tip pen; smudge-proof
5	221-500	Mounting carrier; 221 Series – 4 mm ² ; for DIN-35 rail/screw mounting; orange
3	221-510	Mounting carrier; 221 Series – 6 mm ² ; for DIN-35 rail/screw mounting; orange
10	249-116	Screwless end stop; for DIN-35 rail; 6 mm wide; gray
2	793-5501	WMB marker card; plain
2	793-5566	WMB marker card; marking 1 ... 50
25	2002-400	Adjacent jumper for continuous commoning; insulated; 2-way; Nominal current: 25 A; light gray
25	2006-402	Push-in type jumper bar; insulated; 2-way; Nominal current: 41 A; light gray
1	2009-310	Operating tool; 3.5 x 0.5 mm and 5.5 x 0.8 mm blades
15	2102-1292	End and intermediate plate; for 2-conductor terminal blocks; orange
5	2106-1292	End and intermediate plate; for 2-conductor terminal blocks; orange

Rail-mount terminal block set; L-BOXX® 102; 20xx, 21xx, 22xx Series

	Item No.	Pack. Unit
	821-154	1

Contents

Qty.	Item No.	Description
		TOPJOB® S Rail-Mount Terminal Blocks
10	2002-1301	3-conductor through terminal block; with Push-in CAGE CLAMP®; 0.25 ... 2.5 (4) mm ² ; gray
8	2004-1201	2-conductor through terminal block; with Push-in CAGE CLAMP®; 0.5 ... 4 (6) mm ² ; gray
20	2102-1201	2-conductor through terminal block; with lever and Push-in CAGE CLAMP®; 0.25 ... 2.5 (4) mm ² ; gray
6	2102-5301	3-conductor through terminal block; with lever and push-button; 0.25 ... 2.5 (4) mm ² ; gray
2	2102-5304	3-conductor through terminal block; with lever and push-button; 0.25 ... 2.5 (4) mm ² ; blue
2	2102-5307	3-conductor ground terminal block; with lever and push-button; 0.25 ... 2.5 (4) mm ² ; green-yellow
6	2106-5301	3-conductor through terminal block; with lever and push-button; 0.5 ... 6 (10) mm ² ; gray
2	2106-5304	3-conductor through terminal block; with lever and push-button; 0.5 ... 6 (10) mm ² ; blue
2	2106-5307	3-conductor ground terminal block; with lever and push-button; 0.5 ... 6 (10) mm ² ; green-yellow
6	2116-5301	3-conductor through terminal block; with lever and push-button; 0.5 ... 16 (25) mm ² ; gray
2	2116-5304	3-conductor through terminal block; with lever and push-button; 0.5 ... 16 (25) mm ² ; blue
2	2116-5307	3-conductor ground terminal block; with lever and push-button; 0.5 ... 16 (25) mm ² ; green-yellow
25	2200-1401	4-conductor through terminal block; with push-button; 0.14 ... 1 (1.5) mm ² ; gray
10	2202-1301	3-conductor through terminal block; with push-button; 0.25 ... 2.5 (4) mm ² ; gray
8	2204-1201	2-conductor through terminal block; with push-button; 0.5 ... 4 (6) mm ² ; gray
6	2210-1201	2-conductor through terminal block; with push-button; 0.5 ... 10 (16) mm ² ; gray
2	2210-1204	2-conductor through terminal block; with push-button; 0.5 ... 10 (16) mm ² ; blue
2	2210-1207	2-conductor ground terminal block; with push-button; 0.5 ... 10 (16) mm ² ; green-yellow

Contents 821-154 (continued)

Qty.	Item No.	Description
		Accessories
10	249-116	Screwless end stop; for DIN-35 rail; 6 mm wide; gray
25	2000-402	Push-in type jumper bar; insulated; 2-way; Nominal current: 14 A; light gray
10	2000-1491	End and intermediate plate; for 4-conductor terminal blocks; gray
25	2002-400	Adjacent jumper for continuous commoning; insulated; 2-way; Nominal current: 25 A; light gray
25	2002-402	Push-in type jumper bar; insulated; 2-way; Nominal current: 25 A; light gray
10	2002-1391	End and intermediate plate; for 3-conductor terminal blocks; gray
10	2004-402	Push-in type jumper bar; insulated; 2-way; Nominal current: 32 A; light gray
10	2004-1291	End and intermediate plate; for 2-conductor terminal blocks; gray
10	2006-402	Push-in type jumper bar; insulated; 2-way; Nominal current: 41 A; light gray
5	2010-402	Push-in type jumper bar; insulated; 2-way; Nominal current: 57 A; light gray
5	2010-1291	End and intermediate plate; for 2-conductor terminal blocks; gray
10	2016-402	Push-in type jumper bar; insulated; 2-way; Nominal current: 76 A; light gray
10	2102-1291	End and intermediate plate; for 2-conductor terminal blocks; gray
5	2102-1391	End and intermediate plate; for 3-conductor terminal blocks; gray
5	2106-1391	End and intermediate plate; for 3-conductor terminal blocks; gray
5	2116-1391	End and intermediate plate; for 3-conductor terminal blocks; gray

Rail-mount terminal block set; L-BOXX® 102; 2002, 2006, 2016 Series

	Item No.	Pack. Unit
	821-155	1

Contents

Qty.	Item No.	Description
		TOPJOB® S Rail-Mount Terminal Blocks
75	2002-1201	2-conductor through terminal block; 0.25 ... 2.5 (4) mm ² ; gray
25	2002-1204	2-conductor through terminal block; 0.25 ... 2.5 (4) mm ² ; blue
25	2002-1207	2-conductor ground terminal block; 0.25 ... 2.5 (4) mm ² ; green-yellow
9	2006-1201	2-conductor through terminal block; 0.5 ... 6 (10) mm ² ; gray
3	2006-1204	2-conductor through terminal block; 0.5 ... 6 (10) mm ² ; blue
3	2006-1207	2-conductor ground terminal block; 0.5 ... 6 (10) mm ² ; green-yellow
12	2016-1201	2-conductor through terminal block; 0.5 ... 16 (25) mm ² ; gray
6	2016-1204	2-conductor through terminal block; 0.5 ... 16 (25) mm ² ; blue
6	2016-1207	2-conductor ground terminal block; 0.5 ... 16 (25) mm ² ; green-yellow
		Accessories
1	210-110	Felt-tip pen; smudge-proof
1	210-722	Operating tool set; with a partially insulated shaft
5	249-119	Height-adjustable group marker carrier
10	249-117	Screwless end stop; for DIN-35 rail; 10 mm wide; gray
2	793-5501	WMB marker card; plain
2	793-5566	WMB marker card; marking 1 ... 50
1	793-5472	WMB marker card; Marking L1, L2, L3, N, PE
25	2002-400	Adjacent jumper for continuous commoning; insulated; 2-way; Nominal current: 25 A; light gray
25	2002-1292	End and intermediate plate; for 2-conductor terminal blocks; orange
25	2006-402	Push-in type jumper bar; insulated; 2-way; Nominal current: 41 A; light gray
10	2006-1292	End and intermediate plate; for 2-conductor terminal blocks; orange
1	2009-110	Marking strip; white; 1 m long
5	2009-182	Testing tap; for max. 2.5 mm ²
1	2009-310	Operating tool; 3.5 x 0.5 mm and 5.5 x 0.8 mm blades
25	2016-402	Push-in type jumper bar; insulated; 2-way; Nominal current: 76 A; light gray
10	2016-1292	End and intermediate plate; for 2-conductor terminal blocks; orange

Double-Deck Terminal Block TOPJOB® S; with Push-Button; with Vertical Conductor Entry 2.5 (4) mm²; 2202 Series

1

Technical Data

0.25 ... 2.5 (4) mm ² ①	22 ... 12 AWG
800 V/8 kV/3 ②	600 V, 20 A ③
I _N 24 A	600 V, 24 A ④
Terminal block width: 5.2 mm / 0.205 inch	
 10 ... 12 mm / 0.39 ... 0.47 inch	

Technical Data

0.25 ... 2.5 (4) mm ² ①	22 ... 12 AWG
800 V/8 kV/3 ②	600 V, 20 A ③
I _N 24 A	600 V, 24 A ④
Terminal block width: 5.2 mm / 0.205 inch	
 10 ... 12 mm / 0.39 ... 0.47 inch	

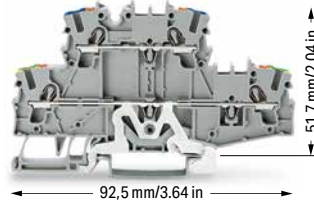
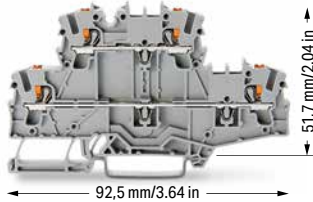

Double-deck terminal block; with push-button; through/through terminal block; with vertical conductor entry; without marker carrier; gray

	Item No.	Pack. Unit
○ L/L ④	2202-2701 ④	50
○ N/L ④	2202-2702 ④	50
○ L/N ④	2202-2703 ④	50

Double-deck terminal block; with push-button; ground conductor/through terminal block; with vertical conductor entry; without marker carrier; gray

	Item No.	Pack. Unit
○ PE/N ④	2202-2717 ④	50
○ PE/L ④	2202-2727 ④	50

Double-deck terminal block; with push-button; through/through terminal block; with vertical conductor entry; without marker carrier; blue

● N/N ④	2202-2704 ③ ④	50
---------	---------------	----

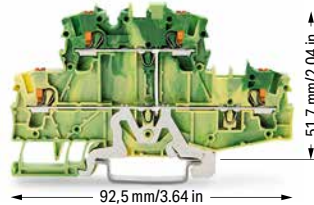
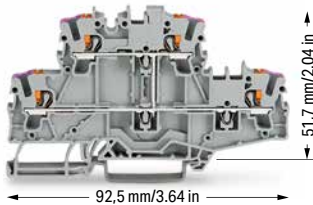

Double-deck terminal block; with push-button; 4-conductor through terminal block; with vertical conductor entry; without marker carrier; Internally commoned; violet conductor entry; gray

	Item No.	Pack. Unit
○ L ④	2202-2708 ④	50

Double-deck terminal block; with push-button; 4-conductor ground terminal block; with vertical conductor entry; without marker carrier; Internally commoned; green-yellow

	Item No.	Pack. Unit
● PE ④	2202-2707 ④	50

Double-deck terminal block; with push-button; 4-conductor through terminal block; with vertical conductor entry; without marker carrier; Internally commoned; violet conductor entry; blue

● N ④	2202-2709 ③ ④	50
-------	---------------	----

① Conductor range: 0.25 ... 4 mm² "s+f-st"
Push-in termination: 1 ... 4 mm² "s" and 1 ... 2.5 mm² "insulated ferrules, 12 mm"
Depending on the conductor characteristic, a conductor with a smaller cross section can also be inserted via push-in termination.

② 800 V = rated voltage
8 kV = rated impulse voltage
3 = pollution degree (see Section 15)

③ Terminal blocks with a blue insulated housing are suitable for Ex i applications.

④ Terminal blocks with an Ex mark are suitable for Ex e II applications.
550 V; 17.5 A
17 A jumper (see Section 15)

Please observe the application notes:
Jumpers, from page 174
Testing accessories, page 173
Marking, from page 640

Approvals and corresponding ratings, visit www.wago.com

Accessories; 2202 Series

Appropriate marking systems:
WMB/WMB Inline/Marking strips

End and intermediate plate; 0.8 mm thick

	orange	2002-2792	100 (25)
	gray	2002-2791	100 (25)

Ex e/Ex i separator; orange; 3 mm thick

	125.5 mm	209-192	50 (25)
---	----------	---------	---------

Insulation stop; 5 pcs/strip; 0.25 ... 0.5 mm²

	light gray	2002-171	200 (25)
---	------------	----------	----------

Insulation stop; 5 pcs/strip; 0.75 ... 1 mm²

	dark gray	2002-172	200 (25)
---	-----------	----------	----------

Push-in type jumper bar; insulated; I_N 25 A; light gray

	2-way	2002-402	25
	3-way	2002-403	25
	4-way	2002-404	25
	5-way	2002-405	25
	6-way	2002-406	25
	7-way	2002-407	25
	8-way	2002-408	25
	9-way	2002-409	25
	10-way	2002-410	25

Push-in type jumper bar; insulated; I_N 25 A; light gray

	1 to 3	2002-433	25
	1 to 4	2002-434	25
	1 to 5	2002-435	25
	1 to 6	2002-436	25
	1 to 7	2002-437	25
	1 to 8	2002-438	25
	1 to 9	2002-439	25
	1 to 10	2002-440	25

Double-deck vertical jumper; insulated; I_N 24 A

	light gray	2002-492	100 (25)
	orange	2002-492/000-012	100 (25)

Double-deck marker carrier; pivoting

	gray	2002-121	50 (25)
---	------	----------	---------

Double-Deck Terminal Block TOPJOB® S

1 (1.5) mm²; 2000 Series

1

Technical Data	
0.14 ... 1 (1.5) mm ² ①	24 ... 16 AWG
500 V/6 kV/3 ②	600 V, 10 A ③
I _N 13.5 A (16 A)	
Terminal block width: 3.5 mm / 0.138 inch	
9 ... 11 mm / 0.35 ... 0.43 inch	

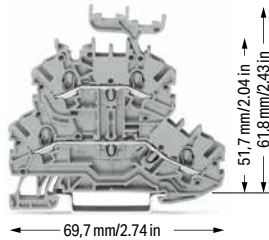

Double-deck terminal block; through/through terminal block; with marker carrier; gray

	Item No.	Pack. Unit
○ L/L ④	2000-2231 ④	50
○ N/L ④	2000-2232 ④	50
○ L/N ④	2000-2233 ④	50

Double-deck terminal block; through/through terminal block; without marker carrier; gray

○ L/L ④	2000-2201 ④	50
○ N/L ④	2000-2202 ④	50
○ L/N ④	2000-2203 ④	50

Technical Data	
0.14 ... 1 (1.5) mm ² ①	24 ... 16 AWG
500 V/6 kV/3 ②	600 V, 10 A ③
I _N 13.5 A (16 A)	
Terminal block width: 3.5 mm / 0.138 inch	
9 ... 11 mm / 0.35 ... 0.43 inch	

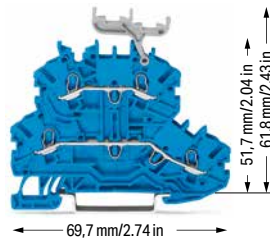

Double-deck terminal block; through/through terminal block; with marker carrier; blue

● N/N ④	2000-2234 ③ ④	50
---------	---------------	----

Double-deck terminal block; through/through terminal block; without marker carrier; blue

● N/N ④	2000-2204 ③ ④	50
---------	---------------	----

Technical Data	
0.14 ... 1 (1.5) mm ² ①	24 ... 16 AWG
500 V/6 kV/3 ②	600 V, 10 A ③
I _N 13.5 A (16 A)	
Terminal block width: 3.5 mm / 0.138 inch	
9 ... 11 mm / 0.35 ... 0.43 inch	

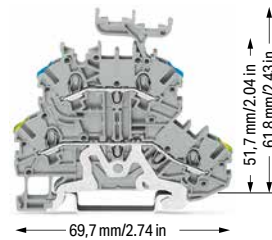

Double-deck terminal block; ground conductor/through terminal block; with marker carrier; blue

○ PE/N ④	2000-2247 ④	50
○ PE/L ④	2000-2257 ④	50

Double-deck terminal block; ground conductor/through terminal block; without marker carrier; gray

○ PE/N ④	2000-2217 ④	50
○ PE/L ④	2000-2227 ④	50

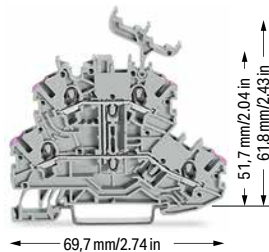

Double-deck terminal block; 4-conductor through terminal block; with marker carrier; internally commuted; violet conductor entry; gray

○ L ④	2000-2238 ④	50
-------	-------------	----

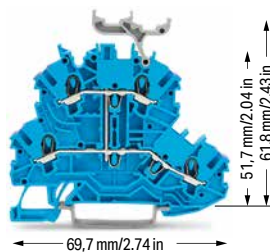

Double-deck terminal block; 4-conductor through terminal block; with marker carrier; internally commuted; violet conductor entry; blue

● N ④	2000-2239 ③ ④	50
-------	---------------	----

Double-deck terminal block; 4-conductor through terminal block; without marker carrier; internally commuted; violet conductor entry; gray

○ L ④	2000-2208 ④	50
-------	-------------	----

Double-deck terminal block; 4-conductor through terminal block; without marker carrier; internally commuted; violet conductor entry; blue

● N ④	2000-2209 ③ ④	50
-------	---------------	----

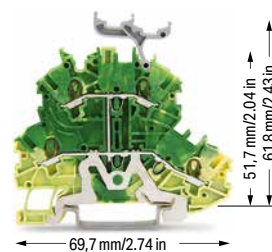

Double-deck terminal block; 4-conductor ground terminal block; with marker carrier; internally commuted; green-yellow

● PE ④	2000-2237 ④	50
--------	-------------	----

Double-deck terminal block; 4-conductor ground terminal block; without marker carrier; internally commuted; green-yellow

● PE ④	2000-2207 ④	50
--------	-------------	----

Technical Data

0.14 ... 1 (1.5) mm² ① | 24 ... 16 AWG

500 V/6 kV/3 ② | 600 V, 10 A ③

I_N 13.5 A (16 A)

Terminal block width: 3.5 mm / 0.138 inch

9 ... 11 mm / 0.35 ... 0.43 inch

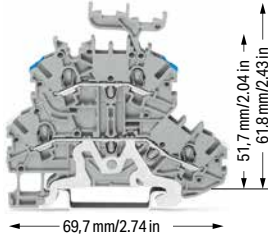

Double-deck terminal block; shield/through terminal block; with marker carrier; gray

	Item No.	Pack. Unit
○ Shield/N	2000-2248	50
○ Shield/L	2000-2258	50

Double-deck terminal block; shield/through terminal block; without marker carrier; gray

○ Shield/N	2000-2218	50
○ Shield/L	2000-2228	50

① Conductor range: 0.14 ... 1.5 mm² "s+f-st"; Push-in termination: 0.5 ... 1.5 mm² "s" and 0.5 ... 0.75 mm² "insulated ferrules; 10 mm" Depending on the conductor characteristic, a conductor with a smaller cross section can also be inserted via push-in termination.

② 800 V = rated voltage
8 kV = rated impulse voltage
3 = pollution degree (see Section 15)

③ Terminal blocks with a blue insulated housing are suitable for Ex i applications.

④ Terminal blocks with an Ex mark are suitable for Ex e II applications.
350 V; 13 A
12 A jumper (see Section 15)

Please observe the application notes:
Jumpers, from page 174
Testing accessories, page 173
Marking, from page 640

Approvals and corresponding ratings, visit www.wago.com

Accessories; 2000 Series

Appropriate marking systems:
WMB/WMB Inline/Marking strips

End and intermediate plate; 0.7 mm thick

orange	2000-2292	25
gray	2000-2291	25

Ex e/Ex i separator; orange; 3 mm thick

125.5 mm	209-192	50 (25)
----------	---------	---------

Push-in type jumper bar; insulated; I_N 14 A; light gray

2-way	2000-402	25
3-way	2000-403	25
4-way	2000-404	25
5-way	2000-405	25
6-way	2000-406	25
7-way	2000-407	25
8-way	2000-408	25
9-way	2000-409	25
10-way	2000-410	25

Push-in type jumper bar; insulated; I_N 14 A; light gray

1 to 3	2000-433	25
1 to 4	2000-434	25
1 to 5	2000-435	25
1 to 6	2000-436	25
1 to 7	2000-437	25
1 to 8	2000-438	25
1 to 9	2000-439	25
1 to 10	2000-440	25

Double-deck vertical jumper; insulated; I_N 13.5 A

light gray	2000-492	100 (25)
------------	----------	----------

Protective warning marker; with black high-voltage symbol; for 5 terminal blocks

yellow	2000-115	100 (25)
--------	----------	----------

Test plug adapter; for 4 mm Ø test plug

gray	2009-174	100 (25)
------	----------	----------

Accessories; 2000 Series

Appropriate marking systems:
WMB/WMB Inline/Marking strips

Testing tap; for max. 2.5 mm²

gray	2009-182	100 (25)
------	----------	----------

Marking strip; plain; 11 mm wide; 50 m reel

white	2009-110	1
-------	----------	---

WMB Inline; plain; 2,300 WMB markers (3.5 mm)/reel

white	2009-113	1
-------	----------	---

WMB marking card; white; 10 strips with 10 markers/card; for 3.5 mm terminal block width

plain	793-3501	5
-------	----------	---

Double-deck marker carrier; pivoting

gray	2000-121	50 (25)
------	----------	---------



Double-deck terminal blocks:

A double-deck marker carrier (2000-121) can be retrofitted to double-deck terminal blocks without a marker carrier.

Double-Deck Terminal Block TOPJOB® S; with End Plate; 800 V 1 (1.5) mm²; 2000 Series

1

Technical Data	
0.14 ... 1 (1.5) mm ² ①	24 ... 16 AWG
800 V/8 kV/3 ②	600 V, 10 A ③
I _N 13.5 A (16 A)	
Terminal block width: 4.2 mm / 0.165 inch	
9 ... 11 mm / 0.35 ... 0.43 inch	

Technical Data	
0.14 ... 1 (1.5) mm ² ①	24 ... 16 AWG
800 V/8 kV/3 ②	600 V, 10 A ③
I _N 13.5 A (16 A)	
Terminal block width: 4.2 mm / 0.165 inch	
9 ... 11 mm / 0.35 ... 0.43 inch	

Technical Data	
0.14 ... 1 (1.5) mm ² ①	24 ... 16 AWG
800 V/8 kV/3 ②	600 V, 10 A ③
I _N 13.5 A (16 A)	
Terminal block width: 4.2 mm / 0.165 inch	
9 ... 11 mm / 0.35 ... 0.43 inch	

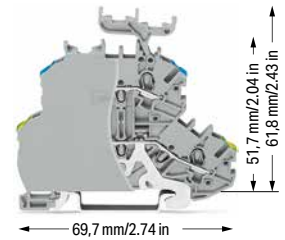
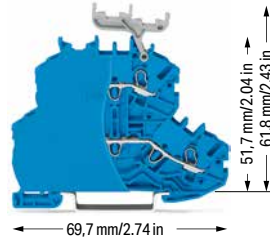
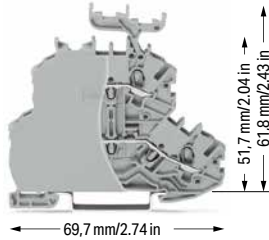

Double-deck terminal block; through/through terminal block; with end plate; with marker carrier; gray

	Item No.	Pack. Unit
○ L/L ④	2000-2231/099-000 ④	50
○ N/L ④	2000-2232/099-000 ④	50
○ L/N ④	2000-2233/099-000 ④	50

Double-deck terminal block; through/through terminal block; with end plate; with marker carrier; blue

	Item No.	Pack. Unit
● N/N ④	2000-2234/099-000 ④	50

Double-deck terminal block; ground conductor/through terminal block; with end plate; with marker carrier; gray

	Item No.	Pack. Unit
○ PE/N ④	2000-2247/099-000 ④	50
○ PE/L ④	2000-2257/099-000 ④	50

Double-deck terminal block; through/through terminal block; with end plate; without marker carrier; gray

○ L/L ④	2000-2201/099-000 ④	50
○ N/L ④	2000-2202/099-000 ④	50
○ L/N ④	2000-2203/099-000 ④	50

Double-deck terminal block; through/through terminal block; with end plate; without marker carrier; blue

● N/N ④	2000-2204/099-000 ④	50
---------	---------------------	----

Double-deck terminal block; ground conductor/through terminal block; with end plate; without marker carrier; gray

○ PE/N ④	2000-2217/099-000 ④	50
○ PE/L ④	2000-2227/099-000 ④	50

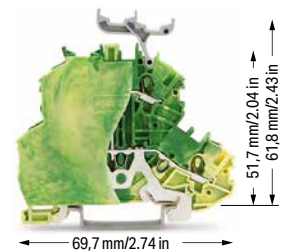
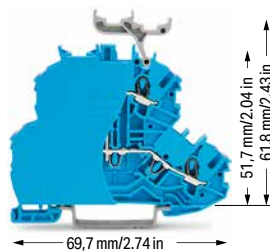
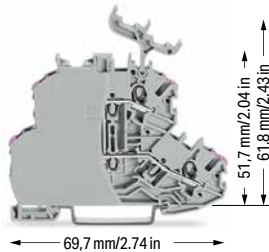

Double-deck terminal block; 4-conductor through terminal block; with end plate; with marker carrier; internally commoded; violet conductor entry; gray

	Item No.	Pack. Unit
○ L ④	2000-2238/099-000 ④	50

Double-deck terminal block; 4-conductor through terminal block; with end plate; with marker carrier; internally commoded; violet conductor entry; blue

	Item No.	Pack. Unit
● N ④	2000-2239/099-000 ④	50

Double-deck terminal block; 4-conductor ground terminal block; with end plate; with marker carrier; internally commoded; green-yellow

	Item No.	Pack. Unit
● PE ④	2000-2237/099-000 ④	50

Double-deck terminal block; 4-conductor through terminal block; with end plate; without marker carrier; internally commoded; violet conductor entry; gray

○ L ④	2000-2208/099-000 ④	50
-------	---------------------	----

Double-deck terminal block; 4-conductor through terminal block; with end plate; without marker carrier; internally commoded; violet conductor entry; blue

● N ④	2000-2209/099-000 ④	50
-------	---------------------	----

Double-deck terminal block; 4-conductor ground terminal block; with end plate; without marker carrier; internally commoded; green-yellow

● PE ④	2000-2207/099-000 ④	50
--------	---------------------	----

Technical Data

0.14 ... 1 (1.5) mm² ① | 24 ... 16 AWG

800 V/8 kV/3 ② | 600 V, 10 A ③

I_N 13.5 A (16 A)

Terminal block width: 4.2 mm / 0.165 inch

9 ... 11 mm / 0.35 ... 0.43 inch

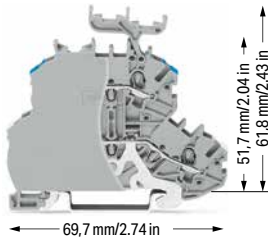

Double-deck terminal block; shield/through terminal block; with end plate; with marker carrier; gray

	Item No.	Pack. Unit
○ Shield/N	2000-2248/099-000	50
○ Shield/L	2000-2258/099-000	50

Double-deck terminal block; shield/through terminal block; with end plate; without marker carrier; gray

	Item No.	Pack. Unit
○ Shield/N	2000-2218/099-000	50
○ Shield/L	2000-2228/099-000	50

① Conductor range: 0.14 ... 1.5 mm² "s+f-st"; Push-in termination: 0.5 ... 1.5 mm² "s" and 0.5 ... 0.75 mm² "insulated ferrules; 10 mm" Depending on the conductor characteristic, a conductor with a smaller cross section can also be inserted via push-in termination.

② 800 V = rated voltage
8 kV = rated impulse voltage
3 = pollution degree (see Section 15)

③ Terminal blocks with a blue insulated housing are suitable for Ex i applications.

④ Terminal blocks with an Ex mark are suitable for Ex e II applications.
550 V; 13 A
12 A jumper (see Section 15)

Please observe the application notes:

Jumpers, from page 165

Testing accessories, page 173

Marking, from page 640

Approvals and corresponding ratings, visit www.wago.com

Accessories; 2000 Series

Appropriate marking systems:
WMB/WMB Inline/Marking strips

End and intermediate plate; 0.7 mm thick

	orange	2000-2292	25
	gray	2000-2291	25

Ex e/Ex i separator; orange; 3 mm thick

	125.5 mm	209-192	50 (25)
---	----------	---------	---------

Push-in type jumper bar; insulated; I_N 18 A; light gray

	2-way	2001-402	25
	3-way	2001-403	25
	4-way	2001-404	25
	5-way	2001-405	25
	6-way	2001-406	25
	7-way	2001-407	25
	8-way	2001-408	25
	9-way	2001-409	25
	10-way	2001-410	25

Push-in type jumper bar; insulated; I_N 18 A; light gray

	1 to 3	2001-433	25
	1 to 4	2001-434	25
	1 to 5	2001-435	25
	1 to 6	2001-436	25
	1 to 7	2001-437	25
	1 to 8	2001-438	25
	1 to 9	2001-439	25
	1 to 10	2001-440	25

Double-deck vertical jumper; insulated; I_N 13.5 A

	light gray	2000-492	100 (25)
---	------------	----------	----------

Protective warning marker; with black high-voltage symbol; for 5 terminal blocks

	yellow	2001-115	100 (25)
---	--------	----------	----------

Test plug adapter; for 4 mm Ø test plug

	gray	2009-174	100 (25)
---	------	----------	----------

Accessories; 2000 Series

Appropriate marking systems:
WMB/WMB Inline/Marking stripsTesting tap; for max. 2.5 mm²

	gray	2009-182	100 (25)
---	------	----------	----------

Marking strip; plain; 11 mm wide; 50 m reel

	white	2009-110	1
---	-------	----------	---

WMB Inline; plain; 2,000 WMB markers (4 mm)/reel; 4 ... 4.2 mm stretchable

	white	2009-114	1
---	-------	----------	---

WMB marking card; white; 10 strips with 10 markers/card; 4 ... 4.2 mm stretchable

	plain	793-4501	5
---	-------	----------	---

Double-deck marker carrier; pivoting

	gray	2000-121	50 (25)
---	------	----------	---------



Double-deck terminal blocks:

A double-deck marker carrier (2000-121) can be retrofitted to double-deck terminal blocks without a marker carrier.

Double-Deck Terminal Block TOPJOB® S

2.5 (4) mm²; 2002 Series

1

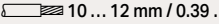
Technical Data	
0.25 ... 2.5 (4) mm ² ①	22 ... 12 AWG
500 V/6 kV/3 ②	300 V, 20 A ③
I _N 24 A (28 A)	600 V, 20 A ④
Terminal block width: 5.2 mm / 0.205 inch	
 10 ... 12 mm / 0.39 ... 0.47 inch	

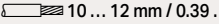
Technical Data	
0.25 ... 2.5 (4) mm ² ①	22 ... 12 AWG
500 V/6 kV/3 ②	300 V, 20 A ③
I _N 24 A (28 A)	600 V, 20 A ④
Terminal block width: 5.2 mm / 0.205 inch	
 10 ... 12 mm / 0.39 ... 0.47 inch	

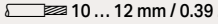
Technical Data	
0.25 ... 2.5 (4) mm ² ①	22 ... 12 AWG
500 V/6 kV/3 ②	300 V, 20 A ③
I _N 24 A (28 A)	600 V, 20 A ④
Terminal block width: 5.2 mm / 0.205 inch	
 10 ... 12 mm / 0.39 ... 0.47 inch	

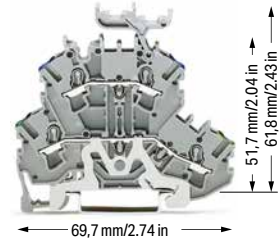
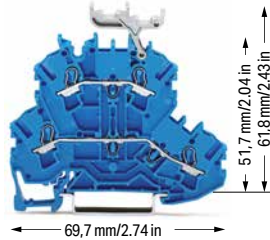
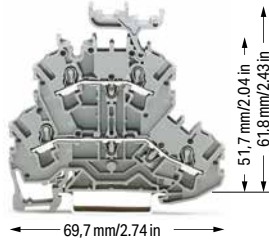

Double-deck terminal block; through/through terminal block; with marker carrier; gray

	Item No.	Pack. Unit
○ L/L ⑤	2002-2231 ④	50
○ N/L ⑤	2002-2232 ④	50
○ L/N ⑤	2002-2233 ④	50

Double-deck terminal block; through/through terminal block; with marker carrier; blue

	Item No.	Pack. Unit
● N/N ⑤	2002-2234 ③ ④	50

Double-deck terminal block; ground conductor/through terminal block; with marker carrier; blue

	Item No.	Pack. Unit
○ PE/N ⑤	2002-2247 ④	50
○ PE/L ⑤	2002-2257 ④	50

Double-deck terminal block; through/through terminal block; without marker carrier; gray

○ L/L ⑤	2002-2201 ④	50
○ N/L ⑤	2002-2202 ④	50
○ L/N ⑤	2002-2203 ④	50

Double-deck terminal block; through/through terminal block; without marker carrier; blue

● N/N ⑤	2002-2204 ③ ④	50
---------	---------------	----

Double-deck terminal block; ground conductor/through terminal block; without marker carrier; gray

○ PE/N ⑤	2002-2217 ④	50
○ PE/L ⑤	2002-2227 ④	50

Double-deck terminal block; through/through terminal block; without marker carrier; orange

● N/L ⑤	2002-2206 ④	50
---------	-------------	----

Other terminal blocks with the same profile:

Diode	2002-2211/1000-410	Page 164
LED	2002-2221/1000-434	Page 164

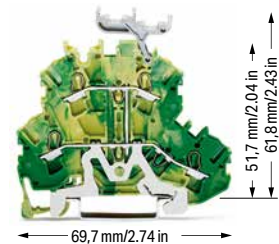
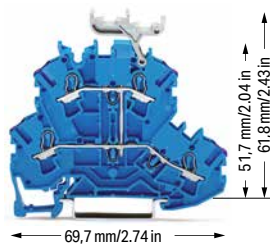
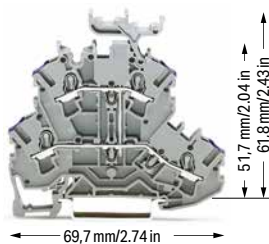

Double-deck terminal block; 4-conductor through terminal block; with marker carrier; internally commoned; violet conductor entry; gray

	Item No.	Pack. Unit
○ L ⑤	2002-2238 ④	50

Double-deck terminal block; 4-conductor through terminal block; with marker carrier; internally commoned; violet conductor entry; blue

	Item No.	Pack. Unit
● N ⑤	2002-2239 ③ ④	50

Double-deck terminal block; 4-conductor ground terminal block; with marker carrier; internally commoned; green-yellow

	Item No.	Pack. Unit
● PE ⑤	2002-2237 ④	50

Double-deck terminal block; 4-conductor through terminal block; without marker carrier; internally commoned; violet conductor entry; gray

○ L ⑤	2002-2208 ④	50
-------	-------------	----

Double-deck terminal block; 4-conductor through terminal block; without marker carrier; internally commoned; violet conductor entry; blue

● N ⑤	2002-2209 ③ ④	50
-------	---------------	----

Double-deck terminal block; 4-conductor ground terminal block; without marker carrier; internally commoned; green-yellow

● PE ⑤	2002-2207 ④	50
--------	-------------	----

Technical Data

0.25 ... 2.5 (4) mm ² ①	22 ... 12 AWG
500 V/6 kV/3 ②	300 V, 20 A ③
I _N 24 A (28 A)	600 V, 20 A ④
Terminal block width: 5.2 mm / 0.205 inch	
10 ... 12 mm / 0.39 ... 0.47 inch	

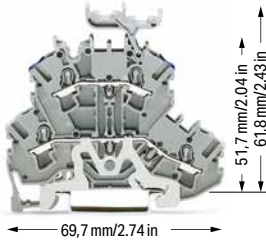

Double-deck terminal block; shield/through terminal block; with marker carrier; gray

	Item No.	Pack. Unit
○ Shield/N	2002-2248	50
○ Shield/L	2002-2258	50

Double-deck terminal block; shield/through terminal block; without marker carrier; gray

○ Shield/N	2002-2218	50
○ Shield/L	2002-2228	50

- Conductor range: 0.25 ... 4 mm² "s+f-st"; Push-in termination: 1 ... 4 mm² "s" and 1 ... 2.5 mm² "insulated ferrules, 12 mm" Depending on the conductor characteristic, a conductor with a smaller cross section can also be inserted via push-in termination.
- 500 V = rated voltage
6 kV = rated impulse voltage
3 = pollution degree (see Section 15)
- Terminal blocks with a blue insulated housing are suitable for Ex i applications.
- Terminal blocks with an Ex mark are suitable for Ex e II applications.
440 V; 20 A
18 A jumper (see Section 15)

Please observe the application notes:
Jumpers, from page 174
Testing accessories, page 173
Marking, from page 640

Approvals and corresponding ratings, visit www.wago.com

Accessories; 2002 Series

Appropriate marking systems:
WMB/WMB Inline/Marking strips

End and intermediate plate; 0.8 mm thick

orange	2002-2292	100 (25)
gray	2002-2291	100 (25)

Ex e/Ex i separator; orange; 3 mm thick

125.5 mm	209-192	50 (25)
----------	---------	---------

Separator plate; oversized upper deck; snap-on type; 2 mm thick

orange	2002-2296	100 (25)
gray	2002-2295	100 (25)

Insulation stop; 5 pcs/strip; 0.25 ... 0.5 mm²

light gray	2002-171	200 (25)
------------	----------	----------

Insulation stop; 5 pcs/strip; 0.75 ... 1 mm²

dark gray	2002-172	200 (25)
-----------	----------	----------

Push-in type jumper bar; insulated; I_N 25 A; light gray

2-way	2002-402	25
3-way	2002-403	25
4-way	2002-404	25
5-way	2002-405	25
6-way	2002-406	25
7-way	2002-407	25
8-way	2002-408	25
9-way	2002-409	25
10-way	2002-410	25

Push-in type jumper bar; insulated; I_N 25 A; light gray

1 to 3	2002-433	25
1 to 4	2002-434	25
1 to 5	2002-435	25
1 to 6	2002-436	25
1 to 7	2002-437	25
1 to 8	2002-438	25
1 to 9	2002-439	25
1 to 10	2002-440	25

Accessories; 2002 Series

Appropriate marking systems:
WMB/WMB Inline/Marking strips

Double-deck vertical jumper; insulated; I_N 24 A

light gray	2002-492	100 (25)
orange	2002-492/000-012	100 (25)

Double-deck marker carrier; pivoting

gray	2002-121	50 (25)
------	----------	---------

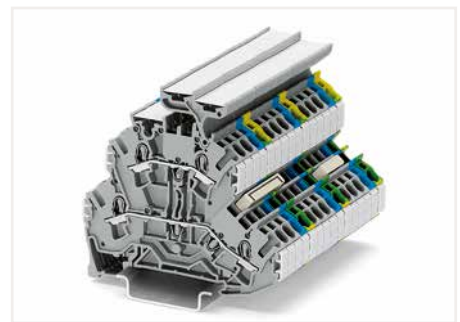

Double-deck terminal block assembly

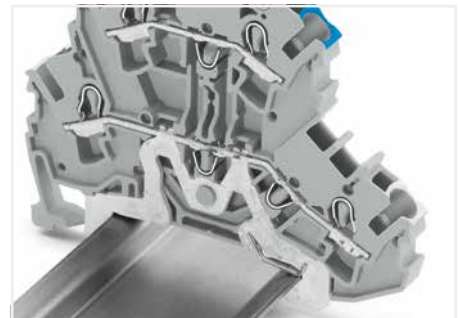

Both ground and shield conductor terminal blocks have a contact foot in the bottom level, automatically establishing direct contact to the DIN-rail or busbar. The flexible double-deck marker carrier, which is placed above the wiring level, can be pushed aside during wiring. The carrier has two staggered levels for WMB markers that perfectly align with the terminal block decks. With a terminal block width of just 5.2 mm, an effective width of just 2.6 mm for terminal blocks of same or different potentials can be realized for conductors ranging 0.25 mm² ... 4 mm² (22 ... 12 AWG). Shielded control cables are becoming an increasingly common solution to external signal interference. Front-entry shield conductor terminal blocks are ideal for connecting braided cables. Like front-entry ground conductor terminal blocks, they are equipped with a grounding foot for direct electrical connection to the rail, however they differ significantly by their white insulated housing. Shield conductor terminal blocks for front-entry wiring can be directly mounted beside signal-conductor terminal blocks, providing excellent deflection of interfering signals.

Double-Deck Terminal Block TOPJOB® S; with End Plate; 800 V 2.5 (4) mm²; 2002 Series

1

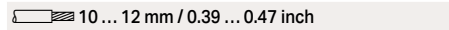
Technical Data	
0.25 ... 2.5 (4) mm ² ①	22 ... 12 AWG
800 V/8 kV/3 ②	600 V, 20 A ③
I _N 24 A	600 V, 20 A ④
Terminal block width: 6.2 mm / 0.244 inch	
 10 ... 12 mm / 0.39 ... 0.47 inch	

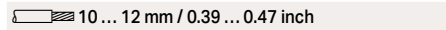
Technical Data	
0.25 ... 2.5 (4) mm ² ①	22 ... 12 AWG
800 V/8 kV/3 ②	600 V, 20 A ③
I _N 24 A	600 V, 20 A ④
Terminal block width: 6.2 mm / 0.244 inch	
 10 ... 12 mm / 0.39 ... 0.47 inch	

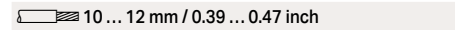
Technical Data	
0.25 ... 2.5 (4) mm ² ①	22 ... 12 AWG
800 V/8 kV/3 ②	600 V, 20 A ③
I _N 24 A	600 V, 20 A ④
Terminal block width: 6.2 mm / 0.244 inch	
 10 ... 12 mm / 0.39 ... 0.47 inch	

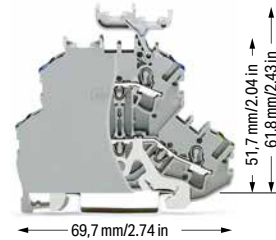
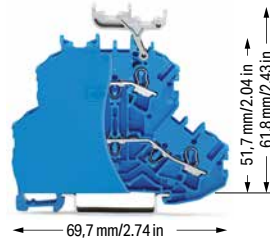
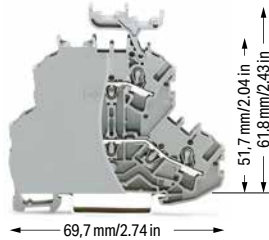

Double-deck terminal block; through/through terminal block; with end plate; with marker carrier; gray

	Item No.	Pack. Unit
<input type="radio"/> L/L	2002-2231/099-000	50
<input type="radio"/> N/L	2002-2232/099-000	50
<input type="radio"/> L/N	2002-2233/099-000	50

Double-deck terminal block; through/through terminal block; with end plate; with marker carrier; blue

	Item No.	Pack. Unit
<input checked="" type="radio"/> N/N	2002-2234/099-000 ③	50

Double-deck terminal block; ground conductor/through terminal block; with end plate; with marker carrier; gray

	Item No.	Pack. Unit
<input type="radio"/> PE/N	2002-2247/099-000	50
<input type="radio"/> PE/L	2002-2257/099-000	50

Double-deck terminal block; through/through terminal block; with end plate; without marker carrier; gray

<input type="radio"/> L/L	2002-2201/099-000	50
<input type="radio"/> N/L	2002-2202/099-000	50
<input type="radio"/> L/N	2002-2203/099-000	50

Double-deck terminal block; through/through terminal block; with end plate; without marker carrier; blue

<input checked="" type="radio"/> N/N	2002-2204/099-000 ③	50
--------------------------------------	---------------------	----

Double-deck terminal block; ground conductor/through terminal block; with end plate; without marker carrier; gray

<input type="radio"/> PE/N	2002-2217/099-000	50
<input type="radio"/> PE/L	2002-2227/099-000	50

Other terminal blocks with the same profile:		
Diode	2002-2211/1000-410	Page 164
LED	2002-2221/1000-434	Page 164

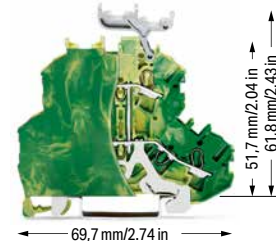
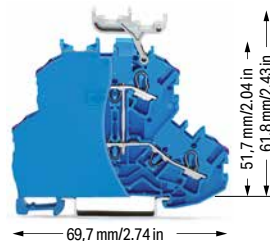
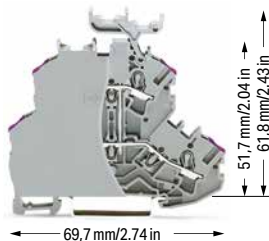

Double-deck terminal block; 4-conductor through terminal block; with end plate; with marker carrier; internally commoned; violet conductor entry; gray

	Item No.	Pack. Unit
<input type="radio"/> L	2002-2238/099-000	50

Double-deck terminal block; 4-conductor through terminal block; with end plate; with marker carrier; internally commoned; violet conductor entry; blue

	Item No.	Pack. Unit
<input checked="" type="radio"/> N	2002-2239/099-000 ③	50

Double-deck terminal block; 4-conductor ground terminal block; with end plate; with marker carrier; internally commoned; green-yellow

	Item No.	Pack. Unit
<input checked="" type="radio"/> PE	2002-2237/099-000	50

Double-deck terminal block; 4-conductor through terminal block; with end plate; without marker carrier; internally commoned; violet conductor entry; gray

<input type="radio"/> L	2002-2208/099-000	50
-------------------------	-------------------	----

Double-deck terminal block; 4-conductor through terminal block; with end plate; without marker carrier; internally commoned; violet conductor entry; blue

<input checked="" type="radio"/> N	2002-2209/099-000 ③	50
------------------------------------	---------------------	----

Double-deck terminal block; 4-conductor ground terminal block; with end plate; without marker carrier; internally commoned; green-yellow

<input checked="" type="radio"/> PE	2002-2207/099-000	50
-------------------------------------	-------------------	----

Technical Data

0.25 ... 2.5 (4) mm ² ①	22 ... 12 AWG
800 V/8 kV/3 ②	600 V, 20 A ③
I _N 24 A	600 V, 20 A ③
Terminal block width: 6.2 mm / 0.244 inch	
 10 ... 12 mm / 0.39 ... 0.47 inch	

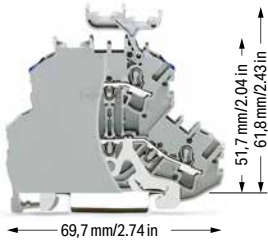

Double-deck terminal block; shield/through terminal block; with end plate; with marker carrier; gray

	Item No.	Pack. Unit
○ Shield/N	2002-2248/099-000	50
○ Shield/L	2002-2258/099-000	50

Double-deck terminal block; shield/through terminal block; with end plate; without marker carrier; gray

○ Shield/N	2002-2218/099-000	50
○ Shield/L	2002-2228/099-000	50

① Conductor range: 0.25 ... 4 mm² "s+f-st";
Push-in termination: 1 ... 4 mm² "s" and 1 ... 2.5 mm² "insulated ferrules, 12 mm"
Depending on the conductor characteristic, a conductor with a smaller cross section can also be inserted via push-in termination.

② 800 V = rated voltage
8 kV = rated impulse voltage
3 = pollution degree (see Section 15)

③ Terminal blocks with a blue insulated housing are suitable for Ex i applications.

Please observe the application notes:
Jumpers, from page 165
Testing accessories, page 173
Marking, from page 640

A protective warning marker and an insulation stop must be applied individually. Due to the 6.2 mm width of double-deck terminal blocks with end plates, 2004 Series Push-In Type Jumper Bars must be used.

Approvals and corresponding ratings, visit www.wago.com

Accessories; 2002 Series

Appropriate marking systems:
WMB/Marking strips

End and intermediate plate; 0.8 mm thick

	orange	2002-2292	100 (25)
	gray	2002-2291	100 (25)

Insulation stop; 5 pcs/strip; 0.25 ... 0.5 mm²

	light gray	2002-171	200 (25)
---	------------	----------	----------

Insulation stop; 5 pcs/strip; 0.75 ... 1 mm²

	dark gray	2002-172	200 (25)
---	-----------	----------	----------

Push-in type jumper bar; insulated; I_N 32 A; light gray

	2-way	2004-402	25
	3-way	2004-403	25
	4-way	2004-404	25
	5-way	2004-405	25
	6-way	2004-406	25
	7-way	2004-407	25
	8-way	2004-408	25
	9-way	2004-409	25
	10-way	2004-410	25

Push-in type jumper bar; insulated; I_N 32 A; light gray

	1 to 3	2004-433	25
	1 to 4	2004-434	25
	1 to 5	2004-435	25
	1 to 6	2004-436	25
	1 to 7	2004-437	25
	1 to 8	2004-438	25
	1 to 9	2004-439	25
	1 to 10	2004-440	25

Double-deck vertical jumper; insulated; I_N 24 A

	light gray	2002-492	100 (25)
	orange	2002-492/000-012	100 (25)

Protective warning marker; with black high-voltage symbol; for 5 terminal blocks

	yellow	2002-115	100 (25)
---	--------	----------	----------

Accessories; 2002 Series

Appropriate marking systems:
WMB/Marking strips

Test plug adapter; for 4 mm Ø test plug

	gray	2009-174	100 (25)
---	------	----------	----------

Testing tap; for max. 2.5 mm²

	gray	2009-182	100 (25)
---	------	----------	----------

Marking strip; plain; 11 mm wide; 50 m reel

	white	2009-110	1
---	-------	----------	---

WMB marking card; white; 10 strips with 10 markers/card; 5 ... 5.2 mm stretchable

	plain	793-5501	5
---	-------	----------	---

Double-deck marker carrier; pivoting

	gray	2002-121	50 (25)
---	------	----------	---------

Double-Deck Terminal Block TOPJOB® S

2.5 (4) mm²; 2002 Series

1

Technical Data

0.25 ... 2.5 (4) mm² ① | 22 ... 12 AWG

1000 VAC/DC / 1500 VDC / 12 kV / 3 ②

I_N 24 A | 1000 V, 20 A ③

Terminal block width: 7.2 mm / 0.283 inch

 10 ... 12 mm / 0.39 ... 0.47 inch

Technical Data

0.25 ... 2.5 (4) mm² ① | 22 ... 12 AWG

1000 VAC/DC / 1500 VDC / 12 kV / 3 ②

I_N 24 A | 1000 V, 20 A ③

Terminal block width: 7.2 mm / 0.283 inch

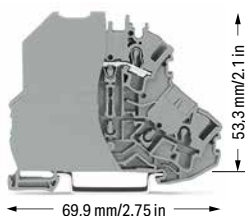
 10 ... 12 mm / 0.39 ... 0.47 inch

Double-deck terminal block; contact insert only on upper deck; gray separator plate; oversized; gray

	Item No.	Pack. Unit
○ L	2002-2201/097-000	50

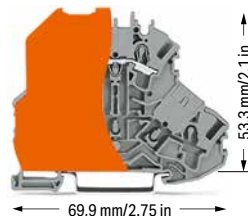

Double-deck terminal block; contact insert only on upper deck; orange separator plate; oversized; gray

	Item No.	Pack. Unit
○ L	2002-2201/098-000	50

Accessories; 2002 Series

Appropriate marking systems: WMB/Marking strips

Insulation stop; 5 pcs/strip; 0.25 ... 0.5 mm²

	light gray	2002-171	200 (25)
--	------------	----------	----------

Insulation stop; 5 pcs/strip; 0.75 ... 1 mm²

	dark gray	2002-172	200 (25)
---	-----------	----------	----------

Protective warning marker; with black high-voltage symbol; for 5 terminal blocks

	yellow	2002-115	100 (25)
---	--------	----------	----------

Test plug adapter; for 4 mm Ø test plug

	gray	2009-174	100 (25)
---	------	----------	----------

Testing tap; for max. 2.5 mm²

	gray	2009-182	100 (25)
---	------	----------	----------

Marking strip; plain; 11 mm wide; 50 m reel

	white	2009-110	1
---	-------	----------	---

WMB marking card; white; 10 strips with 10 markers/card; 5 ... 5.2 mm stretchable

	plain	793-5501	5
---	-------	----------	---

Double-deck marker carrier; pivoting

	gray	2002-121	50 (25)
---	------	----------	---------

① Conductor range: 0.25 ... 4 mm² "s+f-st";
Push-in termination: 1 ... 4 mm² "s" and 1 ... 2.5 mm²
"insulated ferrules, 12 mm"
Depending on the conductor characteristic, a conductor with a smaller cross section can also be inserted via push-in termination.

② 1000 VAC/DC = rated voltage
1500 VDC
12 kV = rated impulse voltage
3 = pollution degree
(see Section 15)

Please observe the application notes:
Testing accessories, page 173
Marking, from page 640

A protective warning marker and an insulation stop must be applied individually.

Approvals and corresponding ratings,
visit www.wago.com

Double-Deck Terminal Block TOPJOB® S; with Vertical Conductor Entry 2.5 (4) mm²; 2002 Series

Technical Data	
0.25 ... 2.5 (4) mm ² ①	22 ... 12 AWG
800 V/8 kV/3 ②	600 V, 20 A ③
I _N 24 A (28 A)	600 V, 24 A ④
Terminal block width: 5.2 mm / 0.205 inch	
 10 ... 12 mm / 0.39 ... 0.47 inch	

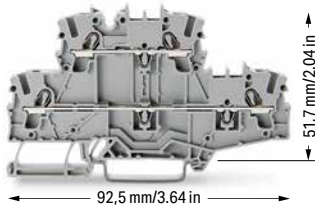

Double-deck terminal block; through/through terminal block; with vertical conductor entry; without marker carrier; gray

	Item No.	Pack. Unit
○ L/L ⑤	2002-2701 ④	50
○ N/L ⑤	2002-2702 ④	50
○ L/N ⑤	2002-2703 ④	50

Double-deck terminal block; through/through terminal block; with vertical conductor entry; without marker carrier; blue

● N/N ⑤	2002-2704 ④	50
---------	-------------	----

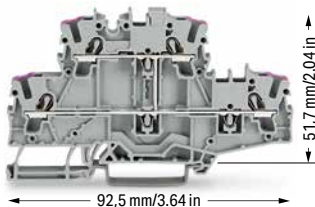

Double-deck terminal block; 4-conductor through terminal block; with vertical conductor entry; without marker carrier; internally commoned; violet conductor entry; gray

	Item No.	Pack. Unit
○ L ⑤	2002-2708 ④	50

Double-deck terminal block; 4-conductor through terminal block; with vertical conductor entry; without marker carrier; internally commoned; violet conductor entry; blue

● N ⑤	2002-2709 ④	50
-------	-------------	----

Technical Data	
0.25 ... 2.5 (4) mm ² ①	22 ... 12 AWG
800 V/8 kV/3 ②	600 V, 20 A ③
I _N 24 A (28 A)	600 V, 24 A ④
Terminal block width: 5.2 mm / 0.205 inch	
 10 ... 12 mm / 0.39 ... 0.47 inch	

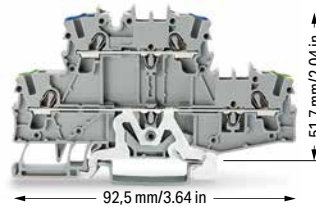

Double-deck terminal block; ground conductor/through terminal block; with vertical conductor entry; without marker carrier; gray

	Item No.	Pack. Unit
○ PE/N ⑤	2002-2717 ④	50
○ PE/L ⑤	2002-2727 ④	50

Double-deck terminal block; 4-conductor ground terminal block; with vertical conductor entry; without marker carrier; internally commoned; green-yellow

	Item No.	Pack. Unit
● PE	2002-2707	50
● PE ⑤	2002-2707/999-950 ④	50

① Conductor range: 0.25 ... 4 mm² "s+f-st"; Push-in termination: 1 ... 4 mm² "s" and 1 ... 2.5 mm² "insulated ferrules, 12 mm"
Depending on the conductor characteristic, a conductor with a smaller cross section can also be inserted via push-in termination.

② 800 V = rated voltage
8 kV = rated impulse voltage
3 = pollution degree (see Section 15)

③ Terminal blocks with a blue insulated housing are suitable for Ex i applications.

④ Terminal blocks with an Ex mark are suitable for Ex e II applications.
550 V; 21 A
17 A jumper and 16 A staggered jumper (see Section 15)



Please observe the application notes:
Jumpers, from page 174
Testing accessories, page 173
Marking, from page 640

Approvals and corresponding ratings, visit www.wago.com

Accessories; 2002 Series

Appropriate marking systems:
WMB/WMB Inline/Marking strips

End and intermediate plate; 0.8 mm thick

	orange	2002-2792	100 (25)
	gray	2002-2791	100 (25)

Ex e/Ex i separator; orange; 3 mm thick

	125.5 mm	209-192	50 (25)
---	----------	---------	---------

Insulation stop; 5 pcs/strip; 0.25 ... 0.5 mm²

	light gray	2002-171	200 (25)
---	------------	----------	----------

Insulation stop; 5 pcs/strip; 0.75 ... 1 mm²

	dark gray	2002-172	200 (25)
---	-----------	----------	----------

Push-in type jumper bar; insulated; I_N 25 A; light gray

	2-way	2002-402	25
	3-way	2002-403	25
	4-way	2002-404	25
	5-way	2002-405	25
	6-way	2002-406	25
	7-way	2002-407	25
	8-way	2002-408	25
	9-way	2002-409	25
	10-way	2002-410	25

Push-in type jumper bar; insulated; I_N 25 A; light gray

	1 to 3	2002-433	25
	1 to 4	2002-434	25
	1 to 5	2002-435	25
	1 to 6	2002-436	25
	1 to 7	2002-437	25
	1 to 8	2002-438	25
	1 to 9	2002-439	25
	1 to 10	2002-440	25

Double-deck vertical jumper; insulated; I_N 24 A

	light gray	2002-492	100 (25)
	orange	2002-492/000-012	100 (25)

Double-deck marker carrier; pivoting

	gray	2002-121	50 (25)
---	------	----------	---------

4-Conductor Double-Deck Terminal Block TOPJOB® S

2.5 (4) mm²; 2002 Series

1

Technical Data	
0.25 ... 2.5 (4) mm ² ①	22 ... 12 AWG
800 V/8 kV/3 ②	600 V, 20 A ③
I _N 24 A (28 A)	600 V, 20 A ④
Terminal block width: 5.2 mm / 0.205 inch	
 10 ... 12 mm / 0.39 ... 0.47 inch	

Technical Data	
0.25 ... 2.5 (4) mm ² ①	22 ... 12 AWG
800 V/8 kV/3 ②	600 V, 20 A ③
I _N 24 A (28 A)	600 V, 20 A ④
Terminal block width: 5.2 mm / 0.205 inch	
 10 ... 12 mm / 0.39 ... 0.47 inch	

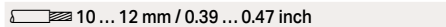
Technical Data	
0.25 ... 2.5 (4) mm ² ①	22 ... 12 AWG
800 V/8 kV/3 ②	600 V, 20 A ③
I _N 24 A (28 A)	600 V, 20 A ④
Terminal block width: 5.2 mm / 0.205 inch	
 10 ... 12 mm / 0.39 ... 0.47 inch	

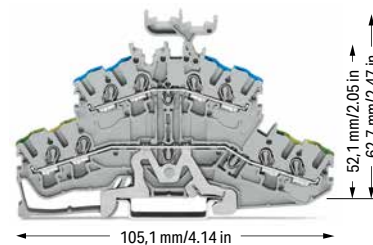
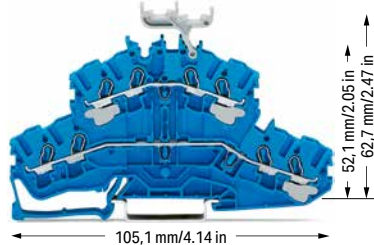
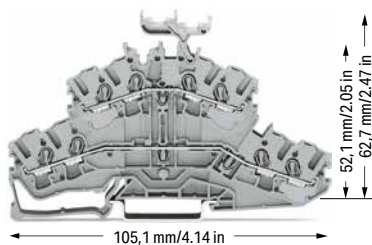

4-conductor double-deck terminal block; through/through terminal block; with marker carrier; gray

	Item No.	Pack. Unit
○ L/L ⑤	2002-2431 ④	50
○ N/L ⑤	2002-2432 ④	50
○ L/N ⑤	2002-2433 ④	50

4-conductor double-deck terminal block; through/through terminal block; with marker carrier; blue

	Item No.	Pack. Unit
● N/N ⑤	2002-2434 ③ ④	50

4-conductor double-deck terminal block; ground conductor/through terminal block; with marker carrier; gray

	Item No.	Pack. Unit
○ PE/N ⑤	2002-2447 ④	50
○ PE/L ⑤	2002-2457 ④	50

4-conductor double-deck terminal block; through/through terminal block; without marker carrier; gray

	Item No.	Pack. Unit
○ L/L ⑤	2002-2401 ④	50
○ N/L ⑤	2002-2402 ④	50
○ L/N ⑤	2002-2403 ④	50

4-conductor double-deck terminal block; through/through terminal block; without marker carrier; blue

	Item No.	Pack. Unit
● N/N ⑤	2002-2404 ③ ④	50

4-conductor double-deck terminal block; ground conductor/through terminal block; without marker carrier; gray

	Item No.	Pack. Unit
○ PE/N ⑤	2002-2417 ④	50
○ PE/L ⑤	2002-2427 ④	50

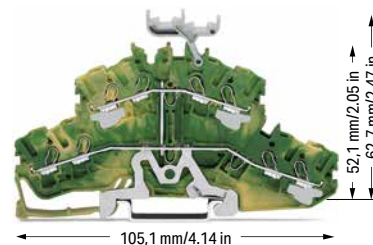
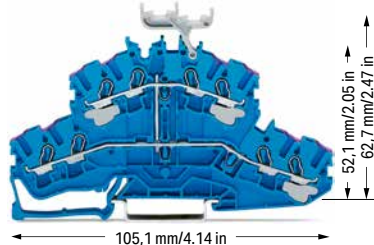
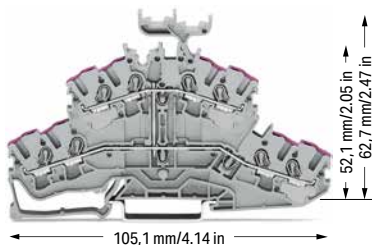

4-conductor double-deck terminal block; 8-conductor through terminal block; with marker carrier; internally commoned; violet conductor entry; gray

	Item No.	Pack. Unit
○ L ⑤	2002-2438 ④	50

4-conductor double-deck terminal block; 8-conductor through terminal block; with marker carrier; internally commoned; violet conductor entry; blue

	Item No.	Pack. Unit
● N ⑤	2002-2439 ③ ④	50

4-conductor double-deck terminal block; 8-conductor ground terminal block; with marker carrier; internally commoned; green-yellow

	Item No.	Pack. Unit
● PE ⑤	2002-2437 ④	50

4-conductor double-deck terminal block; 8-conductor through terminal block; without marker carrier; internally commoned; violet conductor entry; gray

	Item No.	Pack. Unit
○ L ⑤	2002-2408 ④	50

4-conductor double-deck terminal block; 8-conductor through terminal block; without marker carrier; internally commoned; violet conductor entry; blue

	Item No.	Pack. Unit
● N ⑤	2002-2409 ③ ④	50

4-conductor double-deck terminal block; 8-conductor ground terminal block; without marker carrier; internally commoned; green-yellow

	Item No.	Pack. Unit
● PE ⑤	2002-2407 ④	50

Technical Data

0.25 ... 2.5 (4) mm ² ①	22 ... 12 AWG
800 V/8 kV/3 ②	600 V, 20 A ③
I _N 24 A (28 A)	600 V, 20 A ④
Terminal block width: 5.2 mm / 0.205 inch	

10 ... 12 mm / 0.39 ... 0.47 inch

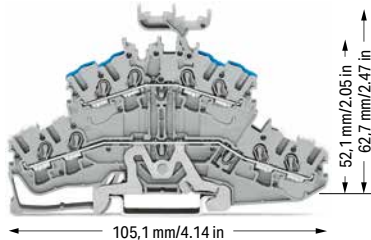

4-conductor double-deck terminal block; shield/through terminal block; with marker carrier; gray

	Item No.	Pack. Unit
○ Shield/N	2002-2448	50
○ Shield/L	2002-2458	50

4-conductor double-deck terminal block; shield/through terminal block; without marker carrier; gray

	Item No.	Pack. Unit
○ Shield/N	2002-2418	50
○ Shield/L	2002-2428	50

① Conductor range: 0.25 ... 4 mm² "s+f-st";
Push-in termination: 1 ... 4 mm² "s" and 1 ... 2.5 mm² "insulated ferrules, 12 mm"
Depending on the conductor characteristic, a conductor with a smaller cross section can also be inserted via push-in termination.

② 800 V = rated voltage
8 kV = rated impulse voltage
3 = pollution degree
(see Section 15)

③ Terminal blocks with a blue insulated housing are suitable for Ex i applications.

④ Terminal blocks with an Ex mark are suitable for Ex e II applications.
550 V; 21 A
17 A jumper and 16 A staggered jumper
(see Section 15)



Please observe the application notes:
Jumpers, from page 174
Testing accessories, page 173
Marking, from page 640

Approvals and corresponding ratings,
visit www.wago.com

Accessories; 2002 Series

Appropriate marking systems:
WMB/WMB Inline/Marking strips

End and intermediate plate; 0.8 mm thick

	orange	2002-2492	100 (25)
	gray	2002-2491	100 (25)

Ex e/Ex i separator; orange; 3 mm thick

	125.5 mm	209-192	50 (25)
---	----------	---------	---------

Insulation stop; 5 pcs/strip; 0.25 ... 0.5 mm²

	light gray	2002-171	200 (25)
---	------------	----------	----------

Insulation stop; 5 pcs/strip; 0.75 ... 1 mm²

	dark gray	2002-172	200 (25)
---	-----------	----------	----------

Push-in type jumper bar; insulated; I_N 25 A; light gray

	2-way	2002-402	25
	3-way	2002-403	25
	4-way	2002-404	25
	5-way	2002-405	25
	6-way	2002-406	25
	7-way	2002-407	25
	8-way	2002-408	25
	9-way	2002-409	25
	10-way	2002-410	25

Push-in type jumper bar; insulated; I_N 25 A; light gray

	1 to 3	2002-433	25
	1 to 4	2002-434	25
	1 to 5	2002-435	25
	1 to 6	2002-436	25
	1 to 7	2002-437	25
	1 to 8	2002-438	25
	1 to 9	2002-439	25
	1 to 10	2002-440	25

Double-deck vertical jumper; insulated; I_N 24 A

	light gray	2002-492	100 (25)
	orange	2002-492/000-012	100 (25)

Accessories; 2002 Series

Appropriate marking systems:
WMB/WMB Inline/Marking strips

Adjacent jumper for continuous commoning; insulated; I_N 25 A; light gray

	2-way	2002-400	25
---	-------	----------	----

Adjacent jumper for continuous commoning; insulated; I_N 25 A; 1 to 3

	light gray	2002-423	25
	red	2002-423/000-005	25
	blue	2002-423/000-006	25

Protective warning marker; with black high-voltage symbol; for 5 terminal blocks

	yellow	2002-115	100 (25)
---	--------	----------	----------

Test plug adapter; for 4 mm Ø test plug

	gray	2009-174	100 (25)
---	------	----------	----------

Testing tap; for max. 2.5 mm²

	gray	2009-182	100 (25)
---	------	----------	----------

Marking strip; plain; 11 mm wide; 50 m reel

	white	2009-110	1
--	-------	----------	---

WMB Inline, plain; 1,500 WMB markers (5 mm)/reel; 5 ... 5.2 mm stretchable

	white	2009-115	1
---	-------	----------	---

WMB marking card; white; 10 strips with 10 markers/card; 5 ... 5.2 mm stretchable

	plain	793-5501	5
---	-------	----------	---

Double-deck marker carrier; pivoting

	gray	2002-121	50 (25)
---	------	----------	---------

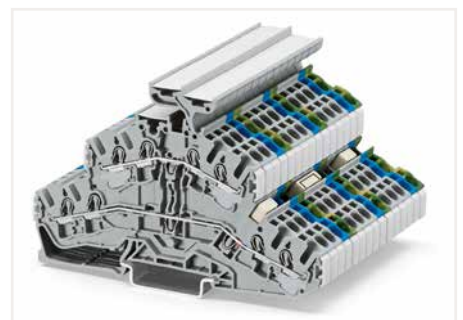

Double-deck terminal block assembly

Double-Deck Terminal Block TOPJOB® S

2.5 (4) mm²; 2002 Series

1

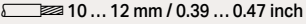
Technical Data	
0.25 ... 2.5 (4) mm ² ①	22 ... 12 AWG
500 V/6 kV/3 ②	300 V, 20 A ③
I _N 24 A (28 A)	300 V, 20 A ④
Terminal block width: 5.2 mm / 0.205 inch	
 10 ... 12 mm / 0.39 ... 0.47 inch	

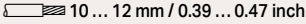
Technical Data	
0.25 ... 2.5 (4) mm ² ①	22 ... 12 AWG
500 V/6 kV/3 ②	300 V, 20 A ③
I _N 24 A (28 A)	300 V, 20 A ④
Terminal block width: 5.2 mm / 0.205 inch	
 10 ... 12 mm / 0.39 ... 0.47 inch	

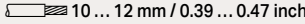
Technical Data	
0.25 ... 2.5 (4) mm ² ①	22 ... 12 AWG
500 V/6 kV/3 ②	300 V, 20 A ③
I _N 24 A (28 A)	300 V, 20 A ④
Terminal block width: 5.2 mm / 0.205 inch	
 10 ... 12 mm / 0.39 ... 0.47 inch	

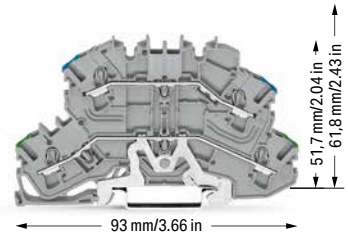
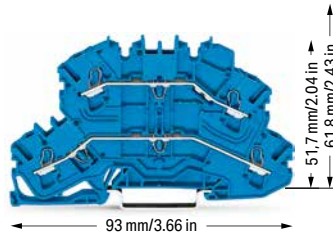
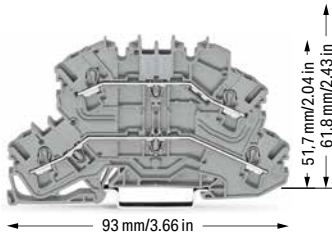

Double-deck terminal block; through/through terminal block; same profile as double-deck disconnect terminal block; without marker carrier; gray

	Item No.	Pack. Unit
○ L/L ⑤	2002-2601 ④	50
○ N/L ⑥	2002-2602 ④	50
○ L/N ⑦	2002-2603 ④	50

Double-deck terminal block; through/through terminal block; same profile as double-deck disconnect terminal block; without marker carrier; blue

	Item No.	Pack. Unit
● N/N ⑧	2002-2604 ③ ④	50

Double-deck terminal block; ground conductor/through terminal block; same profile as double-deck disconnect terminal block; without marker carrier; gray

	Item No.	Pack. Unit
○ PE/N ⑨	2002-2647 ④	50
○ PE/L ⑩	2002-2657 ④	50

Other terminal blocks with the same profile:

Carrier	2002-2661	Page 86
Disconnect	2002-2671	Page 86
Fuse	2002-2611	Page 87

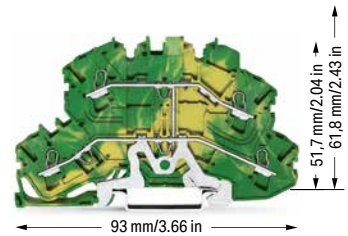
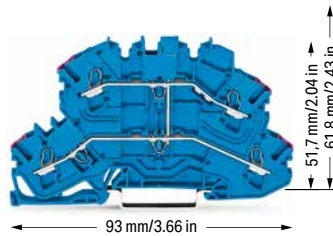
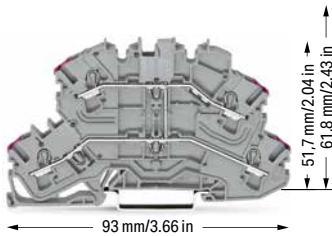

Double-deck terminal block; 4-conductor through terminal block; same profile as double-deck disconnect terminal block; without marker carrier; internally commoned; violet conductor entry; gray

	Item No.	Pack. Unit
○ L ⑪	2002-2608 ④	50

Double-deck terminal block; 4-conductor through terminal block; same profile as double-deck disconnect terminal block; without marker carrier; internally commoned; violet conductor entry; blue

	Item No.	Pack. Unit
● N ⑫	2002-2609 ③ ④	50

Double-deck terminal block; 4-conductor ground terminal block; same profile as double-deck disconnect terminal block; without marker carrier; internally commoned; green-yellow

	Item No.	Pack. Unit
● PE ⑬	2002-2607 ④	50

- ❶ Conductor range: 0.25 ... 4 mm² "s+f-st";
Push-in termination: 1 ... 4 mm² "s" and 1 ... 2.5 mm² "insulated ferrules, 12 mm"
Depending on the conductor characteristic, a conductor with a smaller cross section can also be inserted via push-in termination.
- ❷ 500 V = rated voltage
6 kV = rated impulse voltage
3 = pollution degree
(see Section 15)
- ❸ Terminal blocks with a blue insulated housing are suitable for Ex i applications.
- ❹ Terminal blocks with an Ex mark are suitable for Ex e II applications.
440 V; 14 A
(see Section 15)



Please observe the application notes:
Jumpers, from page 174
Testing accessories, page 173
Marking, from page 640

Approvals and corresponding ratings,
visit www.wago.com

Accessories; 2002 Series

Appropriate marking systems:
WMB/WMB Inline/Marking strips

End and intermediate plate; 1 mm thick

	orange	2002-2692	100 (25)
	gray	2002-2691	100 (25)

Insulation stop; 5 pcs/strip; 0.25 ... 0.5 mm²

	light gray	2002-171	200 (25)
---	------------	----------	----------

Insulation stop; 5 pcs/strip; 0.75 ... 1 mm²

	dark gray	2002-172	200 (25)
---	-----------	----------	----------

Push-in type jumper bar; insulated; I_N 25 A; light gray

	2-way	2002-402	25
	3-way	2002-403	25
	4-way	2002-404	25
	5-way	2002-405	25
	6-way	2002-406	25
	7-way	2002-407	25
	8-way	2002-408	25
	9-way	2002-409	25
	10-way	2002-410	25

Push-in type jumper bar; insulated; I_N 25 A; light gray

	1 to 3	2002-433	25
	1 to 4	2002-434	25
	1 to 5	2002-435	25
	1 to 6	2002-436	25
	1 to 7	2002-437	25
	1 to 8	2002-438	25
	1 to 9	2002-439	25
	1 to 10	2002-440	25

Double-deck vertical jumper; insulated; I_N 24 A

	light gray	2002-492	100 (25)
	orange	2002-492/000-012	100 (25)

Adjacent jumper for continuous commoning; insulated; I_N 25 A, light gray

	2-way	2002-400	25
---	-------	----------	----

Double-deck marker carrier; pivoting

	gray	2002-121	50 (25)
---	------	----------	---------

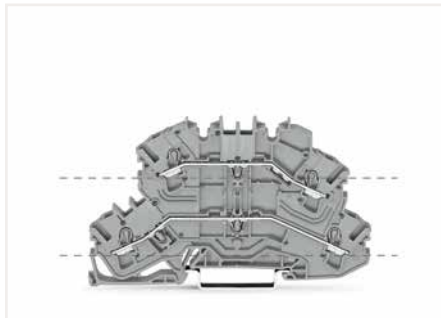

Through terminal blocks (2002-2601) feature two independent current bars on both lower and upper deck, sharing the same profile as disconnect terminal blocks. These terminal blocks can be commoned via double-deck vertical jumpers (2002-492).

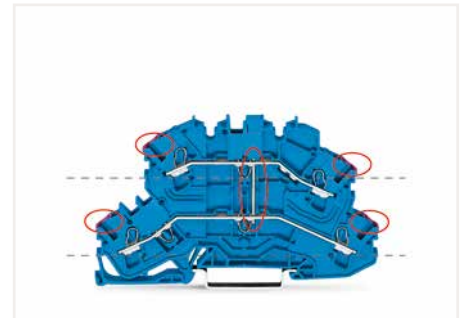

4-conductor through terminal blocks (2002-2609) with internal commoning can be immediately identified via violet conductor entry.



Double-deck disconnect terminal blocks with a pivoting knife disconnect (2002-2671) can be used as through terminal blocks on the lower deck and as disconnect terminal blocks on the upper deck. Besides disconnection and measurement, double-deck carrier terminal blocks (2002-2667) also provide ground conductor functionality.

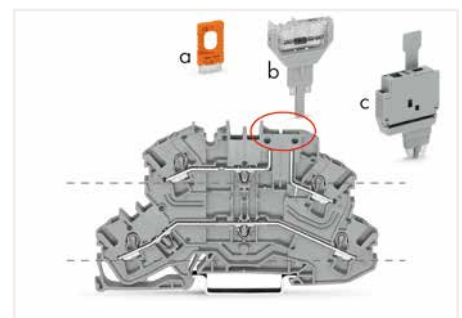

Carrier terminal blocks (2002-2661) have the same design as disconnect terminal blocks. The following components may be used:
- Disconnect plugs (a: 2002-401)
- Pluggable diode (b: 2002-800/1000-411)
- LED module (2002-800/1000-541, no illustration)
- Fuse plug (c: 2004-911)



Double-deck fuse disconnect terminal blocks with a pivoting fuse holder (2002-2611, gray) are compatible with disconnect, carrier, through and ground conductor terminal blocks. The fuse holder is also available with a blown fuse LED indicator (e.g., 2002-2611/1000-541 for 12–30 V).



An end plate for fuse disconnect terminal blocks (shown in orange, 2002-1092) is used for additional protection, preventing the fuse holder from being opened. The fuse cannot be replaced until disconnecting the fuse holder from the power supply.

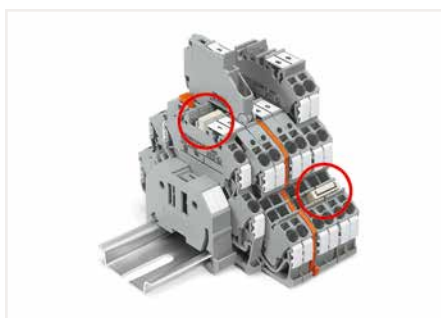

The same profile allows for commoning with double-deck terminal blocks (upper deck) and with triple-deck terminal blocks (lower deck).

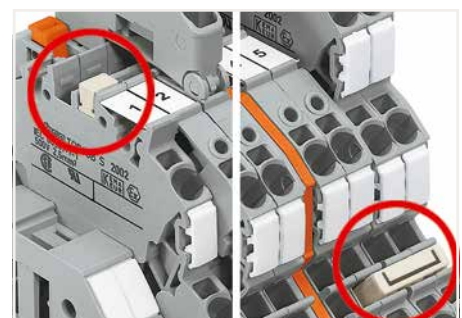

Left picture – Vertical jumper (2002-492)
Right picture – Push-in type jumper bar (2002 Series)

Double-Deck Disconnect Terminal Block, Double-Deck Carrier Terminal Block TOPJOB® S 2.5 (4) mm²; 2002 Series

1

Technical Data	
0.25 ... 2.5 (4) mm ² ①	22 ... 12 AWG
400 V/6 kV/3 ②	300 V, 15 A ③
I _N 16 A	300 V, 15 A ④
Terminal block width: 5.2 mm / 0.205 inch	
 10 ... 12 mm / 0.39 ... 0.47 inch	

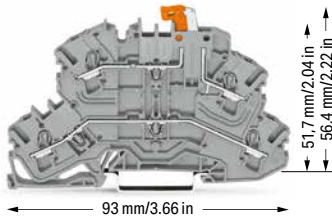

Double-deck disconnect terminal block; with a pivoting knife disconnect; gray

	Item No.	Pack. Unit
○ L/L ⑤	2002-2671 ③	50
○ N/L ⑤	2002-2672 ③	50

Other terminal blocks with the same profile:

Through	2002-2601	Page 84
Fuse	2002-2611	Page 87

Technical Data	
0.25 ... 2.5 (4) mm ² ①	22 ... 12 AWG
400 V/6 kV/3 ②	300 V, 15 A ③
I _N 16 A	300 V, 15 A ④
Terminal block width: 5.2 mm / 0.205 inch	
 10 ... 12 mm / 0.39 ... 0.47 inch	

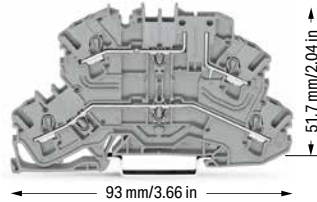

Double-deck carrier terminal block; upper-deck base; gray

	Item No.	Pack. Unit
○ L/L ⑤	2002-2661 ③	50
○ N/L ⑤	2002-2662 ③	50

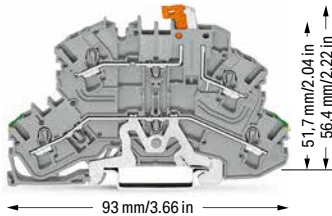

Double-deck disconnect terminal block; with a pivoting knife disconnect; gray

	Item No.	Pack. Unit
○ Shield/L	2002-2678 ③	50

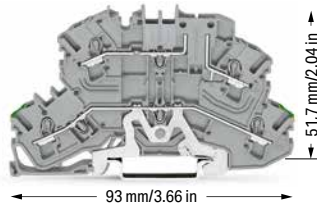

Double-deck carrier terminal block; upper-deck base; gray

	Item No.	Pack. Unit
○ PE/L ⑤	2002-2667 ③	50

① Conductor range: 0.25 ... 4 mm² "s+f-st"; Push-in termination: 1 ... 4 mm² "s" and 1 ... 2.5 mm² "insulated ferrules, 12 mm"
Depending on the conductor characteristic, a conductor with a smaller cross section can also be inserted via push-in termination.

② 400 V = rated voltage
6 kV = rated impulse voltage
3 = pollution degree (see Section 15)

③ Terminal blocks with an Ex mark are suitable for Ex e II applications.
440 V; 14 A (see Section 15)

Please observe the application notes:
Jumpers, from page 174
Testing accessories, page 173
Marking, from page 640

Approvals and corresponding ratings, visit www.wago.com

Accessories; 2002 Series

Appropriate marking systems:
WMB/WMB Inline/Marking strips

End and intermediate plate; 1 mm thick

	orange	2002-2692	100 (25)
	gray	2002-2691	100 (25)

Insulation stop; 5 pcs/strip; 0.25 ... 0.5 mm²

	light gray	2002-171	200 (25)
---	------------	----------	----------

Insulation stop; 5 pcs/strip; 0.75 ... 1 mm²

	dark gray	2002-172	200 (25)
---	-----------	----------	----------

Push-in type jumper bar; insulated; I_N 25 A; light gray

	2-way	2002-402	25
	3-way	2002-403	25
	4-way	2002-404	25
	5-way	2002-405	25
	6-way	2002-406	25
	7-way	2002-407	25
	8-way	2002-408	25
	9-way	2002-409	25
	10-way	2002-410	25

Push-in type jumper bar; insulated; I_N 25 A; light gray

	1 to 3	2002-433	25
	1 to 4	2002-434	25
	1 to 5	2002-435	25
	1 to 6	2002-436	25
	1 to 7	2002-437	25
	1 to 8	2002-438	25
	1 to 9	2002-439	25
	1 to 10	2002-440	25

Double-deck vertical jumper; insulated; I_N 24 A

	light gray	2002-492	100 (25)
	orange	2002-492/000-012	100 (25)

Adjacent jumper for continuous commoning; insulated; I_N 25 A, light gray

	2-way	2002-400	25
---	-------	----------	----

Double-deck marker carrier; pivoting

	gray	2002-121	50 (25)
---	------	----------	---------

Double-Deck Fuse Terminal Block TOPJOB® S

2.5 (4) mm²; 2002 Series

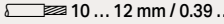
Technical Data	
0.25 ... 2.5 (4) mm ² ①	22 ... 12 AWG
250 V/6 kV/3 ②	300 V, 6.3 A ^{III}
I _N 6.3 A	300 V, 6.3 A ^{III}
Terminal block width: 6.2 mm / 0.244 inch	
 10 ... 12 mm / 0.39 ... 0.47 inch	



Double-deck fuse disconnect terminal block with a pivoting fuse holder; through/fuse terminal block; for 5 x 20 mm glass cartridge fuse; without blown fuse indication; gray
Electrical ratings are given by the fuse.

	Item No.	Pack. Unit
○ L/L ⑤	2002-2611 ⑤	25
○ N/L ⑤	2002-2612 ⑤	25

Other terminal blocks with the same profile:

Through	2002-2601	Page 84
---------	-----------	---------

Accessories; 2002 Series

Appropriate marking systems: WMB/Marking strips

End and intermediate plate; 1 mm thick			
	orange	2002-2692	100 (25)
	gray	2002-2691	100 (25)

End plate for fuse terminal blocks; 2 mm thick			
	orange	2002-1092	100 (25)
	gray	2002-1091	100 (25)

Push-in type jumper bar; insulated; I _N 32 A; light gray			
	2-way	2004-402	25
	3-way	2004-403	25
	4-way	2004-404	25
	5-way	2004-405	25
	6-way	2004-406	25
	7-way	2004-407	25
	8-way	2004-408	25
	9-way	2004-409	25
	10-way	2004-410	25

Push-in type jumper bar; insulated; I _N 32 A; light gray			
	1 to 3	2004-433	25
	1 to 4	2004-434	25
	1 to 5	2004-435	25
	1 to 6	2004-436	25
	1 to 7	2004-437	25
	1 to 8	2004-438	25
	1 to 9	2004-439	25
	1 to 10	2004-440	25

Double-deck vertical jumper; insulated; I _N 24 A			
	light gray	2002-492	100 (25)
	orange	2002-492/000-012	100 (25)

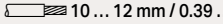
Technical Data	
0.25 ... 2.5 (4) mm ² ①	22 ... 12 AWG
250 V/6 kV/3 ②	30 V, 6.3 A ^{III}
I _N 6.3 A	30 V, 6.3 A ^{III}
Terminal block width: 6.2 mm / 0.244 inch	
 10 ... 12 mm / 0.39 ... 0.47 inch	



Double-deck fuse disconnect terminal block with a pivoting fuse holder; through/fuse terminal block; for 5 x 20 mm glass cartridge fuse; with blown fuse indication by LED; gray
Electrical ratings are given by the fuse and blown fuse indication. Leakage current in case of a blown fuse: LED 2 mA

	Item No.	Pack. Unit
○ 12 ... 30 V ⑤	2002-2611/1000-541 ⑤	25
○ 30 ... 65 V ⑤	2002-2611/1000-542 ⑤	25
○ 230 V ⑤	2002-2611/1000-836 ⑤	25
○ 120 V ⑤	2002-2611/1000-867 ⑤	25

① Conductor range: 0.25 ... 4 mm² "s+f-st"; Push-in termination: 1 ... 4 mm² "s" and 1 ... 2.5 mm² "insulated ferrules, 12 mm"
Depending on the conductor characteristic, a conductor with a smaller cross section can also be inserted via push-in termination.

② 250 V = rated voltage
6 kV = rated impulse voltage
3 = pollution degree (see Section 15)

③ Terminal blocks with an Ex mark are suitable for Ex II applications.
275 V; 6.3 A (see Section 15)

Please observe the application notes:

Jumpers, from page 165

Marking, from page 640

A protective warning marker and an insulation stop must be applied individually. Due to the 6.2 mm width of double-deck terminal blocks with end plates, 2004 Series Push-In Type Jumper Bars must be used.

Approvals and corresponding ratings, visit www.wago.com

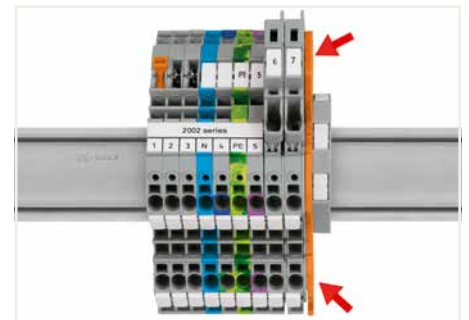

Additionally, an end plate for fuse terminal blocks (e.g., 2002-1092, orange) must be used at the end of an assembly or if there is no adjacent fuse terminal block.

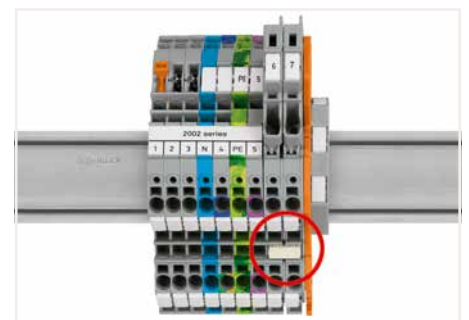

An intermediate plate is supplied with all 6.2 mm wide fused disconnect terminal blocks.
Due to the 6.2 mm width of fuse disconnect terminal blocks with a pivoting fuse holder, 2004 Series Push-In Type Jumper Bars must be used.

Triple-Deck Terminal Block TOPJOB® S

2.5 (4) mm²; 2002 Series

1

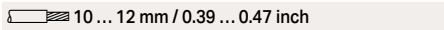
Technical Data	
0.25 ... 2.5 (4) mm ² ①	22 ... 12 AWG
500 V/6 kV/3 ②	300 V, 20 A ③
I _N 24 A (28 A)	600 V, 20 A ④
Terminal block width: 5.2 mm / 0.205 inch	
 10 ... 12 mm / 0.39 ... 0.47 inch	

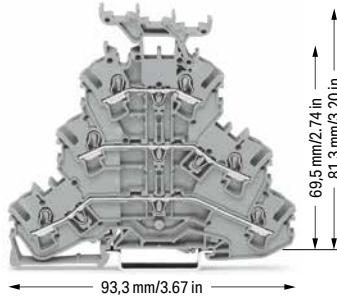

Triple-deck terminal block; through/through/through terminal block; with marker carrier; gray

	Item No.	Pack. Unit
○ L/L/L ⑤	2002-3231 ④	50
○ L/L/N ⑤	2002-3233 ④	50

Triple-deck terminal block; through/through/through terminal block; without marker carrier; gray		
○ L/L/L ⑤	2002-3201 ④	50
○ L/L/N ⑤	2002-3203 ④	50

Other terminal blocks with the same profile:		
Diode	2002-3211/1000-410	Page 166
LED	2002-3221/1000-434	Page 166

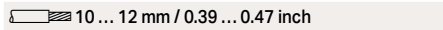
Technical Data	
0.25 ... 2.5 (4) mm ² ①	22 ... 12 AWG
500 V/6 kV/3 ②	300 V, 20 A ③
I _N 24 A (28 A)	600 V, 20 A ④
Terminal block width: 5.2 mm / 0.205 inch	
 10 ... 12 mm / 0.39 ... 0.47 inch	

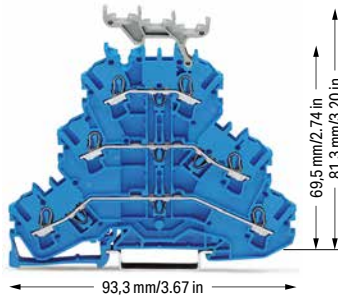

Triple-deck terminal block; through/through/through terminal block; with marker carrier; blue

	Item No.	Pack. Unit
● N/N/N ⑤	2002-3234 ③ ④	50

Triple-deck terminal block; through/through/through terminal block; without marker carrier; blue		
● N/N/N ⑤	2002-3204 ③ ④	50

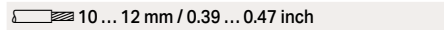
Technical Data	
0.25 ... 2.5 (4) mm ² ①	22 ... 12 AWG
500 V/6 kV/3 ②	300 V, 20 A ③
I _N 24 A (28 A)	600 V, 20 A ④
Terminal block width: 5.2 mm / 0.205 inch	
 10 ... 12 mm / 0.39 ... 0.47 inch	

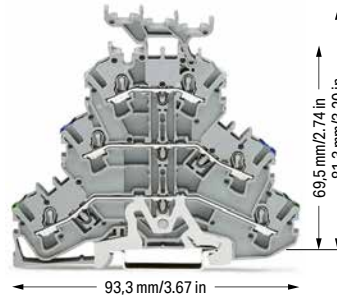

Triple-deck terminal block; ground conductor/through/through terminal block; with marker carrier; gray

	Item No.	Pack. Unit
○ PE/N/L ⑤	2002-3247 ④	50
○ PE/L/L ⑤	2002-3257 ④	50

Triple-deck terminal block; ground conductor/through/through terminal block; without marker carrier; gray		
○ PE/N/L ⑤	2002-3217 ④	50
○ PE/L/L ⑤	2002-3227 ④	50

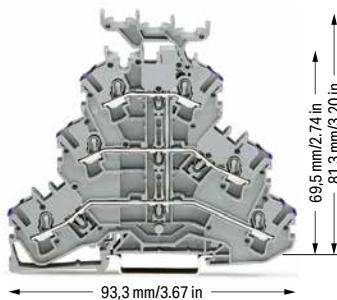

Triple-deck terminal block; 6-conductor through terminal block; with marker carrier; internally commoned; violet conductor entry; gray

	Item No.	Pack. Unit
○ L ⑤	2002-3238 ④	50

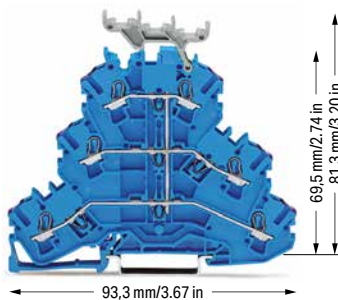

Triple-deck terminal block; 6-conductor through terminal block; with marker carrier; internally commoned; violet conductor entry; blue

	Item No.	Pack. Unit
● N ⑤	2002-3239 ③ ④	50

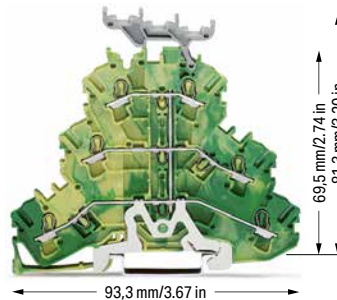

Triple-deck terminal block; 6-conductor ground terminal block; with marker carrier; internally commoned; green-yellow

	Item No.	Pack. Unit
● PE ⑤	2002-3237 ④	50

Triple-deck terminal block; 6-conductor through terminal block; without marker carrier; internally commoned; violet conductor entry; gray		
○ L ⑤	2002-3208 ④	50

Triple-deck terminal block; 6-conductor through terminal block; without marker carrier; internally commoned; violet conductor entry; blue		
● N ⑤	2002-3209 ③ ④	50

Triple-deck terminal block; 6-conductor ground terminal block; without marker carrier; internally commoned; green-yellow		
● PE ⑤	2002-3207 ④	50

Technical Data

0.25 ... 2.5 (4) mm ² ①	22 ... 12 AWG
500 V/6 kV/3 ②	300 V, 20 A ③
I _N 24 A (28 A)	600 V, 20 A ④
Terminal block width: 5.2 mm / 0.205 inch	
10 ... 12 mm / 0.39 ... 0.47 inch	

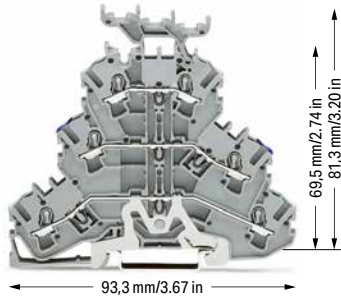

Triple-deck terminal block; shield/through/through terminal block; with marker carrier; gray

	Item No.	Pack. Unit
○ Shield/N/L	2002-3248	50
○ Shield/L/L	2002-3258	50

Triple-deck terminal block; shield/through/through terminal block; without marker carrier; gray

○ Shield/N/L	2002-3218	50
○ Shield/L/L	2002-3228	50

- Conductor range: 0.25 ... 4 mm² "s+f-st"; Push-in termination: 1 ... 4 mm² "s" and 1 ... 2.5 mm² "insulated ferrules, 12 mm"
Depending on the conductor characteristic, a conductor with a smaller cross section can also be inserted via push-in termination.
- 500 V = rated voltage
6 kV = rated impulse voltage
3 = pollution degree (see Section 15)
- Terminal blocks with a blue insulated housing are suitable for Ex i applications.
- Terminal blocks with an Ex mark are suitable for Ex e II applications.
440 V, 19 A
17 A jumper (see Section 15)

Please observe the application notes:
Jumpers, from page 174
Testing accessories, page 173
Marking, from page 640

Approvals and corresponding ratings, visit www.wago.com

Accessories; 2002 Series

Appropriate marking systems:
WMB/WMB Inline/Marking strips

End and intermediate plate; 0.8 mm thick

	orange	2002-3292	100 (25)
	gray	2002-3291	100 (25)

Insulation stop; 5 pcs/strip; 0.25 ... 0.5 mm²

	light gray	2002-171	200 (25)
---	------------	----------	----------

Insulation stop; 5 pcs/strip; 0.75 ... 1 mm²

	dark gray	2002-172	200 (25)
---	-----------	----------	----------

Push-in type jumper bar; insulated; I_N 25 A; light gray

	2-way	2002-402	25
	3-way	2002-403	25
	4-way	2002-404	25
	5-way	2002-405	25
	6-way	2002-406	25
	7-way	2002-407	25
	8-way	2002-408	25
	9-way	2002-409	25
	10-way	2002-410	25

Push-in type jumper bar; insulated; I_N 25 A; light gray

	1 to 3	2002-433	25
	1 to 4	2002-434	25
	1 to 5	2002-435	25
	1 to 6	2002-436	25
	1 to 7	2002-437	25
	1 to 8	2002-438	25
	1 to 9	2002-439	25
	1 to 10	2002-440	25

Double-deck vertical jumper; insulated; I_N 24 A

	light gray	2002-492	100 (25)
	orange	2002-492/000-012	100 (25)

Triple-deck vertical jumper; insulated; I_N 24 A

	light gray	2002-493	100 (25)
---	------------	----------	----------

Triple-deck marker carrier; pivoting

	gray	2002-131	50 (25)
---	------	----------	---------



Triple-deck vertical jumpers (2002-493) connect the three levels of triple-deck terminal blocks.



Combination of multilevel terminal blocks

Quadruple-Deck Rail-Mount Terminal Block for Wiring of Electric Motors TOPJOB® S

2.5 (4) mm²; 2002 Series

1

Technical Data

0.25 ... 2.5 (4) mm ² ①	22 ... 12 AWG
800 V/8 kV/3 ②	600 V, 20 A, $\sqrt{3}$ ③
I _N 20 A (25 A)	600 V, 20 A ④

Terminal block width: 5.2 mm / 0.205 inch

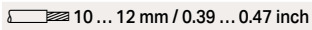
 10 ... 12 mm / 0.39 ... 0.47 inch

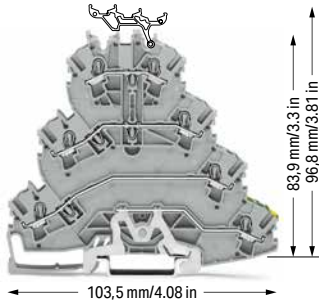

Quadruple-deck rail-mount terminal block; electric motor wiring rail-mount terminal block; without marker carrier; gray

Item No.	Pack. Unit
L1 - L2 - L3 - PE ⑤ 2002-4127 ⑥	25

Item No.	Pack. Unit
L1 - L2 - L3 - PE ⑤ 2002-4157 ⑥	25

Technical Data

0.25 ... 2.5 (4) mm ² ①	22 ... 12 AWG
800 V/8 kV/3 ②	600 V, 20 A, $\sqrt{3}$ ③
I _N 20 A (25 A)	600 V, 20 A ④

Terminal block width: 5.2 mm / 0.205 inch

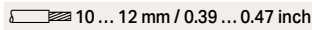
 10 ... 12 mm / 0.39 ... 0.47 inch

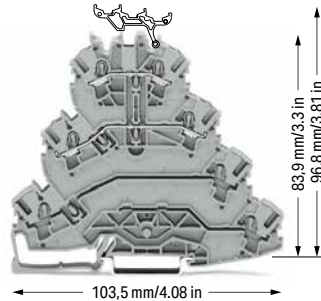

Quadruple-deck rail-mount terminal block; electric motor wiring rail-mount terminal block; with marker carrier; gray

Item No.	Pack. Unit
L1 - L2 ⑤ 2002-4111 ⑥	25

Item No.	Pack. Unit
L1 - L2 ⑤ 2002-4141 ⑥	25

Technical Data

0.25 ... 2.5 (4) mm ² ①	22 ... 12 AWG
800 V/8 kV/3 ②	600 V, 20 A, $\sqrt{3}$ ③
I _N 20 A (25 A)	600 V, 20 A ④

Terminal block width: 5.2 mm / 0.205 inch

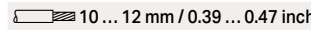
 10 ... 12 mm / 0.39 ... 0.47 inch

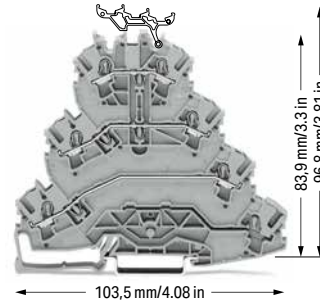

Quadruple-deck rail-mount terminal block; electric motor wiring rail-mount terminal block; without marker carrier; gray



Item No.	Pack. Unit
L1 - L2 - L3 ⑤ 2002-4101 ⑥	25

Item No.	Pack. Unit
L1 - L2 - L3 ⑤ 2002-4131 ⑥	25

Accessories; 2002 Series

Appropriate marking systems: WMB/WMB Inline/Marking strips

End and intermediate plate; 1 mm thick

 orange	2002-4192	100 (25)
 gray	2002-4191	100 (25)

Insulation stop; 5 pcs/strip; 0.25 ... 0.5 mm²

 light gray	2002-171	200 (25)
--	----------	----------



Insulation stop; 5 pcs/strip; 0.75 ... 1 mm²

 dark gray	2002-172	200 (25)
---	----------	----------









Protective warning marker; with black high-voltage symbol; for 5 terminal blocks

 yellow	2002-115	100 (25)
--	----------	----------









Lockout cap; for conductor entry and operating slot

 orange	2002-192	25
 gray	2002-191	25
 blue	2002-194	25

Push-in type jumper bar; insulated; I_N 25 A; light gray

 2-way	2002-402	25
 3-way	2002-403	25
 4-way	2002-404	25
 5-way	2002-405	25
 6-way	2002-406	25
 7-way	2002-407	25
 8-way	2002-408	25
 9-way	2002-409	25
 10-way	2002-410	25

Push-in type jumper bar; insulated; I_N 25 A; light gray

 1 to 3	2002-433	25
 1 to 4	2002-434	25
 1 to 5	2002-435	25
 1 to 6	2002-436	25
 1 to 7	2002-437	25
 1 to 8	2002-438	25
 1 to 9	2002-439	25
 1 to 10	2002-440	25











Delta jumper; insulated; I_N = I_N terminal block; light gray

 1-2 3-4 5-6	2002-406/020-000	25
---	------------------	----

Star point jumper; insulated; I_N = I_N terminal block; light gray

 1-3-5	2002-405/011-000	25
---	------------------	----



Staggered jumper; insulated; I_N 25 A; light gray

 2-way	2002-472	25
 3-way	2002-473	25
 4-way	2002-474	25
 5-way	2002-475	25
 6-way	2002-476	25
 7-way	2002-477	25
 8-way	2002-478	25
 9-way	2002-479	25
 10-way	2002-480	25
 11-way	2002-481	25
 12-way	2002-482	25



Adjacent jumper for continuous commoning; insulated; I_N 25 A, light gray

 5-way	2002-400	25
---	----------	----

Adjacent jumper for continuous commoning; insulated; I_N 25 A; 1 to 3

 light gray	2002-423	25
 red	2002-423/000-005	25
 blue	2002-423/000-006	25

Push-in type wire jumper; insulated; 1.5 mm² conductor cross-section; I_N 18 A

 L = 60 mm	2009-412	100 (10)
 L = 110 mm	2009-414	100 (10)
 L = 250 mm	2009-416	100 (10)

Marking strip; plain; 11 mm wide; 50 m reel

 white	2009-110	1
---	----------	---

WMB Inline, plain; 1,500 WMB markers (5 mm)/reel; 5 ... 5.2 mm stretchable

 white	2009-115	1
---	----------	---

WMB marking card; white; 10 strips with 10 markers/card; 5 ... 5.2 mm stretchable

 plain	793-5501	5
---	----------	---

Triple-deck marker carrier; pivoting

 gray	2002-131	50 (25)
--	----------	---------

❶ Conductor range: 0.25 ... 4 mm² "s+f-st";
Push-in termination: 1 ... 4 mm² "s" and 1 ... 2.5 mm²
"insulated ferrules, 12 mm"
Depending on the conductor characteristic, a conductor with a smaller cross section can also be inserted via push-in termination.

❷ 800 V = rated voltage
8 kV = rated impulse voltage
3 = pollution degree
(see Section 15)

❸ Terminal blocks with an Ex mark are suitable for Ex e II applications.
440 V, 19 A
17 A jumper
(see Section 15)

Please observe the application notes:
Jumpers, from page 174
Testing accessories, page 173
Marking, from page 640

Approvals and corresponding ratings,
visit www.wago.com



Creating spacer housings for electric motor wiring rail-mount terminal blocks via lockout caps (2002-192) for conductor entry and operating slot.

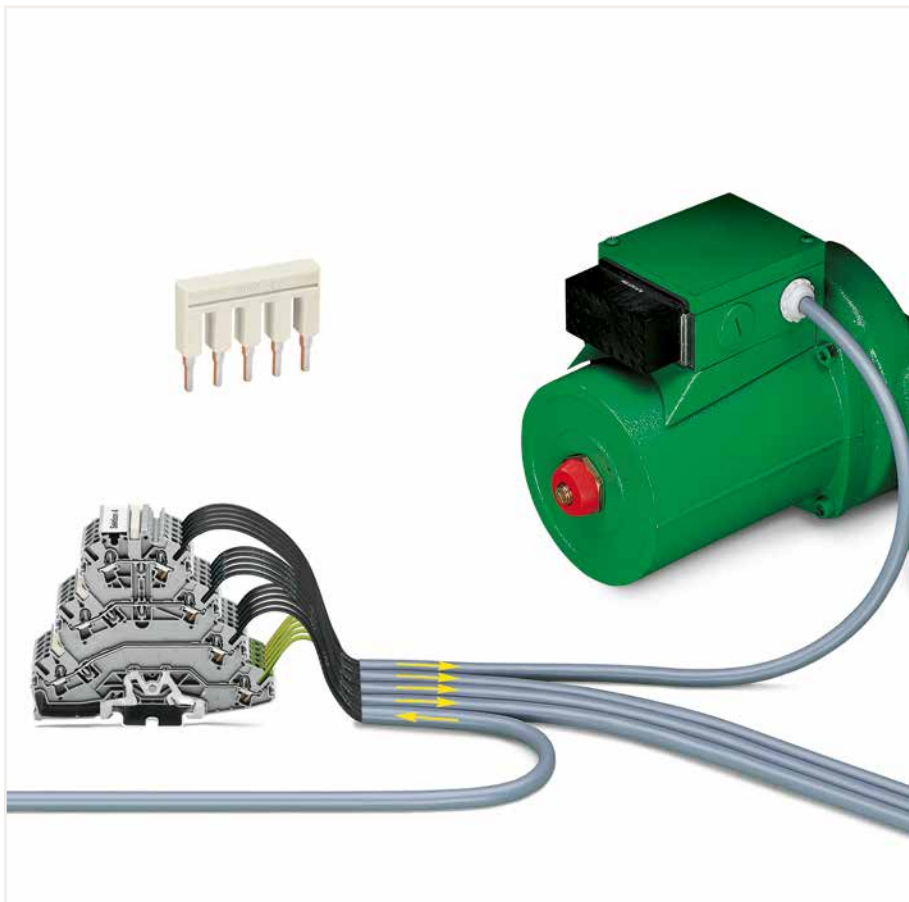

In addition to rail-mount terminal blocks for electric motor wiring, special versions are also available.

- Version without ground contact and only two potentials:
These terminal blocks were custom designed to support additional functions, such as engine brakes or temperature sensors. Sharing a common profile, this terminal block version can be put next to the appropriate electric motor wiring terminal block without using intermediate plates. That makes the rail assembly easier to understand and wire. This also prevents wiring errors as no conductor entry is unused.
- Version without ground contact and with three potentials:
Clearly designated clamping units are the primary advantage to this terminal block design. When using devices with protective insulation, for example, there are no open ground clamping units that could create confusion.



Testing with voltage tester.



Marking clamping points via WMB Multi Marking System.
Group marking via marking strips (Item No. 709-177).

Disconnect/Test Terminal Block, Fuse Terminal Block, Carrier Terminal Block, Through Terminal Block TOPJOB® S; with Push-Button 2.5 (4) mm²; 2202 Series

1

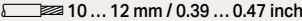
Technical Data	
0.25 ... 2.5 (4) mm ² ①	22 ... 12 AWG
400 V/6 kV/3 ②	300 V, 15 A VA
I _N 16 A	300 V, 15 A AE
Terminal block width: 5.2 mm / 0.205 inch	
 10 ... 12 mm / 0.39 ... 0.47 inch	

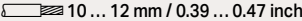
Technical Data	
0.25 ... 2.5 (4) mm ² ①	22 ... 12 AWG
400 V/6 kV/3 ②	300 V, 10 A VA
I _N 10 A ③	300 V, 10 A AE
Terminal block width: 5.2 mm / 0.205 inch	
 10 ... 12 mm / 0.39 ... 0.47 inch	

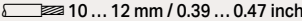
Technical Data	
0.25 ... 2.5 (4) mm ² ①	22 ... 12 AWG
400 V/6 kV/3 ②	300 V, 15 A VA
I _N 16 A	300 V, 15 A AE
Terminal block width: 5.2 mm / 0.205 inch	
 10 ... 12 mm / 0.39 ... 0.47 inch	

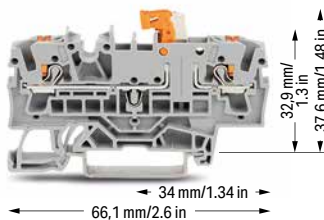

2-conductor disconnect/test terminal block; with push-button; with test point; orange disconnect link

Color	Item No.	VPE
gray	2202-1671	50
blue	2202-1674	50
orange	2202-1672	50

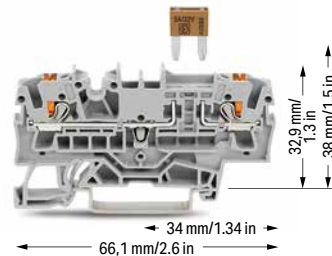

2-conductor fuse terminal block; with push-button; for mini-automotive blade-style fuse; with test point
Electrical ratings are given by the fuse. Blade-style fuses: Observe touch-proof protection for 42 V and higher voltages!

Color	Item No.	VPE
gray	2202-1681	50

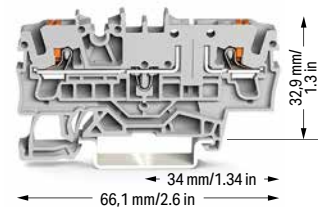

2-conductor carrier terminal block; with push-button; with test point

Color	Item No.	VPE
gray	2202-1661	50

Accessories; item-specific

Disconnect plug for carrier terminal blocks; suitable when using a carrier terminal block as disconnect terminal block

	orange	2002-401	100 (25)
---	--------	----------	----------

Accessories; 2202 Series

Appropriate marking systems: WMB/WMB Inline/Marking strips

End and intermediate plate; 1 mm thick			
	orange	2002-1692	100 (25)
	gray	2002-1691	100 (25)

Insulation stop; 5 pcs/strip; 0.25 ... 0.5 mm ²			
	light gray	2002-171	200 (25)

Insulation stop; 5 pcs/strip; 0.75 ... 1 mm ²			
	dark gray	2002-172	200 (25)

Push-in type jumper bar; insulated; I _N 25 A; light gray			
	2-way	2002-402	25
	3-way	2002-403	25
	4-way	2002-404	25
	5-way	2002-405	25
	6-way	2002-406	25
	7-way	2002-407	25
	8-way	2002-408	25
	9-way	2002-409	25
	10-way	2002-410	25

Push-in type jumper bar; insulated; I _N 25 A; light gray			
	1 to 3	2002-433	25
	1 to 4	2002-434	25
	1 to 5	2002-435	25
	1 to 6	2002-436	25
	1 to 7	2002-437	25
	1 to 8	2002-438	25
	1 to 9	2002-439	25
	1 to 10	2002-440	25

Delta jumper; insulated; I _N = I _N terminal block; light gray			
	1-2-3-4-5-6	2002-406/020-000	25

Star point jumper; insulated; I _N = I _N terminal block; light gray			
	1-3-5	2002-405/011-000	25

Adjacent jumper for continuous commoning; insulated; I _N 25 A; light gray			
	2-way	2002-400	25

Adjacent jumper for continuous commoning; insulated; I _N 25 A; 1 to 3			
	light gray	2002-423	25
	red	2002-423/000-005	25
	blue	2002-423/000-006	25

Staggered jumper; insulated; I _N 25 A; light gray			
	2-way	2002-472	25
	3-way	2002-473	25
	4-way	2002-474	25
	5-way	2002-475	25
	6-way	2002-476	25
	7-way	2002-477	25
	8-way	2002-478	25
	9-way	2002-479	25
	10-way	2002-480	25
	11-way	2002-481	25
	12-way	2002-482	25

Customized staggered jumper; insulated; with contact lugs broken off at the factory and circuit printing; I _N 25 A; light gray			
	1-3	2002-473/011-000	25
	1-3-5	2002-475/011-000	25
	1-3-5-7	2002-477/011-000	25
	1-3-5-7-9	2002-479/011-000	25
	1-3-5-7-9-11	2002-481/011-000	25

Push-in type wire jumper; insulated; 1.5 mm ² conductor cross-section; I _N 18 A			
	L = 60 mm	2009-412	100 (10)
	L = 110 mm	2009-414	100 (10)
	L = 250 mm	2009-416	100 (10)

Technical Data

0.25 ... 2.5 (4) mm ² ①	22 ... 12 AWG
400 V/6 kV/3 ②	300 V, 15 A
I _N 16 A	300 V, 15 A
Terminal block width: 5.2 mm / 0.205 inch	
10 ... 12 mm / 0.39 ... 0.47 inch	

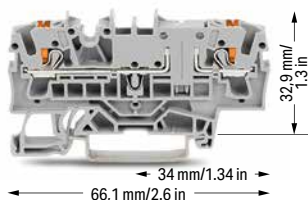

2-conductor through terminal block; with push-button; with test point; same profile as 2-conductor disconnect terminal block

Color	Item No.	VPE
gray	2202-1601	50
blue	2202-1604	50
orange	2202-1602	50

Other terminal blocks with the same profile:

Fuse	2202-1611	Page 102
------	-----------	----------

① Conductor range: 0.25 ... 4 mm² "s+f-st";
Push-in termination: 1 ... 4 mm² "s" and 1 ... 2.5 mm² "insulated ferrules, 12 mm"
Depending on the conductor characteristic, a conductor with a smaller cross section can also be inserted via push-in termination.

② 400 V = rated voltage
6 kV = rated impulse voltage
3 = pollution degree (see Section 15)

③ Observe touch-proof protection for 42 V and higher voltages!
• 10 A (individual arrangement)
• 5 A (block arrangement)

Blade-style fuses are not offered by WAGO.

Please observe the application notes:
Jumpers, from page 174
Testing accessories, from page 169
Marking, from page 640

Approvals and corresponding ratings, visit www.wago.com

Modular connector; snaps together; for jumper contact slot

	gray	2002-511	100 (25)
--	------	----------	----------

Spacer module; snaps together; bridges commoned terminal blocks

	gray	2002-549	100 (25)
--	------	----------	----------

Marking strip; plain; 11 mm wide; 50 m reel

	white	2009-110	1
--	-------	----------	---

WMB Inline; plain; 1,500 WMB markers (5 mm)/reel; stretchable 5 ... 5.2 mm

	white	2009-115	1
--	-------	----------	---

WMB marker card; white; 10 strips with 10 markers/card; stretchable 5 ... 5.2 mm

	plain	793-5501	5
--	-------	----------	---

Disconnect/Test Terminal Block, Fuse Terminal Block, Carrier Terminal Block, Through Terminal Block, Ground Conductor Terminal Block TOPJOB® S; with Push-Button 2.5 (4) mm²; 2202 Series

1

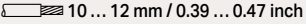
Technical Data	
0.25 ... 2.5 (4) mm ² ①	22 ... 12 AWG
400 V/6 kV/3 ②	300 V, 15 A \overline{VA}
I _N 16 A	300 V, 15 A \oplus
Terminal block width: 5.2 mm / 0.205 inch	
 10 ... 12 mm / 0.39 ... 0.47 inch	

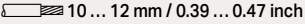
Technical Data	
0.25 ... 2.5 (4) mm ² ①	22 ... 12 AWG
400 V/6 kV/3 ②	300 V, 10 A \overline{VA}
I _N 10 A ③	300 V, 10 A \oplus
Terminal block width: 5.2 mm / 0.205 inch	
 10 ... 12 mm / 0.39 ... 0.47 inch	

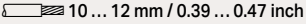
Technical Data	
0.25 ... 2.5 (4) mm ² ①	22 ... 12 AWG
400 V/6 kV/3 ②	300 V, 15 A \overline{VA}
I _N 16 A	300 V, 15 A \oplus
Terminal block width: 5.2 mm / 0.205 inch	
 10 ... 12 mm / 0.39 ... 0.47 inch	

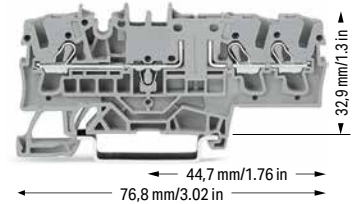
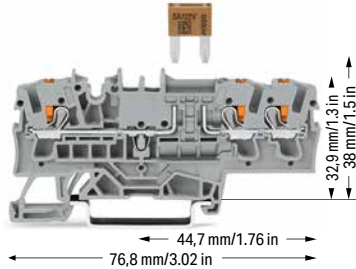
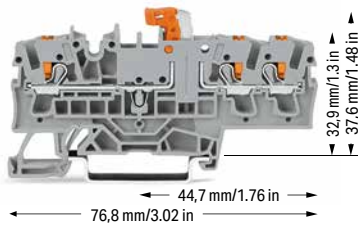

3-conductor disconnect/test terminal block; with push-button; with test point; orange disconnect link

3-conductor fuse terminal block; with push-button; for mini-automotive blade-style fuse; with test point
Electrical ratings are given by the fuse. Blade-style fuses: Observe touch-proof protection for 42 V and higher voltages!

3-conductor carrier terminal block; with push-button; with test point

Color	Item No.	VPE
gray	2202-1771	50
blue	2202-1774	50
orange	2202-1772	50

Color	Item No.	VPE
gray	2202-1781	50



Color	Item No.	VPE
gray	2202-1761	50

Accessories; item-specific
Disconnect plug for carrier terminal blocks; suitable when using a carrier terminal block as disconnect terminal block

	orange	2002-401	100 (25)
---	--------	----------	----------









Accessories; 2202 Series









Appropriate marking systems: WMB/WMB Inline/Marking strips

End and intermediate plate; 1 mm thick			
	orange	2002-1792	100 (25)
	gray	2002-1791	100 (25)

Insulation stop; 5 pcs/strip; 0.25 ... 0.5 mm ²			
	light gray	2002-171	200 (25)

Insulation stop; 5 pcs/strip; 0.75 ... 1 mm ²			
	dark gray	2002-172	200 (25)











Push-in type jumper bar; insulated; I _N 25 A; light gray			
	2-way	2002-402	25
	3-way	2002-403	25
	4-way	2002-404	25
	5-way	2002-405	25
	6-way	2002-406	25
	7-way	2002-407	25
	8-way	2002-408	25
	9-way	2002-409	25
	10-way	2002-410	25





Push-in type jumper bar; insulated; I _N 25 A; light gray			
	1 to 3	2002-433	25
	1 to 4	2002-434	25
	1 to 5	2002-435	25
	1 to 6	2002-436	25
	1 to 7	2002-437	25
	1 to 8	2002-438	25
	1 to 9	2002-439	25
	1 to 10	2002-440	25



Star point jumper; insulated; I _N = I _N terminal block; light gray			
	1-3-5	2002-405/011-000	25

Delta jumper; insulated; I _N = I _N terminal block; light gray			
	1-2 3-4 5-6	2002-406/020-000	25

Adjacent jumper for continuous commoning; insulated; I _N 25 A; light gray			
	2-way	2002-400	25

Staggered jumper; insulated; I _N 25 A; light gray			
	2-way	2002-472	25
	3-way	2002-473	25
	4-way	2002-474	25
	5-way	2002-475	25
	6-way	2002-476	25
	7-way	2002-477	25
	8-way	2002-478	25
	9-way	2002-479	25
	10-way	2002-480	25
	11-way	2002-481	25
	12-way	2002-482	25

Customized staggered jumper; insulated; with contact lugs broken off at the factory and circuit printing; I _N 25 A; light gray			
	1-3	2002-473/011-000	25
	1-3-5	2002-475/011-000	25
	1-3-5-7	2002-477/011-000	25
	1-3-5-7-9	2002-479/011-000	25
	1-3-5-7-9-11	2002-481/011-000	25

Adjacent jumper for continuous commoning; insulated; I _N 25 A; 1 to 3			
	light gray	2002-423	25
	red	2002-423/000-005	25
	blue	2002-423/000-006	25

Technical Data

0.25 ... 2.5 (4) mm ² ①	22 ... 12 AWG
400 V/6 kV/3 ②	300 V, 15 A
I _N 16 A	300 V, 15 A
Terminal block width: 5.2 mm / 0.205 inch	
10 ... 12 mm / 0.39 ... 0.47 inch	

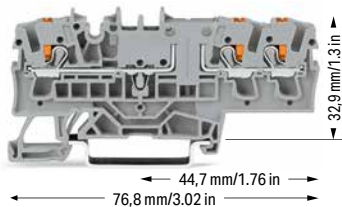

3-conductor through terminal block; with push-button; with test point; same profile as 3-conductor disconnect terminal block

Color	Item No.	VPE
gray	2202-1701	50
blue	2202-1704	50
orange	2202-1702	50

3-conductor ground terminal block; with push-button; with test point

green-yellow	2202-1707	50
--------------	-----------	----

Other terminal blocks with the same profile:

Fuse	2202-1711	Page 102
------	-----------	----------

① Conductor range: 0.25 ... 4 mm² "s+f-st";
Push-in termination: 1 ... 4 mm² "s" and 1 ... 2.5 mm² "insulated ferrules, 12 mm"
Depending on the conductor characteristic, a conductor with a smaller cross section can also be inserted via push-in termination.

② 400 V = rated voltage
6 kV = rated impulse voltage
3 = pollution degree
(see Section 15)

③ Observe touch-proof protection for 42 V and higher voltages!
• 10 A (individual arrangement)
• 5 A (block arrangement)

Blade-style fuses are not offered by WAGO.

Please observe the application notes:
Jumpers, from page 174
Testing accessories, from page 169
Marking, from page 640

Approvals and corresponding ratings, visit www.wago.com

Accessories; 2202 Series

Appropriate marking systems:
WMB/WMB Inline/Marking strips

Marking strip; plain; 11 mm wide; 50 m reel

white	2009-110	1
-------	----------	---

WMB Inline; plain; 1,500 WMB markers (5 mm)/reel; stretchable 5 ... 5.2 mm

white	2009-115	1
-------	----------	---

WMB marker card; white; 10 strips with 10 markers/card; stretchable 5 ... 5.2 mm

plain	793-5501	5
-------	----------	---

Push-in type wire jumper; insulated; 1.5 mm² conductor cross-section; I_N 18 A

L = 60 mm	2009-412	100 (10)
L = 110 mm	2009-414	100 (10)
L = 250 mm	2009-416	100 (10)

Modular connector; snaps together; for jumper contact slot

gray	2002-511	100 (25)
------	----------	----------

Spacer module; snaps together; bridges commoned terminal blocks

gray	2002-549	100 (25)
------	----------	----------

Disconnect/Test Terminal Block, Fuse Terminal Block, Carrier Terminal Block, Through Terminal Block TOPJOB® S; with Push-Button 2.5 (4) mm²; 2202 Series

1

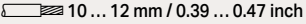
Technical Data	
0.25 ... 2.5 (4) mm ² ①	22 ... 12 AWG
400 V/6 kV/3 ②	300 V, 15 A ③
I _N 16 A	300 V, 15 A ④
Terminal block width: 5.2 mm / 0.205 inch	
 10 ... 12 mm / 0.39 ... 0.47 inch	

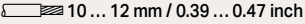
Technical Data	
0.25 ... 2.5 (4) mm ² ①	22 ... 12 AWG
400 V/6 kV/3 ②	300 V, 10 A ③
I _N 10 A ④	300 V, 10 A ④
Terminal block width: 5.2 mm / 0.205 inch	
 10 ... 12 mm / 0.39 ... 0.47 inch	

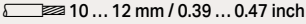
Technical Data	
0.25 ... 2.5 (4) mm ² ①	22 ... 12 AWG
400 V/6 kV/3 ②	300 V, 15 A ③
I _N 16 A	300 V, 15 A ④
Terminal block width: 5.2 mm / 0.205 inch	
 10 ... 12 mm / 0.39 ... 0.47 inch	

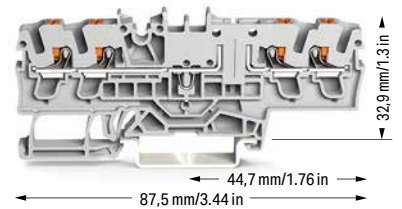
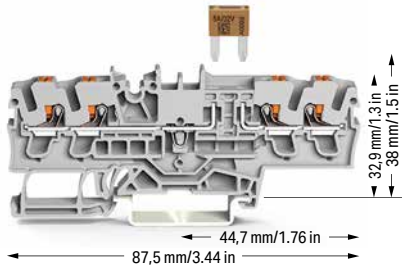
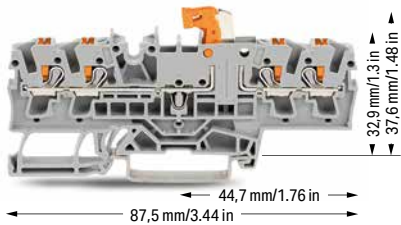

4-conductor disconnect/test terminal block; with push-button; with test point; orange disconnect link

4-conductor fuse terminal block; with push-button; for mini-automotive blade-style fuse; with test point
Electrical ratings are given by the fuse. Blade-style fuses: Observe touch-proof protection for 42 V and higher voltages!

4-conductor carrier terminal block; with push-button; with test point

Color	Item No.	VPE
gray	2202-1871	50
blue	2202-1874	50
orange	2202-1872	50

Color	Item No.	VPE
gray	2202-1881	50

Color	Item No.	VPE
gray	2202-1861	50

Accessories; item-specific

Disconnect plug for carrier terminal blocks; suitable when using a carrier terminal block as disconnect terminal block

	orange	2002-401	100 (25)
---	--------	----------	----------

Accessories; 2202 Series

Appropriate marking systems: WMB/WMB Inline/Marking strips

End and intermediate plate; 1 mm thick			
	orange	2002-1892	100 (25)
	gray	2002-1891	100 (25)

Insulation stop; 5 pcs/strip; 0.25 ... 0.5 mm ²			
	light gray	2002-171	200 (25)

Insulation stop; 5 pcs/strip; 0.75 ... 1 mm ²			
	dark gray	2002-172	200 (25)

Push-in type jumper bar; insulated; I _N 25 A; light gray			
	2-way	2002-402	25
	3-way	2002-403	25
	4-way	2002-404	25
	5-way	2002-405	25
	6-way	2002-406	25
	7-way	2002-407	25
	8-way	2002-408	25
	9-way	2002-409	25
	10-way	2002-410	25

Push-in type jumper bar; insulated; I _N 25 A; light gray			
	1 to 3	2002-433	25
	1 to 4	2002-434	25
	1 to 5	2002-435	25
	1 to 6	2002-436	25
	1 to 7	2002-437	25
	1 to 8	2002-438	25
	1 to 9	2002-439	25
	1 to 10	2002-440	25

Delta jumper; insulated; I _N = I _N terminal block; light gray			
	1-2-3-4-5-6	2002-406/020-000	25

Star point jumper; insulated; I _N = I _N terminal block; light gray			
	1-3-5	2002-405/011-000	25

Adjacent jumper for continuous commoning; insulated; I _N 25 A; light gray			
	2-way	2002-400	25

Adjacent jumper for continuous commoning; insulated; I _N 25 A; 1 to 3			
	light gray	2002-423	25
	red	2002-423/000-005	25
	blue	2002-423/000-006	25

Staggered jumper; insulated; I _N 25 A; light gray			
	2-way	2002-472	25
	3-way	2002-473	25
	4-way	2002-474	25
	5-way	2002-475	25
	6-way	2002-476	25
	7-way	2002-477	25
	8-way	2002-478	25
	9-way	2002-479	25
	10-way	2002-480	25
	11-way	2002-481	25
	12-way	2002-482	25

Customized staggered jumper; insulated; with contact lugs broken off at the factory and circuit printing; I _N 25 A; light gray			
	1-3	2002-473/011-000	25
	1-3-5	2002-475/011-000	25
	1-3-5-7	2002-477/011-000	25
	1-3-5-7-9	2002-479/011-000	25
	1-3-5-7-9-11	2002-481/011-000	25

Push-in type wire jumper; insulated; 1.5 mm ² conductor cross-section; I _N 18 A			
	L = 60 mm	2009-412	100 (10)
	L = 110 mm	2009-414	100 (10)
	L = 250 mm	2009-416	100 (10)

Technical Data

0.25 ... 2.5 (4) mm ² ①	22 ... 12 AWG
400 V/6 kV/3 ②	300 V, 15 A
I _N 16 A	300 V, 15 A
Terminal block width: 5.2 mm / 0.205 inch	
10 ... 12 mm / 0.39 ... 0.47 inch	

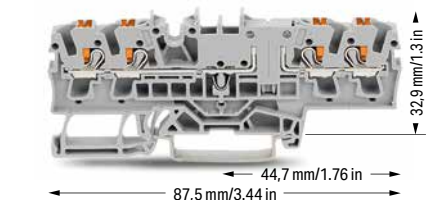

4-conductor through terminal block; with push-button; with test point; same profile as 4-conductor disconnect terminal block

Color	Item No.	VPE
gray	2202-1801	50
blue	2202-1804	50
orange	2202-1802	50

Other terminal blocks with the same profile:

Fuse	2202-1811	Page 103
------	-----------	----------

① Conductor range: 0.25 ... 4 mm² "s+f-st";
 Push-in termination: 1 ... 4 mm² "s" and 1 ... 2.5 mm² "insulated ferrules, 12 mm"
 Depending on the conductor characteristic, a conductor with a smaller cross section can also be inserted via push-in termination.

② 400 V = rated voltage
 6 kV = rated impulse voltage
 3 = pollution degree
 (see Section 15)

③ Observe touch-proof protection for 42 V and higher voltages!
 • 10 A (individual arrangement)
 • 5 A (block arrangement)

Blade-style fuses are not offered by WAGO.

Please observe the application notes:
 Jumpers, from page 174
 Testing accessories, from page 169
 Marking, from page 640

Approvals and corresponding ratings, visit www.wago.com

Modular connector; snaps together; for jumper contact slot

	gray	2002-511	100 (25)
--	------	----------	----------

Spacer module; snaps together; bridges commoned terminal blocks

	gray	2002-549	100 (25)
--	------	----------	----------

Marking strip; plain; 11 mm wide; 50 m reel

	white	2009-110	1
--	-------	----------	---

WMB Inline; plain; 1,500 WMB markers (5 mm)/reel; stretchable 5 ... 5.2 mm

	white	2009-115	1
--	-------	----------	---

WMB marker card; white; 10 strips with 10 markers/card; stretchable 5 ... 5.2 mm

	plain	793-5501	5
--	-------	----------	---

Disconnect/Test Terminal Block, Fuse Terminal Block, Carrier Terminal Block, Through Terminal Block, Ground Conductor Terminal Block TOPJOB® S; with Push-Button; with Additional Jumper Slot 2.5 (4) mm²; 2202 Series

1

Technical Data	
0.25 ... 2.5 (4) mm ² ①	22 ... 12 AWG
400 V/6 kV/3 ②	300 V, 15 A ③
I _N 16 A	300 V, 15 A ④
Terminal block width: 5.2 mm / 0.205 inch	
10 ... 12 mm / 0.39 ... 0.47 inch	

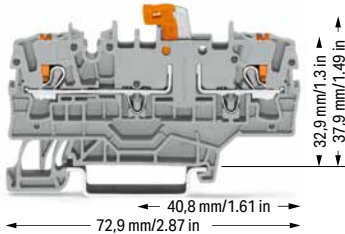

2-conductor disconnect/test terminal block; with push-button; with test point; orange disconnect link; with additional jumper slot

Color	Item No.	VPE
gray	2202-1971	50
blue	2202-1974	50
orange	2202-1972	50

Technical Data	
0.25 ... 2.5 (4) mm ² ①	22 ... 12 AWG
400 V/6 kV/3 ②	300 V, 10 A ③
I _N 10 A ④	300 V, 10 A ④
Terminal block width: 5.2 mm / 0.205 inch	
10 ... 12 mm / 0.39 ... 0.47 inch	

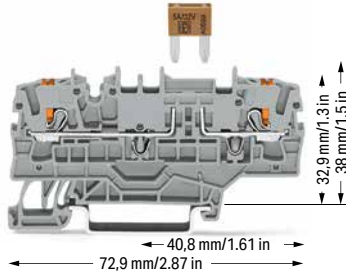

2-conductor fuse terminal block; with push-button; for mini-automotive blade-style fuse; with test point; without blown fuse indication; with additional jumper slot
Electrical ratings are given by the fuse. Blade-style fuses: Observe touch-proof protection for 42 V and higher voltages!

Color	Item No.	VPE
gray	2202-1981	50

Technical Data	
0.25 ... 2.5 (4) mm ² ①	22 ... 12 AWG
400 V/6 kV/3 ②	300 V, 15 A ③
I _N 16 A	300 V, 15 A ④
Terminal block width: 5.2 mm / 0.205 inch	
10 ... 12 mm / 0.39 ... 0.47 inch	

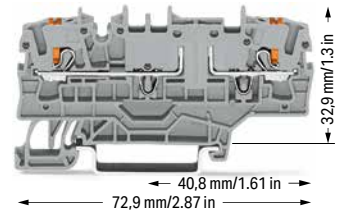

2-conductor carrier terminal block; with push-button; with test point; with additional jumper slot

Color	Item No.	VPE
gray	2202-1961	50

Accessories; item-specific

Disconnect plug for carrier terminal blocks; suitable when using a carrier terminal block as disconnect terminal block

	orange	2002-401	100 (25)
--	--------	----------	----------

Accessories; 2202 Series

Appropriate marking systems: WMB/WMB Inline/Marking strips

End and intermediate plate; 1 mm thick

	orange	2002-1992	100 (25)
	gray	2002-1991	100 (25)

Insulation stop; 5 pcs/strip; 0.25 ... 0.5 mm²

	light gray	2002-171	200 (25)
--	------------	----------	----------

Insulation stop; 5 pcs/strip; 0.75 ... 1 mm²

	dark gray	2002-172	200 (25)
--	-----------	----------	----------

Push-in type jumper bar; insulated; I_N 25 A; light gray

	2-way	2002-402	25
	3-way	2002-403	25
	4-way	2002-404	25
	5-way	2002-405	25
	6-way	2002-406	25
	7-way	2002-407	25
	8-way	2002-408	25
	9-way	2002-409	25
	10-way	2002-410	25

Push-in type jumper bar; insulated; I_N 25 A; light gray

	1 to 3	2002-433	25
	1 to 4	2002-434	25
	1 to 5	2002-435	25
	1 to 6	2002-436	25
	1 to 7	2002-437	25
	1 to 8	2002-438	25
	1 to 9	2002-439	25
	1 to 10	2002-440	25

Delta jumper; insulated; I_N = I_N terminal block; light gray

	1-2 3-4 5-6	2002-406/020-000	25
--	-------------	------------------	----

Star point jumper; insulated; I_N = I_N terminal block; light gray

	1-3-5	2002-405/011-000	25
--	-------	------------------	----

Adjacent jumper for continuous commoning; insulated; I_N 25 A; light gray

	2-way	2002-400	25
--	-------	----------	----

Staggered jumper; insulated; I_N 25 A; light gray

	2-way	2002-472	25
	3-way	2002-473	25
	4-way	2002-474	25
	5-way	2002-475	25
	6-way	2002-476	25
	7-way	2002-477	25
	8-way	2002-478	25
	9-way	2002-479	25
	10-way	2002-480	25
	11-way	2002-481	25
	12-way	2002-482	25

Customized staggered jumper; insulated; with contact lugs broken off at the factory and circuit printing; I_N 25 A; light gray

	1-3	2002-473/011-000	25
	1-3-5	2002-475/011-000	25
	1-3-5-7	2002-477/011-000	25
	1-3-5-7-9	2002-479/011-000	25
	1-3-5-7-9-11	2002-481/011-000	25



Technical Data

0.25 ... 2.5 (4) mm² ① | 22 ... 12 AWG400 V/6 kV/3 ② | 300 V, 15 A I_N 16 A | 300 V, 15 A 

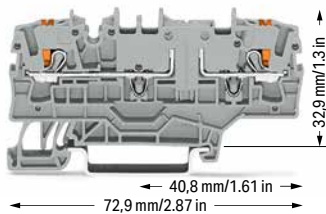
Terminal block width: 5.2 mm / 0.205 inch

 10 ... 12 mm / 0.39 ... 0.47 inch

2-conductor through terminal block; with push-button; with test point; with additional jumper slot; same profile as 2-conductor disconnect terminal block

Color	Item No.	VPE
 gray	2202-1901	50
 blue	2202-1904	50
 orange	2202-1902	50

2-conductor ground terminal block; with push-button; with test point; with additional jumper slot

 green-yellow	2202-1907	50
--	-----------	----

Other terminal blocks with the same profile:

Fuse	2202-1911	Page 102
------	-----------	----------

① Conductor range: 0.25 ... 4 mm² "s+f-st";
Push-in termination: 1 ... 4 mm² "s" and 1 ... 2.5 mm² "insulated ferrules, 12 mm"
Depending on the conductor characteristic, a conductor with a smaller cross section can also be inserted via push-in termination.

② 400 V = rated voltage
6 kV = rated impulse voltage
3 = pollution degree
(see Section 15)

③ Observe touch-proof protection for 42 V and higher voltages!
• 10 A (individual arrangement)
• 5 A (block arrangement)

Blade-style fuses are not offered by WAGO.

Please observe the application notes:
Jumpers, from page 174
Testing accessories, from page 169
Marking, from page 640

Approvals and corresponding ratings, visit www.wago.com

Accessories; 2202 Series

Appropriate marking systems:
WMB/WMB Inline/Marking strips

Marking strip; plain; 11 mm wide; 50 m reel

	white	2009-110	1
---	-------	----------	---

WMB Inline; plain; 1,500 WMB markers (5 mm)/reel; stretchable 5 ... 5.2 mm

	white	2009-115	1
---	-------	----------	---

WMB marker card; white; 10 strips with 10 markers/card; stretchable 5 ... 5.2 mm

	plain	793-5501	5
---	-------	----------	---

Adjacent jumper for continuous commoning; insulated; I_N 25 A; 1 to 3

	light gray	2002-423	25
	red	2002-423/000-005	25
	blue	2002-423/000-006	25

Push-in type wire jumper; insulated; 1.5 mm² conductor cross-section; I_N 18 A

	L = 60 mm	2009-412	100 (10)
	L = 110 mm	2009-414	100 (10)
	L = 250 mm	2009-416	100 (10)

Modular connector; snaps together; for jumper contact slot

	gray	2002-511	100 (25)
---	------	----------	----------

Spacer module; snaps together; bridges commoned terminal blocks

	gray	2002-549	100 (25)
---	------	----------	----------

Fuse Terminal Block TOPJOB® S; with Push-Button; for Mini-Automotive Blade-Style Fuse; with Additional Jumper Slot 2.5 (4) mm²; 2202 Series

1

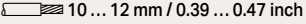
Technical Data	
0.25 ... 2.5 (4) mm ² ①	22 ... 12 AWG
400 V/6 kV/3 ②	12 V, 10 A ^{III}
I _N 10 A ③	12 V, 10 A [Ⓞ]
Terminal block width: 5.2 mm / 0.205 inch	
 10 ... 12 mm / 0.39 ... 0.47 inch	

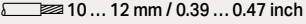
Technical Data	
0.25 ... 2.5 (4) mm ² ①	22 ... 12 AWG
400 V/6 kV/3 ②	24 V, 10 A ^{III}
I _N 10 A ③	24 V, 10 A [Ⓞ]
Terminal block width: 5.2 mm / 0.205 inch	
 10 ... 12 mm / 0.39 ... 0.47 inch	

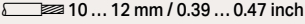
Technical Data	
0.25 ... 2.5 (4) mm ² ①	22 ... 12 AWG
400 V/6 kV/3 ②	48 V, 10 A ^{III}
I _N 10 A ③	48 V, 10 A [Ⓞ]
Terminal block width: 5.2 mm / 0.205 inch	
 10 ... 12 mm / 0.39 ... 0.47 inch	

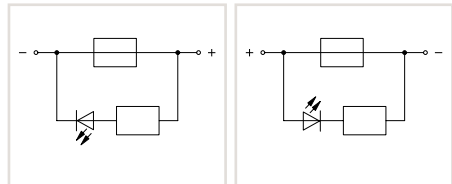
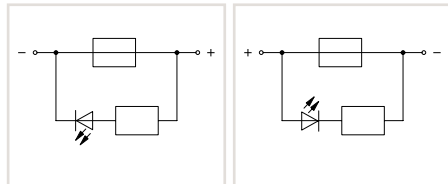
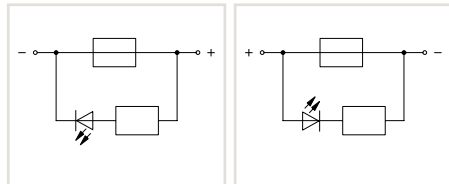
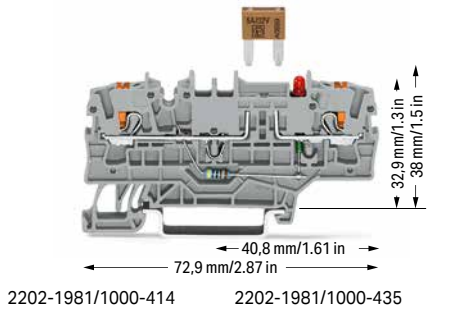
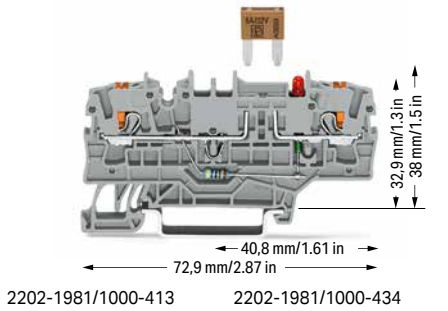
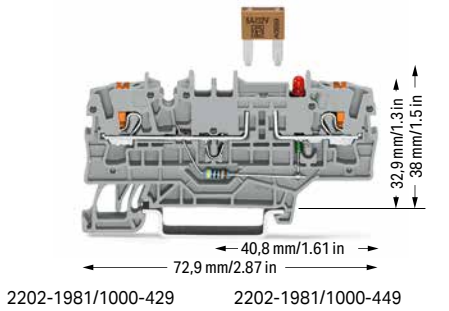

2-conductor fuse terminal block; with push-button; for mini-automotive blade-style fuse; with test point; 12 V; with blown fuse indication by LED; LED power consumption: 4.8 mA; with additional jumper slot; gray Electrical ratings are given by the fuse and blown fuse indication. Blade-style fuses: Observe touch-proof protection for 42 V and higher voltages!

2-conductor fuse terminal block; with push-button; for mini-automotive blade-style fuse; with test point; 24 V; with blown fuse indication by LED; LED power consumption: 4.8 mA; with additional jumper slot; gray Electrical ratings are given by the fuse and blown fuse indication. Blade-style fuses: Observe touch-proof protection for 42 V and higher voltages!

2-conductor fuse terminal block; with push-button; for mini-automotive blade-style fuse; with test point; 48 V; with blown fuse indication by LED; LED power consumption: 4.8 mA; with additional jumper slot; gray Electrical ratings are given by the fuse and blown fuse indication. Blade-style fuses: Observe touch-proof protection for 42 V and higher voltages!

	Item No.	Pack. Unit
○ anode right	2202-1981/1000-429	50
○ anode left	2202-1981/1000-449	50



	Item No.	Pack. Unit
○ anode right	2202-1981/1000-413	50
○ anode left	2202-1981/1000-434	50

	Item No.	Pack. Unit
○ anode right	2202-1981/1000-414	50
○ anode left	2202-1981/1000-435	50

Other terminal blocks with the same profile
Through **2202-1901** Page 99



Accessories; 2202 Series









Appropriate marking systems: WMB/WMB Inline/Marking strips









End and intermediate plate; 1 mm thick			
	orange	2002-1992	100 (25)
	gray	2002-1991	100 (25)











Insulation stop; 5 pcs/strip; 0.25 ... 0.5 mm ²			
	light gray	2002-171	200 (25)

Insulation stop; 5 pcs/strip; 0.75 ... 1 mm ²			
	dark gray	2002-172	200 (25)



Push-in type wire jumper; insulated; 1.5 mm ² conductor cross-section; I _N 18 A			
	L = 60 mm	2009-412	100 (10)
	L = 110 mm	2009-414	100 (10)
	L = 250 mm	2009-416	100 (10)

Push-in type jumper bar; insulated; I _N 25 A; light gray			
	2-way	2002-402	25
	3-way	2002-403	25
	4-way	2002-404	25
	5-way	2002-405	25
	6-way	2002-406	25
	7-way	2002-407	25
	8-way	2002-408	25
	9-way	2002-409	25
	10-way	2002-410	25

Push-in type jumper bar; insulated; I _N 25 A; light gray			
	1 to 3	2002-433	25
	1 to 4	2002-434	25
	1 to 5	2002-435	25
	1 to 6	2002-436	25
	1 to 7	2002-437	25
	1 to 8	2002-438	25
	1 to 9	2002-439	25
	1 to 10	2002-440	25

Staggered jumper; insulated; I _N 25 A; light gray			
	2-way	2002-472	25
	3-way	2002-473	25
	4-way	2002-474	25
	5-way	2002-475	25
	6-way	2002-476	25
	7-way	2002-477	25
	8-way	2002-478	25
	9-way	2002-479	25
	10-way	2002-480	25
	11-way	2002-481	25
	12-way	2002-482	25

Adjacent jumper for continuous commoning; insulated; I _N 25 A; light gray			
	2-way	2002-400	25

Adjacent jumper for continuous commoning; insulated; I _N 25 A; 1 to 3			
	light gray	2002-423	25
	red	2002-423/000-005	25
	blue	2002-423/000-006	25

Technical Data

0.25 ... 2.5 (4) mm ² ①	22 ... 12 AWG
400 V/6 kV/3 ②	300 V, 10 A ③
I _N 10 A ③	300 V, 10 A ③
Terminal block width: 5.2 mm / 0.205 inch	
10 ... 12 mm / 0.39 ... 0.47 inch	

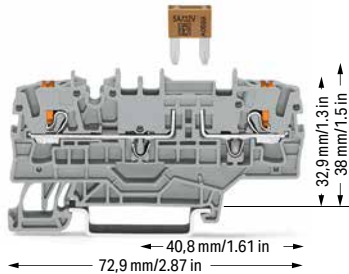

① Conductor range: 0.25 ... 2.5 mm² "s+f-st" and 0.25 ... 4 mm² "s";
Push-in termination: 1 ... 4 mm² "s" and 1 ... 2.5 mm² "insulated ferrules, 12 mm"
Depending on the conductor characteristic, a conductor with a smaller cross section can also be inserted via push-in termination.

② 400 V = rated voltage
6 kV = rated impulse voltage
3 = pollution degree
(see Section 15)

③ Observe touch-proof protection for 42 V and higher voltages!
• 10 A (individual arrangement)
• 5 A (block arrangement)

Blade-style fuses are not offered by WAGO.

Please observe the application notes:
Jumpers, from page 174
Testing accessories, from page 169
Marking, from page 640

Approvals and corresponding ratings,
visit www.wago.com

2-conductor fuse terminal block; with push-button; for mini-automotive blade-style fuse; with test point; without blown fuse indication; with additional jumper slot
Electrical ratings are given by the fuse. Blade-style fuses: Observe touch-proof protection for 42 V and higher voltages!

Color	Item No.	Pack. Unit
○ gray	2202-1981	50

Marking strip; plain; 11 mm wide; 50 m reel

	white	2009-110	1
---	-------	----------	---

WMB Inline; plain; 1,500 WMB markers (5 mm)/reel; stretchable 5 ... 5.2 mm

	white	2009-115	1
---	-------	----------	---

WMB marker card; white; 10 strips with 10 markers/card; stretchable 5 ... 5.2 mm

	plain	793-5501	5
---	-------	----------	---

Double-deck marker carrier; pivoting

	gray	2002-121	50 (25)
---	------	----------	---------

Fused Disconnect Terminal Block with a Pivoting Fuse Holder TOPJOB® S; with Push-Button; for (5 x 20) mm Glass Cartridge Fuse 2.5 (4) mm²; 2202 Series

1

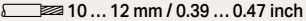
Technical Data	
0.25 ... 2.5 (4) mm ² ①	22 ... 12 AWG
250 V/6 kV/3 ②	250 V, 10 A ③
I _N 6.3 A	250 V, 10 A ④
Terminal block width: 6.2 mm / 0.244 inch	
 10 ... 12 mm / 0.39 ... 0.47 inch	

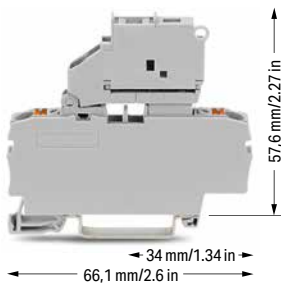

2-conductor fused disconnect terminal block with a pivoting fuse holder; with push-button; for (5 x 20) mm glass cartridge fuse; without blown fuse indication. Electrical ratings are given by the fuse.

	Item No.	Pack. Unit
○ gray	2202-1611	50

2-conductor fused disconnect terminal block with a pivoting fuse holder; with push-button; for (5 x 20) mm glass cartridge fuse; with blown fuse indication by LED; gray. Electrical ratings are given by the fuse and blown fuse indication. Leakage current in case of a blown fuse: LED 2 mA

○ 12 ... 30 V	2202-1611/1000-541	50
○ 30 ... 65 V	2202-1611/1000-542	50
○ 120 V	2202-1611/1000-867	50
○ 230 V	2202-1611/1000-836	50

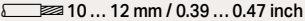
Technical Data	
0.25 ... 2.5 (4) mm ² ①	22 ... 12 AWG
250 V/6 kV/3 ②	250 V, 10 A ③
I _N 6.3 A	250 V, 10 A ④
Terminal block width: 6.2 mm / 0.244 inch	
 10 ... 12 mm / 0.39 ... 0.47 inch	

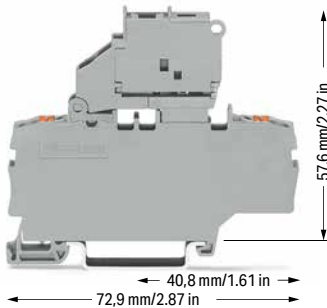

2-conductor fused disconnect terminal block with a pivoting fuse holder; with push-button; with additional jumper slot; for (5 x 20) mm glass cartridge fuse; without blown fuse indication. Electrical ratings are given by the fuse.

	Item No.	Pack. Unit
○ gray	2202-1911	50

2-conductor fused disconnect terminal block with a pivoting fuse holder; with push-button; with additional jumper slot; for (5 x 20) mm glass cartridge fuse; with blown fuse indication; gray. Electrical ratings are given by the fuse and blown fuse indication. Leakage current in case of a blown fuse: LED 2 mA

○ 12 ... 30 V	2202-1911/1000-541	50
○ 30 ... 65 V	2202-1911/1000-542	50
○ 120 V	2202-1911/1000-867	50
○ 230 V	2202-1911/1000-836	50

Accessories; item-specific

Push-in type wire jumper; insulated; 1.5 mm² conductor cross section; I_N 18 A

	L = 60 mm	2009-412	100 (10)
	L = 110 mm	2009-414	100 (10)
	L = 250 mm	2009-416	100 (10)

Other terminal blocks with the same profile:		
Through	2202-1601	Page 93

Other terminal blocks with the same profile:		
Through	2202-1901	Page 99

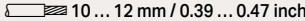
Technical Data	
0.25 ... 2.5 (4) mm ² ①	22 ... 12 AWG
250 V/6 kV/3 ②	250 V, 10 A ③
I _N 6.3 A	250 V, 10 A ④
Terminal block width: 6.2 mm / 0.244 inch	
 10 ... 12 mm / 0.39 ... 0.47 inch	

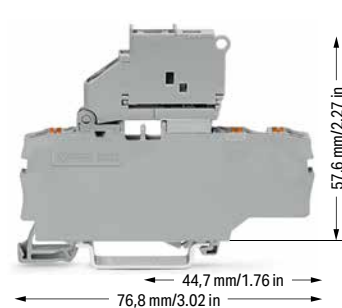

3-conductor fused disconnect terminal block with a pivoting fuse holder; with push-button; for (5 x 20) mm glass cartridge fuse; without blown fuse indication. Electrical ratings are given by the fuse.

	Item No.	Pack. Unit
○ gray	2202-1711	50

3-conductor fused disconnect terminal block with a pivoting fuse holder; with push-button; for (5 x 20) mm glass cartridge fuse; with blown fuse indication by LED; gray. Electrical ratings are given by the fuse and blown fuse indication. Leakage current in case of a blown fuse: LED 2 mA

○ 12 ... 30 V	2202-1711/1000-541	50
○ 30 ... 65 V	2202-1711/1000-542	50
○ 120 V	2202-1711/1000-867	50
○ 230 V	2202-1711/1000-836	50

Accessories; 2202 Series

Appropriate marking systems: WMB/WMB Inline/Marking strips

End plate for fuse terminal blocks; 2 mm thick			
	orange	2002-992	100 (25)
	gray	2002-991	100 (25)

Insulation stop; 5 pcs/strip; 0.25 ... 0.5 mm ²			
	light gray	2002-171	200 (25)

Insulation stop; 5 pcs/strip; 0.75 ... 1 mm ²			
	dark gray	2002-172	200 (25)

Interlocking link; mechanically locks multiple links; 1 m long			
	transparent	210-254	1

Push-in type jumper bar; insulated; I _N 32 A; light gray			
	2-way	2004-402	25
	3-way	2004-403	25
	4-way	2004-404	25
	5-way	2004-405	25
	6-way	2004-406	25
	7-way	2004-407	25
	8-way	2004-408	25
	9-way	2004-409	25
	10-way	2004-410	25

Push-in type jumper bar; insulated; I _N 32 A; light gray			
	1 to 3	2004-433	25
	1 to 4	2004-434	25
	1 to 5	2004-435	25
	1 to 6	2004-436	25
	1 to 7	2004-437	25
	1 to 8	2004-438	25
	1 to 9	2004-439	25
	1 to 10	2004-440	25

Marking strip; plain; 11 mm wide; 50 m reel			
	white	2009-110	1

WMB marker card; white; 10 strips with 10 markers/card; stretchable 5 ... 5.2 mm			
	plain	793-5501	5

Technical Data

0.25 ... 2.5 (4) mm ² ①	22 ... 12 AWG
250 V/6 kV/3 ②	250 V, 10 A ③
I _N 6.3 A	250 V, 10 A ④
Terminal block width: 6.2 mm / 0.244 inch	
10 ... 12 mm / 0.39 ... 0.47 inch	



4-conductor fused disconnect terminal block with a pivoting fuse holder; with push-button; for (5 x 20) mm glass cartridge fuse; without blown fuse indication
Electrical ratings are given by the fuse.

	Item No.	Pack. Unit
○ gray	2202-1811	50

4-conductor fused disconnect terminal block with a pivoting fuse holder; with push-button; for (5 x 20) mm glass cartridge fuse; with blown fuse indication by LED; gray
Electrical ratings are given by the fuse and blown fuse indication. Leakage current in case of a blown fuse: LED 2 mA

○ 12 ... 30 V	2202-1811/1000-541	50
○ 30 ... 65 V	2202-1811/1000-542	50
○ 120 V	2202-1811/1000-867	50
○ 230 V	2202-1811/1000-836	50

Other terminal blocks with the same profile:

Through	2202-1801	Page 97
---------	-----------	---------

① Conductor range: 0.25 ... 2.5 mm² "s+f-st" and 0.25 ... 4 mm² "s";
Push-in termination: 1 ... 4 mm² "s" and 1 ... 2.5 mm² "insulated ferrules, 12 mm"
Depending on the conductor characteristic, a conductor with a smaller cross section can also be inserted via push-in termination.

② 250 V = rated voltage
6 kV = rated impulse voltage
3 = pollution degree (see Section 15)

Please observe the application notes:
Jumpers, page 164
Marking, from page 640

A protective warning marker and an insulation stop must be applied individually. Due to the 6.2 mm width of double-deck terminal blocks with end plates, 2004 Series Push-In Type Jumper Bars must be used.

Approvals and corresponding ratings, visit www.wago.com

Miniature fuses 5 x 20

Series Item No.	Overload and short circuit protection		Short circuit protection only	
	Individual argmt.	Group argmt.	Individual argmt.	Group argmt.
Fuse terminal blocks				
2202-1611				
2202-1711	1.6 W	1.6 W	2.5 W	2.5 W
2202-1811				
2202-1611/.....				
2202-1711/.....	1.6 W	1.6 W	2.5 W	2.5 W
2202-1811/.....				

When selecting glass cartridge fuses, make sure that the maximum power loss listed below is not exceeded. The power loss is determined according to IEC or EN 60947-7-3/VDE 0611-6 at 23°C. The temperature rise of the terminal block must be checked according to their application and mounting. Higher ambient temperatures represent an additional impact on miniature fuses. Therefore, in such applications, the rated current must be reduced if necessary. More details are available from the manufacturers.

Miniature fuses 5 x 20

Series Item No.	Overload and short circuit protection		Short circuit protection only	
	Individual argmt.	Group argmt.	Individual argmt.	Group argmt.
Fuse terminal blocks				
2202-1911	1.6 W	1.6 W	2.5 W	2.5 W
2202-1911/.....	1.6 W	1.6 W	2.5 W	2.5 W

When selecting glass cartridge fuses, make sure that the maximum power loss listed below is not exceeded. The power loss is determined according to IEC or EN 60947-7-3/VDE 0611-6 at 23°C. The temperature rise of the terminal block must be checked according to their application and mounting. Higher ambient temperatures represent an additional impact on miniature fuses. Therefore, in such applications, the rated current must be reduced if necessary. More details are available from the manufacturers.

Disconnect/Test Terminal Block, Fuse Terminal Block, Carrier Terminal Block, Through Terminal Block TOPJOB® S

2.5 (4) mm²; 2002 Series

1

Technical Data	
0.25 ... 2.5 (4) mm ² ①	22 ... 12 AWG
400 V/6 kV/3 ②	300 V, 15 A ③
I _N 16 A	300 V, 15 A ④
Terminal block width: 5.2 mm / 0.205 inch	
10 ... 12 mm / 0.39 ... 0.47 inch	



2-conductor disconnect/test terminal block; with test point; orange disconnect link

Color	Item No.	VPE
gray ⑤	2002-1671 ⑥	50
blue ⑤	2002-1674 ④ ⑤	50
orange ⑤	2002-1672 ⑥	50

Technical Data	
0.25 ... 2.5 (4) mm ² ①	22 ... 12 AWG
400 V/6 kV/3 ②	300 V, 15 A ③
I _N 16 A	300 V, 15 A ④
Terminal block width: 5.2 mm / 0.205 inch	
10 ... 12 mm / 0.39 ... 0.47 inch	

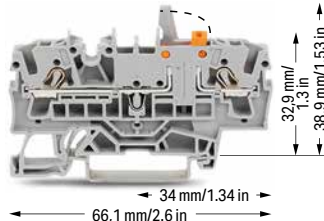

2-conductor disconnect/test terminal block; with mechanical interlock; with test point; orange disconnect link

Color	Item No.	VPE
gray ⑤	2002-1671/401-000 ⑤	50
blue ⑤	2002-1674/401-000 ④ ⑤	50
orange ⑤	2002-1672/401-000 ⑥	50

Technical Data	
0.25 ... 2.5 (4) mm ² ①	22 ... 12 AWG
400 V/6 kV/3 ②	250 V, 10 A ③
I _N 10 A ④	250 V, 10 A ④
Terminal block width: 5.2 mm / 0.205 inch	
10 ... 12 mm / 0.39 ... 0.47 inch	

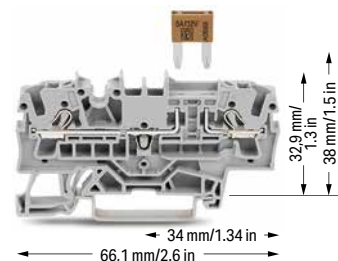

2-conductor fuse terminal block; for mini-automotive blade-style fuse; with test point
Electrical ratings are given by the fuse. Blade-style fuses: Observe touch-proof protection for 42 V and higher voltages!

Color	Item No.	VPE
gray ⑤	2002-1681 ⑥	50

Accessories; 2002 Series

Appropriate marking systems: WMB/WMB Inline/Marking strips

End and intermediate plate; 1 mm thick			
	orange	2002-1692	100 (25)
	gray	2002-1691	100 (25)

Ex e/Ex i separator; orange; 3 mm thick			
	120 mm	209-191	50 (25)

Insulation stop; 5 pcs/strip; 0.25 ... 0.5 mm ²			
	light gray	2002-171	200 (25)

Insulation stop; 5 pcs/strip; 0.75 ... 1 mm ²			
	dark gray	2002-172	200 (25)

Push-in type jumper bar; insulated; I _N 25 A; light gray			
	2-way	2002-402	25
	3-way	2002-403	25
	4-way	2002-404	25
	5-way	2002-405	25
	6-way	2002-406	25
	7-way	2002-407	25
	8-way	2002-408	25
	9-way	2002-409	25
	10-way	2002-410	25

Push-in type jumper bar; insulated; I _N 25 A; light gray			
	1 to 3	2002-433	25
	1 to 4	2002-434	25
	1 to 5	2002-435	25
	1 to 6	2002-436	25
	1 to 7	2002-437	25
	1 to 8	2002-438	25
	1 to 9	2002-439	25
	1 to 10	2002-440	25

Delta jumper; insulated; I _N = I _N terminal block; light gray			
	1-2 3-4 5-6	2002-406/020-000	25

Star point jumper; insulated; I _N = I _N terminal block; light gray			
	1-3-5	2002-405/011-000	25

Adjacent jumper for continuous commoning; insulated; I _N 25 A; light gray			
	2-way	2002-400	25

Adjacent jumper for continuous commoning; insulated; I _N 25 A; 1 to 3			
	light gray	2002-423	25
	red	2002-423/000-005	25
	blue	2002-423/000-006	25

Staggered jumper; insulated; I _N 25 A; light gray			
	2-way	2002-472	25
	3-way	2002-473	25
	4-way	2002-474	25
	5-way	2002-475	25
	6-way	2002-476	25
	7-way	2002-477	25
	8-way	2002-478	25
	9-way	2002-479	25
	10-way	2002-480	25
	11-way	2002-481	25
	12-way	2002-482	25

Customized staggered jumper; insulated; with contact lugs broken off at the factory and circuit printing; I _N 25 A; light gray			
	1-3	2002-473/011-000	25
	1-3-5	2002-475/011-000	25
	1-3-5-7	2002-477/011-000	25
	1-3-5-7-9	2002-479/011-000	25
	1-3-5-7-9-11	2002-481/011-000	25

Push-in type wire jumper; insulated; 1.5 mm ² conductor cross-section; I _N 18 A			
	L = 60 mm	2009-412	100 (10)
	L = 110 mm	2009-414	100 (10)
	L = 250 mm	2009-416	100 (10)

Technical Data

0.25 ... 2.5 (4) mm ² ①	22 ... 12 AWG
400 V/6 kV/3 ②	300 V, 15 A ③
I _N 16 A	300 V, 15 A ④
Terminal block width: 5.2 mm / 0.205 inch	
 10 ... 12 mm / 0.39 ... 0.47 inch	

Technical Data

0.25 ... 2.5 (4) mm ² ①	22 ... 12 AWG
400 V/6 kV/3 ②	300 V, 15 A ③
I _N 16 A	300 V, 15 A ④
Terminal block width: 5.2 mm / 0.205 inch	
 10 ... 12 mm / 0.39 ... 0.47 inch	

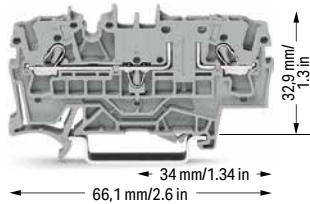

2-conductor carrier terminal block; with test point

Color	Item No.	VPE
○ gray ⑤	2002-1661 ⑤	50

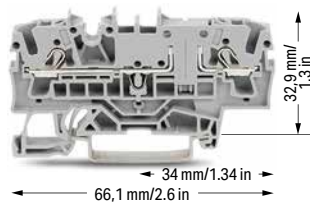

2-conductor through terminal block; with test point; same profile as 2-conductor disconnect terminal block

Color	Item No.	VPE
○ gray ⑤	2002-1601 ⑤	50
● blue ⑤	2002-1604 ④ ⑤	50
● orange ⑤	2002-1602 ⑤	50

Other terminal blocks with the same profile:

Fuse	2002-1611	Page 112
------	-----------	----------

Accessories; item-specific

Disconnect plug for carrier terminal blocks; suitable when using a carrier terminal block as disconnect terminal block

	orange	2002-401	100 (25)
---	--------	----------	----------

Protective warning marker; with black high-voltage symbol; for 5 terminal blocks

	yellow	2002-115	100 (25)
---	--------	----------	----------

Modular connector; snaps together; for jumper contact slot

	gray	2002-511	100 (25)
---	------	----------	----------

Spacer module; snaps together; bridges commoned terminal blocks

	gray	2002-549	100 (25)
---	------	----------	----------

Marking strip; plain; 11 mm wide; 50 m reel

	white	2009-110	1
---	-------	----------	---

WMB Inline; plain; 1,500 WMB markers (5 mm)/reel; stretchable 5 ... 5.2 mm

	white	2009-115	1
---	-------	----------	---

WMB marker card; white; 10 strips with 10 markers/card; stretchable 5 ... 5.2 mm

	plain	793-5501	5
---	-------	----------	---

① Conductor range: 0.25 ... 4 mm² "s+f-st"; Push-in termination: 1 ... 4 mm² "s" and 1 ... 2.5 mm² "insulated ferrules, 12 mm" Depending on the conductor characteristic, a conductor with a smaller cross section can also be inserted via push-in termination.

② 400 V = rated voltage
6 kV = rated impulse voltage
3 = pollution degree (see Section 15)

③ Observe touch-proof protection for 42 V and higher voltages!
• 10 A (individual arrangement)
• 5 A (block arrangement)

④ Terminal blocks with a blue insulated housing are suitable for Ex i applications.

⑤ Terminal blocks with an Ex mark are suitable for Ex e II applications.
440 V; 17 A (see Section 15)

Blade-style fuses are not offered by WAGO.

Please observe the application notes:
Jumpers, from page 174
Testing accessories, from page 169
Marking, from page 640

Approvals and corresponding ratings, visit www.wago.com

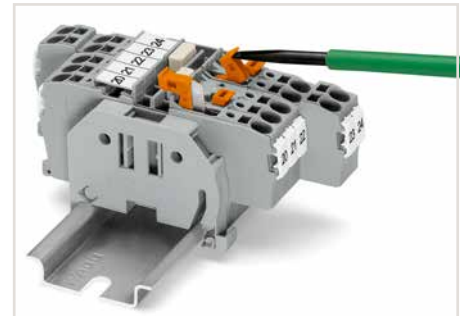

Disconnect/test terminal block with pivoting knife disconnect – opening a knife disconnect.



Disconnect/test terminal block with pivoting knife disconnect – closing the knife disconnect.



Disconnect/test terminal block with pivoting knife disconnect – testing with voltage tester.

Disconnect/Test Terminal Block, Fuse Terminal Block, Carrier Terminal Block, Through Terminal Block, Ground Conductor Terminal Block TOPJOB® S

2.5 (4) mm²; 2002 Series

1

Technical Data	
0.25 ... 2.5 (4) mm ² ①	22 ... 12 AWG
400 V/6 kV/3 ②	300 V, 15 A ③
I _N 16 A	300 V, 15 A ④
Terminal block width: 5.2 mm / 0.205 inch	
10 ... 12 mm / 0.39 ... 0.47 inch	

Technical Data	
0.25 ... 2.5 (4) mm ² ①	22 ... 12 AWG
400 V/6 kV/3 ②	300 V, 15 A ③
I _N 16 A	300 V, 15 A ④
Terminal block width: 5.2 mm / 0.205 inch	
10 ... 12 mm / 0.39 ... 0.47 inch	

Technical Data	
0.25 ... 2.5 (4) mm ² ①	22 ... 12 AWG
400 V/6 kV/3 ②	250 V, 10 A ③
I _N 10 A ④	250 V, 10 A ④
Terminal block width: 5.2 mm / 0.205 inch	
10 ... 12 mm / 0.39 ... 0.47 inch	

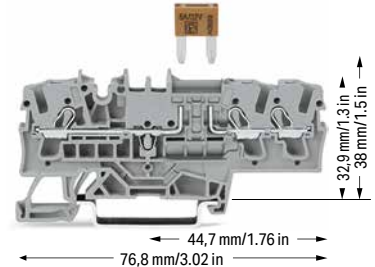
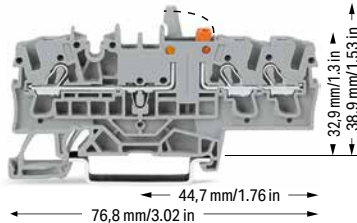
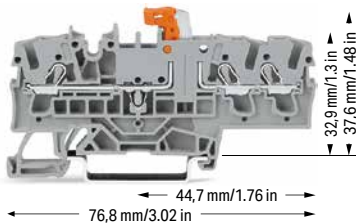

3-conductor disconnect/test terminal block; with test point; orange disconnect link

3-conductor disconnect/test terminal block; with mechanical interlock; with test point; orange disconnect link

3-conductor fuse terminal block; for mini-automotive blade-style fuse; with test point
Electrical ratings are given by the fuse. Blade-style fuses: Observe touch-proof protection for 42 V and higher voltages!

Color	Item No.	VPE
gray ⑤	2002-1771 ⑥	50
blue ⑤	2002-1774 ④ ⑤	50
orange ⑤	2002-1772 ⑥	50

Color	Item No.	VPE
gray ⑤	2002-1771/401-000 ⑤	50
blue ⑤	2002-1774/401-000 ④ ⑤	50
orange ⑤	2002-1772/401-000 ⑥	50

Color	Item No.	VPE
gray ⑤	2002-1781 ⑥	50

Accessories; 2002 Series

Appropriate marking systems: WMB/WMB Inline/Marking strips

End and intermediate plate; 1 mm thick			
orange	2002-1792	100 (25)	
gray	2002-1791	100 (25)	

Ex e/Ex i separator; orange; 3 mm thick			
120 mm	209-191	50 (25)	

Insulation stop; 5 pcs/strip; 0.25 ... 0.5 mm ²			
light gray	2002-171	200 (25)	

Insulation stop; 5 pcs/strip; 0.75 ... 1 mm ²			
dark gray	2002-172	200 (25)	

Delta jumper; insulated; I _N = I _N terminal block; light gray			
1-2 3-4 5-6	2002-406/020-000	25	

Star point jumper; insulated; I _N = I _N terminal block; light gray			
1-3-5	2002-405/011-000	25	

Push-in type jumper bar; insulated; I _N 25 A; light gray			
2-way	2002-402	25	
3-way	2002-403	25	
4-way	2002-404	25	
5-way	2002-405	25	
6-way	2002-406	25	
7-way	2002-407	25	
8-way	2002-408	25	
9-way	2002-409	25	
10-way	2002-410	25	

Push-in type jumper bar; insulated; I _N 25 A; light gray			
1 to 3	2002-433	25	
1 to 4	2002-434	25	
1 to 5	2002-435	25	
1 to 6	2002-436	25	
1 to 7	2002-437	25	
1 to 8	2002-438	25	
1 to 9	2002-439	25	
1 to 10	2002-440	25	

Adjacent jumper for continuous commoning; insulated; I _N 25 A; light gray			
2-way	2002-400	25	

Adjacent jumper for continuous commoning; insulated; I _N 25 A; 1 to 3			
light gray	2002-423	25	
red	2002-423/000-005	25	
blue	2002-423/000-006	25	

Staggered jumper; insulated; I _N 25 A; light gray			
2-way	2002-472	25	
3-way	2002-473	25	
4-way	2002-474	25	
5-way	2002-475	25	
6-way	2002-476	25	
7-way	2002-477	25	
8-way	2002-478	25	
9-way	2002-479	25	
10-way	2002-480	25	
11-way	2002-481	25	
12-way	2002-482	25	

Customized staggered jumper; insulated; with contact lugs broken off at the factory and circuit printing; I _N 25 A; light gray			
1-3	2002-473/011-000	25	
1-3-5	2002-475/011-000	25	
1-3-5-7	2002-477/011-000	25	
1-3-5-7-9	2002-479/011-000	25	
1-3-5-7-9-11	2002-481/011-000	25	

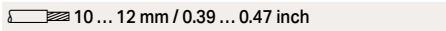
Technical Data	
0.25 ... 2.5 (4) mm ² ①	22 ... 12 AWG
400 V/6 kV/3 ②	300 V, 15 A ③
I _N 16 A	300 V, 15 A ④
Terminal block width: 5.2 mm / 0.205 inch	
 10 ... 12 mm / 0.39 ... 0.47 inch	

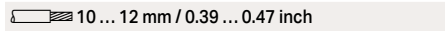
Technical Data	
0.25 ... 2.5 (4) mm ² ①	22 ... 12 AWG
400 V/6 kV/3 ②	300 V, 15 A ③
I _N 16 A	300 V, 15 A ④
Terminal block width: 5.2 mm / 0.205 inch	
 10 ... 12 mm / 0.39 ... 0.47 inch	

- Conductor range: 0.25 ... 4 mm² "s+f-st"; Push-in termination: 1 ... 4 mm² "s" and 1 ... 2.5 mm² "insulated ferrules, 12 mm" Depending on the conductor characteristic, a conductor with a smaller cross section can also be inserted via push-in termination.
- 400 V = rated voltage
6 kV = rated impulse voltage
3 = pollution degree (see Section 15)
- Observe touch-proof protection for 42 V and higher voltages!
• 10 A (individual arrangement)
• 5 A (block arrangement)
- Terminal blocks with a blue insulated housing are suitable for Ex i applications.
- Terminal blocks with an Ex mark are suitable for Ex e II applications.
440 V; 17 A (see Section 15)

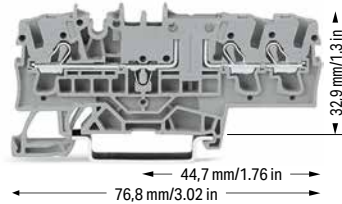
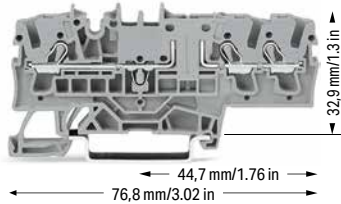

3-conductor carrier terminal block; with test point

3-conductor through terminal block; with test point; same profile as 3-conductor disconnect terminal block

Color	Item No.	VPE
gray ⑤	2002-1761 ⑤	50

Color	Item No.	VPE
gray ⑤	2002-1701 ⑤	50
blue ⑤	2002-1704 ④ ⑤	50
orange ⑤	2002-1702 ⑤	50

3-conductor ground terminal block; mit Prüfmöglichkeit		
green-yellow ⑤	2002-1707 ⑤	50

Other terminal blocks with the same profile:		
Fuse	2002-1711	Page 112

Accessories; item-specific
Disconnect plug for carrier terminal blocks; suitable when using a carrier terminal block as disconnect terminal block

	orange	2002-401	100 (25)
---	--------	----------	----------

Push-in type wire jumper; insulated; 1.5 mm² conductor cross-section; I_N 18 A

	L = 60 mm	2009-412	100 (10)
	L = 110 mm	2009-414	100 (10)
	L = 250 mm	2009-416	100 (10)

Protective warning marker; with black high-voltage symbol; for 5 terminal blocks

	yellow	2002-115	100 (25)
---	--------	----------	----------

Modular connector; snaps together; for jumper contact slot

	gray	2002-511	100 (25)
---	------	----------	----------

Spacer module; snaps together; bridges commoned terminal blocks

	gray	2002-549	100 (25)
---	------	----------	----------

Marking strip; plain; 11 mm wide; 50 m reel

	white	2009-110	1
---	-------	----------	---

WMB Inline; plain; 1,500 WMB markers (5 mm)/reel; stretchable 5 ... 5.2 mm

	white	2009-115	1
---	-------	----------	---

WMB marker card; white; 10 strips with 10 markers/card; stretchable 5 ... 5.2 mm

	plain	793-5501	5
---	-------	----------	---



Disconnect/test terminal block with pivoting knife disconnect and mechanical interlock – knife disconnect in open position

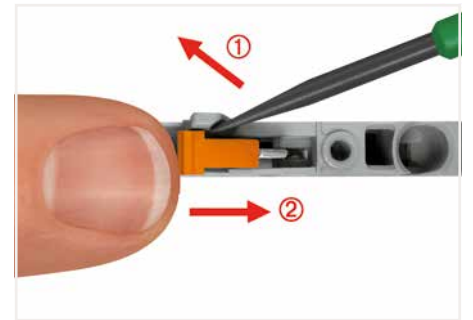

Disconnect/test terminal block with pivoting knife disconnect and mechanical interlock – closing the knife disconnect.

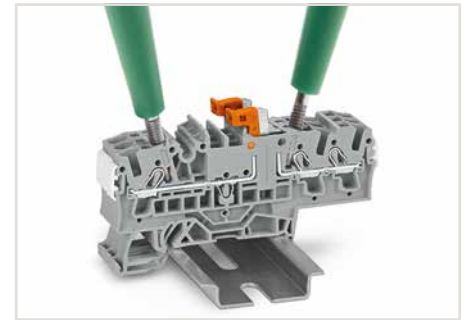

Disconnect/test terminal block with pivoting knife disconnect – testing with voltage tester.

Disconnect/Test Terminal Block, Fuse Terminal Block, Carrier Terminal Block, Through Terminal Block TOPJOB® S

2.5 (4) mm²; 2002 Series

1

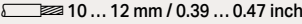
Technical Data	
0.25 ... 2.5 (4) mm ² ①	22 ... 12 AWG
400 V/6 kV/3 ②	300 V, 15 A ③
I _N 16 A	300 V, 15 A ④
Terminal block width: 5.2 mm / 0.205 inch	
 10 ... 12 mm / 0.39 ... 0.47 inch	

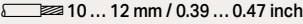
Technical Data	
0.25 ... 2.5 (4) mm ² ①	22 ... 12 AWG
400 V/6 kV/3 ②	300 V, 15 A ③
I _N 16 A	300 V, 15 A ④
Terminal block width: 5.2 mm / 0.205 inch	
 10 ... 12 mm / 0.39 ... 0.47 inch	

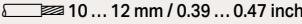
Technical Data	
0.25 ... 2.5 (4) mm ² ①	22 ... 12 AWG
400 V/6 kV/3 ②	250 V, 10 A ③
I _N 10 A ④	250 V, 10 A ④
Terminal block width: 5.2 mm / 0.205 inch	
 10 ... 12 mm / 0.39 ... 0.47 inch	

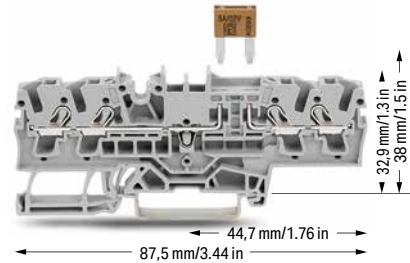
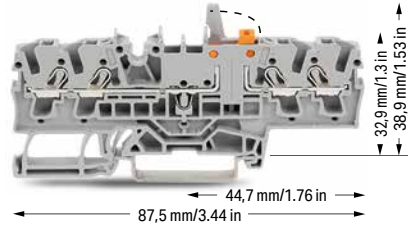
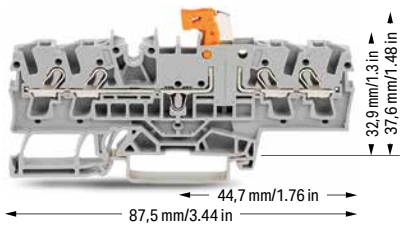

4-conductor disconnect/test terminal block; with test point; orange disconnect link

4-conductor disconnect/test terminal block; with mechanical interlock; with test point; orange disconnect link

4-conductor fuse terminal block; for mini-automotive blade-style fuse; with test point
Electrical ratings are given by the fuse. Blade-style fuses: Observe touch-proof protection for 42 V and higher voltages!

Color	Item No.	VPE
gray ⑤	2002-1871 ⑤	50
blue ⑤	2002-1874 ④ ⑤	50
orange ⑤	2002-1872 ⑤	50

Color	Item No.	VPE
gray ⑤	2002-1871/401-000 ⑤	50
blue ⑤	2002-1874/401-000 ④ ⑤	50
orange ⑤	2002-1872/401-000 ⑤	50

Color	Item No.	VPE
gray ⑤	2002-1881 ⑤	50

Accessories; 2002 Series









Appropriate marking systems: WMB/WMB Inline/Marking strips









End and intermediate plate; 1 mm thick			
	orange	2002-1892	100 (25)
	gray	2002-1891	100 (25)

Ex e/Ex i separator; orange; 3 mm thick			
	120 mm	209-191	50 (25)

Insulation stop; 5 pcs/strip; 0.25 ... 0.5 mm ²			
	light gray	2002-171	200 (25)

Insulation stop; 5 pcs/strip; 0.75 ... 1 mm ²			
	dark gray	2002-172	200 (25)

Push-in type jumper bar; insulated; I _N 25 A; light gray			
	2-way	2002-402	25
	3-way	2002-403	25
	4-way	2002-404	25
	5-way	2002-405	25
	6-way	2002-406	25
	7-way	2002-407	25
	8-way	2002-408	25
	9-way	2002-409	25
	10-way	2002-410	25











Push-in type jumper bar; insulated; I _N 25 A; light gray			
	1 to 3	2002-433	25
	1 to 4	2002-434	25
	1 to 5	2002-435	25
	1 to 6	2002-436	25
	1 to 7	2002-437	25
	1 to 8	2002-438	25
	1 to 9	2002-439	25
	1 to 10	2002-440	25





Delta jumper; insulated; I _N = I _N terminal block; light gray			
	1-2 3-4 5-6	2002-406/020-000	25



Star point jumper; insulated; I _N = I _N terminal block; light gray			
	1-3-5	2002-405/011-000	25

Adjacent jumper for continuous commoning; insulated; I _N 25 A; light gray			
	2-way	2002-400	25

Adjacent jumper for continuous commoning; insulated; I _N 25 A; 1 to 3			
	light gray	2002-423	25
	red	2002-423/000-005	25
	blue	2002-423/000-006	25

Staggered jumper; insulated; I _N 25 A; light gray			
	2-way	2002-472	25
	3-way	2002-473	25
	4-way	2002-474	25
	5-way	2002-475	25
	6-way	2002-476	25
	7-way	2002-477	25
	8-way	2002-478	25
	9-way	2002-479	25
	10-way	2002-480	25
	11-way	2002-481	25
	12-way	2002-482	25

Customized staggered jumper; insulated; with contact lugs broken off at the factory and circuit printing; I _N 25 A; light gray			
	1-3	2002-473/011-000	25
	1-3-5	2002-475/011-000	25
	1-3-5-7	2002-477/011-000	25
	1-3-5-7-9	2002-479/011-000	25
	1-3-5-7-9-11	2002-481/011-000	25

Push-in type wire jumper; insulated; 1.5 mm ² conductor cross-section; I _N 18 A			
	L = 60 mm	2009-412	100 (10)
	L = 110 mm	2009-414	100 (10)
	L = 250 mm	2009-416	100 (10)

Technical Data	
0.25 ... 2.5 (4) mm ² ①	22 ... 12 AWG
400 V/6 kV/3 ②	300 V, 15 A ③
I _N 16 A	300 V, 15 A ④
Terminal block width: 5.2 mm / 0.205 inch	
 10 ... 12 mm / 0.39 ... 0.47 inch	

Technical Data	
0.25 ... 2.5 (4) mm ² ①	22 ... 12 AWG
400 V/6 kV/3 ②	300 V, 15 A ③
I _N 16 A	300 V, 15 A ④
Terminal block width: 5.2 mm / 0.205 inch	
 10 ... 12 mm / 0.39 ... 0.47 inch	

- Conductor range: 0.25 ... 4 mm² "s+f-st"; Push-in termination: 1 ... 4 mm² "s" and 1 ... 2.5 mm² "insulated ferrules, 12 mm" Depending on the conductor characteristic, a conductor with a smaller cross section can also be inserted via push-in termination.
- 400 V = rated voltage
6 kV = rated impulse voltage
3 = pollution degree (see Section 15)
- Observe touch-proof protection for 42 V and higher voltages!
• 10 A (individual arrangement)
• 5 A (block arrangement)
- Terminal blocks with a blue insulated housing are suitable for Ex i applications.
- Terminal blocks with an Ex mark are suitable for Ex e II applications.
440 V; 17 A (see Section 15)

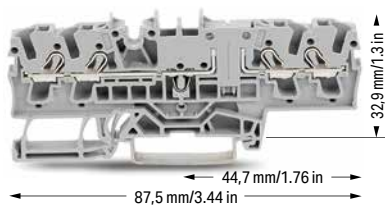
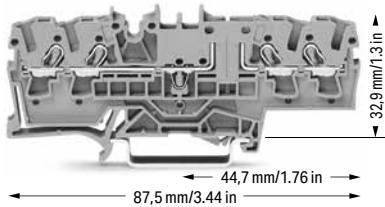

4-conductor carrier terminal block; with test point

4-conductor through terminal block; with test point; same profile as 4-conductor disconnect terminal block

Color	Item No.	VPE
○ gray ⑤	2002-1861 ⑤	50

Color	Item No.	VPE
○ gray ⑤	2002-1801 ⑤	50
● blue ⑤	2002-1804 ④ ⑤	50
● orange ⑤	2002-1802 ⑤	50

Other terminal blocks with the same profile:

Fuse	2002-1811	Page 113
------	-----------	----------

Accessories; item-specific
Disconnect plug for carrier terminal blocks; suitable when using a carrier terminal block as disconnect terminal block

	orange	2002-401	100 (25)
---	--------	----------	----------

Protective warning marker; with black high-voltage symbol; for 5 terminal blocks

	yellow	2002-115	100 (25)
---	--------	----------	----------

Marking strip; plain; 11 mm wide; 50 m reel

	white	2009-110	1
---	-------	----------	---

Modular connector; snaps together; for jumper contact slot

	gray	2002-511	100 (25)
---	------	----------	----------

WMB Inline; plain; 1,500 WMB markers (5 mm)/reel; stretchable 5 ... 5.2 mm

	white	2009-115	1
---	-------	----------	---

Spacer module; snaps together; bridges commoned terminal blocks

	gray	2002-549	100 (25)
---	------	----------	----------

WMB marker card; white; 10 strips with 10 markers/card; stretchable 5 ... 5.2 mm

	plain	793-5501	5
---	-------	----------	---

Blade-style fuses are not offered by WAGO.
Please observe the application notes:
Jumpers, from page 174
Testing accessories, from page 169
Marking, from page 640
Approvals and corresponding ratings, visit www.wago.com



Disconnect/test terminal block with pivoting knife disconnect and mechanical interlock – top view

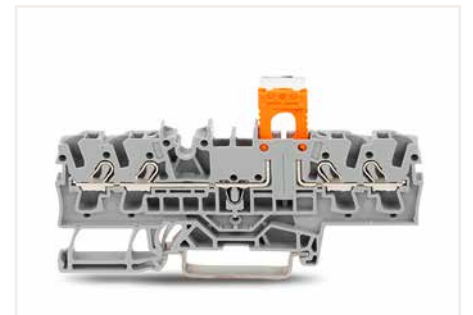

Carrier terminal block (2002-1861) with disconnect plug (2002-401) in parked position

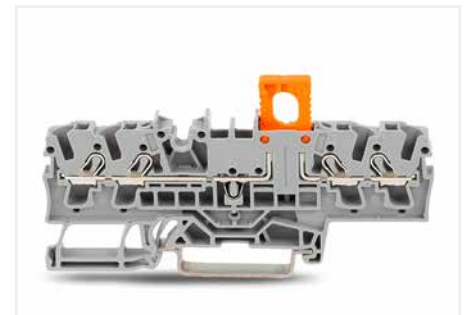



Carrier terminal block (2002-1861) with disconnect plug (2002-401) in operating position

Disconnect/Test Terminal Block, Fuse Terminal Block, Carrier Terminal Block, Through Terminal Block, Ground Conductor Terminal Block TOPJOB® S; with Additional Jumper Slot 2.5 (4) mm²; 2002 Series

1

Technical Data	
0.25 ... 2.5 (4) mm ² ①	22 ... 12 AWG
400 V/6 kV/3 ②	300 V, 15 A ③
I _N 16 A	300 V, 15 A ④
Terminal block width: 5.2 mm / 0.205 inch	
 10 ... 12 mm / 0.39 ... 0.47 inch	

Technical Data	
0.25 ... 2.5 (4) mm ² ①	22 ... 12 AWG
400 V/6 kV/3 ②	300 V, 15 A ③
I _N 16 A	300 V, 15 A ④
Terminal block width: 5.2 mm / 0.205 inch	
 10 ... 12 mm / 0.39 ... 0.47 inch	

Technical Data	
0.25 ... 2.5 (4) mm ² ①	22 ... 12 AWG
400 V/6 kV/3 ②	250 V, 10 A ③
I _N 10 A ④	250 V, 10 A ⑤
Terminal block width: 5.2 mm / 0.205 inch	
 10 ... 12 mm / 0.39 ... 0.47 inch	

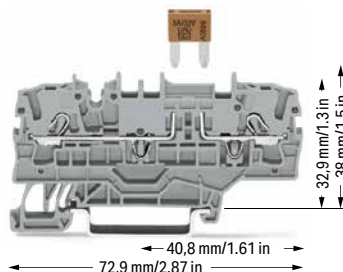
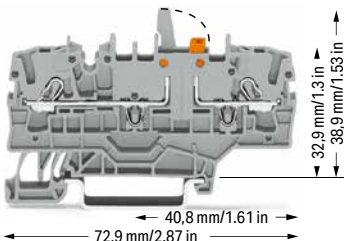
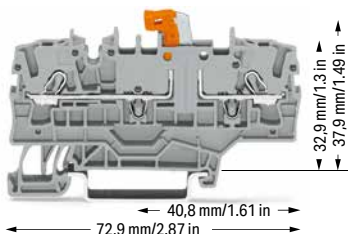

2-conductor disconnect/test terminal block; with test point; orange disconnect link; with additional jumper slot

2-conductor disconnect/test terminal block; with mechanical interlock; with test point; orange disconnect link; with additional jumper slot

2-conductor fuse terminal block; for mini-automotive blade-style fuse; with test point; without blown fuse indication; with additional jumper slot
Electrical ratings are given by the fuse. Blade-style fuses: Observe touch-proof protection for 42 V and higher voltages!



Color	Item No.	VPE
gray ⑤	2002-1971 ⑤	50
blue ⑤	2002-1974 ④ ⑤	50
orange ⑤	2002-1972 ⑤	50

Color	Item No.	VPE
gray ⑤	2002-1971/401-000 ⑤	50
blue ⑤	2002-1974/401-000 ④ ⑤	50
orange ⑤	2002-1972/401-000 ⑤	50

Color	Item No.	VPE
gray ⑤	2002-1981 ⑤	50

Accessories; 2002 Series

Appropriate marking systems: WMB/WMB Inline/Marking strips









End and intermediate plate; 1 mm thick			
	orange	2002-1992	100 (25)
	gray	2002-1991	100 (25)









Ex e/Ex i separator; orange; 3 mm thick			
	120 mm	209-191	50 (25)

Insulation stop; 5 pcs/strip; 0.25 ... 0.5 mm ²			
	light gray	2002-171	200 (25)











Insulation stop; 5 pcs/strip; 0.75 ... 1 mm ²			
	dark gray	2002-172	200 (25)





Delta jumper; insulated; I _N = I _N terminal block; light gray			
	1-2 3-4 5-6	2002-406/020-000	25

Push-in type jumper bar; insulated; I _N 25 A; light gray			
	2-way	2002-402	25
	3-way	2002-403	25
	4-way	2002-404	25
	5-way	2002-405	25
	6-way	2002-406	25
	7-way	2002-407	25
	8-way	2002-408	25
	9-way	2002-409	25
	10-way	2002-410	25

Push-in type jumper bar; insulated; I _N 25 A; light gray			
	1 to 3	2002-433	25
	1 to 4	2002-434	25
	1 to 5	2002-435	25
	1 to 6	2002-436	25
	1 to 7	2002-437	25
	1 to 8	2002-438	25
	1 to 9	2002-439	25
	1 to 10	2002-440	25

Star point jumper; insulated; I _N = I _N terminal block; light gray			
	1-3-5	2002-405/011-000	25

Staggered jumper; insulated; I _N 25 A; light gray			
	2-way	2002-472	25
	3-way	2002-473	25
	4-way	2002-474	25
	5-way	2002-475	25
	6-way	2002-476	25
	7-way	2002-477	25
	8-way	2002-478	25
	9-way	2002-479	25
	10-way	2002-480	25
	11-way	2002-481	25
	12-way	2002-482	25

Customized staggered jumper; insulated; with contact lugs broken off at the factory and circuit printing; I _N 25 A; light gray			
	1-3	2002-473/011-000	25
	1-3-5	2002-475/011-000	25
	1-3-5-7	2002-477/011-000	25
	1-3-5-7-9	2002-479/011-000	25
	1-3-5-7-9-11	2002-481/011-000	25

Technical Data

0.25 ... 2.5 (4) mm ² ①	22 ... 12 AWG
400 V/6 kV/3 ②	300 V, 15 A ③
I _N 16 A	300 V, 15 A ④

Terminal block width: 5.2 mm / 0.205 inch

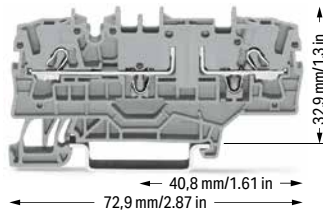
 10 ... 12 mm / 0.39 ... 0.47 inch



2-conductor carrier terminal block; with test point; with additional jumper slot

Color	Item No.	VPE
gray ⑤	2002-1961 ⑤	50

Technical Data

0.25 ... 2.5 (4) mm ² ①	22 ... 12 AWG
400 V/6 kV/3 ②	300 V, 15 A ③
I _N 16 A	300 V, 15 A ④

Terminal block width: 5.2 mm / 0.205 inch

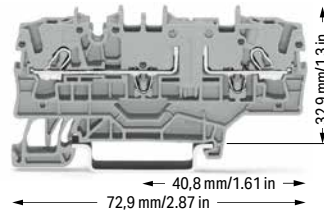
 10 ... 12 mm / 0.39 ... 0.47 inch

2-Leiter-Durchgangsklemme; mit Prüfmöglichkeit; with additional jumper slot; konturengleich zu 2-Leiter-Trennklemme

2-conductor through terminal block; with test point; same profile as 2-conductor disconnect terminal block

Color	Item No.	VPE
gray ⑤	2002-1901 ⑤	50
blue ⑤	2002-1904 ④ ⑤	50
orange ⑤	2002-1902 ⑤	50

2-conductor ground terminal block; mit Prüfmöglichkeit; with additional jumper slot

green-yellow ⑤	2002-1907 ⑤	50
----------------	-------------	----

Other terminal blocks with the same profile:

Fuse	2002-1911	Page 112
------	-----------	----------

Accessories; item-specific

Disconnect plug for carrier terminal blocks; suitable when using a carrier terminal block as disconnect terminal block



orange	2002-401	100 (25)
--------	----------	----------

Adjacent jumper for continuous commoning; insulated; I_N 25 A; light gray

2-way	2002-400	25
-------	----------	----

Adjacent jumper for continuous commoning; insulated; I_N 25 A; 1 to 3

light gray	2002-423	25
red	2002-423/000-005	25
blue	2002-423/000-006	25

Push-in type wire jumper; insulated; 1.5 mm² conductor cross-section; I_N 18 A

L = 60 mm	2009-412	100 (10)
L = 110 mm	2009-414	100 (10)
L = 250 mm	2009-416	100 (10)

Protective warning marker; with black high-voltage symbol; for 5 terminal blocks



yellow	2002-115	100 (25)
--------	----------	----------

Modular connector; snaps together; for jumper contact slot



gray	2002-511	100 (25)
------	----------	----------

① Conductor range: 0.25 ... 4 mm² "s+f-st"; Push-in termination: 1 ... 4 mm² "s" and 1 ... 2.5 mm² "insulated ferrules, 12 mm" Depending on the conductor characteristic, a conductor with a smaller cross section can also be inserted via push-in termination.

② 400 V = rated voltage
6 kV = rated impulse voltage
3 = pollution degree (see Section 15)

③ Observe touch-proof protection for 42 V and higher voltages!
• 10 A (individual arrangement)
• 5 A (block arrangement)

④ Terminal blocks with a blue insulated housing are suitable for Ex i applications.

⑤ Terminal blocks with an Ex mark are suitable for Ex e II applications.
440 V; 17 A (see Section 15)

Blade-style fuses are not offered by WAGO.

Please observe the application notes: Jumpers, from page 174 Testing accessories, from page 169 Marking, from page 640

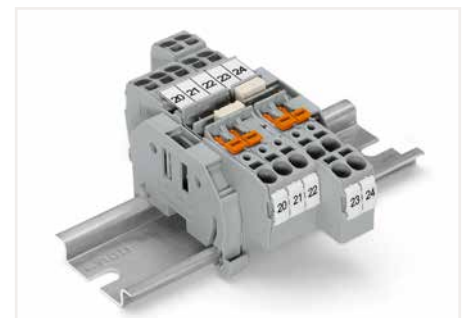
Approvals and corresponding ratings, visit www.wago.com

Through Terminal Blocks and Disconnect/Test Terminal Blocks

- One center and two side marker slots for WMB markers or marking strips
- Dual jumper slots in the same location as other 2002 Series terminal blocks
- Commoning options in front of or behind the knife disconnect, depending on the power supply direction

Marking strip; plain; 11 mm wide; 50 m reel



white	2009-110	1
-------	----------	---

WMB Inline; plain; 1,500 WMB markers (5 mm)/reel; stretchable 5 ... 5.2 mm



white	2009-115	1
-------	----------	---

WMB marker card; white; 10 strips with 10 markers/card; stretchable 5 ... 5.2 mm



plain	793-5501	5
-------	----------	---

Fuse Terminal Block TOPJOB® S; for Mini-Automotive Blade-Style Fuse; with Additional Jumper Slot

2.5 (4) mm²; 2002 Series

1

Technical Data	
0.25 ... 2.5 (4) mm ² ①	22 ... 12 AWG
400 V/6 kV/3 ②	12 V, 10 A ③
I _N 10 A ③	
Terminal block width: 5.2 mm / 0.205 inch	
10 ... 12 mm / 0.39 ... 0.47 inch	

Technical Data	
0.25 ... 2.5 (4) mm ² ①	22 ... 12 AWG
400 V/6 kV/3 ②	24 V, 10 A ③
I _N 10 A ③	
Terminal block width: 5.2 mm / 0.205 inch	
10 ... 12 mm / 0.39 ... 0.47 inch	

Technical Data	
0.25 ... 2.5 (4) mm ² ①	22 ... 12 AWG
400 V/6 kV/3 ②	48 V, 10 A ③
I _N 10 A ③	
Terminal block width: 5.2 mm / 0.205 inch	
10 ... 12 mm / 0.39 ... 0.47 inch	

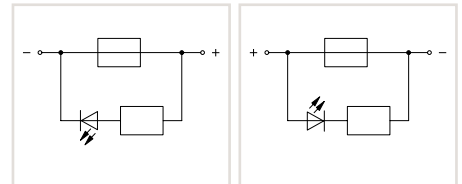
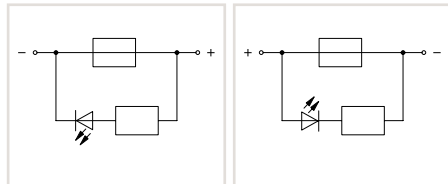
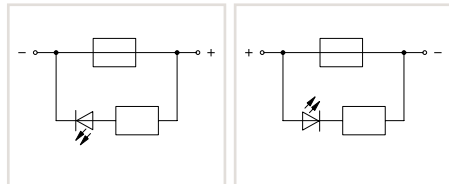
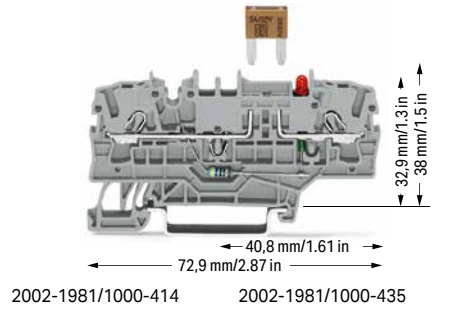
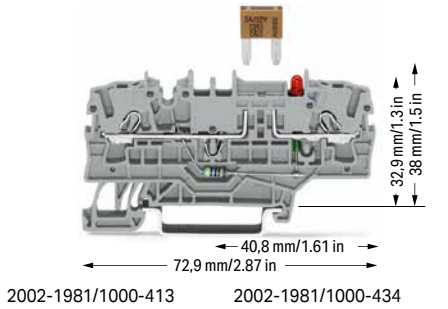
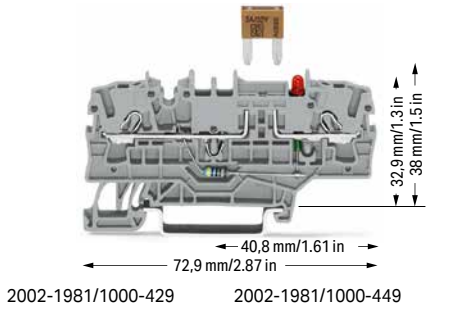

2-conductor fuse terminal block; for mini-automotive blade-style fuse; with test point; 12 V; with blown fuse indication by LED; LED power consumption: 4.8 mA; gray Electrical ratings are given by the fuse and blown fuse indication. Blade-style fuses: Observe touch-proof protection for 42 V and higher voltages!

2-conductor fuse terminal block; for mini-automotive blade-style fuse; with test point; 24 V; with blown fuse indication by LED; LED power consumption: 4.8 mA; gray Electrical ratings are given by the fuse and blown fuse indication. Blade-style fuses: Observe touch-proof protection for 42 V and higher voltages!

2-conductor fuse terminal block; for mini-automotive blade-style fuse; with test point; 48 V; with blown fuse indication by LED; LED power consumption: 4.8 mA; gray Electrical ratings are given by the fuse and blown fuse indication. Blade-style fuses: Observe touch-proof protection for 42 V and higher voltages!

	Item No.	Pack. Unit
○ anode right ④	2002-1981/1000-429 ④	50
○ anode left ④	2002-1981/1000-449 ④	50

	Item No.	Pack. Unit
○ anode right ④	2002-1981/1000-413 ④	50
○ anode left ④	2002-1981/1000-434 ④	50

	Item No.	Pack. Unit
○ anode right ④	2002-1981/1000-414 ④	50
○ anode left ④	2002-1981/1000-435 ④	50

Other terminal blocks with the same profile:		
Through	2002-1901	Page 111

Accessories; 2002 Series

Appropriate marking systems: WMB/WMB Inline/Marking strips

End and intermediate plate; 1 mm thick			
	orange	2002-1992	100 (25)
	gray	2002-1991	100 (25)

Ex e/Ex i separator; orange; 3 mm thick			
	120 mm	209-191	50 (25)

Insulation stop; 5 pcs/strip; 0.25 ... 0.5 mm ²			
	light gray	2002-171	200 (25)

Insulation stop; 5 pcs/strip; 0.75 ... 1 mm ²			
	dark gray	2002-172	200 (25)

Protective warning marker; with black high-voltage symbol; for 5 terminal blocks			
	yellow	2002-115	100 (25)

Push-in type wire jumper; insulated; 1.5 mm ² conductor cross-section; I _N 18 A			
	L = 60 mm	2009-412	100 (10)
	L = 110 mm	2009-414	100 (10)
	L = 250 mm	2009-416	100 (10)

Push-in type jumper bar; insulated; I _N 25 A; light gray			
	2-way	2002-402	25
	3-way	2002-403	25
	4-way	2002-404	25
	5-way	2002-405	25
	6-way	2002-406	25
	7-way	2002-407	25
	8-way	2002-408	25
	9-way	2002-409	25
	10-way	2002-410	25

Push-in type jumper bar; insulated; I _N 25 A; light gray			
	1 to 3	2002-433	25
	1 to 4	2002-434	25
	1 to 5	2002-435	25
	1 to 6	2002-436	25
	1 to 7	2002-437	25
	1 to 8	2002-438	25
	1 to 9	2002-439	25
	1 to 10	2002-440	25

Staggered jumper; insulated; I _N 25 A; light gray			
	2-way	2002-472	25
	3-way	2002-473	25
	4-way	2002-474	25
	5-way	2002-475	25
	6-way	2002-476	25
	7-way	2002-477	25
	8-way	2002-478	25
	9-way	2002-479	25
	10-way	2002-480	25
	11-way	2002-481	25
	12-way	2002-482	25

Adjacent jumper for continuous commoning; insulated; I _N 25 A; light gray			
	2-way	2002-400	25

Adjacent jumper for continuous commoning; insulated; I _N 25 A; 1 to 3			
	light gray	2002-423	25
	red	2002-423/000-005	25
	blue	2002-423/000-006	25

Technical Data

0.25 ... 2.5 (4) mm² ① | 22 ... 12 AWG

400 V/6 kV/3 ② | 250 V, 10 A ③

I_N 10 A ④

Terminal block width: 5.2 mm / 0.205 inch

10 ... 12 mm / 0.39 ... 0.47 inch

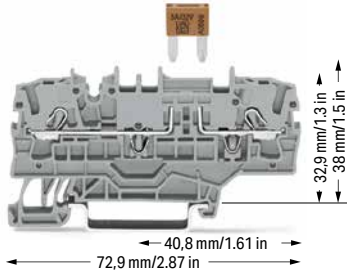

① Conductor range: 0.25 ... 4 mm² "s+f-st";
Push-in termination: 1 ... 4 mm² "s" and 1 ... 2.5 mm² "insulated ferrules, 12 mm"
Depending on the conductor characteristic, a conductor with a smaller cross section can also be inserted via push-in termination.

② 400 V = rated voltage
6 kV = rated impulse voltage
3 = pollution degree
(see Section 15)

③ Observe touch-proof protection for 42 V and higher voltages!
• 10 A (individual arrangement)
• 5 A (block arrangement)

④ Terminal blocks with an Ex mark are suitable for Ex e II applications.
440 V; 17 A
(see Section 15)

Blade-style fuses are not offered by WAGO.

Please observe the application notes:
Jumpers, from page 174
Testing accessories, from page 169
Marking, from page 640

Approvals and corresponding ratings,
visit www.wago.com



Selecting the correct fuse cartridge is important for product safety within applications, as well as for fuse cartridge service life and reliability. Fuse cartridges can operate perfectly as protection (break-off point) if they are properly selected and used according to manufacturer specifications.

Nominal current ratings for fuse cartridges are defined differently in international standards.

This is why the recommended continuous current-carrying capacity of the fuses is a max. 80% of their nominal current according to DIN 72581/Part 3 (for a surrounding air temperature of 23°C).

With regard to product safety, fuse cartridges must generally be tested both under normal and faulty operating conditions within your application.

2-conductor fuse terminal block; for mini-automotive blade-style fuse; with test point; without blown fuse indication; with additional jumper slot
Electrical ratings are given by the fuse. Blade-style fuses: Observe touch-proof protection for 42 V and higher voltages!

Color	Item No.	Pack. Unit
○ gray ④	2002-1981 ④	50

WMB Inline; plain; 1,500 WMB markers (5 mm)/reel; stretchable 5 ... 5.2 mm

 white	2009-115	1
---	----------	---

Marking strip; plain; 11 mm wide; 50 m reel

 white	2009-110	1
---	----------	---

WMB marker card; white; 10 strips with 10 markers/card; stretchable 5 ... 5.2 mm

 plain	793-5501	5
---	----------	---

Double-deck marker carrier; pivoting

 gray	2002-121	50 (25)
--	----------	---------

Fused Disconnect Terminal Block with Pivoting Fuse Holder TOPJOB® S; for 5 x 20 mm Glass Cartridge Fuse

2.5 (4) mm²; 2002 Series

1

Technical Data	
0.25 ... 2.5 (4) mm ² ①	22 ... 12 AWG
250 V/6 kV/3 ②	250 V, 10 A ③
I _N 6,3 A	250 V, 10 A ④
Klemmenbreite 6,2 mm / 0.244 inch	
10 ... 12 mm / 0.39 ... 0.47 inch	

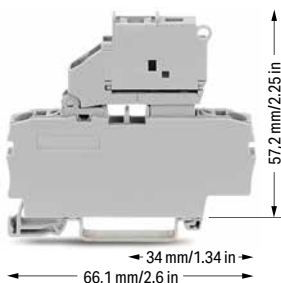

2-conductor fused disconnect terminal block with a pivoting fuse holder; for 5 x 20 mm glass cartridge fuse; without blown fuse indication
Electrical ratings are given by the fuse.

	Item No.	VPE
○ gray ⑤	2002-1611 ⑥	50

2-conductor fused disconnect terminal block with a pivoting fuse holder; for 5 x 20 mm glass cartridge fuse; with blown fuse indication by LED; gray
Electrical ratings are given by the fuse and blown fuse indication. Leakage current in case of a blown fuse: LED 2 mA

○ 12 ... 30 V ⑤	2002-1611/1000-541 ⑥	50
○ 30 ... 65 V ⑤	2002-1611/1000-542 ⑥	50
○ 120 V ⑤	2002-1611/1000-867 ⑥	50
○ 230 V ⑤	2002-1611/1000-836 ⑥	50

Technical Data	
0.25 ... 2.5 (4) mm ² ①	22 ... 12 AWG
250 V/6 kV/3 ②	250 V, 10 A ③
I _N 6,3 A	250 V, 10 A ④
Klemmenbreite 6,2 mm / 0.244 inch	
10 ... 12 mm / 0.39 ... 0.47 inch	

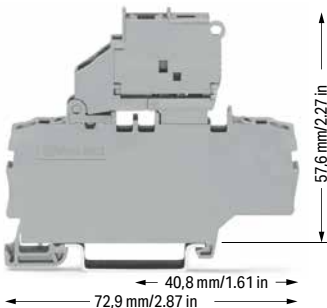

2-conductor fused disconnect terminal block with a pivoting fuse holder; with additional jumper slot; for 5 x 20 mm glass cartridge fuse; without blown fuse indication
Electrical ratings are given by the fuse.

	Item No.	VPE
○ gray ⑤	2002-1911 ⑥	50

2-conductor fused disconnect terminal block with a pivoting fuse holder; with additional jumper slot; for 5 x 20 mm glass cartridge fuse; with blown fuse indication by LED; gray
Electrical ratings are given by the fuse and blown fuse indication. Leakage current in case of a blown fuse: LED 2 mA

○ 12 ... 30 V ⑤	2002-1911/1000-541 ⑥	50
○ 30 ... 65 V ⑤	2002-1911/1000-542 ⑥	50
○ 120 V ⑤	2002-1911/1000-867 ⑥	50
○ 230 V ⑤	2002-1911/1000-836 ⑥	50

Accessories; item-specific

Push-in type wire jumper; insulated; 1.5 mm² conductor cross-section; I_N 18 A

	L = 60 mm	2009-412	100 (10)
	L = 110 mm	2009-414	100 (10)
	L = 250 mm	2009-416	100 (10)

Other terminal blocks with the same profile:		
Through	2002-1601	Page 105

Other terminal blocks with the same profile:		
Through	2002-1901	Page 111

Technical Data	
0.25 ... 2.5 (4) mm ² ①	22 ... 12 AWG
250 V/6 kV/3 ②	250 V, 10 A ③
I _N 6,3 A	250 V, 10 A ④
Klemmenbreite 6,2 mm / 0.244 inch	
10 ... 12 mm / 0.39 ... 0.47 inch	

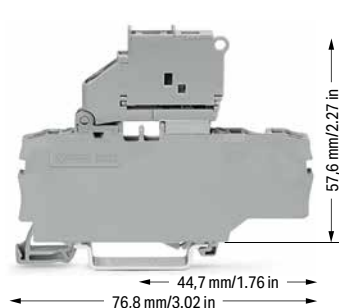

3-conductor fused disconnect terminal block with a pivoting fuse holder; for 5 x 20 mm glass cartridge fuse; without blown fuse indication
Electrical ratings are given by the fuse.

	Item No.	VPE
○ gray ⑤	2002-1711 ⑥	50

3-conductor fused disconnect terminal block with a pivoting fuse holder; for 5 x 20 mm glass cartridge fuse; with blown fuse indication by LED; gray
Electrical ratings are given by the fuse and blown fuse indication. Leakage current in case of a blown fuse: LED 2 mA

○ 12 ... 30 V ⑤	2002-1711/1000-541 ⑥	50
○ 30 ... 65 V ⑤	2002-1711/1000-542 ⑥	50
○ 120 V ⑤	2002-1711/1000-867 ⑥	50
○ 230 V ⑤	2002-1711/1000-836 ⑥	50

Other terminal blocks with the same profile:		
Through	2002-1701	Page 107

Accessories; 2002 Series

Appropriate marking systems: WMB/WMB Inline/Marking strips

End plate for fuse terminal blocks; 2 mm thick			
	orange	2002-992	100 (25)
	gray	2002-991	100 (25)

Insulation stop; 5 pcs/strip; 0.25 ... 0.5 mm ²			
	light gray	2002-171	200 (25)

Insulation stop; 5 pcs/strip; 0.75 ... 1 mm ²			
	dark gray	2002-172	200 (25)

Protective warning marker; with black high-voltage symbol; for 5 terminal blocks			
	yellow	2002-115	100 (25)

Push-in type jumper bar; insulated; I _N 32 A; light gray			
	2-way	2004-402	25
	3-way	2004-403	25
	4-way	2004-404	25
	5-way	2004-405	25
	6-way	2004-406	25
	7-way	2004-407	25
	8-way	2004-408	25
	9-way	2004-409	25
	10-way	2004-410	25

Push-in type jumper bar; insulated; I _N 32 A; light gray			
	1 to 3	2004-433	25
	1 to 4	2004-434	25
	1 to 5	2004-435	25
	1 to 6	2004-436	25
	1 to 7	2004-437	25
	1 to 8	2004-438	25
	1 to 9	2004-439	25
	1 to 10	2004-440	25

Interlocking link; mechanically locks multiple links; 1 m long

	transparent	210-254	1
--	-------------	---------	---

Marking strip; plain; 11 mm wide; 50 m reel

	white	2009-110	1
--	-------	----------	---

WMB marker card; white; 10 strips with 10 markers/card; stretchable 5 ... 5.2 mm

	plain	793-5501	5
--	-------	----------	---

Technical Data

0.25 ... 2.5 (4) mm ² ①	22 ... 12 AWG
250 V/6 kV/3 ②	250 V, 10 A ③
I _N 6,3 A	250 V, 10 A ③
Klemmenbreite 6,2 mm / 0.244 inch	
10 ... 12 mm / 0.39 ... 0.47 inch	



4-conductor fused disconnect terminal block with a pivoting fuse holder; for 5 x 20 mm glass cartridge fuse; without blown fuse indication
Electrical ratings are given by the fuse.

	Item No.	VPE
○ gray ④	2002-1811 ⑤	50

4-conductor fused disconnect terminal block with a pivoting fuse holder; for 5 x 20 mm glass cartridge fuse; with blown fuse indication by LED; gray
Electrical ratings are given by the fuse and blown fuse indication. Leakage current in case of a blown fuse: LED 2 mA

○ 12 ... 30 V ⑥	2002-1811/1000-541 ③	50
○ 30 ... 65 V ⑥	2002-1811/1000-542 ③	50
○ 120 V ⑥	2002-1811/1000-867 ③	50
○ 230 V ⑥	2002-1811/1000-836 ③	50

Other terminal blocks with the same profile:		
Through	2002-1801	Page 109

① Conductor range: 0.25 ... 4 mm² "s+f-st";
Push-in termination: 1 ... 4 mm² "s" and 1 ... 2.5 mm² "insulated ferrules, 12 mm"
Depending on the conductor characteristic, a conductor with a smaller cross section can also be inserted via push-in termination.

② 250 V = rated voltage
6 kV = rated impulse voltage
3 = pollution degree (see Section 15)

③ Terminal blocks with an Ex mark are suitable for Ex e II applications.
250 V; 6.3 A (see Section 15)

Please observe the application notes:
Jumpers, page 164
Marking, from page 640

A protective warning marker and an insulation stop must be applied individually. Due to the 6.2 mm width of fused disconnect terminal blocks with end plates, 2004 Series Push-In Type Jumper Bars must be used.

Approvals and corresponding ratings, visit www.wago.com



Fuse terminal blocks with a width of 6.2 mm can be assembled adjacently. If there is no adjacent fuse terminal block at the end of the assembly, an end plate must be used.

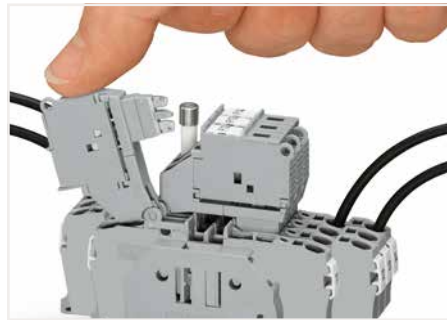

Fused disconnect terminal block with a pivoting fuse holder – pivoting the fuse holder into the locked open position.

Glass cartridge fuse 5 x 20

Series Item No.	Overload and short circuit protection		Short circuit protection only	
	Individual argmt.	Group argmt.	Individual argmt.	Group argmt.
Fuse terminal blocks				
2002-1611				
2002-1711	1.6 W	1.6 W	2.5 W	2.5 W
2002-1811				
2002-1611/.....				
2002-1711/.....	1.6 W	1.6 W	2.5 W	2.5 W
2002-1811/.....				

When selecting glass cartridge fuses, make sure that the maximum power loss listed below is not exceeded. The power loss is determined according to IEC or EN 60947-7-3/VDE 0611-6 at 23°C. The temperature rise of the terminal blocks must be checked according to their application and mounting. Higher ambient temperatures represent an additional impact on fuse cartridges. Therefore, in such applications, the rated current must be reduced if necessary. More details are available from the manufacturers.



Fused disconnect terminal block with a pivoting fuse holder – fuse replacement: Open the cover to replace the fuse.

Glass cartridge fuses 5 x 20

Series Item No.	Overload and short circuit protection		Short circuit protection only	
	Individual argmt.	Group argmt.	Individual argmt.	Group argmt.
Fuse terminal blocks				
2002-1911	1.6 W	1.6 W	2.5 W	2.5 W
2002-1911/.....	1.6 W	1.6 W	2.5 W	2.5 W

When selecting glass cartridge fuses, make sure that the maximum power loss listed below is not exceeded. The power loss is determined according to IEC or EN 60947-7-3/VDE 0611-6 at 23°C. The temperature rise of the terminal blocks must be checked according to their application and mounting. Higher ambient temperatures represent an additional impact on fuse cartridges. Therefore, in such applications, the rated current must be reduced if necessary. More details are available from the manufacturers.

Disconnect Terminal Block, Ground Conductor Disconnect Terminal Block, Carrier Terminal Block, Through Terminal Block TOPJOB® S

6 (10) mm²; 2006 Series

1

Technical Data	
0.5 ... 6 (10) mm ² ①	20 ... 8 AWG
800 V/8 kV/3 ②	600 V, 30 A ③
I _N 30 A	600 V, 30 A ④
Terminal block width: 7.5 mm / 0.295 inch	
 13 ... 15 mm / 0.51 ... 0.59 inch	

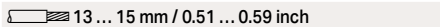
Technical Data	
0.5 ... 6 (10) mm ² ①	20 ... 8 AWG
Terminal block width: 7.5 mm / 0.295 inch	
 13 ... 15 mm / 0.51 ... 0.59 inch	

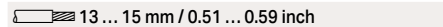
Technical Data	
0.5 ... 6 (10) mm ² ①	20 ... 8 AWG
800 V/8 kV/3 ②	600 V, 30 A ③
I _N 30 A	600 V, 30 A ④
Terminal block width: 7.5 mm / 0.295 inch	
 13 ... 15 mm / 0.51 ... 0.59 inch	

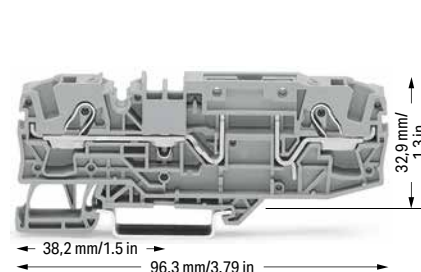
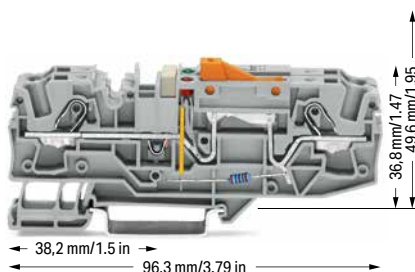
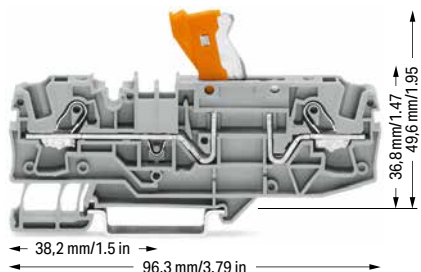

2-conductor disconnect terminal block; with test point; orange disconnect link

Color	Item No.	Pack. Unit
○ gray	2006-1671	25
● blue	2006-1674	25

Ground conductor disconnect terminal block; with test point; orange disconnect link; gray

	Item No.	Pack. Unit
○ 24 V	2006-1671/1000-848	12
○ 48 V	2006-1671/1000-849	12
○ 120 V	2006-1671/1000-850	12
○ 230 V	2006-1671/1000-851	12





2-conductor carrier terminal block; with test point

Color	Item No.	Pack. Unit
○ gray	2006-1661	25
● blue	2006-1664	25





Other terminal blocks with the same profile:		
Through	2006-1601	Page 117



Other terminal blocks with the same profile:		
Through	2006-1601	Page 117



Other terminal blocks with the same profile:		
Through	2006-1601	Page 117

Accessories; item-specific			
Push-in type jumper bar; insulated; I _N 41 A; light gray			
	2-way	2006-402	25
	3-way	2006-403	25
	4-way	2006-404	25
	5-way	2006-405	25

Accessories; item-specific			
Push-in type jumper bar; insulated; I _N 41 A; light gray			
	2-way	2006-402	25

Accessories; item-specific			
Push-in type jumper bar; insulated; I _N 41 A; light gray			
	2-way	2006-402	25
	3-way	2006-403	25
	4-way	2006-404	25
	5-way	2006-405	25

Push-in type jumper bar; insulated; I _N 41 A; light gray			
	1 to 3	2006-433	25
	1 to 4	2006-434	25
	1 to 5	2006-435	25

Push-in type jumper bar; insulated; I _N 41 A; light gray			
	1 to 3	2006-433	25
	1 to 4	2006-434	25
	1 to 5	2006-435	25

Star point jumper; insulated; I _N = I _N terminal block; light gray			
	1-3-5	2006-405/011-000	25

Star point jumper; insulated; I _N = I _N terminal block; light gray			
	1-3-5	2006-405/011-000	25

Disconnect plug for carrier terminal blocks; suitable when using a carrier terminal block as disconnect terminal block



	orange	2006-401	100 (25)
---	--------	----------	----------

Blind plug for carrier terminal block; indicates a disconnection

	red	2006-451	100 (25)
---	-----	----------	----------

Accessories; 2006 Series

Appropriate marking systems: WMB/Marking strips

End and intermediate plate; 1 mm thick			
	orange	2006-1692	100 (25)
	gray	2006-1691	100 (25)

Lockout cap; for conductor entry and operating slot			
	gray	2006-191	25

Protective warning marker; with black high-voltage symbol; for 5 terminal blocks			
	yellow	2006-115	100 (25)

Technical Data

0.5 ... 6 (10) mm ² ①	20 ... 8 AWG
800 V/8 kV/3 ②	600 V, 30 A ③
I _N 30 A	600 V, 30 A ④
Terminal block width: 15 mm / 0.591 inch	
13 ... 15 mm / 0.51 ... 0.59 inch	

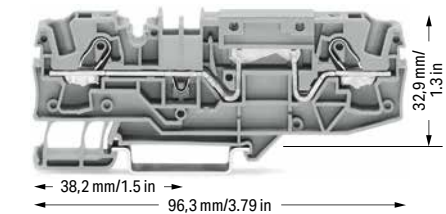

2-conductor through terminal block; with test point; same profile as 2-conductor disconnect terminal block

Color	Item No.	Pack. Unit
gray	2006-1601	25
blue	2006-1604	25

Other terminal blocks with the same profile:

Carrier	2006-1661	Page 116
Fuse	2006-1681	Page 118
Disconnect	2006-1671	Page 116

Accessories; item-specific

Push-in type jumper bar; insulated; I_N 41 A; light gray

	2-way	2006-402	25
	3-way	2006-403	25
	4-way	2006-404	25
	5-way	2006-405	25

Push-in type jumper bar; insulated; I_N 41 A; light gray

	1 to 3	2006-433	25
	1 to 4	2006-434	25
	1 to 5	2006-435	25

Star point jumper; insulated; I_N = I_N terminal block; light gray

	1-3-5	2006-405/011-000	25
--	-------	------------------	----

Double-deck marker carrier; pivoting

	gray	2002-121	50 (25)
--	------	----------	---------

① Conductor range: 0.5 ... 10 mm² "s+f-st"; Push-in termination: 2.5 ... 10 mm² "s" and 2.5 ... 6 mm² "insulated ferrules; 12 mm"
Depending on the conductor characteristic, a conductor with a smaller cross section can also be inserted via push-in termination.

② 800 V = rated voltage
8 kV = rated impulse voltage
3 = pollution degree (see Section 15)

Please observe the application notes:
Jumpers, from page 177
Marking, from page 640

Approvals and corresponding ratings, visit www.wago.com

IEC 60204/DIN VDE 0113 "Safety of machinery – Electrical equipment of machines – Part 1: General requirements," Section 9.4.3.1:

Ground faults on control circuits must not cause unintentional starting, hazardous movements, or prevent stopping of the machine.

In order to fulfill this requirement, a connection to the protective bonding circuit must be provided in accordance with Section 8.2 and the devices must be connected as described in Section 9.1.4. Control circuits fed from a transformer and not connected to the protective bonding circuit must be provided with an insulation monitoring device (e.g., residual current device), which either indicates a ground fault or interrupts the circuit automatically after a ground fault.

In the case of electronic circuits, the connection of one side of the control circuit to the protective bonding circuit in accordance with Section 9.1.4 can prevent unintentional operation. When this does not help, or if due to other reasons that electronic circuits cannot be connected to the protective bonding circuit, other measures must be taken to achieve the same level of safety.

Multipole control switches that interrupt all live conductors must be used where the control circuit is directly connected between the phase conductors of the supply or between a phase conductor and a neutral conductor, which is either not grounded or grounded through a high impedance. This is required for starting or stopping machine functions, which can cause a hazardous situation including: damaging the machine or halting work in progress in the event of unintentional starting or failure to stop.

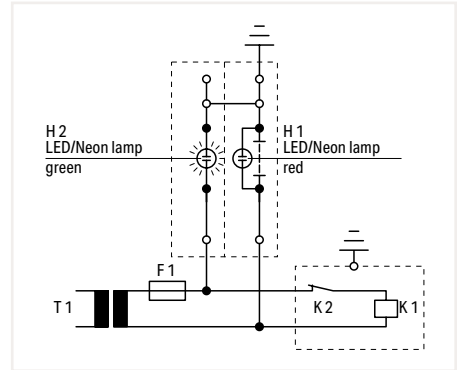

Operating condition
Slide link closed, auxiliary circuit grounded, green LED/neon lamp illuminates.

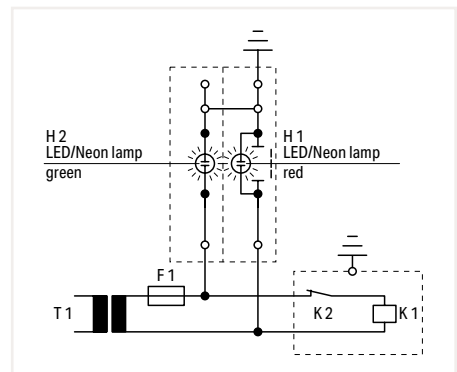

Test condition – no grounding
Slide link open, auxiliary circuit not grounded.

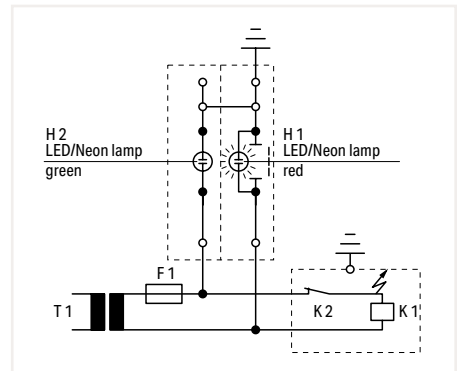

Test condition – grounding
Slide link open, auxiliary circuit not grounded, red LED/neon lamp illuminates.



Ground conductor disconnect terminal block – top view

Fuse Terminal Block for Automotive Blade-Style Fuse TOPJOB® S 6 (10) mm²; 2006 Series

1

Technical Data	
0.5 ... 6 (10) mm ² ①	20 ... 8 AWG
500 V/6 kV/3 ②	12 V, 30 A
I _N 25 A (30 A) ③	12 V, 30 A
Terminal block width: 7.5 mm / 0.295 inch	
13 ... 15 mm / 0.51 ... 0.59 inch	

Technical Data	
0.5 ... 6 (10) mm ² ①	20 ... 8 AWG
500 V/6 kV/3 ②	24 V, 30 A
I _N 25 A (30 A) ③	24 V, 30 A
Terminal block width: 7.5 mm / 0.295 inch	
13 ... 15 mm / 0.51 ... 0.59 inch	

Technical Data	
0.5 ... 6 (10) mm ² ①	20 ... 8 AWG
500 V/6 kV/3 ②	48 V, 30 A
I _N 25 A (30 A) ③	48 V, 30 A
Terminal block width: 7.5 mm / 0.295 inch	
13 ... 15 mm / 0.51 ... 0.59 inch	

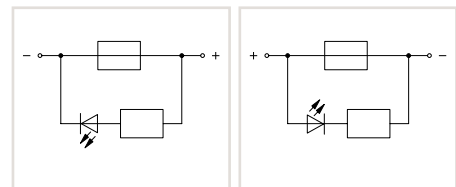
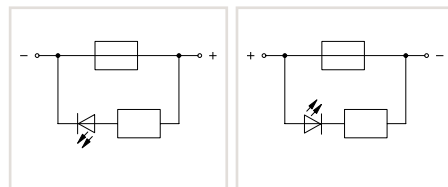
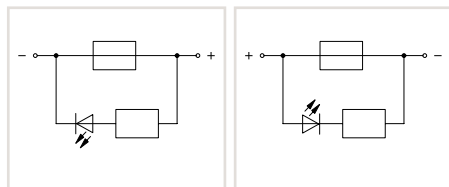
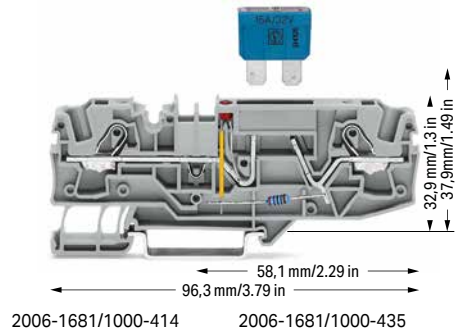
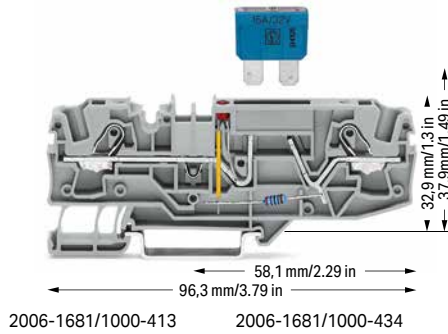
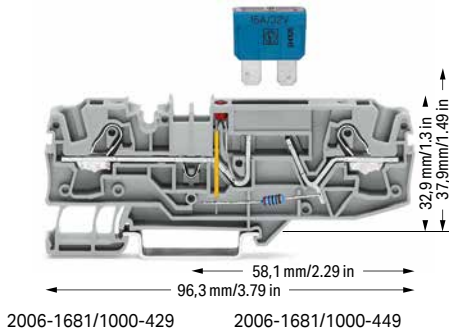

2-conductor fuse terminal block for automotive blade-style fuse; with test point; 12 V; with blown fuse indication by LED; LED power consumption: 4.8 mA
Electrical ratings are given by the fuse and blown fuse indication. Blade-style fuses: Observe touch-proof protection for 42 V and higher voltages!

2-conductor fuse terminal block for automotive blade-style fuse; with test point; 24 V; with blown fuse indication by LED; LED power consumption: 4.8 mA
Electrical ratings are given by the fuse and blown fuse indication. Blade-style fuses: Observe touch-proof protection for 42 V and higher voltages!

2-conductor fuse terminal block for automotive blade-style fuse; with test point; 48 V; with blown fuse indication by LED; LED power consumption: 4.8 mA
Electrical ratings are given by the fuse and blown fuse indication. Blade-style fuses: Observe touch-proof protection for 42 V and higher voltages!

Color	Item No.	Pack. Unit
gray	2006-1681/1000-429	25
gray	2006-1681/1000-449	25

Color	Item No.	Pack. Unit
gray	2006-1681/1000-413	25
gray	2006-1681/1000-434	25

Color	Item No.	Pack. Unit
gray	2006-1681/1000-414	25
gray	2006-1681/1000-435	25

Other terminal blocks with the same profile:		
Through	2006-1601	Page 117

Accessories; 2006 Series

End and intermediate plate; 1 mm thick			
	orange	2006-1692	100 (25)
	gray	2006-1691	100 (25)

Push-in type jumper bar; insulated; I _N 41 A; light gray			
	2-way	2006-402	25
	3-way	2006-403	25
	4-way	2006-404	25
	5-way	2006-405	25

Push-in type jumper bar; insulated; I _N 41 A; light gray			
	1 to 3	2006-433	25
	1 to 4	2006-434	25
	1 to 5	2006-435	25

Protective warning marker; with black high-voltage symbol; for 5 terminal blocks			
	yellow	2006-115	100 (25)

Appropriate marking systems: WMB/Marking strips

Marking strip; plain; 11 mm wide; 50 m reel			
	white	2009-110	1

WMB marking card; white; 10 strips with 10 markers/card; 5 ... 5.2 mm stretchable			
	plain	793-5501	5

Double-deck marker carrier; pivoting			
	gray	2002-121	50 (25)

Technical Data

0.5 ... 6 (10) mm ² ①	20 ... 8 AWG
500 V/6 kV/3 ②	600 V, 30 A ③
I _N 25 A (30 A)	600 V, 30 A ③
Terminal block width: 7.5 mm / 0.295 inch	
13 ... 15 mm / 0.51 ... 0.59 inch	

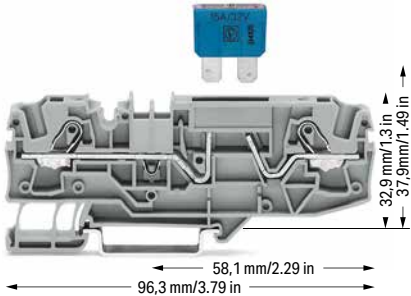

① Conductor range: 0.5 ... 10 mm² "s+f-st"; Push-in termination: 2.5 ... 10 mm² "s" and 2.5 ... 6 mm² "insulated ferrules; 12 mm" Depending on the conductor characteristic, a conductor with a smaller cross section can also be inserted via push-in termination.

② 500 V = rated voltage
6 kV = rated impulse voltage
3 = pollution degree (see Section 15)

③ LED power consumption: 4.8 mA

Blade-style fuses are not offered by WAGO. Thermal automotive circuit breakers are not offered by WAGO. WAGO recommends automotive circuit breakers from ETA.

Please observe the application notes: Marking, from page 640

Approvals and corresponding ratings, visit www.wago.com

2-conductor fuse terminal block for automotive blade-style fuse; with test point; without blown fuse indication; Electrical ratings are given by the fuse. Blade-style fuses: Observe touch-proof protection for 42 V and higher voltages!

Color	Item No.	Pack. Unit
○ gray	2006-1681	25

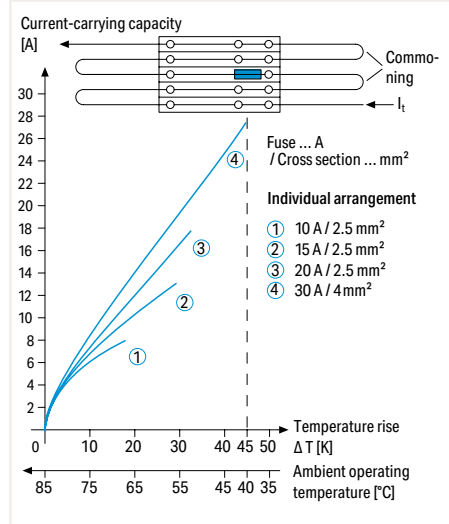

Application Notes on Fuse Terminal Blocks
Diagram: Individual arrangement

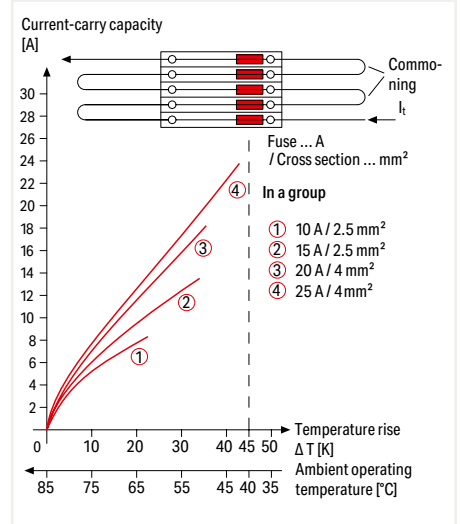

Application Notes on Fuse Terminal Blocks
Diagram: Block arrangement

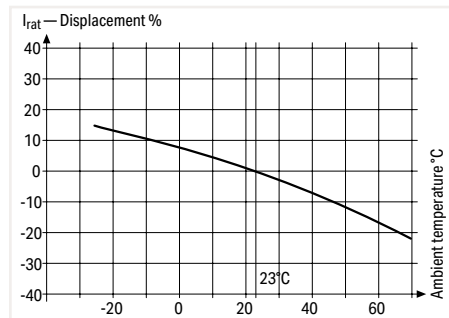

Application Notes on Fuse Terminal Blocks
Nominal current ratings for fuse cartridges are defined differently in international standards. This is why the recommended continuous current-carrying capacity of the fuses is a max. 80% of their nominal current according to DIN 72581/Part 3 (for an surrounding air temperature of 23°C).
Selecting the correct fuse cartridge is important for product safety within applications, as well as for fuse cartridge service life and reliability. Fuse cartridges will only operate perfectly as protection components (break-off point) if they are properly selected and used as intended (i.e., according to the state of the technology and valid specifications, as well as data sheet characteristics), according to basic safety requirements (i.e., persons, animals and property must be protected against hazards).

Information from the mini-automotive, blade-type fuse manufacturers

Derating T _{amb} / °C	%	F _T
-25	14	0.877
-20	13	0.885
-15	12	0.893
-10	11	0.901
- 5	10	0.909
0	9	0.917
5	8	0.926
10	6	0.943
15	4	0.962
20	2	0.980
23	0	1.000
30	- 2	1.020
35	- 4	1.042
40	- 6	1.064
45	- 8	1.087
50	-10	1.111
55	-13	1.149
60	-16	1.190
65	-19	1.235
70	-22	1.282

With regard to product safety, fuse cartridges must generally be tested both under normal and faulty operating conditions within your application.

PUSH-IN CAGE CLAMP®

Fused Disconnect Terminal Block with Pivoting Fuse Holder TOPJOB® S; for 5 x 20 mm, 5 x 30 mm and ¼" x 1¼" Glass Cartridge Fuse 6 (10) mm²; 2006 Series

1

Technical Data	
0.5 ... 6 (10) mm ² ①	20 ... 8 AWG
800 V/8 kV/3 ②	600 V, 15 A ③
I _N 10 A	600 V, 15 A ④
Terminal block width: 7.5 mm / 0.295 inch	
13 ... 15 mm / 0.51 ... 0.59 inch	

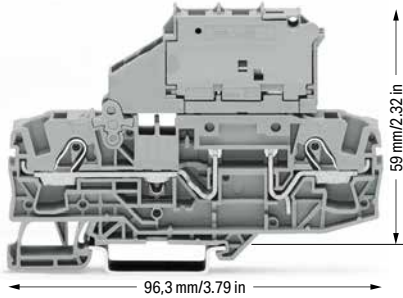

Technical Data	
0.5 ... 6 (10) mm ² ①	20 ... 8 AWG
800 V/8 kV/3 ②	30 V, 15 A ③
I _N 10 A	30 V, 15 A ④
Terminal block width: 7.5 mm / 0.295 inch	
13 ... 15 mm / 0.51 ... 0.59 inch	

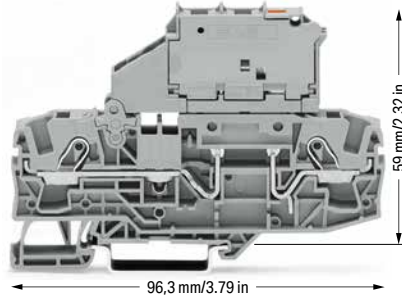

① Conductor range: 0.5 ... 10 mm² "s+f-st"; Push-in termination: 2.5 ... 10 mm² "s" and 2.5 ... 6 mm² "insulated ferrules; 12 mm" Depending on the conductor characteristic, a conductor with a smaller cross section can also be inserted via push-in termination.

② 800 V = rated voltage
8 kV = rated impulse voltage
3 = pollution degree (see Section 15)

Please observe the application notes:
Jumpers, from page 177
Marking, from page 640

Approvals and corresponding ratings, visit www.wago.com

2-conductor fused disconnect terminal block with a pivoting fuse holder; without blown fuse indication
Electrical ratings are given by the fuse.

for 5 x 20 mm glass cartridge fuse

Color	Item No.	Pack. Unit
○ gray	2006-1611	25

for 5 x 30 mm glass cartridge fuse

○ gray	2006-1621	25
--------	-----------	----

for ¼" x 1¼" glass cartridge fuse

○ gray	2006-1631	25
--------	-----------	----

Other terminal blocks with the same profile:

Through	2006-1601	Page 117
---------	-----------	----------

2-conductor fused disconnect terminal block with a pivoting fuse holder; gray; with blown fuse indication by LED
Electrical ratings are given by the fuse and blown fuse indication. Leakage current in case of a blown fuse: LED 2 mA

for 5 x 20 mm glass cartridge fuse

	Item No.	Pack. Unit
○ 12 ... 30 V	2006-1611/1000-541	25
○ 30 ... 65 V	2006-1611/1000-542	25
○ 120 V	2006-1611/1000-867	25
○ 230 V	2006-1611/1000-836	25

for 5 x 30 mm glass cartridge fuse

○ 12 ... 30 V	2006-1621/1000-541	25
○ 30 ... 65 V	2006-1621/1000-542	25
○ 230 V	2006-1621/1000-836	25
○ 380 ... 500 V	2006-1621/1000-859	25

for ¼" x 1¼" glass cartridge fuse

○ 12 ... 30 V	2006-1631/1000-541	25
○ 30 ... 65 V	2006-1631/1000-542	25
○ 120 V	2006-1631/1000-867	25
○ 230 V	2006-1631/1000-836	25
○ 380 ... 500 V	2006-1631/1000-859	25

Other terminal blocks with the same profile:

Through	2006-1601	Page 117
---------	-----------	----------

Accessories; 2006 Series

Appropriate marking systems: WMB/Marking strips

End and intermediate plate; 1 mm thick

orange	2006-1692	100 (25)
gray	2006-1691	100 (25)

End plate for fuse terminal blocks; 2 mm thick

orange	2006-992	100 (25)
gray	2006-991	100 (25)

Push-in type jumper bar; insulated; I_N 41 A; light gray

2-way	2006-402	25
3-way	2006-403	25
4-way	2006-404	25
5-way	2006-405	25

Push-in type jumper bar; insulated; I_N 41 A; light gray

1 to 3	2006-433	25
1 to 4	2006-434	25
1 to 5	2006-435	25

Star point jumper; insulated; I_N = I_N terminal block; light gray

1-3-5	2006-405/011-000	25
-------	------------------	----

Protective warning marker; with black high-voltage symbol; for 5 terminal blocks

yellow	2006-115	100 (25)
--------	----------	----------

Test plug; with 500 mm cable; 2 mm Ø; max. 42 V

red	210-136	50 (1)
-----	---------	--------

WMB marking card; white; 10 strips with 10 markers/card; 5 ... 5.2 mm stretchable

plain	793-5501	5
-------	----------	---



Fused disconnect terminal block with a pivoting fuse holder - pivoting the fuse holder into the locked open position.

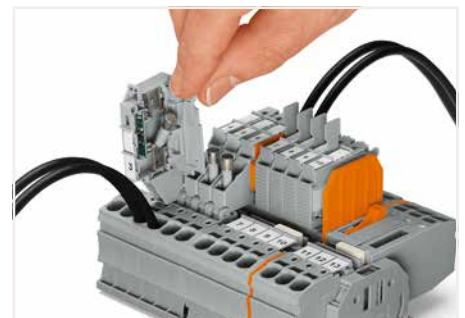

Fused disconnect terminal block with a pivoting fuse holder - fuse replacement: Open the cover to replace the fuse.

Fused Disconnect Terminal Block with Pivoting Fuse Holder TOPJOB® S; for ¼" x 1¼" Glass Cartridge Fuse

6 (10) mm²; 2006 Series

Technical Data

0.5 ... 6 (10) mm ² ①	20 ... 8 AWG
800 V/8 kV/3 ②	600 V, 15 A ^{III}
I _N 10 A	600 V, 15 A [Ⓞ]
Terminal block width: 10.4 mm / 0.409 inch	
13 ... 15 mm / 0.51 ... 0.59 inch	



Fused disconnect terminal block with a pivoting fuse holder and end plate; without blown fuse indication
Electrical ratings are given by the fuse.

for ¼" x 1¼" glass cartridge fuse

Color	Item No.	Pack. Unit
○ gray	2006-1631/099-000	25

Technical Data

0.5 ... 6 (10) mm ² ①	20 ... 8 AWG
800 V/8 kV/3 ②	30 V, 15 A ^{III}
I _N 10 A	30 V, 15 A [Ⓞ]
Terminal block width: 10.4 mm / 0.409 inch	
13 ... 15 mm / 0.51 ... 0.59 inch	



Fused disconnect terminal block with a pivoting fuse holder and end plate; gray; with blown fuse indication by LED
Electrical ratings are given by the fuse and blown fuse indication. Leakage current in case of a blown fuse: LED 2 mA

for ¼" x 1¼" glass cartridge fuse

	Item No.	Pack. Unit
○ 12 ... 30 V	2006-1631/1099-541	25
○ 30 ... 65 V	2006-1631/1099-542	25
○ 120 V	2006-1631/1099-867	25
○ 230 V	2006-1631/1099-836	25
○ 380 ... 500 V	2006-1631/1099-859	25

Other terminal blocks with the same profile:

Through	2006-1601	Page 117
---------	-----------	----------

Other terminal blocks with the same profile:

Through	2006-1601	Page 117
---------	-----------	----------

Accessories; 2006 Series

Appropriate marking systems: WMB/Marking strips

End plate for fuse terminal blocks; 2 mm thick

	orange	2006-992	100 (25)
	gray	2006-991	100 (25)

Push-in type jumper bar; insulated; I_N 25 A; light gray

	1 to 3	2002-433	25
	1 to 5	2002-435	25
	1 to 7	2002-437	25
	1 to 9	2002-439	25

Star point jumper; insulated; I_N = I_N terminal block; light gray

	1-3-5	2002-405/011-000	25
---	-------	------------------	----

Test plug; with 500 mm cable; 2 mm Ø; max. 42 V

	red	210-136	50 (1)
---	-----	---------	--------

WMB marking card; white; 10 strips with 10 markers/card; 5 ... 5.2 mm stretchable

	plain	793-5501	5
---	-------	----------	---

① Conductor range: 0.5 ... 10 mm² "s+f-st";
Push-in termination: 2.5 ... 10 mm² "s" and
2.5 ... 6 mm² "insulated ferrules; 12 mm"
Depending on the conductor characteristic, a conductor
with a smaller cross section can also be inserted
via push-in termination.

② 800 V = rated voltage
8 kV = rated impulse voltage
3 = pollution degree
(see Section 15)

Please observe the application notes:
Jumpers, from page 177
Marking, from page 640

Approvals and corresponding ratings,
visit www.wago.com

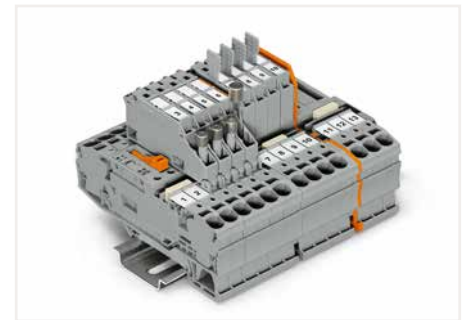

Pivoting fuse holder with spare fuse holder

Glass cartridge fuses

Series Item No.	Overload and short circuit protection		Short circuit protection only	
	Individual argmt.	Group argmt.	Individual argmt.	Group argmt.
Fused disconnect terminal blocks				
2006-1611	7.5	1.6 W	1.6 W	2.5 W
2006-1621	7.5	1.6 W	1.6 W	2.5 W
2006-1631	7.5	1.6 W	1.6 W	2.5 W
2006-1631 /099-...	10.4	2.5 W	2.5 W	2.5 W
2006-1631 /1099-...	10.4	2.5 W	2.5 W	2.5 W

When selecting glass cartridge fuses, make sure that the maximum power loss listed below is not exceeded. The power loss is determined according to IEC or EN 60947-7-3/VDE 0611-6 at 23°C. The temperature rise of the terminal blocks must be checked according to their application and mounting. Higher ambient temperatures represent an additional impact on fuse cartridges. Therefore, in such applications, the rated current must be reduced if necessary. More details are available from the manufacturers.

Disconnect/Test Terminal Block, Carrier Terminal Block, Through Terminal Block TOPJOB® S 6 (10) mm²; 2006 Series

1

Technical Data	
0.5 ... 6 (10) mm ² ①	20 ... 8 AWG
1000 VAC/DC / 1500 VDC / 12 kV / 3 ②	
I _N 30 A 600 V, 30 A ^{VA} ; 1000 V, 30 A ^{VE}	
Terminal block width: 15 mm / 0.591 inch	
 13 ... 15 mm / 0.51 ... 0.59 inch	

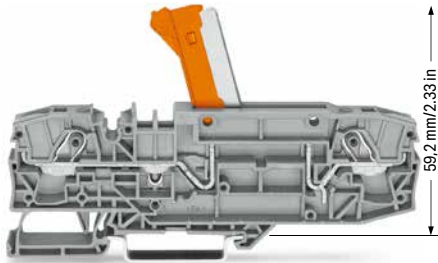

2-conductor disconnect/test terminal block; with test point; orange disconnect link

Color	Item No.	Pack. Unit
○ gray	2006-8671	12
● blue	2006-8674	12

Technical Data	
0.5 ... 6 (10) mm ² ①	20 ... 8 AWG
1000 VAC/DC / 1500 VDC / 12 kV / 3 ②	
I _N 30 A 600 V, 30 A ^{VA} ; 1000 V, 30 A ^{VE}	
Terminal block width: 15 mm / 0.591 inch	
 13 ... 15 mm / 0.51 ... 0.59 inch	

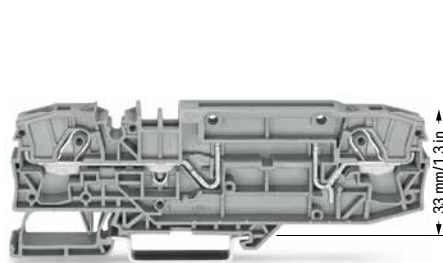

2-conductor carrier terminal block; with test point

Color	Item No.	Pack. Unit
○ gray	2006-8661	12
● blue	2006-8664	12

Accessories; item-specific
Disconnect plug for carrier terminal blocks; suitable when using a carrier terminal block as disconnect terminal block



orange	2006-8401	48 (12)
--------	-----------	---------

Technical Data	
0.5 ... 6 (10) mm ² ①	20 ... 8 AWG
1000 VAC/DC / 1500 VDC / 12 kV / 3 ②	
I _N 30 A 600 V, 30 A ^{VA} ; 1000 V, 30 A ^{VE}	
Terminal block width: 15 mm / 0.591 inch	
 13 ... 15 mm / 0.51 ... 0.59 inch	

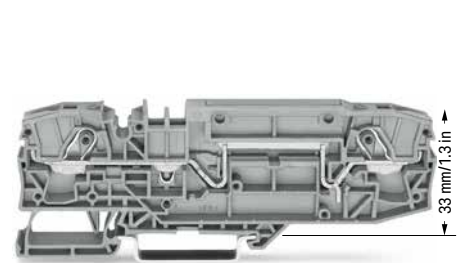

2-conductor through terminal block; with test point; same profile as 2-conductor disconnect terminal block

Color	Item No.	Pack. Unit
○ gray	2006-8601	12
● blue	2006-8604	12

Accessories; 2006 Series

Appropriate marking systems: WMB/Marking strips

End and intermediate plate; 1 mm thick

 orange	2006-8692	48 (12)
 gray	2006-8691	48 (12)

Protective warning marker; with black high-voltage symbol; for 5 terminal blocks

 yellow	2006-115	100 (25)
---	----------	----------

Push-in type jumper bar; insulated; I_N 41 A; light gray

 1 to 3	2006-433	25
 1 to 5	2006-435	25

Lockout cap; for conductor entry and operating slot

 gray	2006-191	25
---	----------	----

Marking strip; plain; 11 mm wide; 50 m reel

 white	2009-110	1
--	----------	---

WMB marking card; white; 10 strips with 10 markers/card; 5 ... 5.2 mm stretchable

 plain	793-5501	5
--	----------	---

- ❶ Conductor range: 0.5 ... 10 mm² "s+f-st";
Push-in termination: 2.5 ... 10 mm² "s" and
2.5 ... 6 mm² "insulated ferrules; 12 mm"
Depending on the conductor characteristic, a conductor
with a smaller cross section can also be inserted
via push-in termination.
 - ❷ 1000 VAC/DC = rated voltage
1500 VDC
12 kV = rated impulse voltage
3 = pollution degree
(see Section 15)
- Please observe the application notes:
Marking, from page 640
- Protective warning markers must be applied individ-
ually.
- Approvals and corresponding ratings,
visit www.wago.com

Both 2006-8671 and 2006-8661 Disconnect Terminal Blocks are specially designed for use in photovoltaic and wind power systems, where voltages exceeding 1,000 V (IEC) and 600 V (UL) occur (e.g., generator junction boxes).

- Ideal for high voltages in renewable energy applications
- **Disconnect terminal blocks with two alternative disconnect options:**
 - with orange knife disconnect (2006-8671)
 - with orange disconnect plug (2006-8661)
- These 2006 Series terminal blocks are approved for 1,500 VDC (IEC) or 1,000 VDC (UL) and 30 A.
- With a terminal block width of 15 mm, the maximum cross-section for solid and fine-stranded conductors is 10 mm² (AWG 8) and 6 mm² (AWG 10) for ferruled conductors.
- Equipped with two test slots
- Compatible with through terminal blocks of the same profile and all other terminal blocks TOPJOB® S

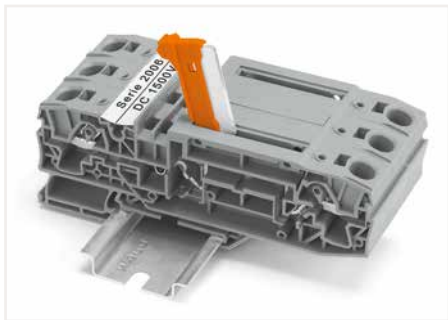

Disconnect/test terminal block with knife disconnect (2006-8671) in disconnect position

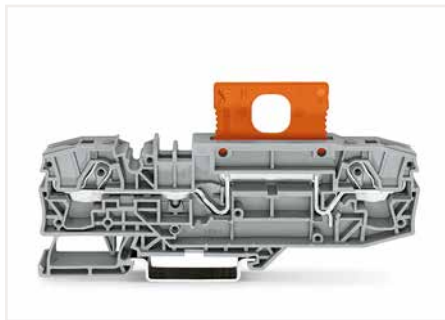

Carrier terminal block with disconnect plug (2006-8401) in operating position

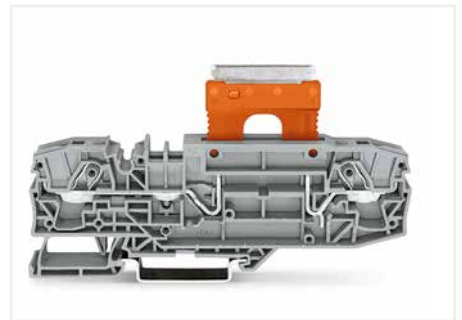

Carrier terminal block with disconnect plug (2006-8401) in parked position



Commoning a 15 mm-wide terminal block via push-in type jumper bars: 1 to 3 (2006-433) and 1 to 5 (2006-435).

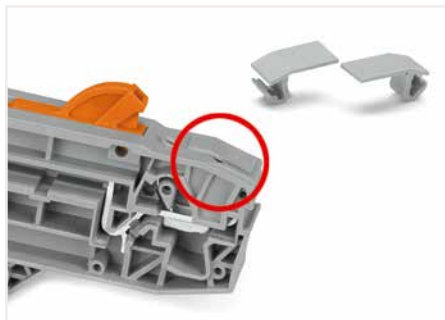

Cover (2006-191) seals unused conductor entry.

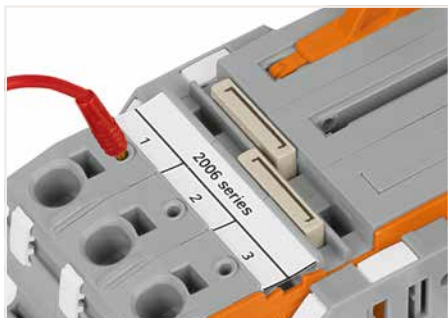

Test slots on both terminal block sides allow for direct measurement.



Test slots on both terminal block sides allow for direct measurement.



Alternatively, measurement can also be performed using Connectors (2006-511) from terminal block 1 to 2. Spacer modules (2006-549) must be used to compensate for the 15 mm terminal block width.

Current Transformer Terminal Blocks TOPJOB® S, 2007-8821 (Orange Disconnect Link)

1

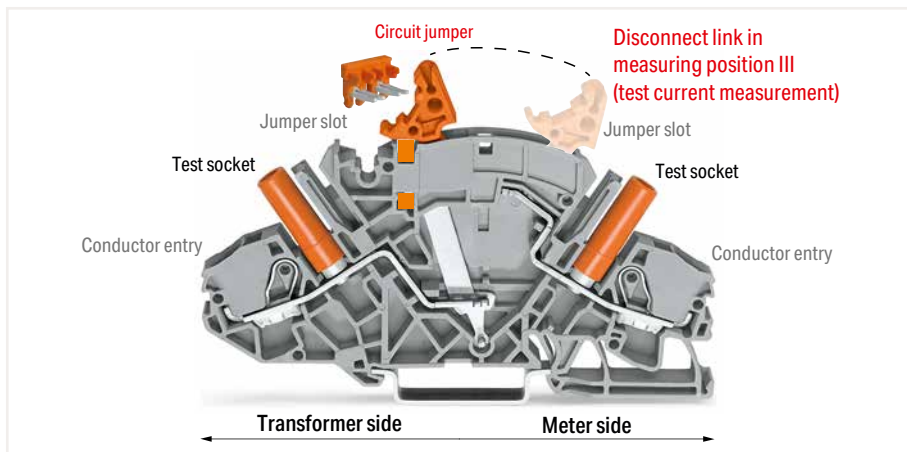
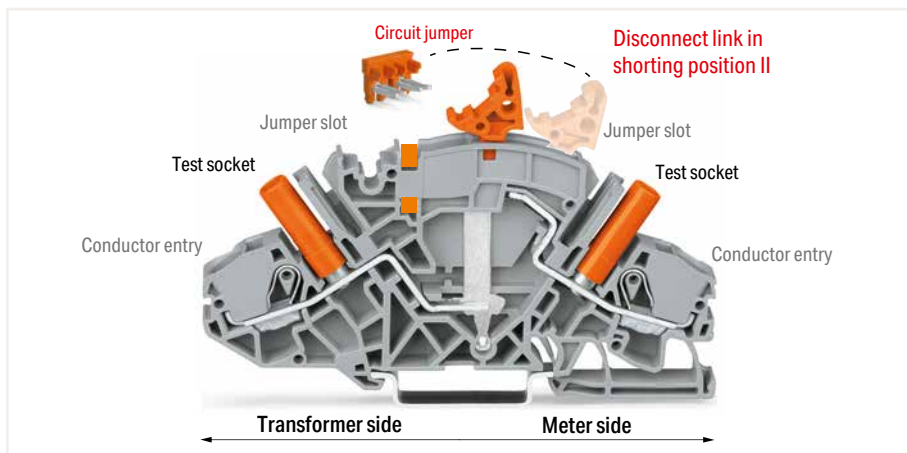
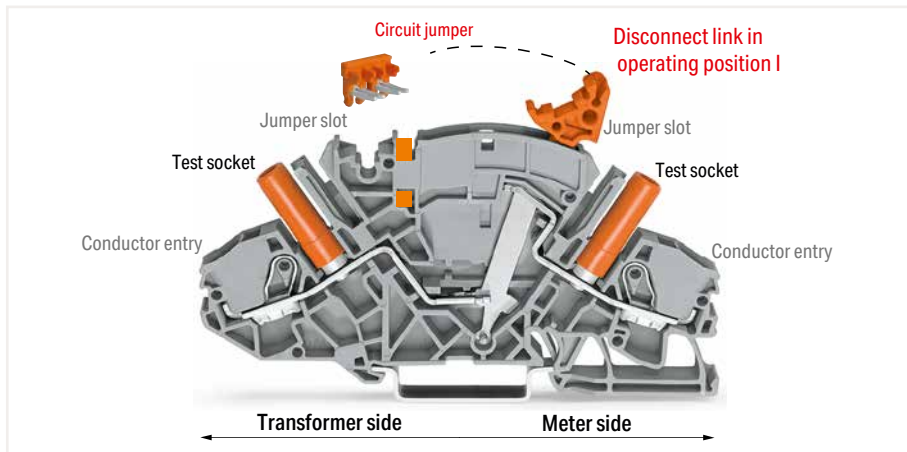

Current Transformer (Disconnect/Test) Terminal Block (2007-8821) is designed for current transformer circuits.

First, the current transformer is shorted via disconnect link and circuit jumper (insert jumper, move disconnect link from operating position I to shorting position II, activate shorting path). Connecting a measurement device via test socket on the meter side can only be performed once circuit disconnection is complete (disconnect link in measuring position III).

Advantages:

- Top-of-unit circuit jumper slot for shorting path activation
- Disconnect link provides intuitive and easy operation, as well as exact switching status indication.
- Combines high functionality with compact design (99.6 mm long and 8 mm wide).
- All 2007 Series terminal blocks are rated at 30 A/500 V (IEC) and 300 V (UL).
- With a terminal block width of 8 mm, the maximum cross-section for solid and fine-stranded conductors is 10 mm² (8 AWG) and 6 mm² (10 AWG) for ferruled conductors.
- Touch-proof test sockets for 4 mm Ø test plugs on transformer and meter side.
- Compatible with through and ground conductor terminal blocks having the same profile.



Preparing shorting path for the current transformer circuits.



Insert insulated, touch-proof circuit jumpers into jumper slot.



Using locking covers or profiles for adjacent terminal blocks allows disconnect links to be operated simultaneously.

Implementing a Current and Voltage Transformer Circuit TOPJOB® S



Disconnect link in operating position I
 Terminal blocks required:
 2 x disconnect/test terminal block (2007-8821)
 1 x circuit jumper, orange (2007-8442)
 Locking covers or interlocking links (option)

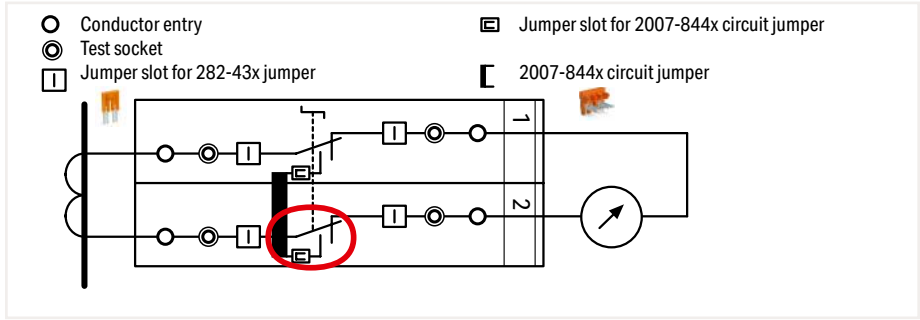

In the operating position, the measurement device is connected to the transformer, the circuit jumper is inserted and the disconnect link is in position I.



Disconnect link in shorting position II

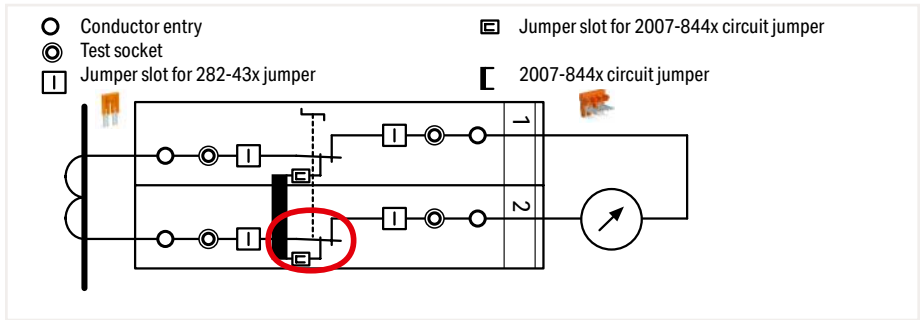

The transformer is not disconnected from the measuring device yet, the shorting path is activated by moving the disconnect link into shorting position II and the transformer is safely shorted.



Test current measurement: Disconnect link in measuring position III

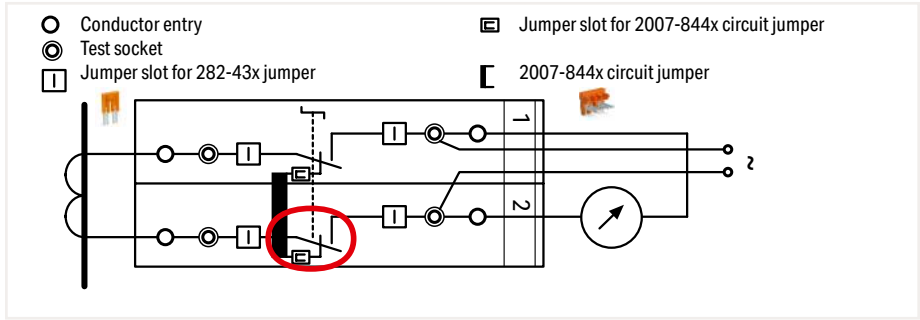

The measuring device is electrically disconnected from the transformer. If required, an external voltage can be applied to the measuring device via the test socket.



Measurement testing (using both test sockets)
 Terminal block 1: Disconnect link in operating position I
 Terminal block 2: Disconnect link in measuring position III

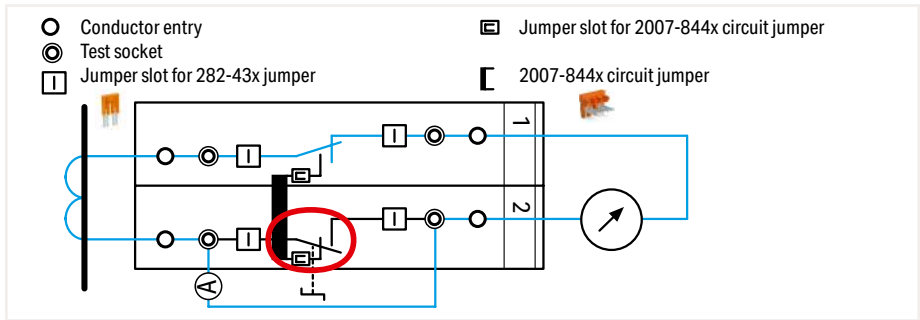

Measurement testing: First insert the reference current meter (A) into the test socket, then move the disconnect link into measurement point III (test current measurement).

Examples for Current Transformer Circuits TOPJOB® S

1



Measuring set for a three-phase current transformer
Terminal blocks required:

- 6 x disconnect/test terminal block (2007-8821)
- 3 x circuit jumper, orange (2007-8442)
- In addition: interlocking link, locking cover, lock-out

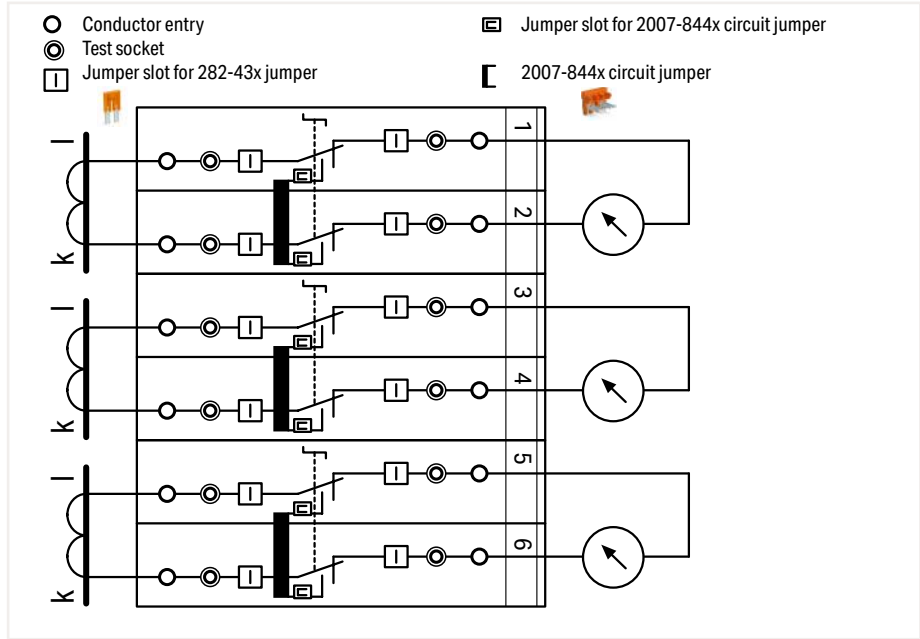

Pairs of disconnect links are interconnected via locking cover or interlocking link. Measurement testing is performed after the interlocking is released.



Measuring set for a three-phase current transformer
with 'Y' point

- Terminal blocks required:
- 6 x disconnect/test terminal block (2007-8821)
 - 1 x circuit jumper, orange (2007-8446)
 - 1 x jumper, orange (282-433)
 - In addition: interlocking link, locking cover, lock-out

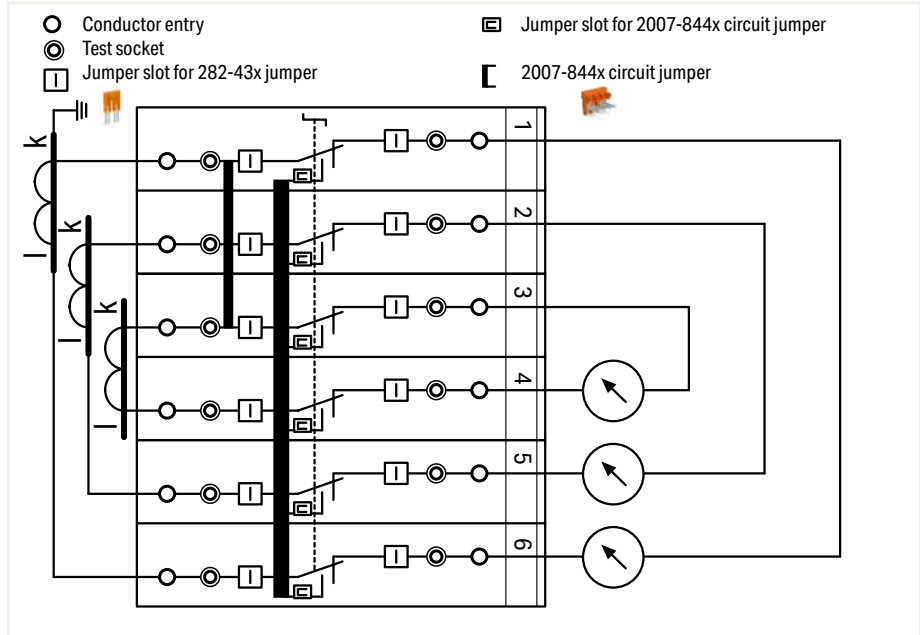

All six disconnect links are interconnected via locking cover or interlocking link.

Voltage Transformer Terminal Blocks TOPJOB® S, 2007-8811 (Light Gray Disconnect Link)

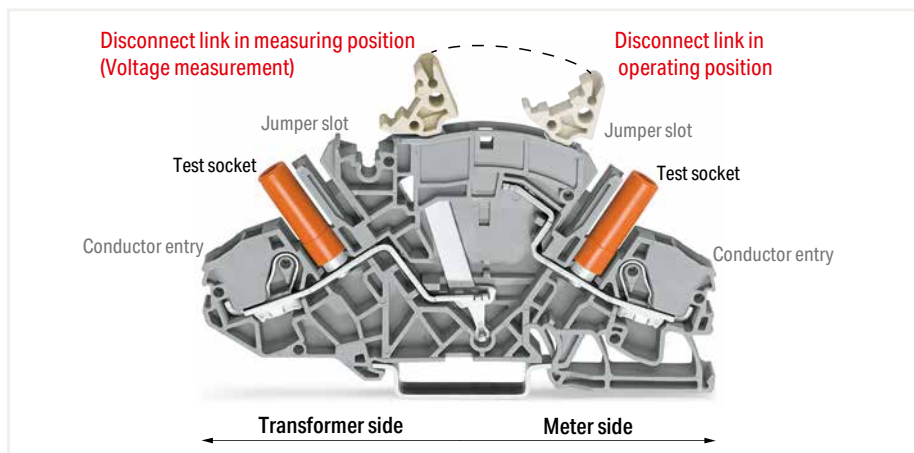

Voltage Transformer (Disconnect/Test) Terminal Block (2007-8811) is designed for current transformer circuits.

First, disconnect the voltage transformer from the circuit (move disconnect link from operating position to measurement position). Connecting a measurement device via test socket on the meter side can only be performed after disconnection is complete (measuring position).

Advantages:

- For voltage transformer circuits (no circuit jumper slot required as for 2007-8821 Current Transformer Terminal Block)
- Disconnect link provides intuitive and easy operation, as well as exact switching status indication.
- Combines high functionality with compact design (99.6 mm long and 8 mm wide).
- All 2007 Series terminal blocks are rated at 30 A/500 V (IEC) and 300 V (UL).
- With a terminal block width of 8 mm, the maximum cross-section for solid and fine-stranded conductors is 10 mm² (8 AWG) and 6 mm² (10 AWG) for ferruled conductors.
- Touch-proof test sockets for 4 mm Ø test plugs on transformer and meter side.
- Compatible with through and ground conductor terminal blocks having the same profile.



Example for voltage transformer testing:
Measuring set for single-phase voltage transformer testing

Terminal blocks required:

- 1 x disconnect/test terminal block (2007-8811)
- 1 x through terminal block (2007-8801)
- 1 x end plate, orange (2007-8892)
- In addition: locking cover, lock-out

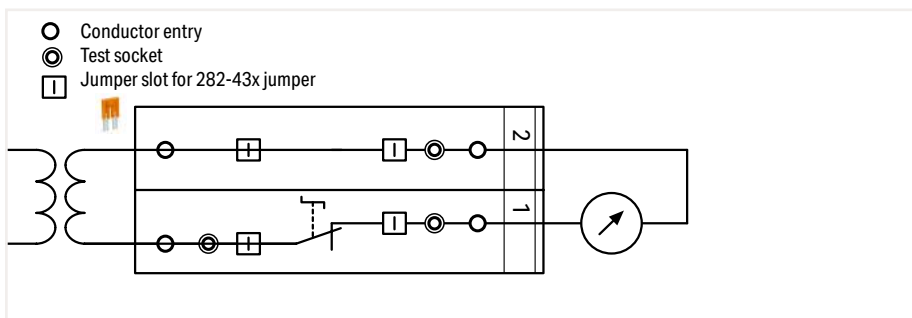

Disconnecting the voltage transformer from the circuit: Move disconnect link from operating position to measurement position.

Voltage measurement: Connecting a measurement device via test socket on the meter side can only be performed after disconnection is complete (measuring point).



Marking via WMB Multi markers or marking strips.



Additional commoning option on the transformer side



Multipole switching via snap-on type, transparent (locking) cover for disconnect links.

Disconnect/Test Terminal Block, Through Terminal Block, Ground Conductor Terminal Block TOPJOB® S; for Current and Voltage Transformer Circuits 6 mm²; 2007 Series

1

Technical Data	
0.5 ... 6 (10) mm ² ①	20 ... 8 AWG
500 V/6 kV/3 ②	300 V, 30 A ③
I _N 30 A	600 V, 30 A ④
Terminal block width: 8 mm / 0.315 inch	
13 ... 15 mm / 0.51 ... 0.59 inch	

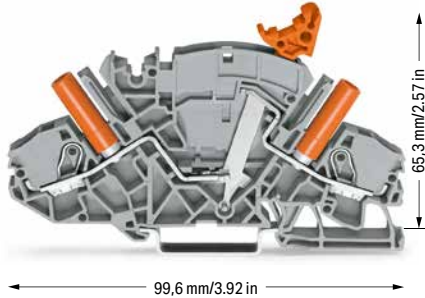

2-conductor disconnect/test terminal block; e.g., current transformer circuits; with circuit jumper slot; with touch-proof test sockets; for 4 mm Ø test plugs

Color	Item No.	Pack. Unit
○ gray	2007-8821	20

Technical Data	
0.5 ... 6 (10) mm ² ①	20 ... 8 AWG
500 V/6 kV/3 ②	300 V, 30 A ③
I _N 30 A	600 V, 30 A ④
Terminal block width: 8 mm / 0.315 inch	
13 ... 15 mm / 0.51 ... 0.59 inch	

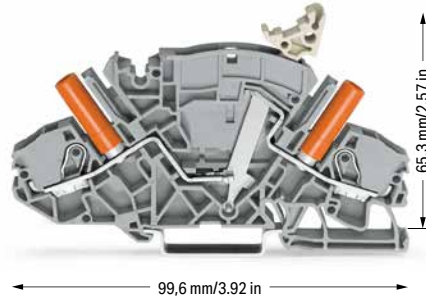

Disconnect/test terminal block; e.g., for voltage transformer circuits; with touch-proof test sockets; for 4 mm Ø test plugs

Color	Item No.	Pack. Unit
○ gray	2007-8811	20

Technical Data	
0.5 ... 6 (10) mm ² ①	20 ... 8 AWG
500 V/6 kV/3 ②	300 V, 30 A ③
I _N 30 A	600 V, 30 A ④
Terminal block width: 8 mm / 0.315 inch	
13 ... 15 mm / 0.51 ... 0.59 inch	

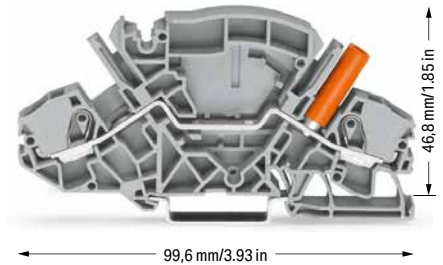

2-conductor through terminal block; with touch-proof test socket; for 4 mm Ø test plugs

Color	Item No.	Pack. Unit
○ gray	2007-8801	20
● blue	2007-8804	20

Accessories; item-specific

Ajacent jumper for switching lever; insulated; I_N 30 A; orange



2-way	2007-8442	50 (10)
3-way	2007-8443	50 (10)
4-way	2007-8444	50 (10)
5-way	2007-8445	50 (10)
6-way	2007-8446	50 (10)
7-way	2007-8447	50 (10)
8-way	2007-8448	50 (10)

Accessories; 2007 Series

End and separator plate; 1.5 mm thick; without lock-out seal option



orange	2007-8892	50 (10)
gray	2007-8891	50 (10)

End and separator plate; 1.5 mm thick; with lock-out seal option



orange	2007-8894	50 (10)
gray	2007-8893	50 (10)

Lock-out device; for disconnect link



yellow	2007-8899	100 (20)
--------	-----------	----------

Interlocking link; mechanically locks multiple links; 1 m long



transparent	210-254	1
-------------	---------	---

Locking cover; mechanically locks multiple links; transparent



1-pole	282-881	50 (10)
2-pole	282-882	50 (10)
3-pole	282-883	50 (10)
4-pole	282-884	50 (10)
5-pole	282-885	50 (10)
6-pole	282-886	50 (10)
7-pole	282-887	50 (10)
8-pole	282-888	50 (10)

Appropriate marking systems: WMB/Marking strips

Jumper; insulated; I_N 30 A; orange



2-way	282-432	50 (10)
3-way	282-433	50 (10)
4-way	282-434	50 (10)
5-way	282-435	50 (10)
6-way	282-436	50 (10)
7-way	282-437	50 (10)
8-way	282-438	50 (10)
9-way	282-439	50 (10)
10-way	282-440	50 (10)

Jumper with safety lid; insulated; I_N 30 A; orange



2-way	282-432/100-000	50 (10)
3-way	282-433/100-000	50 (10)
4-way	282-434/100-000	50 (10)

Jumper; insulated; I_N 30 A; orange



1-3	282-433/011-000	50 (10)
1-3-5	282-435/011-000	50 (10)
1-4-5	282-435/301-000	50 (10)
1-3-4-5	282-435/300-000	50 (10)
1-2-4-6	282-436/301-000	50 (10)
1-4-6	282-436/304-000	50 (10)
1-3-5-7	282-437/011-000	50 (10)
1-4-7	282-437/012-000	50 (10)
1-2-5-8	282-438/300-000	50 (10)
1-4-7-8	282-438/301-000	50 (10)
1-3-5-7-9	282-439/011-000	50 (10)

Protective warning marker; with black high-voltage symbol; for 5 terminal blocks



yellow	2006-115	100 (25)
--------	----------	----------

Marking strip; plain; 11 mm wide; 50 m reel



white	2009-110	1
-------	----------	---

WMB marking card; white; 10 strips with 10 markers/card; stretchable 5 ... 5.2 mm



plain	793-5501	5
-------	----------	---

WMB marking card; 10 strips with 10 markers/card; stretchable 5 ... 5.2 mm; yellow



k/l (50x)	794-5553/000-002	5
-----------	------------------	---

WMB marking card; 10 strips with 10 markers/card; stretchable 5 ... 5.2 mm; blue



U/V (50x)	794-5554/000-006	5
-----------	------------------	---

PUSH-IN CAGE CLAMP®

1

Technical Data

0.5 ... 6 (10) mm² ① | 20 ... 8 AWG

Terminal block width: 8 mm / 0.315 inch

13 ... 15 mm / 0.51 ... 0.59 inch



46,8 mm / 1.85 in

99,6 mm / 3.93 in

2-conductor ground terminal block; with touch-proof test socket; for 4 mm Ø test plugs

Color	Item No.	Pack. Unit
● green-yellow	2007-8807	20

① Conductor range: 0.5 ... 10 mm² "s+f-st"; Push-in termination: 2.5 ... 10 mm² "s" and 2.5 ... 6 mm² "insulated ferrules; 12 mm" Depending on the conductor characteristic, a conductor with a smaller cross section can also be inserted via push-in termination.

② 500 V = rated voltage
6 kV = rated impulse voltage
3 = pollution degree (see Section 15)

Please observe the application notes: Marking, from page 640

Approvals and corresponding ratings, visit www.wago.com



Marking via WMB Multi markers or marking strips.



Lock-out prevents accidental operation of disconnect link.



Lock-out snaps into one of two notched positions.



Interlocking link mechanically locks multiple links for multi-pole switching applications.



A lock-out seal can be used on the disconnect link in operating position I in combination with an end and separator plate (2007-8893 or 2007-8894).

Terminal Block Assembly TOPJOB® S; for Current and Voltage Transformers

6 (10) mm²; 2007 Series

1

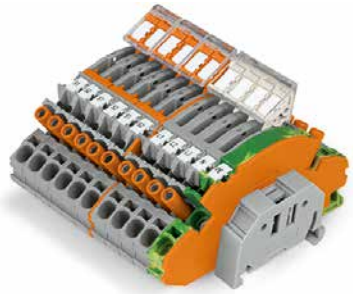

Item No. for 2007-8873	Quantity
Designation	
249-117	2
Screwless end stop; 10 mm wide	
282-882	3
Locking cover; mechanically locks multiple links, 2-pole	
282-884	1
Locking cover; mechanically locks multiple links, 4-pole	
2007-8442	3
Circuit jumper; insulated; 2-way	
2007-8807	1
2-conductor ground terminal block; with touch-proof test socket; for 4 mm Ø test plugs	
2007-8811	4
2-conductor disconnect/test terminal block; with touch-proof test sockets; for 4 mm Ø test plugs	
2007-8821	6
2-conductor disconnect/test terminal block; with touch-proof test sockets; for 4 mm Ø test plugs	
2007-8892	2
End and separator plate; 1.5 mm thick; without lock-out seal option	
2009-115	21
WMB Inline, plain; 1,500 WMB markers (5 mm)/reel; 5 ... 5.2 mm stretchable	markers
282-435/011-000	1
Jumper; insulated; 1-3-5	
Assembly width incl. end stop: 11.2 cm	

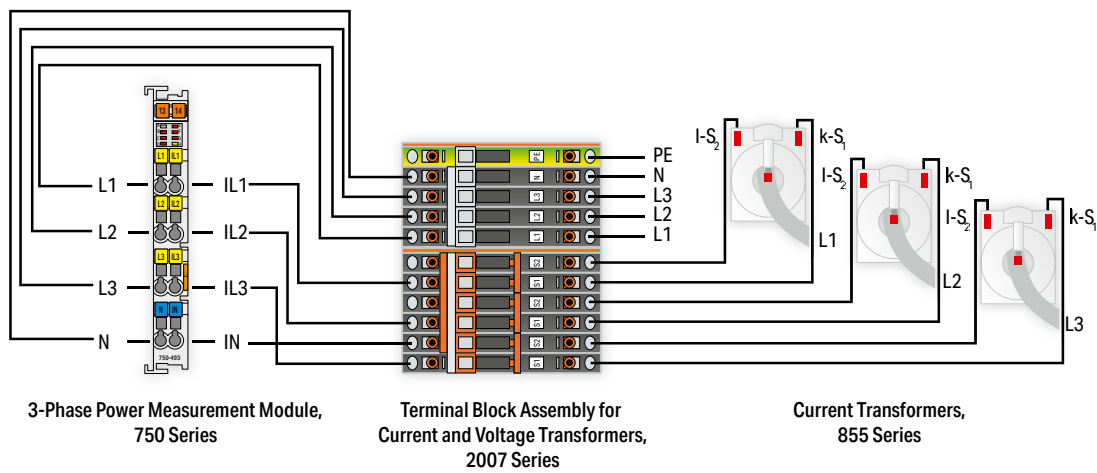



Item No. for 2007-8876	Quantity
Designation	
249-117	2
Screwless end stop; 10 mm wide	
282-369	1
Collective jumper carrier; for DIN-35 rail; compatible with jumpers for transverse switching terminal block (282-811) and longitudinal switching disconnect terminal block (282-821)	
282-882	3
Locking cover; mechanically locks multiple links, 2-pole	
2007-8442	3
Circuit jumper; insulated; 2-way	
2007-8821	6
2-conductor disconnect/test terminal block; with touch-proof test sockets; for 4 mm Ø test plugs	
2007-8892	1
End and separator plate; 1.5 mm thick; without lock-out seal option	
2009-115	12
WMB Inline, plain; 1,500 WMB markers (5 mm)/reel; 5 ... 5.2 mm stretchable	markers
282-435/011-000	1
Jumper; insulated; 1-3-5	
Assembly width incl. end stop: 8.5 cm	

Fuse Plug TOPJOB® S on Carrier Terminal Block 2.5 (4) mm² 2004 Series

1

Technical Data

250 V / I_N 6.3 A
Plug width: 6.1 mm / 0.24 inch

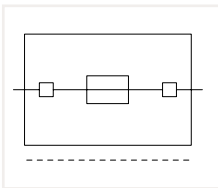

Fuse plug with pull-tab; for 5 x 20 mm glass cartridge fuses
Electrical ratings are given by the fuse.

Color	Item No.	Pack. Unit
○ gray	2004-911	50

Technical Data

250 V / I_N 6.3 A
Plug width: 6.1 mm / 0.24 inch

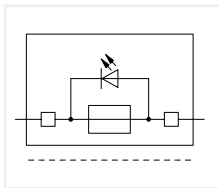

Fuse plug with pull-tab; for 5 x 20 mm glass cartridge fuses; with LED, gray
Electrical ratings are given by the fuse and blown fuse indication. Leakage current in case of a blown fuse: LED 2 mA

	Item No.	Pack. Unit
○ 12 ... 30 V	2004-911/1000-541	50
○ 30 ... 65 V	2004-911/1000-542	50
○ 120 V	2004-911/1000-867	50
○ 230 V	2004-911/1000-836	50

Approvals and corresponding ratings, visit www.wago.com

Accessories; for fuse plugs

Appropriate marking systems:
WMB/Marking strips

Double-deck carrier terminal block; 0.25 ... 2.5 (4) mm² / 22 ... 12 AWG
Terminal block width: 5.2 mm / 0.205 inch

L/L	2002-2961	50

Double-deck carrier terminal block; 0.25 ... 2.5 (4) mm² / 22 ... 12 AWG
Terminal block width: 5.2 mm / 0.205 inch

L/N	2002-2963	50

End and intermediate plate; 1 mm thick

	orange	2002-2992	100 (25)
	gray	2002-2991	100 (25)

End plate for fuse terminal blocks; 2 mm thick

	orange	2002-992	100 (25)
	gray	2002-991	100 (25)

Shorting link; 5 x 20 mm; allows the fuse plug to be used as a disconnect plug

	I _N 6.3 A	281-503	250 (25)
--	----------------------	---------	----------

WMB marking card; white; 10 strips with 10 markers/card; 5 ... 5.2 mm stretchable

	plain	793-5501	5
--	-------	----------	---

Accessories; for fuse plugs

Appropriate marking systems: WMB/Marking strips

2-conductor carrier terminal block; 0.25 ... 2.5 (4) mm² / 22 ... 12 AWG
Terminal block width: 5.2 mm / 0.205 inch

	gray	2002-1661	50
--	------	-----------	----

4-conductor carrier terminal block; 0.25 ... 2.5 (4) mm² / 22 ... 12 AWG
Terminal block width: 5.2 mm / 0.205 inch

	gray	2002-1861	50
--	------	-----------	----

2-conductor carrier terminal block; with push-button 0.25 ... 2.5 (4) mm² / 22 ... 12 AWG
Terminal block width: 5.2 mm / 0.205 inch

	gray	2202-1661	50
--	------	-----------	----

4-conductor carrier terminal block; with push-button 0.25 ... 2.5 (4) mm² / 22 ... 12 AWG
Terminal block width: 5.2 mm / 0.205 inch

	gray	2202-1861	50
--	------	-----------	----

End and intermediate plate; 1 mm thick

	orange	2002-1692	100 (25)
	gray	2002-1691	100 (25)

End and intermediate plate; 1 mm thick

	orange	2002-1892	100 (25)
	gray	2002-1891	100 (25)

3-conductor carrier terminal block; 0.25 ... 2.5 (4) mm² / 22 ... 12 AWG
Terminal block width: 5.2 mm / 0.205 inch

	gray	2002-1761	50
--	------	-----------	----

2-conductor carrier terminal block; 0.25 ... 2.5 (4) mm² / 22 ... 12 AWG
Terminal block width: 5.2 mm / 0.205 inch

	gray	2002-1961	50
--	------	-----------	----

3-conductor carrier terminal block; with push-button 0.25 ... 2.5 (4) mm² / 22 ... 12 AWG
Terminal block width: 5.2 mm / 0.205 inch

	gray	2202-1761	50
--	------	-----------	----

2-conductor carrier terminal block; with push-button 0.25 ... 2.5 (4) mm² / 22 ... 12 AWG
Terminal block width: 5.2 mm / 0.205 inch

	gray	2202-1961	50
--	------	-----------	----

End and intermediate plate; 1 mm thick

	orange	2002-1792	100 (25)
	gray	2002-1791	100 (25)

End and intermediate plate; 1 mm thick

	orange	2002-1992	100 (25)
	gray	2002-1991	100 (25)

WMB marking card; white; 10 strips with 10 markers/card; 5 ... 5.2 mm stretchable

	F1, ..., F10 (10x)	794-5615	5
	F11, ..., F20 (10x)	794-5616	5
	F21, ..., F30 (10x)	794-5617	5
	F31, ..., F40 (10x)	794-5618	5
	F41, ..., F50 (10x)	794-5619	5

Fuse Plugs TOPJOB® S on Carrier Terminal Blocks 2.5 (4) mm²

Technical Information

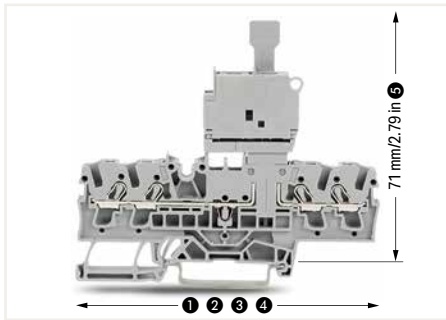

Fuse plug dimensions:

- ① 66.1 mm / 2.62 inch for 2002-1661
- ② 76.8 mm / 3.02 inch for 2002-1761
- ③ 87.5 mm / 3.45 inch for 2002-1861
- ④ 72.9 mm / 2.87 inch for 2002-1961
- ⑤ with inserted fuse plug



Using fuse plugs with rail-mount terminal blocks for control circuit protection is highly advantageous because the function and wiring levels are separated:

- No additional cost for assembly and wiring
- No risk of accidental contact with live parts when disconnecting the fuse plug
- The fuse plug is completely separated from the carrier terminal block when replacing a fuse – away from current carrying parts
- The fuse plug can be removed by service personnel
- No unintentional reclosing of the circuit by another person
- Quickly exchange a fuse by using a prepared "stand-by plug"

Fuse plug features for quick and safe applications:

- Optional LED indicates blown fuse
- Top-of-unit marking slot provides clear carrier terminal block identification
- Two test slots with touch contacts
- Terminal blocks/plugs provide high-density wiring in a width of just 5.2/6.1 mm
- May be used as a disconnect plug in combination with a shorting link

Glass cartridge fuses 5 x 20

Series Item No.	Overload and short circuit protection		Short circuit protection only	
	Individual argmt.	Group argmt.	Individual argmt.	Group argmt.
Fuse terminal blocks				
2004-911				
2004-911/.....	1.6 W	1.6 W	2.5 W	2.5 W

When selecting glass cartridge fuses, make sure that the maximum power loss listed below is not exceeded. The power loss is determined according to IEC or EN 60947-7-3/VDE 0611-6 at 23°C. The temperature rise of the terminal blocks must be checked according to their application and mounting. Higher ambient temperatures represent an additional impact on fuse cartridges. Therefore, in such applications, the rated current must be reduced if necessary. More details are available from the manufacturers.

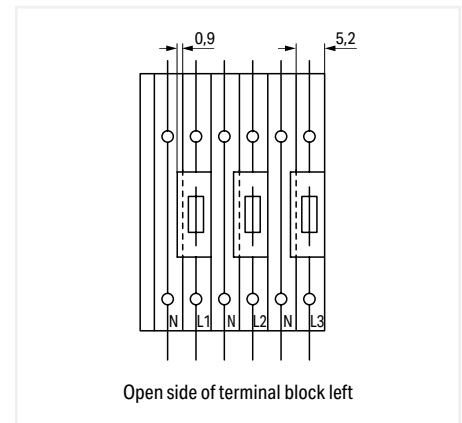

Please note:

The extra width of the plug (6.1 mm compared to 5.2 mm for carrier terminal blocks) must be compensated for with intermediate plates (1 mm) when building an assembly of carrier terminal blocks equipped with fuse plugs.

Fuse Plug TOPJOB® S on Carrier Terminal Block 6 (10) mm² 2006 Series

1

Technical Data		
800 V / I _N 10 A		
Plug width: 7.4 mm / 0.291 inch		

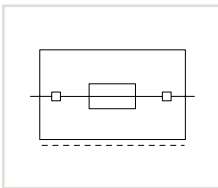

Fuse plug with pull-tab
Electrical ratings are given by the fuse.

for 5 x 20 mm glass cartridge fuse

Color	Item No.	Pack. Unit
○ gray	2006-911	25

Technical Data		
800 V / I _N 10 A		
Plug width: 7.4 mm / 0.291 inch		

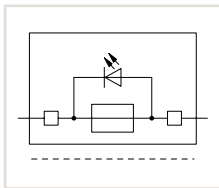

Fuse plug with pull-tab; with LED; gray
Electrical ratings are given by the fuse and blown fuse indication. Leakage current in case of a blown fuse: LED 2 mA

for 5 x 20 mm glass cartridge fuse

	Item No.	Pack. Unit
○ 12 ... 30 V	2006-911/1000-541	25
○ 30 ... 65 V	2006-911/1000-542	25
○ 230 V	2006-911/1000-836	25

Technical Data		
800 V / I _N 10 A		
Plug width: 10.4 mm / 0.409 inch		

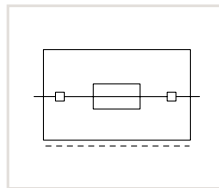

Fuse plug with pull-tab
Electrical ratings are given by the fuse.

for ¼" x 1¼" glass cartridge fuse

Color	Item No.	Pack. Unit
○ gray	2006-931/099-000	25

for 5 x 30 mm glass cartridge fuse		
○ gray	2006-921	25

for 5 x 30 mm glass cartridge fuse		
○ 12 ... 30 V	2006-921/1000-541	25
○ 30 ... 65 V	2006-921/1000-542	25
○ 230 V	2006-921/1000-836	25
○ 380 ... 500 V	2006-921/1000-859	25

for ¼" x 1¼" glass cartridge fuse		
○ gray	2006-931	25

for ¼" x 1¼" glass cartridge fuse		
○ 12 ... 30 V	2006-931/1000-541	25
○ 120 V	2006-931/1000-867	25
○ 230 V	2006-931/1000-836	25
○ 380 ... 500 V	2006-931/1000-859	25

Accessories; item-specific			
End and intermediate plate; 1 mm thick			
	orange	2006-1692	100 (25)
	gray	2006-1691	100 (25)

Accessories; item-specific			
End and intermediate plate; 1 mm thick			
	orange	2006-1692	100 (25)
	gray	2006-1691	100 (25)

Accessories; item-specific			
Intermediate plate; 2.9 mm thick			
	orange	2006-1696	100 (25)
	gray	2006-1695	100 (25)

Accessories; for fuse plugs

End plate for fuse terminal blocks; 2 mm thick			
	orange	2006-992	100 (25)
	gray	2006-991	100 (25)

2-conductor carrier terminal block; 0.5 ... 6 (10) mm ² / 20 ... 8 AWG			
Terminal block width: 7.5 mm / 0.295 inch			
	gray	2006-1661	25
	blue	2006-1664	25

Appropriate marking systems: WMB/Marking strips

Shorting link; 5 x 20 mm; allows the fuse plug to be used as a disconnect plug			
	I _N 6.3 A	281-503	250 (25)

WMB marking card; white; 10 strips with 10 markers/card; 5 ... 5.2 mm stretchable			
	plain	793-5501	5

WMB marking card; white; 10 strips with 10 markers/card; 5 ... 5.2 mm stretchable			
	F1, ..., F10 (10x)	794-5615	5
	F11, ..., F20 (10x)	794-5616	5
	F21, ..., F30 (10x)	794-5617	5
	F31, ..., F40 (10x)	794-5618	5
	F41, ..., F50 (10x)	794-5619	5

Technical Data

800 V / I_n 10 A

Plug width: 10.4 mm / 0.409 inch

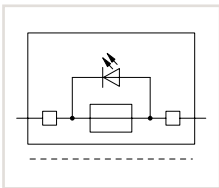

Fuse plug with pull-tab; with LED; gray
Electrical ratings are given by the fuse and blown fuse indication. Leakage current in case of a blown fuse: LED 2 mA

for ¼" x 1¼" glass cartridge fuse

	Item No.	Pack. Unit
○ 12 ... 30 V	2006-931/1099-541	25
○ 30 ... 65 V	2006-931/1099-542	25
○ 230 V	2006-931/1099-836	25
○ 380 ... 500 V	2006-931/1099-859	25

Approvals and corresponding ratings, visit www.wago.com

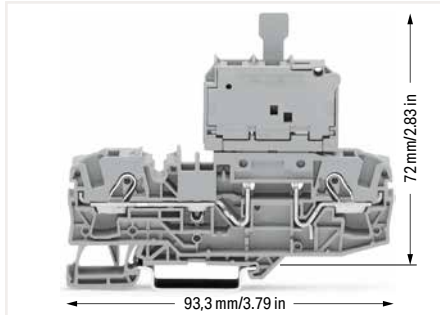

Using fuse plugs with rail-mount terminal blocks for control circuit protection is highly advantageous because the function and wiring levels are separated:

- No additional cost for assembly and wiring
- No risk of accidental contact with live parts when disconnecting the fuse plug
- The fuse plug is completely separated from the carrier terminal block when replacing a fuse – away from current carrying parts
- The fuse plug can be removed by service personnel
- No unintentional reclosing of the circuit by another person
- Quickly exchange a fuse by using a prepared "stand-by plug"

Fuse plug features for quick and safe applications:

- Optional LED indicates blown fuse
- Top-of-unit marking slot provides clear carrier terminal block identification
- Two test slots with touch contacts
- Terminal blocks/plugs provide high-density wiring in a width of just 7.5/7.4 (10.4) mm
- May be used as a disconnect plug in combination with a shorting link

Glass cartridge fuses

Series Item No.	Overload and short circuit protection		Short circuit protection only	
	Individual argmt.	Group argmt.	Individual argmt.	Group argmt.
Fused disconnect terminal blocks				
2006-911	7.5	1.6 W	1.6 W	2.5 W
2006-921	7.5	1.6 W	1.6 W	2.5 W
2006-931	7.5	1.6 W	1.6 W	2.5 W
2006-931 /099...	10.4	2.5 W	2.5 W	2.5 W
2006-931 /1099...	10.4	2.5 W	2.5 W	2.5 W

When selecting glass cartridge fuses, make sure that the maximum power loss listed below is not exceeded. The power loss is determined according to IEC or EN 60947-7-3/VDE 0611-6 at 23°C. The temperature rise of the terminal blocks must be checked according to their application and mounting. Higher ambient temperatures represent an additional impact on fuse cartridges. Therefore, in such applications, the rated current must be reduced if necessary. More details are available from the manufacturers.

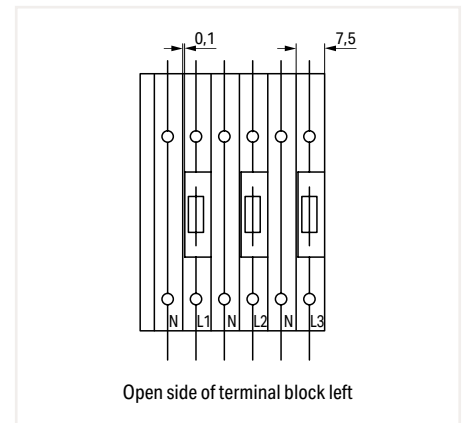

Open side of terminal block left

When using 10.4 mm wide plugs, please note: The extra width of the plug (10.4 mm compared to 7.5 mm for carrier terminal blocks) must be compensated for with intermediate plates (2.9 mm) when building an assembly of carrier terminal blocks equipped with fuse plugs.

Accessories; item-specific

Intermediate plate; 2.9 mm thick

	orange	2006-1696	100 (25)
	gray	2006-1695	100 (25)

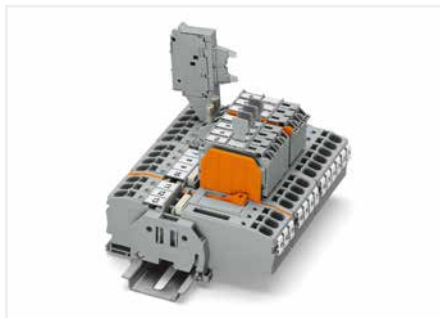

Pivoting fuse holder with spare fuse holder

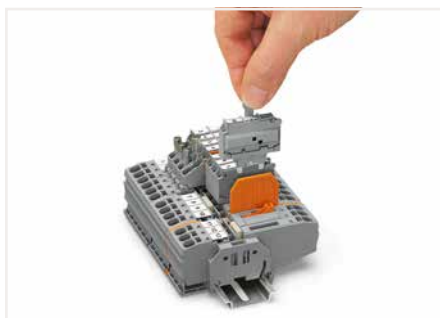

The end plate ensures that the fuse can only be removed when the fuse plug is pulled out.

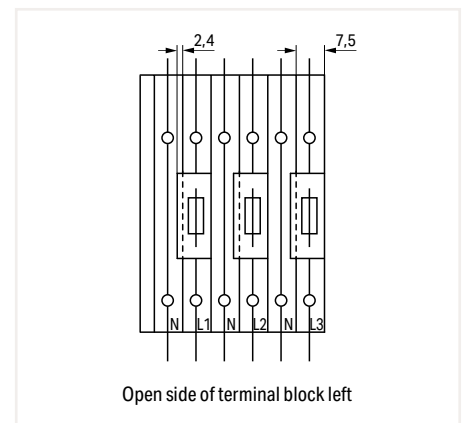

Open side of terminal block left

When using 10.4 mm wide plugs, please note: The extra width of the plug (10.4 mm compared to 7.5 mm for carrier terminal blocks) must be compensated for with intermediate plates (2.9 mm) when building an assembly of carrier terminal blocks equipped with fuse plugs.

Sensor Terminal Blocks and Actuator Terminal Blocks TOPJOB® S

2000 Series

Description and Installation

1



Commoning (signal level):

Commoning the signal level with push-in type jumper bars (2000 Series). Models with an LED can only be commoned in one jumper slot.

Test Plug Adapters can be used in all jumper slots.

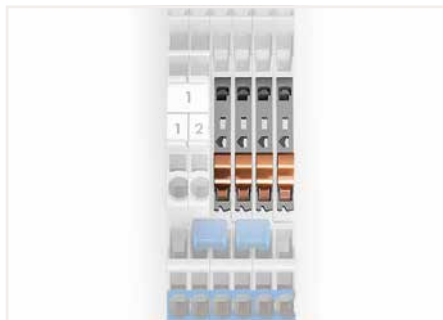

Upper level: two independent signal pathways



Commoning (potential level):

Commoning potential levels via push-in type jumper bars (2000 Series).



Power supply:

Orange supply terminal block of same profile from both the cabinet and sensor sides



Marking:

Marking strips (2009-110) – from the top or the side

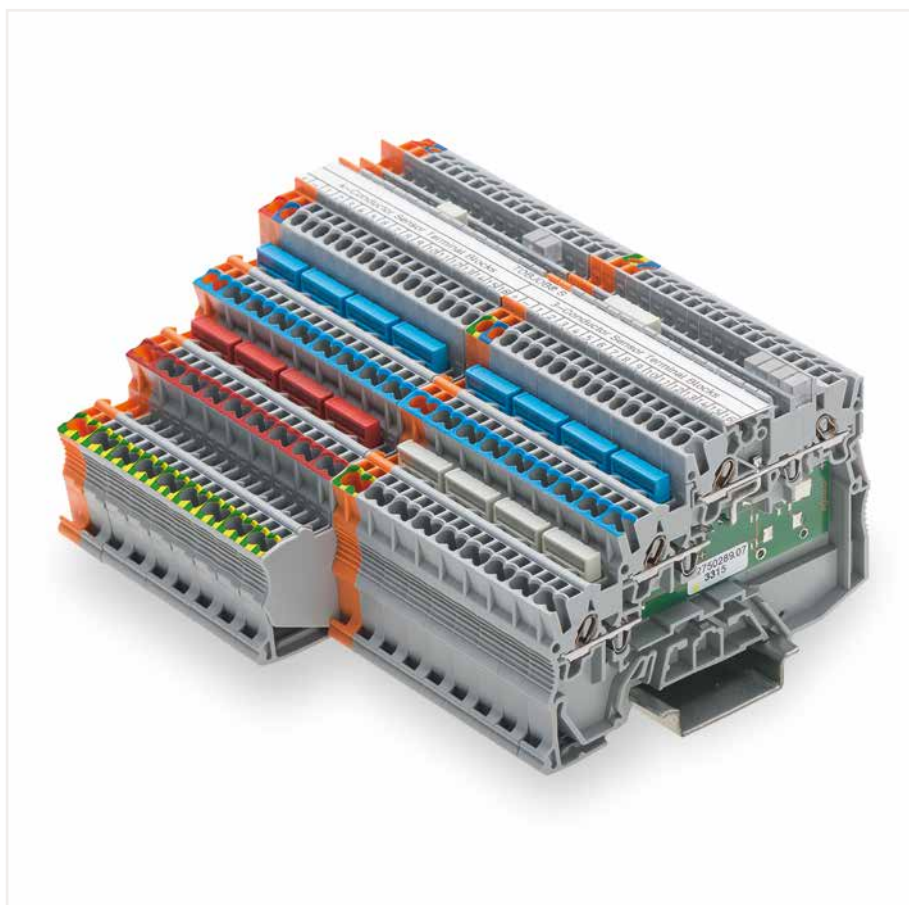

Terminal block assembly with 4-conductor sensor terminal blocks and 3-conductor actuator terminal blocks

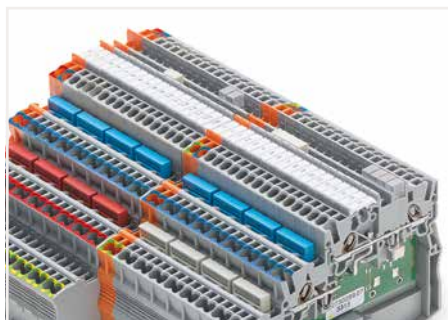

Marking:

3.5 mm WMB markers (793-35xx) from the top or the side – additional marking option via marker carrier

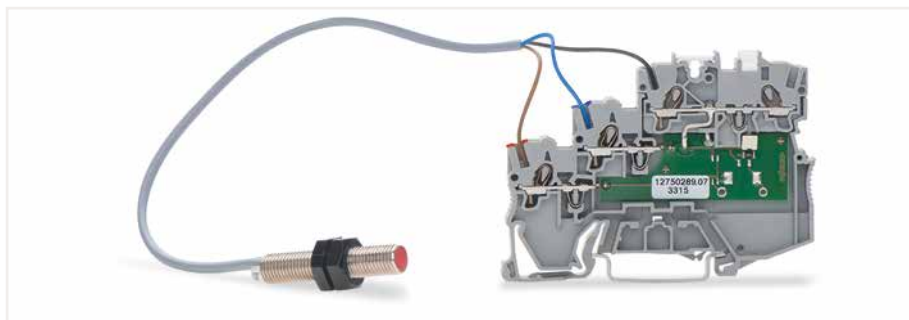

3-conductor sensor LED terminal block with a connected sensor



Commoning (potential level):
Continuous commoning in the potential levels via push-in type jumper bars for even pole numbers (2000 Series)



Potential levels: two adjacent commoning options on a current bar

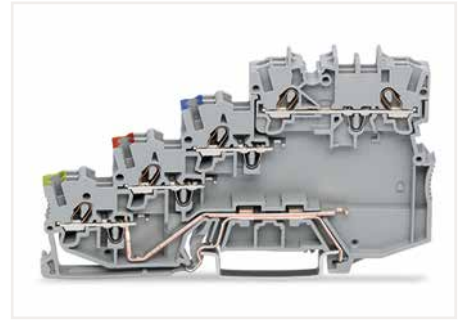

4-conductor sensor terminal block with ground contact

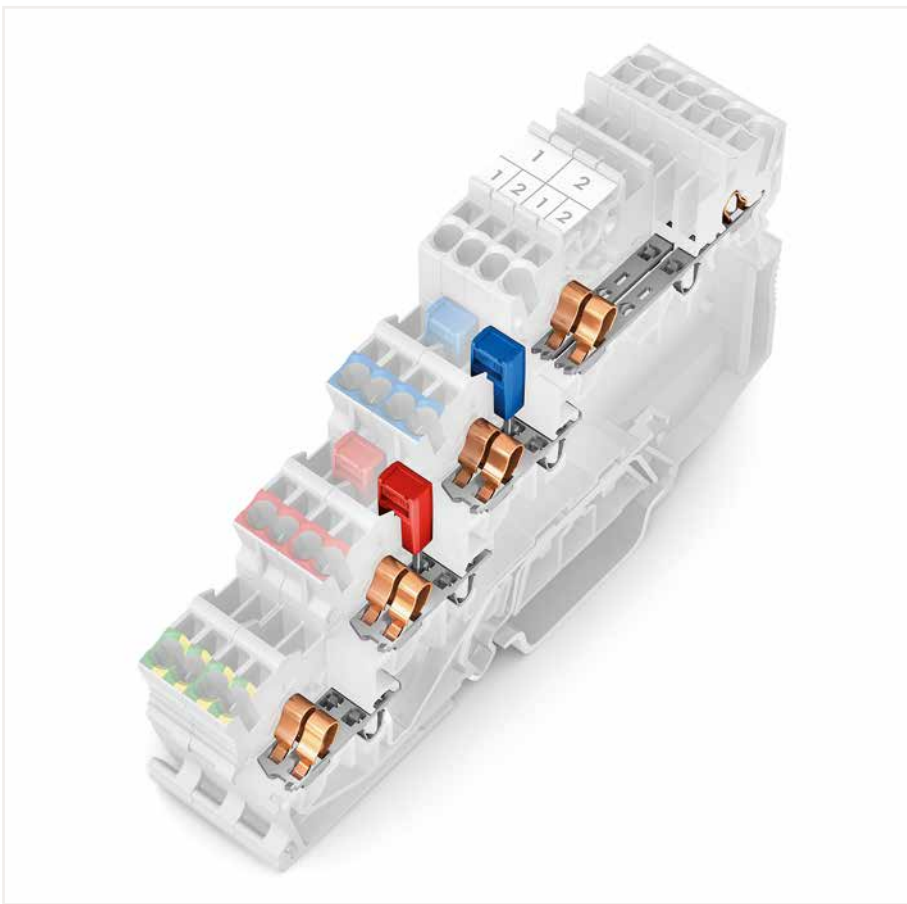

Upper level: two independent signal pathways, in 3.5 mm spacing per pole, with a dual jumper slot
Lower levels: two interconnected potential clamping units, with a single jumper slot, can be commoned in both directions



Ground commoning:
For sensor and actuator terminal blocks without ground connection to the DIN-rail, the ground connection can be performed by commoning to the terminal block with a ground foot.

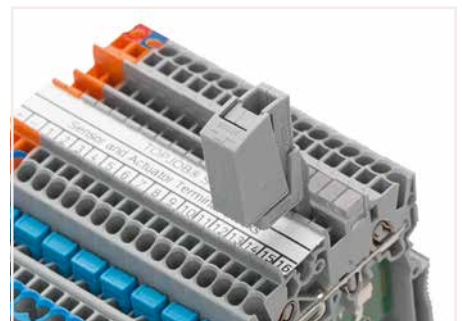

Testing via testing tap (2009-182) (up to max. 42 V).

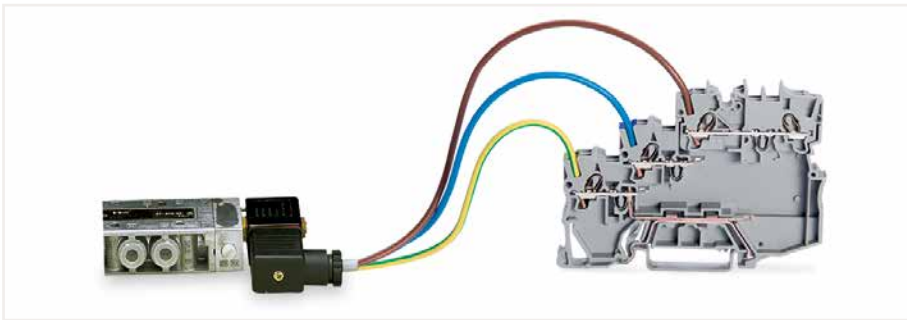

3-conductor actuator LED terminal block with a connected actuator

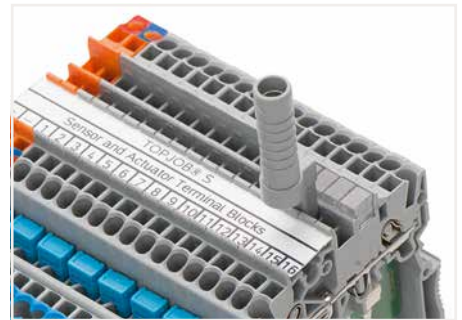

Testing via test plug adapter (2009-174) (up to max. 42 V).

3-Conductor Sensor Terminal Block TOPJOB® S

1 (1.5) mm²; 2000 Series

1

Technical Data	
0.14 ... 1 (1.5) mm ² ①	24 ... 16 AWG
250 V/4 kV/3 ②	300 V, 15 A ③
I _N 13.5 A	300 V, 10 A ④
Terminal block width: 7 mm / 0.276 inch ⑤	
9 ... 11 mm / 0.35 ... 0.43 inch	

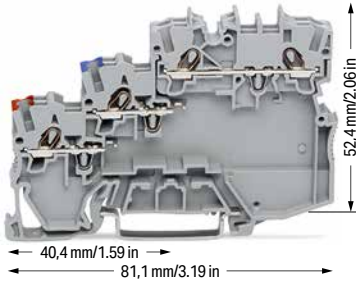

2000-5311

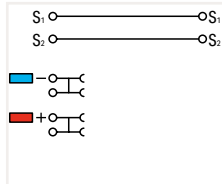

3-conductor sensor terminal block

Color	Item No.	Pack. Unit
gray	2000-5311	50

Technical Data	
0.14 ... 1 (1.5) mm ² ①	24 ... 16 AWG
24 VDC	24 V, 15 A ③
I _N 13.5 A	24 V, 10 A ④
Terminal block width: 7 mm / 0.276 inch ⑤	
9 ... 11 mm / 0.35 ... 0.43 inch	

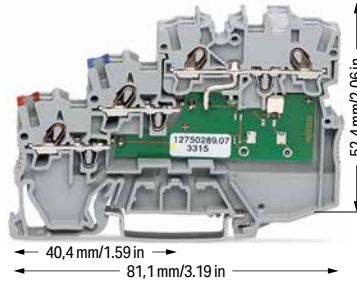

2000-5311/1102-950

2000-5311/1101-951

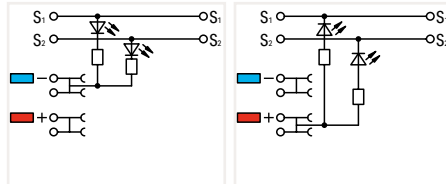

3-conductor sensor terminal block; yellow LED; for PNP (high-side) switching sensors

Color	Item No.	Pack. Unit
gray	2000-5311/1102-950	50

3-conductor sensor terminal block; yellow LED; for NPN (low-side) switching sensors

gray	2000-5311/1101-951	50
------	--------------------	----

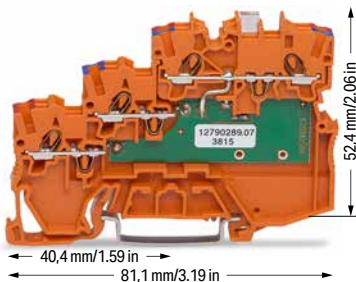

2000-5372/1102-953

2000-5372

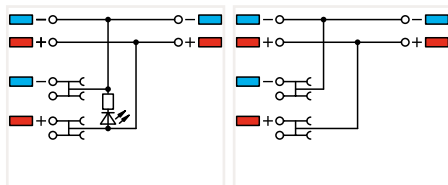

3-conductor sensor LED supply terminal block; green LED; 24 VDC

Color	Item No.	Pack. Unit
orange	2000-5372/1102-953	15

3-conductor sensor supply terminal block; max. 250 V; internally commoned

orange	2000-5372	15
--------	-----------	----

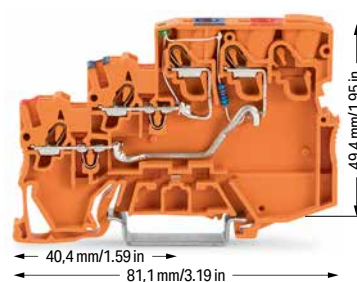

2000-5352/1102-953

2000-5352

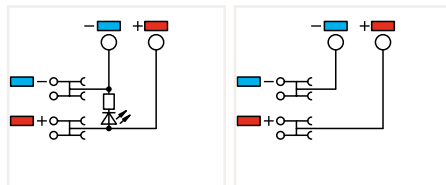

3-conductor sensor LED supply terminal block; green LED; 24 VDC control panel side: 2.5 (4) mm²; max. 28 A

Color	Item No.	Pack. Unit
orange	2000-5352/1102-953	50

3-conductor sensor supply terminal block; max. 250 V; control panel side: 2.5 (4) mm²; max. 28 A

orange	2000-5352	50
--------	-----------	----

① Conductor range: 0.14 ... 1.5 mm² "s+f-st"; Push-in termination: 0.5 ... 1.5 mm² "s" and 0.5 ... 0.75 mm² "insulated ferrules; 10 mm" Depending on the conductor characteristic, a conductor with a smaller cross section can also be inserted via push-in termination.

② 250 V = rated voltage
4 kV = rated impulse voltage
3 = pollution degree (see Section 15)

③ 3.5 mm spacing per signal (2 x 3.5 mm = 7 mm)
Note:
The double spacing per pole of this terminal block series maximizes connectivity. For example, ten sensors may be connected using only five sensor terminal blocks plus a power supply terminal block.

Please observe the application notes: Jumpers, from page 174

Approvals and corresponding ratings, visit www.wago.com

Accessories; for 3-conductor terminal blocks

Appropriate marking systems:
WMB/WMB Inline/Marking strips

End and intermediate plate; 1 mm thick; for 3-conductor terminal blocks

gray	2000-5391	100 (25)
------	-----------	----------

Push-in type jumper bar; insulated; I_N 14 A; light gray

2-way	2000-402	25
3-way	2000-403	25
4-way	2000-404	25
5-way	2000-405	25
6-way	2000-406	25
7-way	2000-407	25
8-way	2000-408	25
9-way	2000-409	25
10-way	2000-410	25

Colored push-in type jumper bar

- red .../000-005
- blue .../000-006

Push-in type jumper bar; insulated; I_N 14 A; light gray

1 to 3	2000-433	25
1 to 4	2000-434	25
1 to 5	2000-435	25
1 to 6	2000-436	25
1 to 7	2000-437	25
1 to 8	2000-438	25
1 to 9	2000-439	25
1 to 10	2000-440	25

Double-deck marker carrier; pivoting

gray	2000-121	50 (25)
------	----------	---------

Marking strip; plain; 11 mm wide; 50 m reel

white	2009-110	1
-------	----------	---

WMB marking card; white; 10 strips with 10 markers/card; for 3.5 mm terminal block width

plain	793-3501	5
-------	----------	---

Operating tool with a partially insulated shaft; type 1; (2.5 x 0.4) mm blade

	210-719	1
--	---------	---

4-Conductor Sensor Terminal Block TOPJOB® S

1 (1.5) mm²; 2000 Series

Technical Data	
0.14 ... 1 (1.5) mm ² ①	24 ... 16 AWG
250 V/4 kV/3 ②	300 V, 15 A ③
I _N 13.5 A	300 V, 10 A ④
Terminal block width: 7 mm / 0.276 inch ⑤	
9 ... 11 mm / 0.35 ... 0.43 inch	

Technical Data	
0.14 ... 1 (1.5) mm ² ①	24 ... 16 AWG
24 VDC	24 V, 15 A ③
I _N 13.5 A	24 V, 10 A ④
Terminal block width: 7 mm / 0.276 inch ⑤	
9 ... 11 mm / 0.35 ... 0.43 inch	

① Conductor range: 0.14 ... 1.5 mm² "s-f-st"; Push-in termination: 0.5 ... 1.5 mm² "s" and 0.5 ... 0.75 mm² "insulated ferrules; 10 mm" Depending on the conductor characteristic, a conductor with a smaller cross section can also be inserted via push-in termination.

② 250 V = rated voltage
4 kV = rated impulse voltage
3 = pollution degree (see Section 15)

③ 3.5 mm spacing per signal (2 x 3.5 mm = 7 mm)
Note:
The double spacing per pole of this terminal block series maximizes connectivity. For example, ten sensors may be connected using only five sensor terminal blocks plus a power supply terminal block.

Please observe the application notes: Jumpers, from page 174

Approvals and corresponding ratings, visit www.wago.com

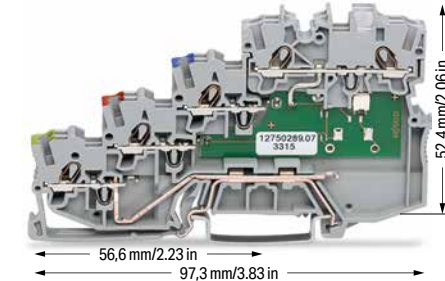
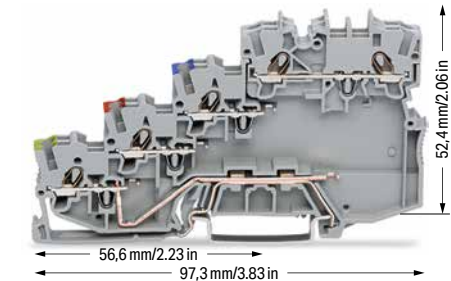

2000-5417

2000-5417/1102-950

2000-5417/1101-951

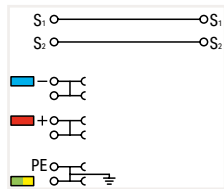

4-conductor sensor terminal block; with ground connection

Color	Item No.	Pack. Unit
gray	2000-5417	50

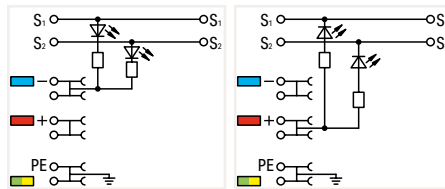

4-conductor sensor LED terminal block; yellow LED; for PNP (high-side) switching sensors; with ground connection

Color	Item No.	Pack. Unit
gray	2000-5417/1102-950	50

4-conductor sensor terminal block; yellow LED; for NPN (low-side) switching sensors; with ground connection

gray	2000-5417/1101-951	50
------	--------------------	----

Accessories; for 4-conductor terminal blocks

Appropriate marking systems:
WMB/WMB Inline/Marking strips

End and intermediate plate; 1 mm thick; for 4-conductor terminal blocks

gray	2000-5491	100 (25)
------	-----------	----------

Push-in type jumper bar; insulated; I_N 14 A; light gray

2-way	2000-402	25
3-way	2000-403	25
4-way	2000-404	25
5-way	2000-405	25
6-way	2000-406	25
7-way	2000-407	25
8-way	2000-408	25
9-way	2000-409	25
10-way	2000-410	25

Colored push-in type jumper bar

red	.../000-005
blue	.../000-006
yellow-green	.../000-018

Push-in type jumper bar; insulated; I_N 14 A; light gray

1 to 3	2000-433	25
1 to 4	2000-434	25
1 to 5	2000-435	25
1 to 6	2000-436	25
1 to 7	2000-437	25
1 to 8	2000-438	25
1 to 9	2000-439	25
1 to 10	2000-440	25

Double-deck marker carrier; pivoting

gray	2000-121	50 (25)
------	----------	---------

Marking strip; plain; 11 mm wide; 50 m reel

white	2009-110	1
-------	----------	---

WMB marking card; white; 10 strips with 10 markers/card; for 3.5 mm terminal block width

plain	793-3501	5
-------	----------	---

Operating tool with a partially insulated shaft; type 1; (2.5 x 0.4) mm blade

	210-719	1
--	---------	---

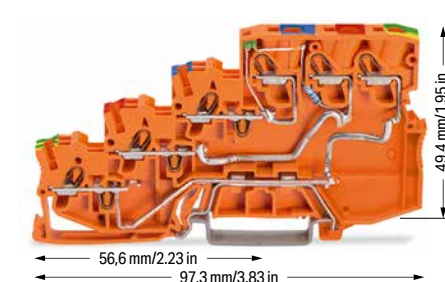
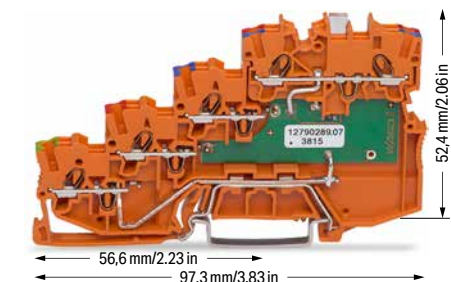

2000-5477/1102-953

2000-5477

2000-5457/1102-953

2000-5457

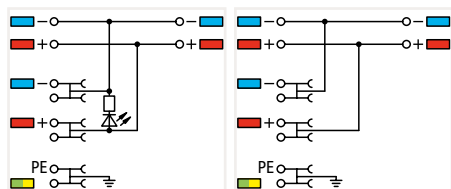

4-conductor sensor LED supply terminal block; green LED; 24 VDC; with ground connection

Color	Item No.	Pack. Unit
orange	2000-5477/1102-953	15

4-conductor sensor supply terminal block; max. 250 V; internally commoned; with ground connection

orange	2000-5477	15
--------	-----------	----

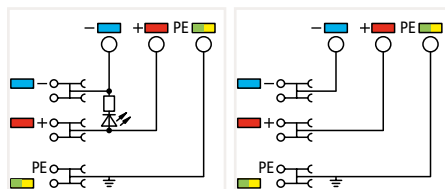

3-conductor sensor LED supply terminal block; green LED; 24 VDC control panel side: 2.5 (4) mm²; max. 28 A

Color	Item No.	Pack. Unit
orange	2000-5457/1102-953	15

4-conductor sensor supply terminal block; max. 250 V; with ground connection; control panel side: 2.5 (4) mm²; max. 28 A

orange	2000-5457	15
--------	-----------	----

3-Conductor Actuator Terminal Block TOPJOB® S

1 (1.5) mm²; 2000 Series

1

Technical Data	
0.14 ... 1 (1.5) mm ² ①	24 ... 16 AWG
250 V/4 kV/3 ②	300 V, 15 A ③
I _N 13.5 A	300 V, 10 A ④
Terminal block width: 7 mm / 0.276 inch ⑤	
9 ... 11 mm / 0.35 ... 0.43 inch	

Technical Data	
0.14 ... 1 (1.5) mm ² ①	24 ... 16 AWG
24 VDC	24 V, 15 A ③
I _N 13.5 A	24 V, 10 A ④
Terminal block width: 7 mm / 0.276 inch ⑤	
9 ... 11 mm / 0.35 ... 0.43 inch	

- ① Conductor range: 0.14 ... 1.5 mm² "s+f-st"; Push-in termination: 0.5 ... 1.5 mm² "s" and 0.5 ... 0.75 mm² "insulated ferrules; 10 mm" Depending on the conductor characteristic, a conductor with a smaller cross section can also be inserted via push-in termination.
 - ② 250 V = rated voltage
4 kV = rated impulse voltage
3 = pollution degree (see Section 15)
 - ③ 3.5 mm spacing per signal (2 x 3.5 mm = 7 mm)
Note:
The double spacing per pole of this terminal block series maximizes connectivity. For example, ten sensors may be connected using only five sensor terminal blocks plus a power supply terminal block.
- Please observe the application notes:
Jumpers, from page 174
- Approvals and corresponding ratings, visit www.wago.com

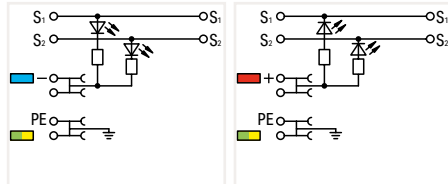
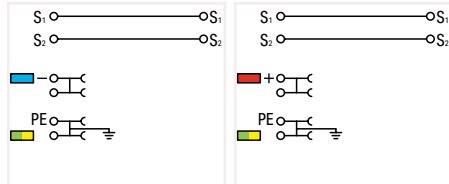
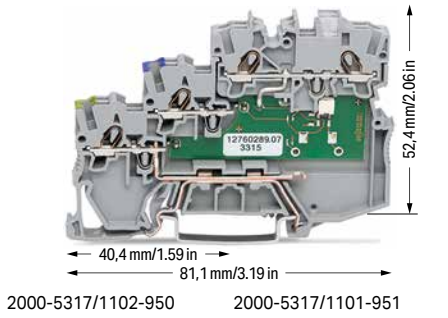
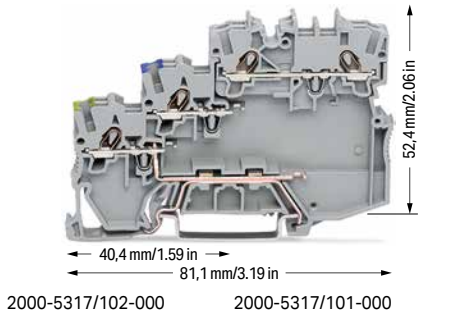

3-conductor actuator terminal block; for PNP (high-side) switching actuators; with ground connection

Color	Item No.	Pack. Unit
gray	2000-5317/102-000	50

3-conductor actuator terminal block; yellow LED; for PNP (high-side) switching actuators; with ground connection

Color	Item No.	Pack. Unit
gray	2000-5317/1102-950	50

3-conductor actuator terminal block; for NPN (low-side) switching actuators; with ground connection

Color	Item No.	Pack. Unit
gray	2000-5317/101-000	50

3-conductor actuator terminal block; yellow LED; for NPN (low-side) switching actuators; with ground connection

Color	Item No.	Pack. Unit
gray	2000-5317/1101-951	50

Accessories; for 3-conductor terminal blocks
Appropriate marking systems:
WMB/WMB Inline/Marking strips

End and intermediate plate; 1 mm thick; for 3-conductor terminal blocks

gray	2000-5391	100 (25)
------	-----------	----------

Push-in type jumper bar; insulated; I_N 14 A; light gray

2-way	2000-402	25
3-way	2000-403	25
4-way	2000-404	25
5-way	2000-405	25
6-way	2000-406	25
7-way	2000-407	25
8-way	2000-408	25
9-way	2000-409	25
10-way	2000-410	25

Colored push-in type jumper bar

red	.../000-005
blue	.../000-006
yellow-green	.../000-018

Push-in type jumper bar; insulated; I_N 14 A; light gray

1 to 3	2000-433	25
1 to 4	2000-434	25
1 to 5	2000-435	25
1 to 6	2000-436	25
1 to 7	2000-437	25
1 to 8	2000-438	25
1 to 9	2000-439	25
1 to 10	2000-440	25

Double-deck marker carrier; pivoting

gray	2000-121	50 (25)
------	----------	---------

Marking strip; plain; 11 mm wide; 50 m reel

white	2009-110	1
-------	----------	---

WMB marking card; white; 10 strips with 10 markers/card; for 3.5 mm terminal block width

plain	793-3501	5
-------	----------	---

Operating tool with a partially insulated shaft; type 1; (2.5 x 0.4) mm blade

	210-719	1
--	---------	---

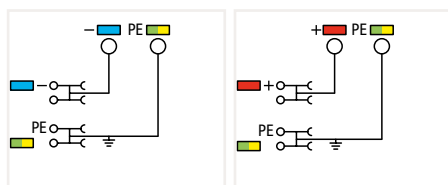
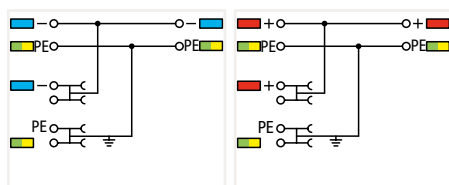
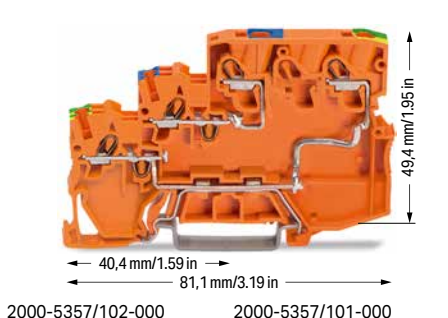
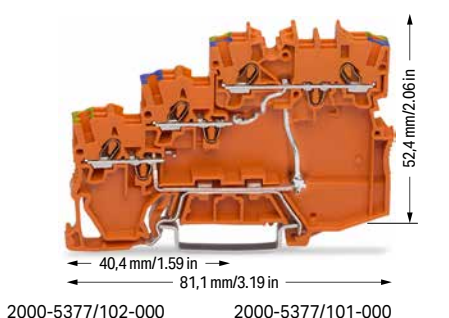

3-conductor actuator supply terminal block; max. 250 V; for PNP (high-side) switching actuators; with ground connection; internally commoned

Color	Item No.	Pack. Unit
orange	2000-5377/102-000	15

3-conductor actuator supply terminal block; max. 250 V; control panel side: 2.5 (4) mm²; max. 28 A; for PNP (high-side) switching actuators; with ground connection

Color	Item No.	Pack. Unit
orange	2000-5357/102-000	15

3-conductor actuator supply terminal block; max. 250 V; for NPN (low-side) switching actuators; with ground connection

Color	Item No.	Pack. Unit
orange	2000-5377/101-000	15

3-conductor actuator supply terminal block; max. 250 V; control panel side: 2.5 (4) mm²; max. 28 A; for NPN (low-side) switching actuators; with ground connection

Color	Item No.	Pack. Unit
orange	2000-5357/101-000	15

4-Conductor Sensor Terminal Block and 3-Conductor Actuator Terminal Block TOPJOB® S 1 (1.5) mm²; 2000 Series

Technical Data	
0.14 ... 1 (1.5) mm ² ①	24 ... 16 AWG
250 V/4 kV/3 ②	300 V, 15 A ③
I _N 13.5 A	300 V, 10 A ④
Terminal block width: 7 mm / 0.276 inch ⑤	
9 ... 11 mm / 0.35 ... 0.43 inch	



2000-5410

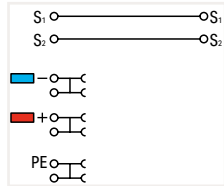

4-conductor sensor terminal block; with ground via push-in type jumper bar

Color	Item No.	Pack. Unit
○ gray	2000-5410	50

Technical Data	
0.14 ... 1 (1.5) mm ² ①	24 ... 16 AWG
24 VDC	24 V, 15 A ③
I _N 13.5 A	24 V, 10 A ④
Terminal block width: 7 mm / 0.276 inch ⑤	
9 ... 11 mm / 0.35 ... 0.43 inch	

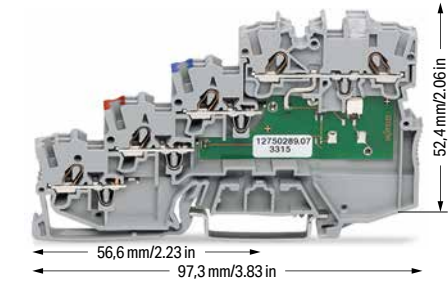

2000-5410/1102-950 2000-5410/1101-951

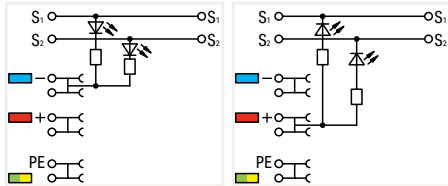

4-conductor sensor LED terminal block; yellow LED; for PNP (high-side) switching sensors; with ground via push-in type jumper bar

Color	Item No.	Pack. Unit
○ gray	2000-5410/1102-950	50

4-conductor sensor LED terminal block; yellow LED; for NPN (low-side) switching sensors; with ground via push-in type jumper bar

Color	Item No.	Pack. Unit
○ gray	2000-5410/1101-951	50

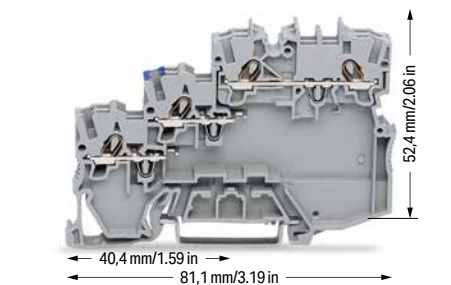

2000-5310/102-000

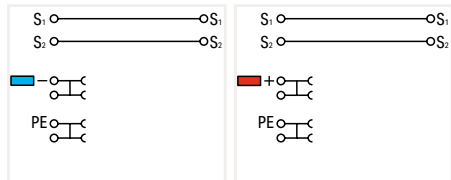

3-conductor actuator terminal block; for PNP (high-side) switching actuators; with ground via push-in type jumper bar

Color	Item No.	Pack. Unit
○ gray	2000-5310/102-000	50

3-conductor actuator terminal block; for NPN (low-side) switching actuators; with ground via push-in type jumper bar

Color	Item No.	Pack. Unit
○ gray	2000-5310/101-000	50

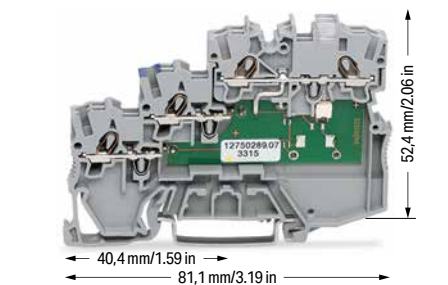

2000-5310/1102-950 2000-5310/1101-951

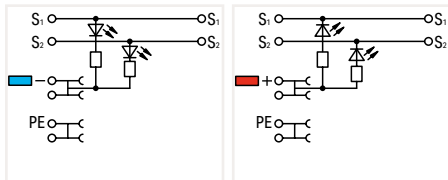

3-conductor actuator terminal block; yellow LED; for PNP (high-side) switching actuators; with ground via push-in type jumper bar

Color	Item No.	Pack. Unit
○ gray	2000-5310/1102-950	50

3-conductor actuator terminal block; yellow LED; for NPN (low-side) switching actuators; with ground via push-in type jumper bar

Color	Item No.	Pack. Unit
○ gray	2000-5310/1101-951	50

① Conductor range: 0.14 ... 1.5 mm² "s-ft-st"; Push-in termination: 0.5 ... 1.5 mm² "s" and 0.5 ... 0.75 mm² "insulated ferrules; 10 mm" Depending on the conductor characteristic, a conductor with a smaller cross section can also be inserted via push-in termination.

② 250 V = rated voltage
4 kV = rated impulse voltage
3 = pollution degree (see Section 15)

③ 3.5 mm spacing per signal (2 x 3.5 mm = 7 mm)
Note:
The double spacing per pole of this terminal block series maximizes connectivity. For example, ten sensors may be connected using only five sensor terminal blocks plus a power supply terminal block.

Please observe the application notes: Jumpers, from page 174

Approvals and corresponding ratings, visit www.wago.com

Accessories; for 4-conductor terminal blocks

Appropriate marking systems:
WMB/WMB Inline/Marking strips

End and intermediate plate; 1 mm thick; for 4-conductor terminal blocks

	gray	2000-5491	100 (25)
--	------	-----------	----------

Push-in type jumper bar; insulated; I_N 14 A; light gray

	2-way	2000-402	25
	3-way	2000-403	25
	4-way	2000-404	25
	5-way	2000-405	25
	6-way	2000-406	25
	7-way	2000-407	25
	8-way	2000-408	25
	9-way	2000-409	25
	10-way	2000-410	25

Colored push-in type jumper bar

	red	.../000-005
	blue	.../000-006
	yellow-green	.../000-018

Push-in type jumper bar; insulated; I_N 14 A; light gray

	1 to 3	2000-433	25
	1 to 4	2000-434	25
	1 to 5	2000-435	25
	1 to 6	2000-436	25
	1 to 7	2000-437	25
	1 to 8	2000-438	25
	1 to 9	2000-439	25
	1 to 10	2000-440	25

Double-deck marker carrier; pivoting

	gray	2000-121	50 (25)
--	------	----------	---------

Marking strip; plain; 11 mm wide; 50 m reel

	white	2009-110	1
--	-------	----------	---

WMB marking card; white; 10 strips with 10 markers/card; for 3.5 mm terminal block width

	plain	793-3501	5
--	-------	----------	---

Operating tool with a partially insulated shaft; type 1; (2.5 x 0.4) mm blade

		210-719	1
--	--	---------	---

PUSH-IN CAGE CLAMP®

Sensor Terminal Blocks and Actuator Terminal Blocks TOPJOB® S; with Pluggable Signal Level 2020 Series

Description and Installation

1

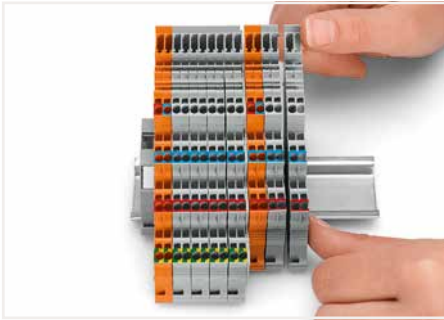

Snap individual terminal blocks onto the DIN-rail and slide together.



Separate terminal block assembly and slide individual terminal blocks laterally using an operating tool.

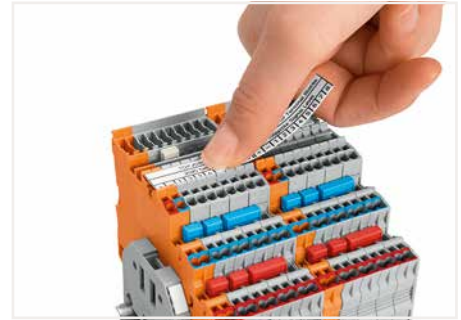

Labeling terminal blocks via marking strips (2009-110) or 3.5 mm wide WMB markers (793-35xx) – from the top or the side.

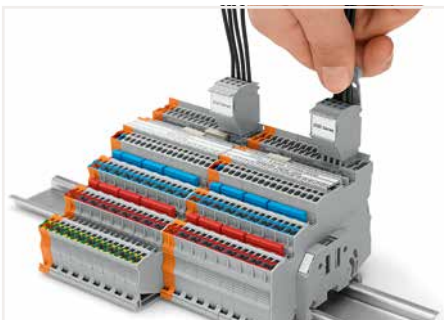

Removing a female plug via conductor bundle provided with strain relief plate.

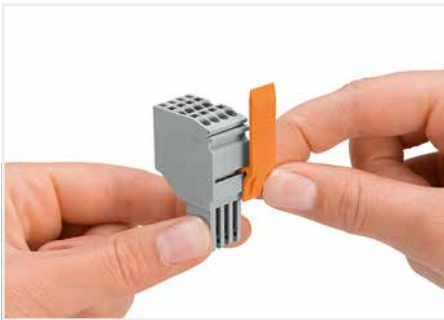

Slide the locking lever into position.

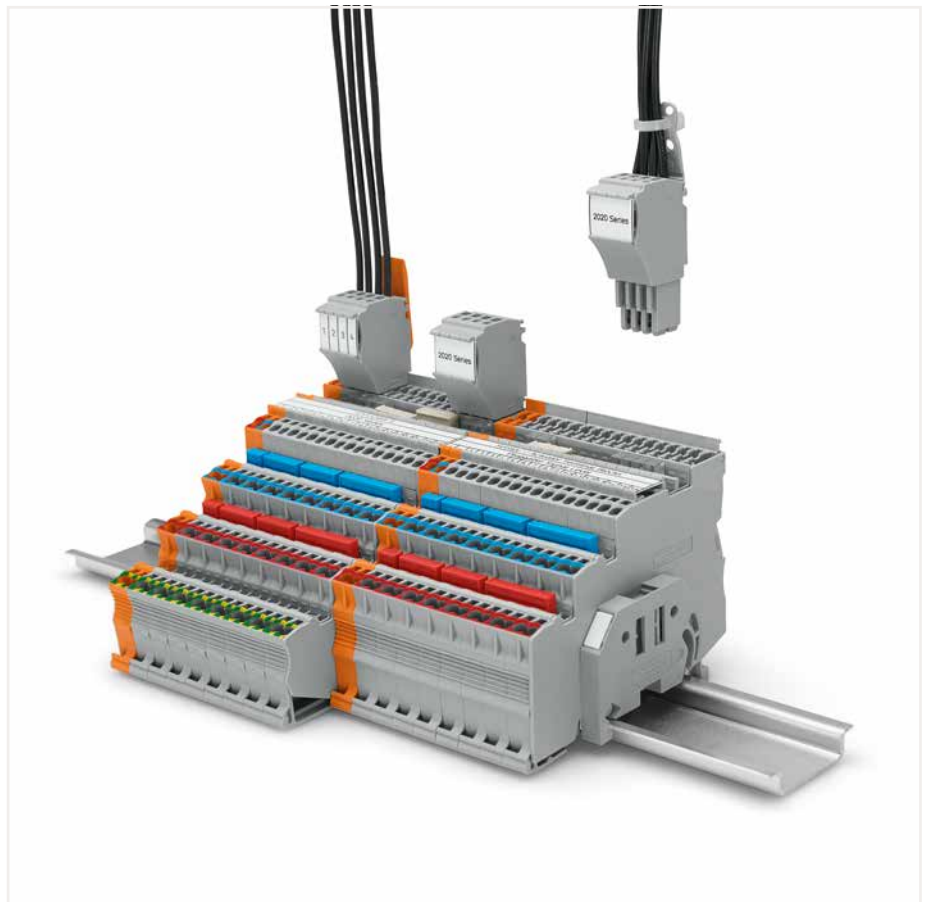

Testing via testing tap (2009-182) or test plug adapter (2009-174) (up to max. 42 V).

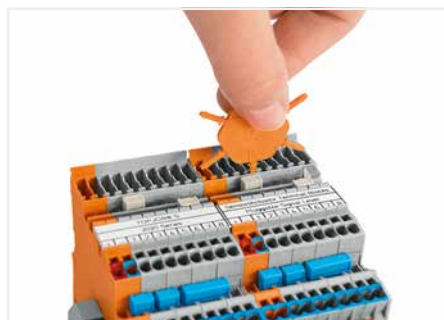

Insert coding pin into the corresponding slot and twist it off.



Remove the coding finger using a cutting tool.

3-Conductor Sensor Terminal Block TOPJOB® S; with Pluggable Signal Level 1 (1.5) mm²; 2020 Series

Technical Data	
0.14 ... 1 (1.5) mm ² ①	24 ... 16 AWG
250 V/4 kV/3 ②	300 V, 15 A ③
I _N 13.5 A	300 V, 10 A ④
Terminal block width: 7 mm / 0.276 inch ⑤	
9 ... 11 mm / 0.35 ... 0.43 inch	

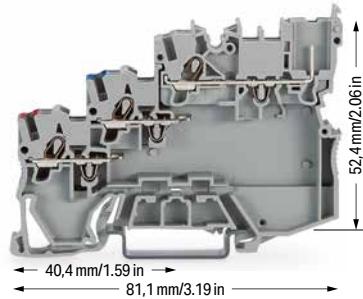

2020-5311

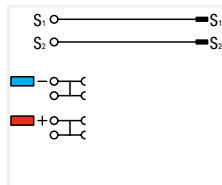

3-conductor sensor terminal block; with pluggable signal level

Color	Item No.	Pack. Unit
gray	2020-5311	50

Note:

According to EN 61984, pluggable connectors without a current interrupting capacity must not be mated or unmated when live or under load. An appropriate end plate must be applied to the carrier terminal blocks after each female plug.

Technical Data	
0.14 ... 1 (1.5) mm ² ①	24 ... 16 AWG
24 VDC	24 V, 15 A ③
I _N 13.5 A	24 V, 10 A ④
Terminal block width: 7 mm / 0.276 inch ⑤	
9 ... 11 mm / 0.35 ... 0.43 inch	

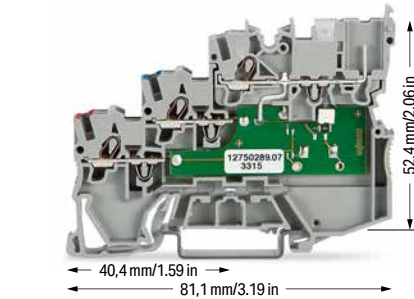

2020-5311/1102-950

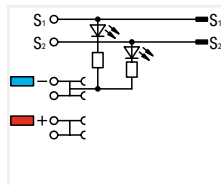

3-conductor sensor terminal block; yellow LED; for PNP (high-side) switching sensors; with pluggable signal level

Color	Item No.	Pack. Unit
gray	2020-5311/1102-950	50

① Conductor range: 0.14 ... 1.5 mm² "s+f-st"; Push-in termination: 0.5 ... 1.5 mm² "s" and 0.5 ... 0.75 mm² "insulated ferrules; 10 mm" Depending on the conductor characteristic, a conductor with a smaller cross section can also be inserted via push-in termination.

② 250 V = rated voltage
4 kV = rated impulse voltage
3 = pollution degree (see Section 15)

③ 3.5 mm spacing per signal (2 x 3.5 mm = 7 mm)
Note:
The double spacing per pole of this terminal block series maximizes connectivity. For example, ten sensors may be connected using only five sensor terminal blocks plus a power supply terminal block.

Please observe the application notes: Jumpers, from page 174

Approvals and corresponding ratings, visit www.wago.com

Accessories; for 3-conductor terminal blocks
Appropriate marking systems:
WMB/WMB Inline/Marking strips

End and intermediate plate; 1 mm thick; for 3-conductor terminal blocks

	gray	2020-5391	100 (25)
--	------	-----------	----------

Push-in type jumper bar; insulated; I_N 14 A; light gray

	2-way	2000-402	25
	3-way	2000-403	25
	4-way	2000-404	25
	5-way	2000-405	25
	6-way	2000-406	25
	7-way	2000-407	25
	8-way	2000-408	25
	9-way	2000-409	25
	10-way	2000-410	25

Colored push-in type jumper bar

	red	.../000-005
	blue	.../000-006

Push-in type jumper bar; insulated; I_N 14 A; light gray

	1 to 3	2000-433	25
	1 to 4	2000-434	25
	1 to 5	2000-435	25
	1 to 6	2000-436	25
	1 to 7	2000-437	25
	1 to 8	2000-438	25
	1 to 9	2000-439	25
	1 to 10	2000-440	25

Carrier with 6 coding pins; for coding female plugs

	orange	2020-100	100 (25)
--	--------	----------	----------

1-conductor female plug

	gray	2020-102	100
--	------	----------	-----

2-conductor female plug

	gray	2020-202	100
--	------	----------	-----

Test plug adapter; for 4 mm Ø test plug

	gray	2009-174	100 (25)
--	------	----------	----------

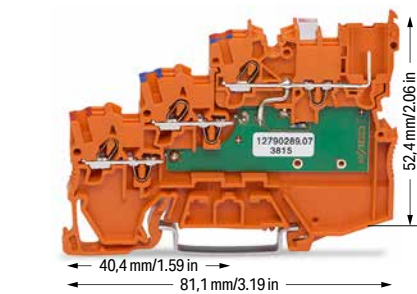

2020-5372/1102-953

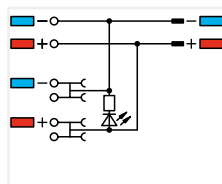

3-conductor sensor LED supply terminal block; green LED; 24 VDC; with pluggable signal level

Color	Item No.	Pack. Unit
orange	2020-5372/1102-953	15

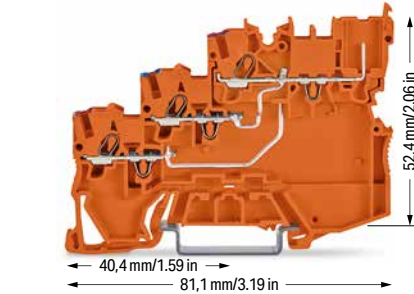

2020-5372

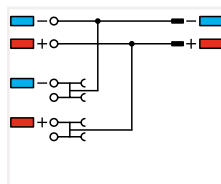

3-conductor sensor supply terminal block; max. 250 V; internally commoned; with pluggable signal level

Color	Item No.	Pack. Unit
orange	2020-5372	50

4-Conductor Sensor Terminal Block TOPJOB® S; with Pluggable Signal Level 1 (1.5) mm²; 2020 Series

1

Technical Data	
0.14 ... 1 (1.5) mm ² ①	24 ... 16 AWG
250 V/4 kV/3 ②	300 V, 15 A ③
I _N 13.5 A	300 V, 10 A ④
Terminal block width: 7 mm / 0.276 inch ⑤	
9 ... 11 mm / 0.35 ... 0.43 inch	

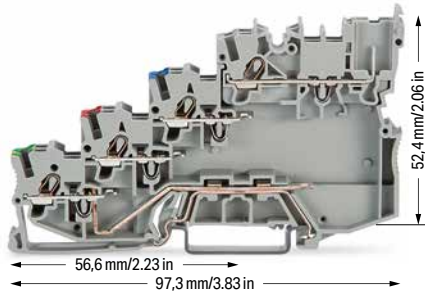

2020-5417

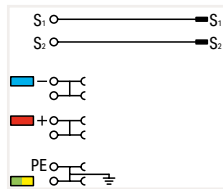

4-conductor sensor terminal block; with ground connection; with pluggable signal level

Color	Item No.	Pack. Unit
gray	2020-5417	50

Note:

According to EN 61984, pluggable connectors without a current interrupting capacity must not be mated or unmated when live or under load. An appropriate end plate must be applied to the carrier terminal blocks after each female plug.

Technical Data	
0.14 ... 1 (1.5) mm ² ①	24 ... 16 AWG
24 VDC	24 V, 15 A ③
I _N 13.5 A	24 V, 10 A ④
Terminal block width: 7 mm / 0.276 inch ⑤	
9 ... 11 mm / 0.35 ... 0.43 inch	

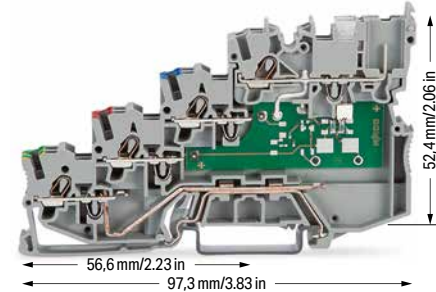

2020-5417/1102-950

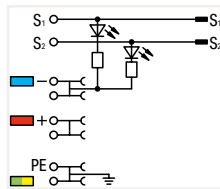

4-conductor sensor terminal block; yellow LED; for PNP (high-side) switching sensors; with ground connection; with pluggable signal level

Color	Item No.	Pack. Unit
gray	2020-5417/1102-950	50

① Conductor range: 0.14 ... 1.5 mm² "s+f-st"; Push-in termination: 0.5 ... 1.5 mm² "s" and 0.5 ... 0.75 mm² "insulated ferrules; 10 mm" Depending on the conductor characteristic, a conductor with a smaller cross section can also be inserted via push-in termination.

② 250 V = rated voltage
4 kV = rated impulse voltage
3 = pollution degree (see Section 15)

③ 3.5 mm spacing per signal (2 x 3.5 mm = 7 mm)
Note:
The double spacing per pole of this terminal block series maximizes connectivity. For example, ten sensors may be connected using only five sensor terminal blocks plus a power supply terminal block.

Please observe the application notes: Jumpers, from page 174

Approvals and corresponding ratings, visit www.wago.com

Accessories; for 4-conductor terminal blocks

Appropriate marking systems:
WMB/WMB Inline/Marking strips

End and intermediate plate; 1 mm thick; for 4-conductor terminal blocks

gray	2020-5491	100 (25)
------	-----------	----------

Push-in type jumper bar; insulated; I_N 14 A; light gray

2-way	2000-402	25
3-way	2000-403	25
4-way	2000-404	25
5-way	2000-405	25
6-way	2000-406	25
7-way	2000-407	25
8-way	2000-408	25
9-way	2000-409	25
10-way	2000-410	25

Colored push-in type jumper bar

- red .../000-005
- blue .../000-006
- yellow-green .../000-018

Push-in type jumper bar; insulated; I_N 14 A; light gray

1 to 3	2000-433	25
1 to 4	2000-434	25
1 to 5	2000-435	25
1 to 6	2000-436	25
1 to 7	2000-437	25
1 to 8	2000-438	25
1 to 9	2000-439	25
1 to 10	2000-440	25

Carrier with 6 coding pins; for coding female plugs

orange	2020-100	100 (25)
--------	----------	----------

1-conductor female plug

gray	2020-102	100
------	----------	-----

2-conductor female plug

gray	2020-202	100
------	----------	-----

Test plug adapter; for 4 mm Ø test plug

gray	2009-174	100 (25)
------	----------	----------

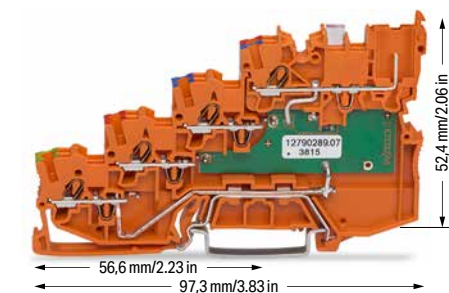

2020-5477/1102-953

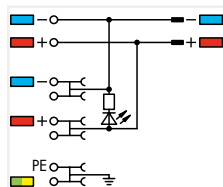

4-conductor sensor LED supply terminal block; green LED; 24 VDC; with ground connection; with pluggable signal level

Color	Item No.	Pack. Unit
orange	2020-5477/1102-953	15

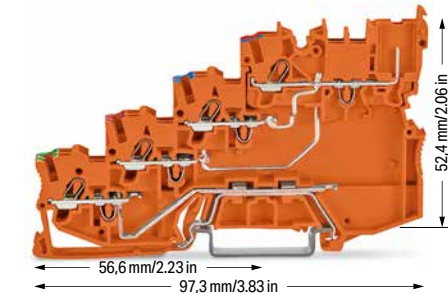

2020-5477

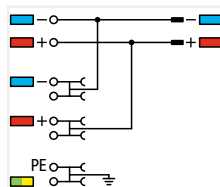

4-conductor sensor supply terminal block; max. 250 V; internally commoned; with ground connection; with pluggable signal level

Color	Item No.	Pack. Unit
orange	2020-5477	50

3-Conductor Actuator Terminal Block TOPJOB® S; with Pluggable Signal Level 1 (1.5) mm²; 2020 Series

Technical Data	
0.14 ... 1 (1.5) mm ² ①	24 ... 16 AWG
250 V/4 kV/3 ②	300 V, 15 A ③
I _N 13.5 A	300 V, 10 A ④
Terminal block width: 7 mm / 0.276 inch ⑤	
9 ... 11 mm / 0.35 ... 0.43 inch	

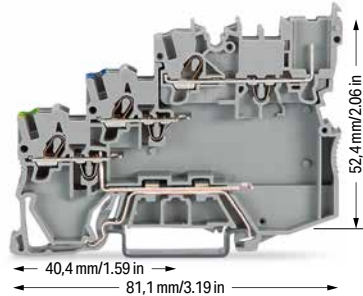

2020-5317/102-000

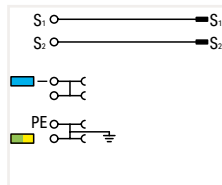

3-conductor actuator terminal block; for PNP (high-side) switching actuators; with ground connection; with pluggable signal level

Color	Item No.	Pack. Unit
gray	2020-5317/102-000	50

Note:

According to EN 61984, pluggable connectors without a current interrupting capacity must not be mated or unmated when live or under load. An appropriate end plate must be applied to the carrier terminal blocks after each female plug.

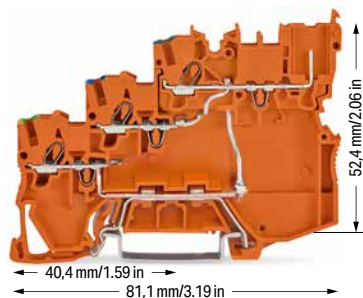

2020-5377/102-000

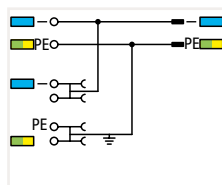

3-conductor actuator supply terminal block; for PNP (high-side) switching actuators; with ground connection; internally commoned; with pluggable signal level

Color	Item No.	Pack. Unit
orange	2020-5377/102-000	15

Technical Data	
0.14 ... 1 (1.5) mm ² ①	24 ... 16 AWG
24 VDC	24 V, 15 A ③
I _N 13.5 A	24 V, 10 A ④
Terminal block width: 7 mm / 0.276 inch ⑤	
9 ... 11 mm / 0.35 ... 0.43 inch	

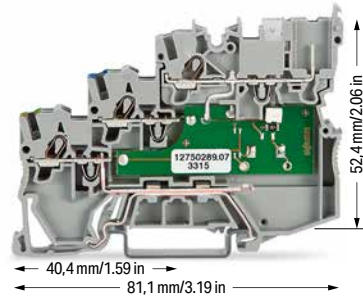

2020-5317/1102-950

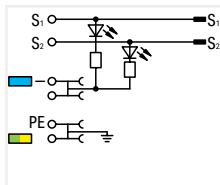

3-conductor actuator terminal block; yellow LED; for PNP (high-side) switching actuators; with ground connection; with pluggable signal level

Color	Item No.	Pack. Unit
gray	2020-5317/1102-950	50

- ① Conductor range: 0.14 ... 1.5 mm² "s-ft"; Push-in termination: 0.5 ... 1.5 mm² "s" and 0.5 ... 0.75 mm² "insulated ferrules; 10 mm" Depending on the conductor characteristic, a conductor with a smaller cross section can also be inserted via push-in termination.
 - ② 250 V = rated voltage
4 kV = rated impulse voltage
3 = pollution degree (see Section 15)
 - ③ 3.5 mm spacing per signal (2 x 3.5 mm = 7 mm)
Note:
The double spacing per pole of this terminal block series maximizes connectivity. For example, ten sensors may be connected using only five sensor terminal blocks plus a power supply terminal block.
- Please observe the application notes:
Jumpers, from page 174
- Approvals and corresponding ratings, visit www.wago.com

Accessories; for 3-conductor terminal blocks

Appropriate marking systems:
WMB/WMB Inline/Marking strips

End and intermediate plate; 1 mm thick; for 3-conductor terminal blocks

	gray	2020-5391	100 (25)
--	------	-----------	----------

Push-in type jumper bar; insulated; I_N 14 A; light gray

	2-way	2000-402	25
	3-way	2000-403	25
	4-way	2000-404	25
	5-way	2000-405	25
	6-way	2000-406	25
	7-way	2000-407	25
	8-way	2000-408	25
	9-way	2000-409	25
	10-way	2000-410	25

Colored push-in type jumper bar

- red .../000-005
- blue .../000-006
- yellow-green .../000-018

Push-in type jumper bar; insulated; I_N 14 A; light gray

	1 to 3	2000-433	25
	1 to 4	2000-434	25
	1 to 5	2000-435	25
	1 to 6	2000-436	25
	1 to 7	2000-437	25
	1 to 8	2000-438	25
	1 to 9	2000-439	25
	1 to 10	2000-440	25

Carrier with 6 coding pins; for coding female plugs

	orange	2020-100	100 (25)
--	--------	----------	----------

1-conductor female plug

	gray	2020-102	100
--	------	----------	-----

2-conductor female plug

	gray	2020-202	100
--	------	----------	-----

Test plug adapter; for 4 mm Ø test plug

	gray	2009-174	100 (25)
--	------	----------	----------

Diode Terminal Block, LED Terminal Block TOPJOB® S

1.5 (2.5) mm²; 2001 Series

1

Technical Data	
0.25 ... 1.5 (2.5) mm ² ①	22 ... 14 AWG
U _N 250 V; U _{RM} 1000 V	
1N4007 - 0.5 A continuous current	
Terminal block width: 4.2 mm / 0.165 inch	
9 ... 11 mm / 0.35 ... 0.43 inch	

Technical Data	
0.25 ... 1.5 (2.5) mm ² ①	22 ... 14 AWG
U _N 250 V; U _{RM} 1000 V	
1N4007 - 0.5 A continuous current	
Terminal block width: 4.2 mm / 0.165 inch	
9 ... 11 mm / 0.35 ... 0.43 inch	

Technical Data	
0.25 ... 1.5 (2.5) mm ² ①	22 ... 14 AWG
24 VDC	
I _F 0.025 A max.	
Terminal block width: 4.2 mm / 0.165 inch	
9 ... 11 mm / 0.35 ... 0.43 inch	

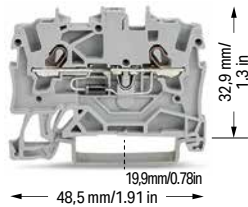

2001-1211/1000-411 2001-1211/1000-410



2001-1311/1000-411 2001-1311/1000-410

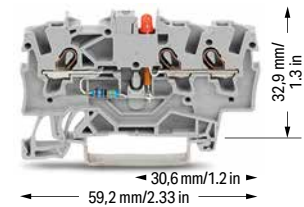

2001-1321/1000-434 2001-1321/1000-413

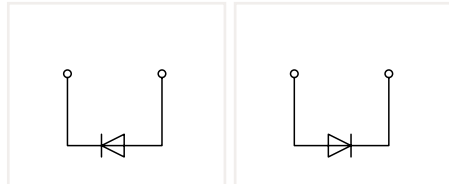

2-conductor diode terminal block; with 1N4007 diode

	Item No.	Pack. Unit
○ anode right	2001-1211/1000-411	100
○ anode left	2001-1211/1000-410	100

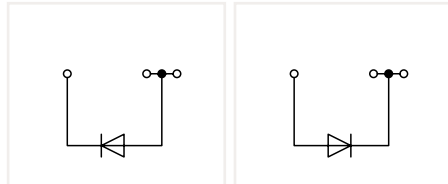

3-conductor diode terminal block; with 1N4007 diode

	Item No.	Pack. Unit
○ anode right	2001-1311/1000-411	100
○ anode left	2001-1311/1000-410	100

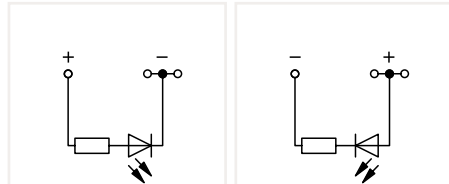

3-conductor LED terminal block; with red LED
Notice: This LED terminal block cannot be commoned with push-in type jumper bars.

	Item No.	Pack. Unit
○ anode right	2001-1321/1000-434	100
○ anode left	2001-1321/1000-413	100

Other terminal blocks with the same profile:		
Through	2001-1201	Page 56

Other terminal blocks with the same profile:		
Through	2001-1301	Page 56

Other terminal blocks with the same profile:		
Through	2001-1301	Page 56

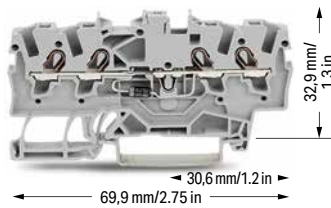

2001-1411/1000-411 2001-1411/1000-410

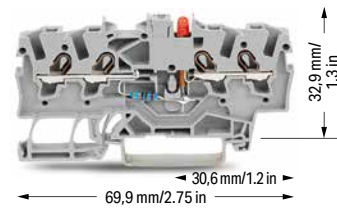

2001-1421/1000-434 2001-1421/1000-413

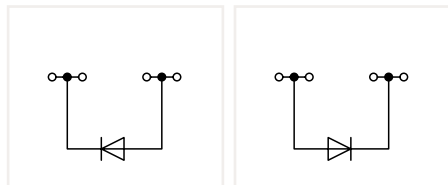

4-conductor diode terminal block; with 1N4007 diode

	Item No.	Pack. Unit
○ anode right	2001-1411/1000-411	100
○ anode left	2001-1411/1000-410	100

Other terminal blocks with the same profile:		
Through	2001-1401	Page 56

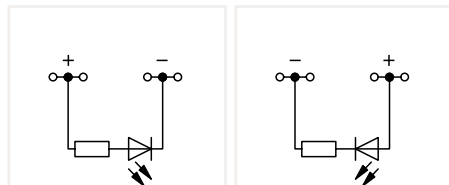

4-conductor LED terminal block; with red LED
Notice: This LED terminal block cannot be commoned with push-in type jumper bars.

	Item No.	Pack. Unit
○ anode right	2001-1421/1000-434	100
○ anode left	2001-1421/1000-413	100

Other terminal blocks with the same profile:		
Through	2001-1401	Page 56

Diode Terminal Blocks and LED Terminal Blocks TOPJOB® S Circuit Configuration Examples

① Conductor range: 0.25 ... 2.5 mm² "s+f-st";
Push-in termination: 0.75 ... 2.5 mm² "s" and
0.75 ... 1.5 mm² "insulated ferrules; 12 mm"
Depending on the conductor characteristic, a conductor
with a smaller cross section can also be inserted
via push-in termination.

Approvals and corresponding ratings,
visit www.wago.com

Accessories; 2001 Series
Appropriate marking systems:
WMB/WMB Inline/Marking strips

Insulation stop; 5 pcs/strip; 0.25 ... 0.5 mm²
light gray 2001-171 200 (25)



Push-in type jumper bar; insulated; I_n 18 A; light gray

2-way	2001-402	25
3-way	2001-403	25
4-way	2001-404	25
5-way	2001-405	25
6-way	2001-406	25
7-way	2001-407	25
8-way	2001-408	25
9-way	2001-409	25
10-way	2001-410	25



Push-in type jumper bar; insulated; I_n 18 A; light gray

1 to 3	2001-433	25
1 to 4	2001-434	25
1 to 5	2001-435	25
1 to 6	2001-436	25
1 to 7	2001-437	25
1 to 8	2001-438	25
1 to 9	2001-439	25
1 to 10	2001-440	25

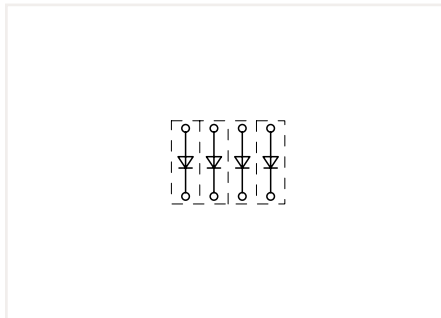

Open diode gates can be created using the following terminal blocks:
2001-1211/1000-410 or 2001-1211/1000-411



These diode terminal blocks have been specially developed for custom diode circuits, such as lamp test and collective fault signal circuits.

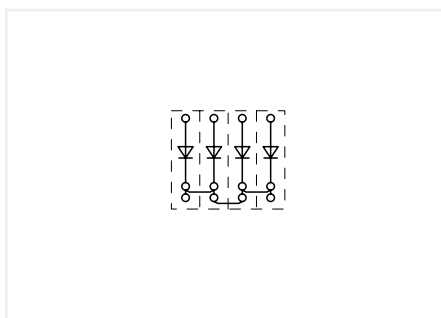

Polarized diode gates with a common cathode can be created using the following terminal blocks:
2001-1311/1000-410 or 2001-1311/1000-411

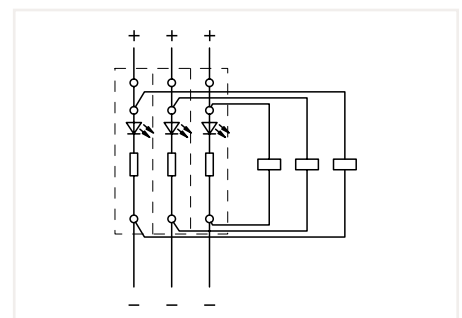

Circuit-related voltage indications can be created using the following terminal blocks:
2001-1321/1000-434 or 2001-1321/1000-413

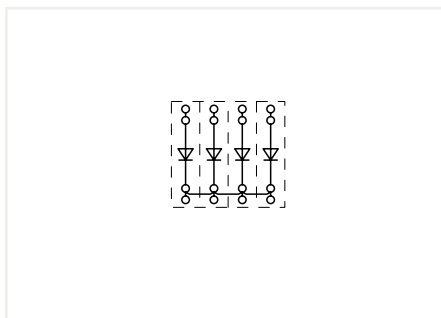

Polarized diode gates with a common cathode can be created using the following terminal blocks:
2001-1411/1000-410 or 2001-1411/1000-411

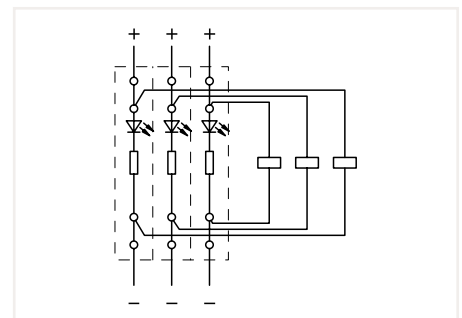

Circuit-related voltage indications can be created using the following terminal blocks:
2001-1421/1000-434 or 2001-1421/1000-413

Diode Terminal Block, LED Terminal Block TOPJOB® S

2.5 (4) mm²; 2002 Series

1

Technical Data	
0.25 ... 2.5 (4) mm ² ①	22 ... 12 AWG
U _N 250 V; U _{RM} 1000 V	
1N4007 - 0.5 A continuous current	
Terminal block width: 5.2 mm / 0.205 inch	
 10 ... 12 mm / 0.39 ... 0.47 inch	

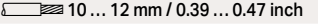
Technical Data	
0.25 ... 2.5 (4) mm ² ①	22 ... 12 AWG
U _N 250 V; U _{RM} 1000 V	
1N4007 - 0.5 A continuous current	
Terminal block width: 5.2 mm / 0.205 inch	
 10 ... 12 mm / 0.39 ... 0.47 inch	

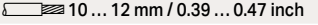
Technical Data	
0.25 ... 2.5 (4) mm ² ①	22 ... 12 AWG
24 VDC	
I _F 0.025 A max.	
Terminal block width: 5.2 mm / 0.205 inch	
 10 ... 12 mm / 0.39 ... 0.47 inch	

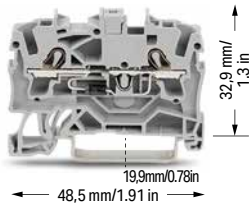

2002-1211/1000-411 2002-1211/1000-410

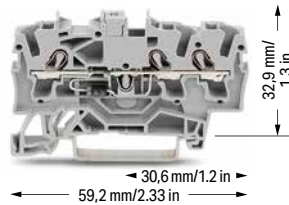

2002-1311/1000-411 2002-1311/1000-410

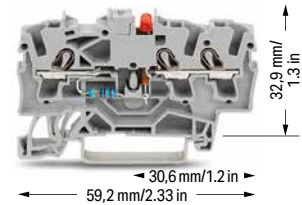

2002-1321/1000-434 2002-1321/1000-413

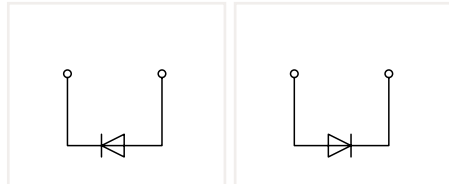

2-conductor diode terminal block; with 1N4007 diode

	Item No.	Pack. Unit
○ anode right	2002-1211/1000-411	100
○ anode left	2002-1211/1000-410	100

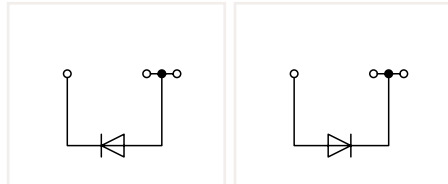

3-conductor diode terminal block; with 1N4007 diode

	Item No.	Pack. Unit
○ anode right	2002-1311/1000-411	100
○ anode left	2002-1311/1000-410	100

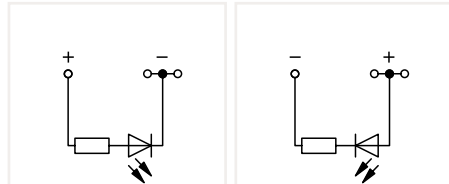

3-conductor LED terminal block; with red LED
Notice: This LED terminal block cannot be commoned with push-in type jumper bars.

	Item No.	Pack. Unit
○ anode right	2002-1321/1000-434	100
○ anode left	2002-1321/1000-413	100

Other terminal blocks with the same profile:		
Through	2002-1201	Page 58

Other terminal blocks with the same profile:		
Through	2002-1301	Page 58

Other terminal blocks with the same profile:		
Through	2002-1301	Page 58



2002-1411/1000-411 2002-1411/1000-410

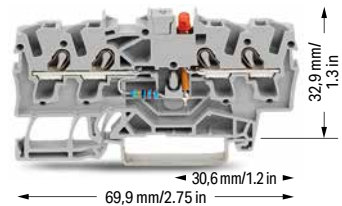

2002-1421/1000-434 2002-1421/1000-413

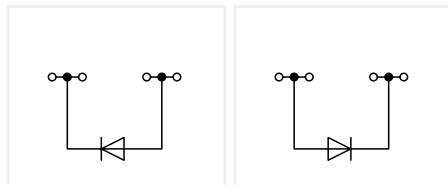

4-conductor diode terminal block; with 1N4007 diode

	Item No.	Pack. Unit
○ anode right	2002-1411/1000-411	100
○ anode left	2002-1411/1000-410	100

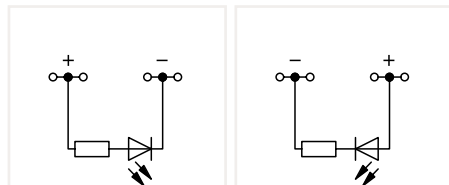

4-conductor LED terminal block; with red LED
Notice: This LED terminal block cannot be commoned with push-in type jumper bars.

	Item No.	Pack. Unit
○ anode right	2002-1421/1000-434	100
○ anode left	2002-1421/1000-413	100

Other terminal blocks with the same profile:		
Through	2002-1401	Page 58

Other terminal blocks with the same profile:		
Through	2002-1401	Page 58

Diode Terminal Blocks and LED Terminal Blocks TOPJOB® S Circuit Configuration Examples

❶ Conductor range: 0.25 ... 4 mm² "s+f-st";
Push-in termination: 1 ... 4 mm² "s" and 1 ... 2.5 mm²
"insulated ferrules, 12 mm"
Depending on the conductor characteristic, a conductor with a smaller cross section can also be inserted via push-in termination.

Approvals and corresponding ratings, visit www.wago.com

Accessories; 2002 Series
Appropriate marking systems:
WMB/WMB Inline/Marking strips

Insulation stop; 5 pcs/strip; 0.25 ... 0.5 mm²
light gray 2002-171 200 (25)



Insulation stop; 5 pcs/strip; 0.75 ... 1 mm²
dark gray 2002-172 200 (25)



Push-in type jumper bar; insulated; I_n 25 A; light gray

2-way	2002-402	25
3-way	2002-403	25
4-way	2002-404	25
5-way	2002-405	25
6-way	2002-406	25
7-way	2002-407	25
8-way	2002-408	25
9-way	2002-409	25
10-way	2002-410	25



Push-in type jumper bar; insulated; I_n 25 A; light gray

1 to 3	2002-433	25
1 to 4	2002-434	25
1 to 5	2002-435	25
1 to 6	2002-436	25
1 to 7	2002-437	25
1 to 8	2002-438	25
1 to 9	2002-439	25
1 to 10	2002-440	25

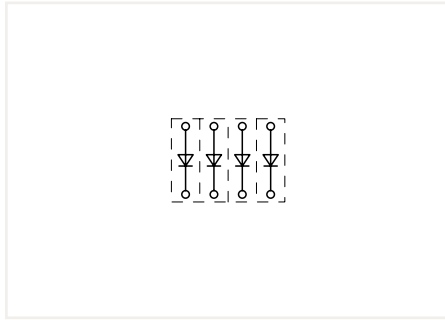

Open diode gates can be created using the following terminal blocks:
2002-1211/1000-410 or 2002-1211/1000-411

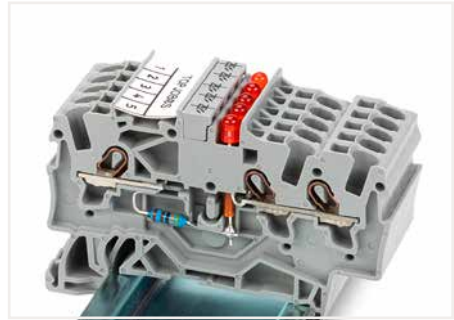

Using LED terminal blocks, monitoring units can be designed, e.g., for control and operating circuits.

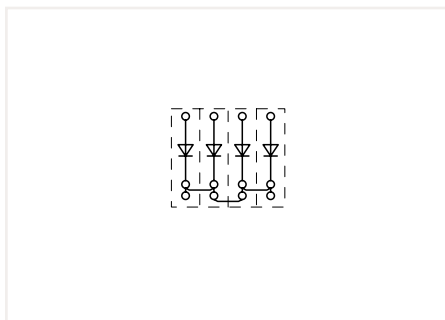

Polarized diode gates with a common cathode can be created using the following terminal blocks:
2002-1311/1000-410 or 2002-1311/1000-411

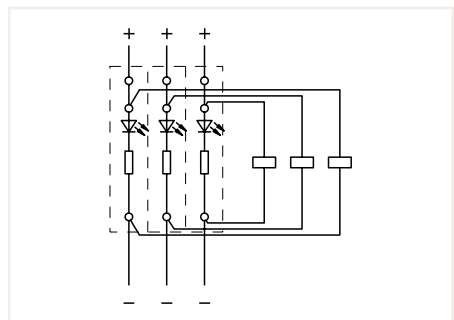

Circuit-related voltage indications can be created using the following terminal blocks:
2002-1321/1000-434 or 2002-1321/1000-413

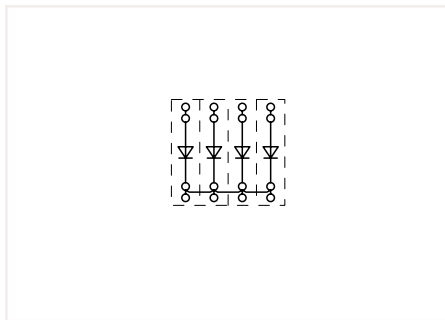

Polarized diode gates with a common cathode can be created using the following terminal blocks:
2002-1411/1000-410 or 2002-1411/1000-411

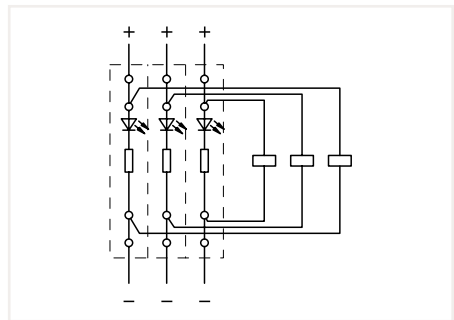



Circuit-related voltage indications can be created using the following terminal blocks:
2002-1421/1000-434 or 2002-1421/1000-413

Diode Terminal Block TOPJOB® S

4 (6) mm²; 2004 Series

1

Technical Data	
0.5 ... 4 (6) mm ² ①	20 ... 10 AWG
U _N 250 V; U _{RM} 1000 V	
1N5408 - 1.5 A continuous current	
Terminal block width: 6.2 mm / 0.244 inch	
 11 ... 13 mm / 0.43 ... 0.51 inch	

Technical Data	
0.5 ... 4 (6) mm ² ①	20 ... 10 AWG
U _N 250 V; U _{RM} 1000 V	
1N5408 - 1.5 A continuous current	
Terminal block width: 6.2 mm / 0.244 inch	
 11 ... 13 mm / 0.43 ... 0.51 inch	

Technical Data	
0.5 ... 4 (6) mm ² ①	20 ... 10 AWG
U _N 250 V; U _{RM} 1000 V	
1N5408 - 1.5 A continuous current	
Terminal block width: 6.2 mm / 0.244 inch	
 11 ... 13 mm / 0.43 ... 0.51 inch	

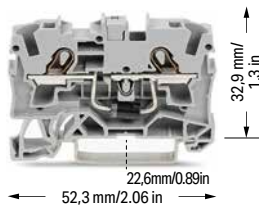

2004-1211/1000-401 2004-1211/1000-400

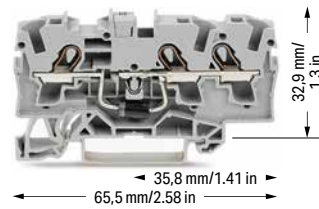

2004-1311/1000-401 2004-1311/1000-400

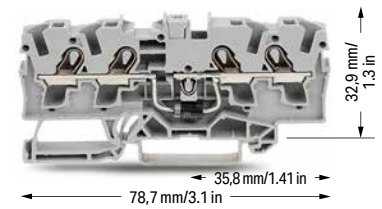

2004-1411/1000-401 2004-1411/1000-400

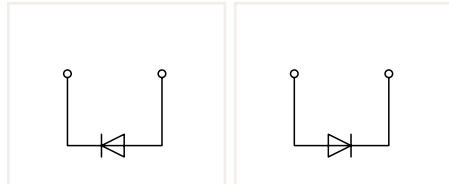

2-conductor diode terminal block; with 1N5408 diode		
	Item No.	Pack. Unit
○ anode right	2004-1211/1000-401	50
○ anode left	2004-1211/1000-400	50

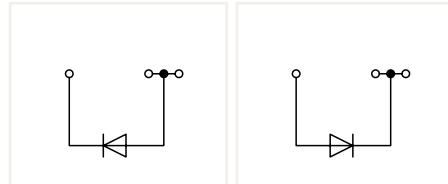

3-conductor diode terminal block; with 1N5408 diode		
	Item No.	Pack. Unit
○ anode right	2004-1311/1000-401	50
○ anode left	2004-1311/1000-400	50

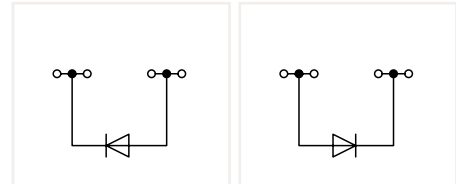

4-conductor diode terminal block; with 1N5408 diode		
	Item No.	Pack. Unit
○ anode right	2004-1411/1000-401	50
○ anode left	2004-1411/1000-400	50

Other terminal blocks with the same profile:		
Through	2004-1201	Page 62

Other terminal blocks with the same profile:		
Through	2004-1301	Page 62

Other terminal blocks with the same profile:		
Through	2004-1401	Page 62

Diode Terminal Blocks TOPJOB® S

Circuit Configuration Examples

1

① Conductor range: 0.5 ... 6 mm² "s+f-st";
 Push-in termination: 1.5 ... 6 mm² "s" and 1.5 ... 4 mm² "insulated ferrules; 12 mm"
 Depending on the conductor characteristic, a conductor with a smaller cross section can also be inserted via push-in termination.

Approvals and corresponding ratings, visit www.wago.com

Accessories; 2004 Series
 Appropriate marking systems:
 WMB/WMB Inline/Marking strips

Insulation stop; 5 pcs/strip; 0.25 ... 0.5 mm²
 light gray 2004-171 200 (25)

Insulation stop; 5 pcs/strip; 0.75 ... 1 mm²
 dark gray 2004-172 200 (25)

Push-in type jumper bar; insulated; I_N 32 A; light gray
 2-way 2004-402 25
 3-way 2004-403 25
 4-way 2004-404 25
 5-way 2004-405 25
 6-way 2004-406 25
 7-way 2004-407 25
 8-way 2004-408 25
 9-way 2004-409 25
 10-way 2004-410 25

Push-in type jumper bar; insulated; I_N 32 A; light gray
 1 to 3 2004-433 25
 1 to 4 2004-434 25
 1 to 5 2004-435 25
 1 to 6 2004-436 25
 1 to 7 2004-437 25
 1 to 8 2004-438 25
 1 to 9 2004-439 25
 1 to 10 2004-440 25

Wire commoning chain; 50 connections; insulated; I_N 8 A
 black 210-103 5

Wire commoning chain; 50 connections; insulated; I_N 8 A
 blue 210-123 5

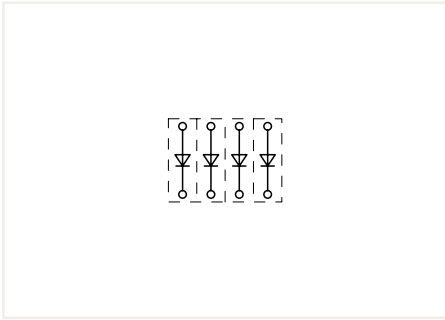

Open diode gates can be created using the following terminal blocks:
 2004-1211/1000-400 or 2004-1211/1000-401



These diode terminal blocks have been specially developed for custom diode circuits, such as lamp test and collective fault signal circuits.

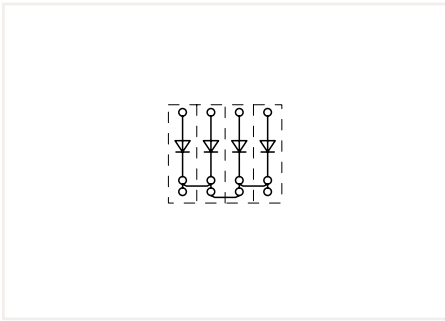

Polarized diode gates with a common cathode can be created using the following terminal blocks:
 2004-1311/1000-400 or 2004-1311/1000-401

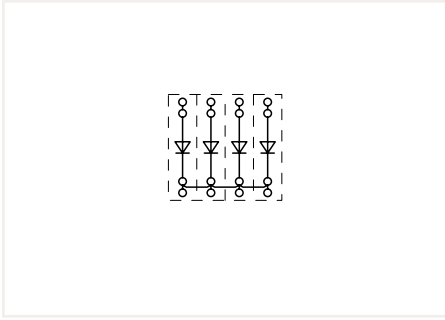

Polarized diode gates with a common cathode can be created using the following terminal blocks:
 2004-1411/1000-400 or 2004-1411/1000-401

Pluggable Diode Module TOPJOB® S on Carrier Terminal Block 2.5 (4) mm² 2002 Series

1

Technical Data	
U_N 250 V; U_{RM} 1000 V	
I_N 0.5 A	
Plug width: 5.2 mm / 0.205 inch	



2002-800/1000-411

2002-800/1000-410

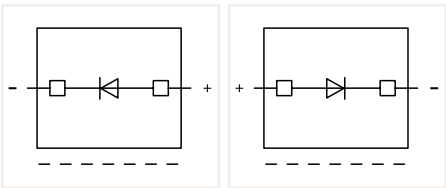

Diode module; with 1N4007 diode; max. operating temperature: 85°C; 5.2 mm wide

	Item No.	Pack. Unit
○ anode right	2002-800/1000-411	100
○ anode left	2002-800/1000-410	100

Accessories for Carrier Terminal Blocks
Appropriate marking systems:
WMB/Marking strips

2-conductor carrier terminal block;
0.25 ... 2.5 (4) mm² / 22 ... 12 AWG
Terminal block width: 5.2 mm / 0.205 inch

gray	2002-1661	50
------	-----------	----

2-conductor carrier terminal block; with push-button
0.25 ... 2.5 (4) mm² / 22 ... 12 AWG
Terminal block width: 5.2 mm / 0.205 inch

gray	2202-1661	50
------	-----------	----

End and intermediate plate; 1 mm thick

orange	2002-1692	100 (25)
gray	2002-1691	100 (25)

3-conductor carrier terminal block;
0.25 ... 2.5 (4) mm² / 22 ... 12 AWG
Terminal block width: 5.2 mm / 0.205 inch

gray	2002-1761	50
------	-----------	----

3-conductor carrier terminal block; with push-button
0.25 ... 2.5 (4) mm² / 22 ... 12 AWG
Terminal block width: 5.2 mm / 0.205 inch

gray	2202-1761	50
------	-----------	----

End and intermediate plate; 1 mm thick

orange	2002-1792	100 (25)
gray	2002-1791	100 (25)

Please observe the application notes:
Jumpers, from page 174
Marking, from page 640

Approvals and corresponding ratings,
visit www.wago.com

Accessories for Carrier Terminal Blocks
Appropriate marking systems:
WMB/Marking strips

4-conductor carrier terminal block;
0.25 ... 2.5 (4) mm² / 22 ... 12 AWG
Terminal block width: 5.2 mm / 0.205 inch

gray	2002-1861	50
------	-----------	----

4-conductor carrier terminal block; with push-button
0.25 ... 2.5 (4) mm² / 22 ... 12 AWG
Terminal block width: 5.2 mm / 0.205 inch

gray	2202-1861	50
------	-----------	----

End and intermediate plate; 1 mm thick

orange	2002-1892	100 (25)
gray	2002-1891	100 (25)

2-conductor carrier terminal block;
0.25 ... 2.5 (4) mm² / 22 ... 12 AWG
Terminal block width: 5.2 mm / 0.205 inch

gray	2002-1961	50
------	-----------	----

2-conductor carrier terminal block; with push-button
0.25 ... 2.5 (4) mm² / 22 ... 12 AWG
Terminal block width: 5.2 mm / 0.205 inch

gray	2202-1961	50
------	-----------	----

End and intermediate plate; 1 mm thick

orange	2002-1992	100 (25)
gray	2002-1991	100 (25)

Push-in type wire jumper; insulated; 1.5 mm² conductor
cross-section; I_N 18 A

L = 60 mm	2009-412	100 (10)
L = 110 mm	2009-414	100 (10)
L = 250 mm	2009-416	100 (10)

Push-in type jumper bar; insulated; I_N 25 A; light gray

2-way	2002-402	25
3-way	2002-403	25
4-way	2002-404	25
5-way	2002-405	25
6-way	2002-406	25
7-way	2002-407	25
8-way	2002-408	25
9-way	2002-409	25
10-way	2002-410	25

Push-in type jumper bar; insulated; I_N 25 A; light gray

1 to 3	2002-433	25
1 to 4	2002-434	25
1 to 5	2002-435	25
1 to 6	2002-436	25
1 to 7	2002-437	25
1 to 8	2002-438	25
1 to 9	2002-439	25
1 to 10	2002-440	25

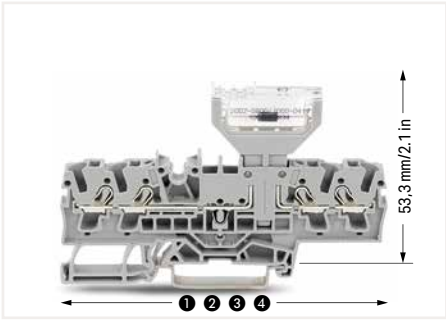

Lengths of carrier terminal blocks with a pluggable diode module:

- 1 66.1 mm / 2.62 inch for 2002-1661
- 2 76.8 mm / 3.02 inch for 2002-1761
- 3 87.5 mm / 3.45 inch for 2002-1861
- 4 72.9 mm / 2.87 inch for 2002-1961

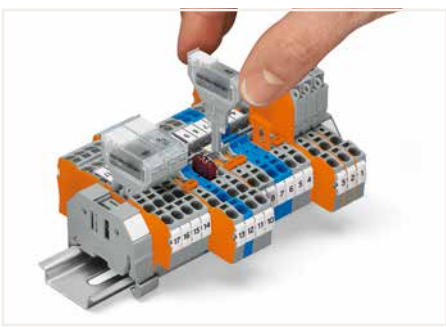

These diode modules are ideal for custom diode circuits (e.g., lamp test and collective fault signal circuits) and offer the following advantages:

- Separation into functional and wiring levels
- Polarized switching direction
- Quick and easy module replacement
- Terminal blocks/modules provide high-density wiring in a width of just 5.2 mm

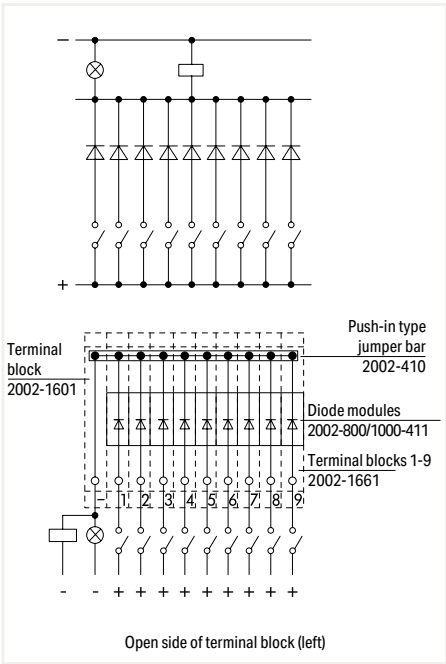

Diode module (2002-800/1000-411)
Diode gate for collective fault indication

Pluggable Diode Module, Empty Component Plug Housing TOPJOB® S on Through Terminal Block 2.5 (4) mm² 2002 Series

Technical Data

U_N 250 V; U_{RM} 1000 V

I_N 0.5 A

Plug width: 10.4 mm / 0.409 inch



2002-880/1000-411

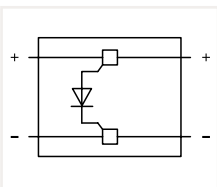

Diode module; with 1N4007 recovery diode; max. operating temperature: 85°C; 10.4 mm wide

Color	Item No.	Pack. Unit
○ gray	2002-880/1000-411	50

Empty component plug housing; type 4; 10.4 mm wide

○ gray	2002-880	50
--------	----------	----

Accessories for Through Terminal Blocks

Appropriate marking systems:
WMB/Marking strips

2-conductor through terminal block;
0.25 ... 2.5 (4) mm² / 22 ... 12 AWG
Terminal block width: 5.2 mm / 0.205 inch

gray	2002-1201	100
------	-----------	-----

2-conductor through terminal block; with push-button
0.25 ... 2.5 (4) mm² / 22 ... 12 AWG
Terminal block width: 5.2 mm / 0.205 inch

gray	2202-1201	100
------	-----------	-----

End and intermediate plate; 0.8 mm thick

orange	2002-1292	100 (25)
gray	2002-1291	100 (25)

3-conductor through terminal block;
0.25 ... 2.5 (4) mm² / 22 ... 12 AWG
Terminal block width: 5.2 mm / 0.205 inch

gray	2002-1301	100
------	-----------	-----

3-conductor through terminal block; with push-button
0.25 ... 2.5 (4) mm² / 22 ... 12 AWG
Terminal block width: 5.2 mm / 0.205 inch

gray	2202-1301	100
------	-----------	-----

End and intermediate plate; 0.8 mm thick

orange	2002-1392	100 (25)
gray	2002-1391	100 (25)

Please observe the application notes:
Jumpers, from page 174
Marking, from page 640

Approvals and corresponding ratings,
visit www.wago.com

Accessories for Through Terminal Blocks

Appropriate marking systems:
WMB/Marking strips

4-conductor through terminal block;
0.25 ... 2.5 (4) mm² / 22 ... 12 AWG
Terminal block width: 5.2 mm / 0.205 inch

gray	2002-1401	100
------	-----------	-----

4-conductor through terminal block; with push-button
0.25 ... 2.5 (4) mm² / 22 ... 12 AWG
Terminal block width: 5.2 mm / 0.205 inch

gray	2202-1401	100
------	-----------	-----

End and intermediate plate; 0.8 mm thick

orange	2002-1492	100 (25)
gray	2002-1491	100 (25)

Insulation stop; 5 pcs/strip; 0.25 ... 0.5 mm²

light gray	2002-171	200 (25)
------------	----------	----------

Insulation stop; 5 pcs/strip; 0.75 ... 1 mm²

dark gray	2002-172	200 (25)
-----------	----------	----------

Protective warning marker; with black high-voltage symbol; for 5 terminal blocks

yellow	2002-115	100 (25)
--------	----------	----------

Push-in type wire jumper; insulated; 1.5 mm² conductor cross-section; I_N 18 A

L = 60 mm	2009-412	100 (10)
L = 110 mm	2009-414	100 (10)
L = 250 mm	2009-416	100 (10)

Push-in type jumper bar; insulated; I_N 25 A; light gray

2-way	2002-402	25
3-way	2002-403	25
4-way	2002-404	25
5-way	2002-405	25
6-way	2002-406	25
7-way	2002-407	25
8-way	2002-408	25
9-way	2002-409	25
10-way	2002-410	25

Push-in type jumper bar; insulated; I_N 25 A; light gray

1 to 3	2002-433	25
1 to 4	2002-434	25
1 to 5	2002-435	25
1 to 6	2002-436	25
1 to 7	2002-437	25
1 to 8	2002-438	25
1 to 9	2002-439	25
1 to 10	2002-440	25

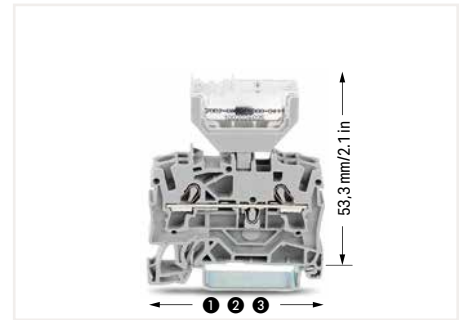

Lengths of through terminal blocks with a pluggable diode module:

- ① 48.5 mm / 1.91 inch for 2002-1201
- ② 59.2 mm / 2.33 inch for 2002-1301
- ③ 69.9 mm / 2.75 inch for 2002-1401

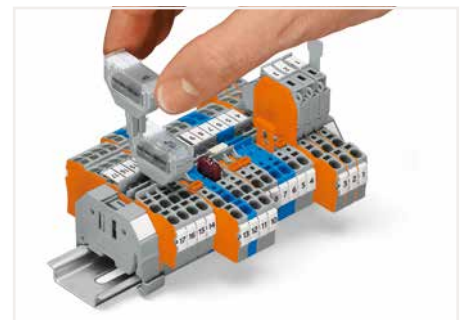

Similar to push-in type jumpers, these diode modules are simply pushed into the current bar's contact slots of two adjacent through terminal blocks, providing the following advantages:

- Compatible with all 2001 to 2006 Series Through Terminal Blocks equipped with jumper slots (note the module's width)
- Easy retrofits for existing systems
- Separation into functional and wiring levels
- Fast replacement of other functional units
- solder-free assembly of diodes, resistors, etc.



Opening the cover via operating tool (2.5 mm blade).

Pluggable LED Module TOPJOB® S on Carrier Terminal Block 2.5 (4) mm² 2002 Series

1

Technical Data	
U_N 250 V; U_{RM} 1000 V	
$I_N \leq 3$ mA	
Plug width: 5.2 mm / 0.205 inch	

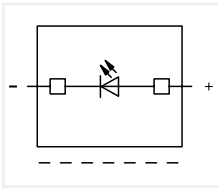

LED module; with red LED; max. operating temperature: 85°C; 5.2 mm wide

	Item No.	Pack. Unit
○ 12 ... 30 V	2002-800/1000-541	100
○ 30 ... 65 V	2002-800/1000-542	100
○ 230 V	2002-800/1000-836	100

Accessories for Carrier Terminal Blocks
Appropriate marking systems:
WMB/Marking strips

2-conductor carrier terminal block;
0.25 ... 2.5 (4) mm² / 22 ... 12 AWG
Terminal block width: 5.2 mm / 0.205 inch

gray	2002-1661	50
------	-----------	----

2-conductor carrier terminal block; with push-button
0.25 ... 2.5 (4) mm² / 22 ... 12 AWG
Terminal block width: 5.2 mm / 0.205 inch

gray	2202-1661	50
------	-----------	----

End and intermediate plate; 1 mm thick

orange	2002-1692	100 (25)
gray	2002-1691	100 (25)

3-conductor carrier terminal block;
0.25 ... 2.5 (4) mm² / 22 ... 12 AWG
Terminal block width: 5.2 mm / 0.205 inch

gray	2002-1761	50
------	-----------	----

3-conductor carrier terminal block; with push-button
0.25 ... 2.5 (4) mm² / 22 ... 12 AWG
Terminal block width: 5.2 mm / 0.205 inch

gray	2202-1761	50
------	-----------	----

End and intermediate plate; 1 mm thick

orange	2002-1792	100 (25)
gray	2002-1791	100 (25)

Please observe the application notes:
Jumpers, from page 174
Marking, from page 640

Approvals and corresponding ratings,
visit www.wago.com

Accessories for Carrier Terminal Blocks

Appropriate marking systems:
WMB/Marking strips

4-conductor carrier terminal block;
0.25 ... 2.5 (4) mm² / 22 ... 12 AWG
Terminal block width: 5.2 mm / 0.205 inch

gray	2002-1861	50
------	-----------	----

4-conductor carrier terminal block; with push-button
0.25 ... 2.5 (4) mm² / 22 ... 12 AWG
Terminal block width: 5.2 mm / 0.205 inch

gray	2202-1861	50
------	-----------	----

End and intermediate plate; 1 mm thick

orange	2002-1892	100 (25)
gray	2002-1891	100 (25)

2-conductor carrier terminal block;
0.25 ... 2.5 (4) mm² / 22 ... 12 AWG
Terminal block width: 5.2 mm / 0.205 inch

gray	2002-1961	50
------	-----------	----

2-conductor carrier terminal block; with push-button
0.25 ... 2.5 (4) mm² / 22 ... 12 AWG
Terminal block width: 5.2 mm / 0.205 inch

gray	2202-1961	50
------	-----------	----

End and intermediate plate; 1 mm thick

orange	2002-1992	100 (25)
gray	2002-1991	100 (25)

Push-in type wire jumper; insulated; 1.5 mm² conductor
cross-section; I_N 18 A

L = 60 mm	2009-412	100 (10)
L = 110 mm	2009-414	100 (10)
L = 250 mm	2009-416	100 (10)

Push-in type jumper bar; insulated; I_N 25 A; light gray

2-way	2002-402	25
3-way	2002-403	25
4-way	2002-404	25
5-way	2002-405	25
6-way	2002-406	25
7-way	2002-407	25
8-way	2002-408	25
9-way	2002-409	25
10-way	2002-410	25

Push-in type jumper bar; insulated; I_N 25 A; light gray

1 to 3	2002-433	25
1 to 4	2002-434	25
1 to 5	2002-435	25
1 to 6	2002-436	25
1 to 7	2002-437	25
1 to 8	2002-438	25
1 to 9	2002-439	25
1 to 10	2002-440	25



Lengths of carrier terminal blocks with a pluggable LED module:

- 1 66.1 mm / 2.62 inch for 2002-1661
- 2 76.8 mm / 3.02 inch for 2002-1761
- 3 87.5 mm / 3.45 inch for 2002-1861
- 4 72.9 mm / 2.87 inch for 2002-1961

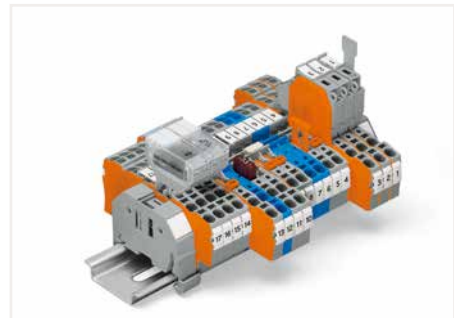

The monitoring of control and operating current circuits with LED modules on rail-mount terminal blocks provides several advantages:

- No additional cost for assembly and wiring
- Separation into functional and wiring levels
- Modules can be replaced quickly by other types of modules
- Polarized switching direction
- Terminal blocks/modules provide high-density wiring in a width of just 5.2 mm

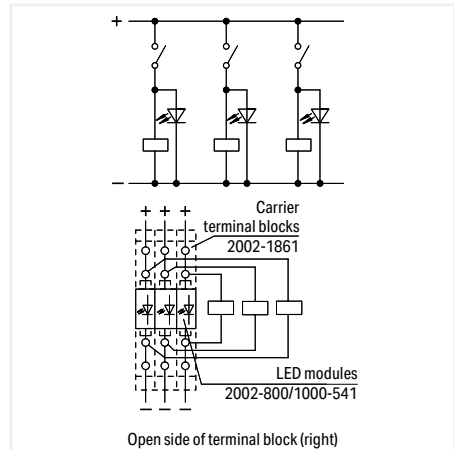

LED module (2002-800/1000-541)
Voltage control assigned to current circuits

Pluggable LED Module TOPJOB® S on Through Terminal Block 2.5 (4) mm² 2002 Series

Technical Data

$I_N \leq 3 \text{ mA}$

Plug width: 10.4 mm / 0.409 inch

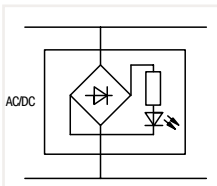

LED module; with red LED; max. operating temperature: 85°C; 10.4 mm wide

	Item No.	Pack. Unit
○ 12 ... 30 V	2002-880/1000-541	50
○ 30 ... 65 V	2002-880/1000-542	50
○ 230 V	2002-880/1000-836	50

Accessories for Through Terminal Blocks

Appropriate marking systems:
WMB/Marking strips

2-conductor through terminal block;
0.25 ... 2.5 (4) mm² / 22 ... 12 AWG
Terminal block width: 5.2 mm / 0.205 inch

gray	2002-1201	100
------	-----------	-----

2-conductor through terminal block; with push-button
0.25 ... 2.5 (4) mm² / 22 ... 12 AWG
Terminal block width: 5.2 mm / 0.205 inch

gray	2202-1201	100
------	-----------	-----

End and intermediate plate; 0.8 mm thick

orange	2002-1292	100 (25)
gray	2002-1291	100 (25)

3-conductor through terminal block;
0.25 ... 2.5 (4) mm² / 22 ... 12 AWG
Terminal block width: 5.2 mm / 0.205 inch

gray	2002-1301	100
------	-----------	-----

3-conductor through terminal block; with push-button
0.25 ... 2.5 (4) mm² / 22 ... 12 AWG
Terminal block width: 5.2 mm / 0.205 inch

gray	2202-1301	100
------	-----------	-----

End and intermediate plate; 0.8 mm thick

orange	2002-1392	100 (25)
gray	2002-1391	100 (25)

Please observe the application notes:
Marking, from page 640

Approvals and corresponding ratings,
visit www.wago.com

Accessories for Through Terminal Blocks

Appropriate marking systems:
WMB/Marking strips

4-conductor through terminal block;
0.25 ... 2.5 (4) mm² / 22 ... 12 AWG
Terminal block width: 5.2 mm / 0.205 inch

gray	2002-1401	100
------	-----------	-----

4-conductor through terminal block; with push-button
0.25 ... 2.5 (4) mm² / 22 ... 12 AWG
Terminal block width: 5.2 mm / 0.205 inch

gray	2202-1401	100
------	-----------	-----

End and intermediate plate; 0.8 mm thick

orange	2002-1492	100 (25)
gray	2002-1491	100 (25)



Dimensions of through terminal blocks with a pluggable LED module:

- ① 48.5 mm / 1.91 inch for 2002-1201
- ② 59.2 mm / 2.33 inch for 2002-1301
- ③ 69.9 mm / 2.75 inch for 2002-1401



Testing via 2-pole test plugs.



Labeling via WMB Multi markers and marking strips

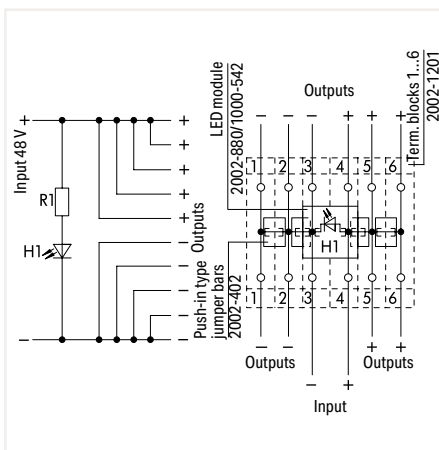

LED module (2002-880/1000-541)
Multiple outputs with indicator lamp

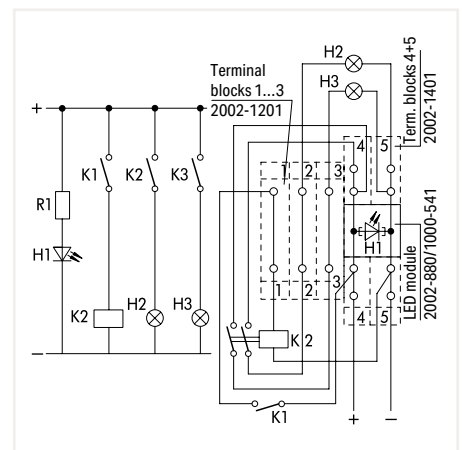

LED module (2002-880/1000-541)
Control unit

Empty Component Plug Housing TOPJOB® S on Carrier Terminal Block 2.5 (4) mm² 2002 Series

1

Technical Data
 Plug width: 5.2 mm / 0.205 inch



Empty component plug housing; type 1; 2-pole; 5.2 mm wide		
Color	Item No.	Pack. Unit
○ gray	2002-800	100

Technical Data
 Plug width: 10.4 mm / 0.409 inch



Empty component plug housing; type 2; 2-pole; 10.4 mm wide		
Color	Item No.	Pack. Unit
○ gray	2002-810	50

Empty component plug housing; type 3; 4-pole; 10.4 mm wide		
Color	Item No.	Pack. Unit
○ gray	2002-820	50

Accessories for Carrier Terminal Blocks

Appropriate marking systems: WMB/Marking strips

2-conductor carrier terminal block; 0.25 ... 2.5 (4) mm² / 22 ... 12 AWG
 Terminal block width: 5.2 mm / 0.205 inch

	gray	2002-1661	50
--	------	-----------	----

4-conductor carrier terminal block; 0.25 ... 2.5 (4) mm² / 22 ... 12 AWG
 Terminal block width: 5.2 mm / 0.205 inch

	gray	2002-1861	50
--	------	-----------	----

2-conductor carrier terminal block; with push-button 0.25 ... 2.5 (4) mm² / 22 ... 12 AWG
 Terminal block width: 5.2 mm / 0.205 inch

	gray	2202-1661	50
--	------	-----------	----

4-conductor carrier terminal block; with push-button 0.25 ... 2.5 (4) mm² / 22 ... 12 AWG
 Terminal block width: 5.2 mm / 0.205 inch

	gray	2202-1861	50
--	------	-----------	----

End and intermediate plate; 1 mm thick			
	orange	2002-1692	100 (25)
	gray	2002-1691	100 (25)

End and intermediate plate; 1 mm thick			
	orange	2002-1892	100 (25)
	gray	2002-1891	100 (25)

3-conductor carrier terminal block; 0.25 ... 2.5 (4) mm² / 22 ... 12 AWG
 Terminal block width: 5.2 mm / 0.205 inch

	gray	2002-1761	50
--	------	-----------	----

2-conductor carrier terminal block; 0.25 ... 2.5 (4) mm² / 22 ... 12 AWG
 Terminal block width: 5.2 mm / 0.205 inch

	gray	2002-1961	50
--	------	-----------	----

3-conductor carrier terminal block; with push-button 0.25 ... 2.5 (4) mm² / 22 ... 12 AWG
 Terminal block width: 5.2 mm / 0.205 inch

	gray	2202-1761	50
--	------	-----------	----

2-conductor carrier terminal block; with push-button 0.25 ... 2.5 (4) mm² / 22 ... 12 AWG
 Terminal block width: 5.2 mm / 0.205 inch

	gray	2202-1961	50
--	------	-----------	----

End and intermediate plate; 1 mm thick			
	orange	2002-1792	100 (25)
	gray	2002-1791	100 (25)

End and intermediate plate; 1 mm thick			
	orange	2002-1992	100 (25)
	gray	2002-1991	100 (25)

Protective warning marker; with black high-voltage symbol; for 5 terminal blocks			
	yellow	2002-115	100 (25)

Multi-purpose operating tool; for component plugs			
		2002-116	5

Push-in type wire jumper; insulated; 1.5 mm ² conductor cross-section; I _N 18 A			
	L = 60 mm	2009-412	100 (10)
	L = 110 mm	2009-414	100 (10)
	L = 250 mm	2009-416	100 (10)

Please observe the application notes: Jumpers, from page 174
 Marking, from page 640

Approvals and corresponding ratings, visit www.wago.com

Accessories for Carrier Terminal Blocks

Appropriate marking systems: WMB/WMB Inline/Marking strips

Double-deck carrier terminal block; 0.25 ... 2.5 (4) mm² / 22 ... 12 AWG
 Terminal block width: 5.2 mm / 0.205 inch

	L/L	2002-2961	50
--	-----	-----------	----

Double-deck carrier terminal block; 0.25 ... 2.5 (4) mm² / 22 ... 12 AWG
 Terminal block width: 5.2 mm / 0.205 inch

	L/N	2002-2963	50
--	-----	-----------	----

End and intermediate plate; 1 mm thick

	orange	2002-2992	100 (25)
	gray	2002-2991	100 (25)

Push-in type jumper bar; insulated; I_N 25 A; light gray

	2-way	2002-402	25
	3-way	2002-403	25
	4-way	2002-404	25
	5-way	2002-405	25
	6-way	2002-406	25
	7-way	2002-407	25
	8-way	2002-408	25
	9-way	2002-409	25
	10-way	2002-410	25

Push-in type jumper bar; insulated; I_N 25 A; light gray

	1 to 3	2002-433	25
	1 to 4	2002-434	25
	1 to 5	2002-435	25
	1 to 6	2002-436	25
	1 to 7	2002-437	25
	1 to 8	2002-438	25
	1 to 9	2002-439	25
	1 to 10	2002-440	25

Staggered jumper; insulated; I_N 25 A; light gray

	2-way	2002-472	25
	3-way	2002-473	25
	4-way	2002-474	25
	5-way	2002-475	25
	6-way	2002-476	25
	7-way	2002-477	25
	8-way	2002-478	25
	9-way	2002-479	25
	10-way	2002-480	25
	11-way	2002-481	25
	12-way	2002-482	25

WMB marking card; white; 10 strips with 10 markers/card; 5 ... 5.2 mm stretchable

	plain	793-5501	5
--	-------	----------	---

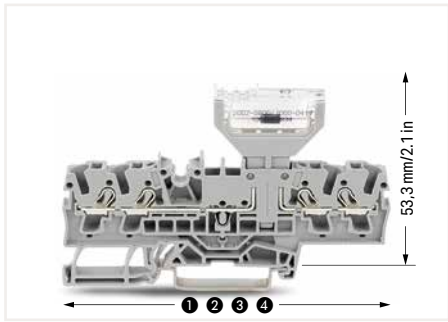

Lengths of carrier terminal blocks with a pluggable diode module:

- ❶ 66.1 mm / 2.62 inch for 2002-1661
- ❷ 76.8 mm / 3.02 inch for 2002-1761
- ❸ 87.5 mm / 3.45 inch for 2002-1861
- ❹ 72.9 mm / 2.87 inch for 2002-1961



Cutting component to the proper length.



Pressing component into plug contact via operating tool.

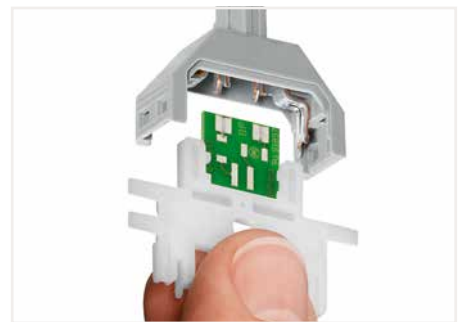

Pushing PCB into plug contact via operating tool.

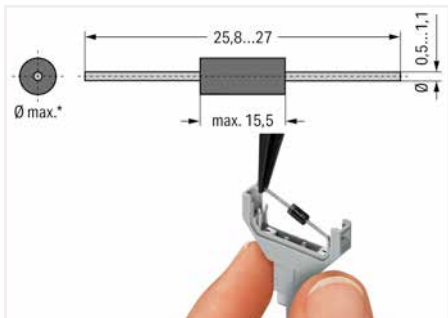

*max. 3.4 mm Ø at 5.2 mm module width and
 *max. 5.4 mm Ø at 10.4 mm module width
 Notice: Reconnection only possible with similar or larger wire diameter.



Component plugs for building custom circuits solder-free assembly of diodes, resistors, etc. (Illustration shows a 1N4007 diode)

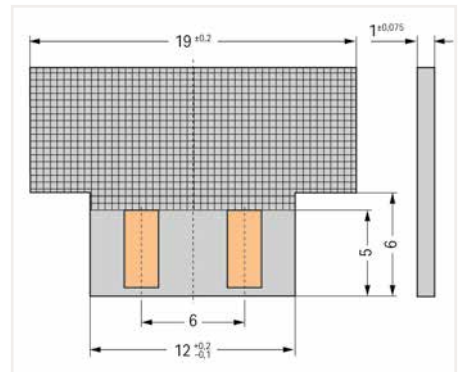

Dimensions of self-assembled PCBs:
 Module height: 2 mm at 5.2 mm module width and module height: 3.3 mm at 10.4 mm module width



When closing the cover, please insert cover as shown in the illustration.



Opening the cover via operating tool (2.5 mm blade).



Opening the cover via multi-purpose operating tool for component plugs.

Component Plug TOPJOB® S on Carrier Terminal Blocks 2.5 (4) mm² 2042 Series

1



Component plug; 4-pole; transparent housing; with fiber optics; 10.3 mm wide		
Item No.	Pack. Unit	
2042-321	5	

Component plug; 6-pole; transparent housing; with fiber optics; 15.5 mm wide		
Item No.	Pack. Unit	
2042-331	5	

Component plug; 8-pole; transparent housing; with fiber optics; 20.7 mm wide		
Item No.	Pack. Unit	
2042-341	5	

Component plug; 10-pole; transparent housing; with fiber optics; 25.9 mm wide		
Item No.	Pack. Unit	
2042-351	5	

Accessories for Carrier Terminal Blocks
Appropriate marking systems: WMB/Marking strips

2-conductor carrier terminal block; 0.25 ... 2.5 (4) mm ² / 22 ... 12 AWG Terminal block width: 5.2 mm / 0.205 inch			
	gray	2002-1661	50

4-conductor carrier terminal block; 0.25 ... 2.5 (4) mm ² / 22 ... 12 AWG Terminal block width: 5.2 mm / 0.205 inch			
	gray	2002-1861	50

2-conductor carrier terminal block; with push-button 0.25 ... 2.5 (4) mm ² / 22 ... 12 AWG Terminal block width: 5.2 mm / 0.205 inch			
	gray	2202-1661	50

4-conductor carrier terminal block; with push-button 0.25 ... 2.5 (4) mm ² / 22 ... 12 AWG Terminal block width: 5.2 mm / 0.205 inch			
	gray	2202-1861	50

End and intermediate plate; 1 mm thick			
	orange	2002-1692	100 (25)
	gray	2002-1691	100 (25)

End and intermediate plate; 1 mm thick			
	orange	2002-1892	100 (25)
	gray	2002-1891	100 (25)

3-conductor carrier terminal block; 0.25 ... 2.5 (4) mm ² / 22 ... 12 AWG Terminal block width: 5.2 mm / 0.205 inch			
	gray	2002-1761	50

2-conductor carrier terminal block; 0.25 ... 2.5 (4) mm ² / 22 ... 12 AWG Terminal block width: 5.2 mm / 0.205 inch			
	gray	2002-1961	50

3-conductor carrier terminal block; with push-button 0.25 ... 2.5 (4) mm ² / 22 ... 12 AWG Terminal block width: 5.2 mm / 0.205 inch			
	gray	2202-1761	50

2-conductor carrier terminal block; with push-button 0.25 ... 2.5 (4) mm ² / 22 ... 12 AWG Terminal block width: 5.2 mm / 0.205 inch			
	gray	2202-1961	50

End and intermediate plate; 1 mm thick			
	orange	2002-1792	100 (25)
	gray	2002-1791	100 (25)

End and intermediate plate; 1 mm thick			
	orange	2002-1992	100 (25)
	gray	2002-1991	100 (25)

Protective warning marker; with black high-voltage symbol; for 5 terminal blocks			
	yellow	2002-115	100 (25)

WMB marking card; white; 10 strips with 10 markers/card; 5 ... 5.2 mm stretchable			
	plain	793-5501	5

Push-in type wire jumper; insulated; 1.5 mm ² conductor cross-section; I _N 18 A			
	L = 60 mm	2009-412	100 (10)
	L = 110 mm	2009-414	100 (10)
	L = 250 mm	2009-416	100 (10)

Length for 2002-1661 – 66.5 mm / 2.62 inch 2-conductor carrier terminal block	
Length for 2002-1761 – 76.8 mm / 3.02 inch 3-conductor carrier terminal block	
Length for 2002-1861 – 87.5 mm / 3.45 inch 4-conductor carrier terminal block	
Length for 2002-1961 – 72.9 mm / 2.87 inch 2-conductor carrier terminal block; with additional jumper slot	
Please observe the application notes: Jumpers, from page 174 Marking, from page 640	
Approvals and corresponding ratings, visit www.wago.com	

Accessories for Carrier Terminal Blocks
Appropriate marking systems:
WMB/WMB Inline/Marking strips

Double-deck carrier terminal block; 0.25 ... 2.5 (4) mm ² / 22 ... 12 AWG Terminal block width: 5.2 mm / 0.205 inch			
	L/L	2002-2961	50

Double-deck carrier terminal block; 0.25 ... 2.5 (4) mm ² / 22 ... 12 AWG Terminal block width: 5.2 mm / 0.205 inch			
	L/N	2002-2963	50

End and intermediate plate; 1 mm thick			
	orange	2002-2992	100 (25)
	gray	2002-2991	100 (25)

Push-in type jumper bar; insulated; I _N 25 A; light gray			
	2-way	2002-402	25
	3-way	2002-403	25
	4-way	2002-404	25
	5-way	2002-405	25
	6-way	2002-406	25
	7-way	2002-407	25
	8-way	2002-408	25
	9-way	2002-409	25
	10-way	2002-410	25

Push-in type jumper bar; insulated; I _N 25 A; light gray			
	1 to 3	2002-433	25
	1 to 4	2002-434	25
	1 to 5	2002-435	25
	1 to 6	2002-436	25
	1 to 7	2002-437	25
	1 to 8	2002-438	25
	1 to 9	2002-439	25
	1 to 10	2002-440	25

Staggered jumper; insulated; I _N 25 A; light gray			
	2-way	2002-472	25
	3-way	2002-473	25
	4-way	2002-474	25
	5-way	2002-475	25
	6-way	2002-476	25
	7-way	2002-477	25
	8-way	2002-478	25
	9-way	2002-479	25
	10-way	2002-480	25
	11-way	2002-481	25
	12-way	2002-482	25

Double-Deck Disconnect/Test Terminal Block TOPJOB® S

2.5 (4) mm²; 2002 Series

1

Technical Data	
0.25 ... 2.5 (4) mm ² ①	22 ... 12 AWG
400 V/6 kV/3 ②	300 V, 15 A ③
I _N 16 A	300 V, 15 A ④
Terminal block width: 5.2 mm / 0.205 inch	
 10 ... 12 mm / 0.39 ... 0.47 inch	

Technical Data	
0.25 ... 2.5 (4) mm ² ①	22 ... 12 AWG
400 V/6 kV/3 ②	300 V, 15 A ③
I _N 16 A	300 V, 15 A ④
Terminal block width: 5.2 mm / 0.205 inch	
 10 ... 12 mm / 0.39 ... 0.47 inch	

Technical Data	
0.25 ... 2.5 (4) mm ² ①	22 ... 12 AWG
400 V/6 kV/3 ②	300 V, 15 A ③
I _N 16 A	300 V, 15 A ④
Terminal block width: 5.2 mm / 0.205 inch	
 10 ... 12 mm / 0.39 ... 0.47 inch	

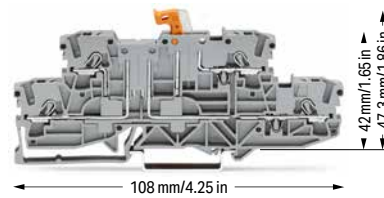
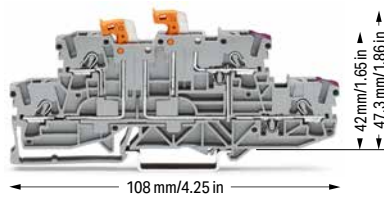
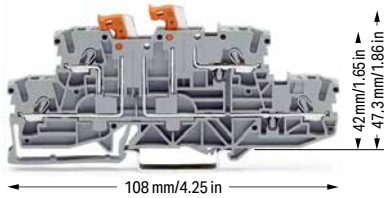

Double-deck, double-disconnect terminal block; with 2 pivoting knife disconnects; gray

Double-deck, double-disconnect terminal block; with two pivoting knife disconnects; lower and upper decks internally commoned on right side, violet conductor entry; gray

Double-deck disconnect terminal block; with pivoting knife disconnect; same profile as double-deck, double-disconnect terminal block; gray

	Item No.	Pack. Unit
○ L/L ⑤	2002-2951 ④	50
○ N/L ⑤	2002-2952 ④	50

	Item No.	Pack. Unit
○ L/L ⑤	2002-2958 ④	50

	Item No.	Pack. Unit
○ L/L ⑤	2002-2971 ④	50
○ N/L ⑤	2002-2972 ④	50

Double-deck, double-disconnect terminal block; with 2 pivoting knife disconnects; blue

Double-deck, double-disconnect terminal block; with two pivoting knife disconnects; lower and upper decks internally commoned on right side, violet conductor entry; blue

Double-deck disconnect terminal block; with pivoting knife disconnect; same profile as double-deck, double-disconnect terminal block; blue



● N/N ⑤	2002-2954 ③ ④	50
---------	---------------	----

● N/N ⑤	2002-2959 ③ ④	50
---------	---------------	----

● N/N ⑤	2002-2974 ③ ④	50
---------	---------------	----

Accessories; 2002 Series

Appropriate marking systems: WMB/WMB Inline/Marking strips

End and intermediate plate; 1 mm thick			
	orange	2002-2992	100 (25)
	gray	2002-2991	100 (25)

Ex e/Ex i separator; orange; 3 mm thick			
	125.5 mm	209-192	50 (25)

Insulation stop; 5 pcs/strip; 0.25 ... 0.5 mm ²			
	light gray	2002-171	200 (25)

Insulation stop; 5 pcs/strip; 0.75 ... 1 mm ²			
	dark gray	2002-172	200 (25)

Protective warning marker; with black high-voltage symbol; for 5 terminal blocks			
	yellow	2002-115	100 (25)

Push-in type jumper bar; insulated; I _N 25 A; light gray			
	2-way	2002-402	25
	3-way	2002-403	25
	4-way	2002-404	25
	5-way	2002-405	25
	6-way	2002-406	25
	7-way	2002-407	25
	8-way	2002-408	25
	9-way	2002-409	25
	10-way	2002-410	25

Push-in type jumper bar; insulated; I _N 25 A; light gray			
	1 to 3	2002-433	25
	1 to 4	2002-434	25
	1 to 5	2002-435	25
	1 to 6	2002-436	25
	1 to 7	2002-437	25
	1 to 8	2002-438	25
	1 to 9	2002-439	25
	1 to 10	2002-440	25

Delta jumper; insulated; I _N = I _N terminal block; light gray			
	1-2 3-4 5-6	2002-406/020-000	25

Star point jumper; insulated; I _N = I _N terminal block; light gray			
	1-3-5	2002-405/011-000	25

Staggered jumper; insulated; I _N 25 A; light gray			
	2-way	2002-472	25
	3-way	2002-473	25
	4-way	2002-474	25
	5-way	2002-475	25
	6-way	2002-476	25
	7-way	2002-477	25
	8-way	2002-478	25
	9-way	2002-479	25
	10-way	2002-480	25
	11-way	2002-481	25
	12-way	2002-482	25

Push-in type wire jumper; insulated; 1.5 mm ² conductor cross-section; I _N 18 A			
	L = 60 mm	2009-412	100 (10)
	L = 110 mm	2009-414	100 (10)
	L = 250 mm	2009-416	100 (10)

Adjacent jumper for continuous commoning; insulated; I _N 25 A, light gray			
	2-way	2002-400	25

Adjacent jumper for continuous commoning; insulated; I _N 25 A; 1 to 3			
	light gray	2002-423	25
	red	2002-423/000-005	25
	blue	2002-423/000-006	25

Modular connector; snaps together; for jumper contact slot			
	gray	2002-511	100 (25)

Spacer module; snaps together; bridges commoned terminal blocks			
	gray	2002-549	100 (25)

Test plug adapter; for 4 mm Ø test plug			
	gray	2009-174	100 (25)

Testing tap; for max. 2.5 mm ²			
	gray	2009-182	100 (25)

Test plug; with 500 mm cable; 2 mm Ø; max. 42 V			
	red	210-136	50 (1)

- ❶ Conductor range: 0.25 ... 4 mm² "s+f-st";
Push-in termination: 1 ... 4 mm² "s" and 1 ... 2.5 mm² "insulated ferrules, 12 mm"
Depending on the conductor characteristic, a conductor with a smaller cross section can also be inserted via push-in termination.
- ❷ 400 V = rated voltage
6 kV = rated impulse voltage
3 = pollution degree
(see Section 15)
- ❸ Terminal blocks with a blue insulated housing are suitable for Ex i applications.
- ❹ Terminal blocks with an Ex mark are suitable for Ex e II applications.
440 V; 14 A
(see Section 15)

Please observe the application notes:
Jumpers, from page 174
Testing accessories, from page 169
Marking, from page 640

Approvals and corresponding ratings,
visit www.wago.com

Accessories; 2002 Series

Appropriate marking systems:
WMB/WMB Inline/Marking strips

Marking strip; plain; 11 mm wide; 50 m reel

	white	2009-110	1
--	-------	----------	---

WMB Inline, plain; 1,500 WMB markers (5 mm)/reel; 5 ... 5.2 mm stretchable

	white	2009-115	1
---	-------	----------	---

WMB marking card; white; 10 strips with 10 markers/card; 5 ... 5.2 mm stretchable

	plain	793-5501	5
---	-------	----------	---

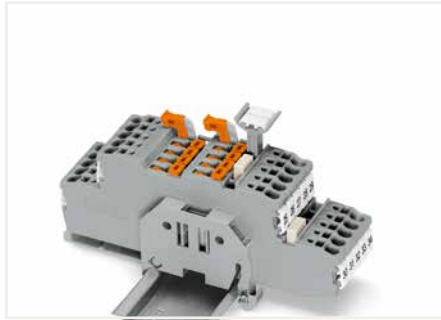

Double-deck, double-disconnect terminal blocks (2002-2951) with group marker carrier accommodated in jumper contact slot



Double-deck, double-disconnect terminal block (2002-2951) with group marker carrier (2002-160) accommodated in jumper contact slot

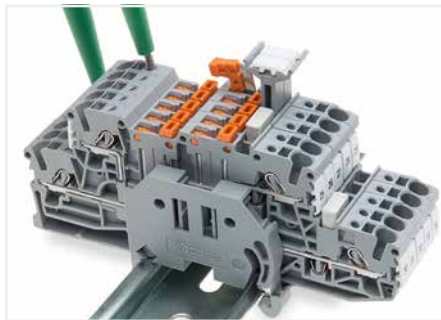

Testing with voltage tester.

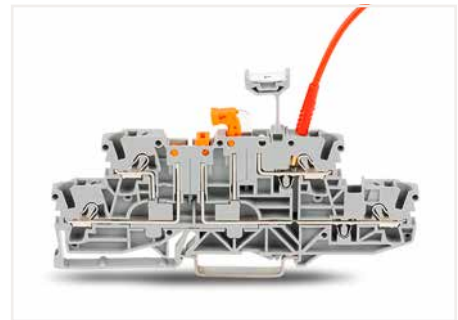

Double-deck, double-disconnect terminal block (2002-2951) with group marker carrier (2002-160) accommodated in a jumper contact slot and test plug (210-136)

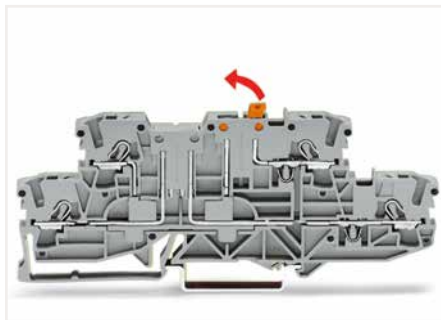

Double-deck disconnect terminal block (2002-2971)
Opening a knife disconnect.

Double-Deck Carrier Terminal Block TOPJOB® S

2.5 (4) mm²; 2002 Series

1

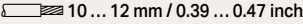
Technical Data	
0.25 ... 2.5 (4) mm ² ①	22 ... 12 AWG
400 V/6 kV/3 ②	300 V, 15 A ③
I _N 16 A	300 V, 15 A ④
Terminal block width: 5.2 mm / 0.205 inch	
 10 ... 12 mm / 0.39 ... 0.47 inch	

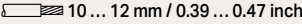
Technical Data	
0.25 ... 2.5 (4) mm ² ①	22 ... 12 AWG
400 V/6 kV/3 ②	300 V, 15 A ③
I _N 16 A	300 V, 15 A ④
Terminal block width: 5.2 mm / 0.205 inch	
 10 ... 12 mm / 0.39 ... 0.47 inch	

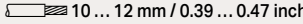
Technical Data	
0.25 ... 2.5 (4) mm ² ①	22 ... 12 AWG
400 V/6 kV/3 ②	300 V, 15 A ③
I _N 16 A	300 V, 15 A ④
Terminal block width: 5.2 mm / 0.205 inch	
 10 ... 12 mm / 0.39 ... 0.47 inch	

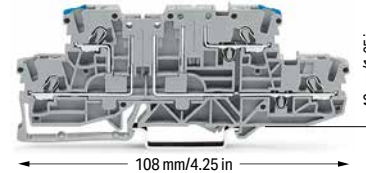
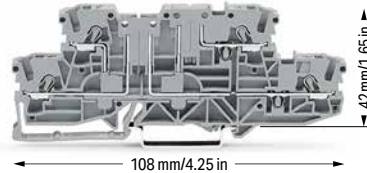
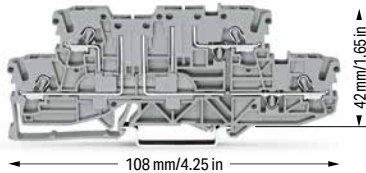

Double-deck carrier terminal block; gray		
	Bestellnr.	VPE
○ L/L ⑤	2002-2941 ⑥	50

Double-deck carrier terminal block; gray		
	Bestellnr.	VPE
○ L/L ⑤	2002-2961 ⑥	50

Double-deck carrier terminal block; gray		
	Bestellnr.	VPE
○ L/N ⑤	2002-2963 ⑥	50

Accessories; 2002 Series

Appropriate marking systems: WMB/WMB Inline/Marking strips

End and intermediate plate; 1 mm thick			
	orange	2002-2992	100 (25)
	gray	2002-2991	100 (25)

Ex e/Ex i separator; orange; 3 mm thick			
	125.5 mm	209-192	50 (25)

Insulation stop; 5 pcs/strip; 0.25 ... 0.5 mm ²			
	light gray	2002-171	200 (25)

Insulation stop; 5 pcs/strip; 0.75 ... 1 mm ²			
	dark gray	2002-172	200 (25)

Protective warning marker; with black high-voltage symbol; for 5 terminal blocks			
	yellow	2002-115	100 (25)

Push-in type jumper bar; insulated; I _N 25 A; light gray			
	2-way	2002-402	25
	3-way	2002-403	25
	4-way	2002-404	25
	5-way	2002-405	25
	6-way	2002-406	25
	7-way	2002-407	25
	8-way	2002-408	25
	9-way	2002-409	25
	10-way	2002-410	25

Push-in type jumper bar; insulated; I _N 25 A; light gray			
	1 to 3	2002-433	25
	1 to 4	2002-434	25
	1 to 5	2002-435	25
	1 to 6	2002-436	25
	1 to 7	2002-437	25
	1 to 8	2002-438	25
	1 to 9	2002-439	25
	1 to 10	2002-440	25

Delta jumper; insulated; I _N = I _N terminal block; light gray			
	1-2 3-4 5-6	2002-406/020-000	25

Star point jumper; insulated; I _N = I _N terminal block; light gray			
	1-3-5	2002-405/011-000	25

Staggered jumper; insulated; I _N 25 A; light gray			
	2-way	2002-472	25
	3-way	2002-473	25
	4-way	2002-474	25
	5-way	2002-475	25
	6-way	2002-476	25
	7-way	2002-477	25
	8-way	2002-478	25
	9-way	2002-479	25
	10-way	2002-480	25
	11-way	2002-481	25
	12-way	2002-482	25

Adjacent jumper for continuous commoning; insulated; I _N 25 A, light gray			
	2-way	2002-400	25

Adjacent jumper for continuous commoning; insulated; I _N 25 A; 1 to 3			
	light gray	2002-423	25
	red	2002-423/000-005	25
	blue	2002-423/000-006	25

Push-in type wire jumper; insulated; 1.5 mm ² conductor cross-section; I _N 18 A			
	L = 60 mm	2009-412	100 (10)
	L = 110 mm	2009-414	100 (10)
	L = 250 mm	2009-416	100 (10)

Disconnect plug for carrier terminal blocks; suitable when using a carrier terminal block as disconnect terminal block			
	orange	2002-401	100 (25)

Modular connector; snaps together; for jumper contact slot			
	gray	2002-511	100 (25)

Spacer module; snaps together; bridges commoned terminal blocks			
	gray	2002-549	100 (25)

Test plug adapter; for 4 mm Ø test plug			
	gray	2009-174	100 (25)

Testing tap; for max. 2.5 mm ²			
	gray	2009-182	100 (25)

Test plug; with 500 mm cable; 2 mm Ø; max. 42 V			
	red	210-136	50 (1)

Marking strip; plain; 11 mm wide; 50 m reel			
	white	2009-110	1

WMB Inline, plain; 1,500 WMB markers (5 mm)/reel; 5 ... 5.2 mm stretchable			
	white	2009-115	1

WMB marking card; white; 10 strips with 10 markers/card; 5 ... 5.2 mm stretchable			
	plain	793-5501	5

① Conductor range: 0.25 ... 4 mm² "s+f-st";
 Push-in termination: 1 ... 4 mm² "s" and 1 ... 2.5 mm²
 "insulated ferrules, 12 mm"
 Depending on the conductor characteristic, a conductor
 with a smaller cross section can also be inserted
 via push-in termination.

② 400 V = rated voltage
 6 kV = rated impulse voltage
 3 = pollution degree
 (see Section 15)

③ Terminal blocks with an Ex mark are suitable for Ex e II
 applications.
 440 V; 14 A

Please observe the application notes:
 Jumpers, from page 174
 Testing accessories, from page 169
 Marking, from page 640

Approvals and corresponding ratings,
 visit www.wago.com

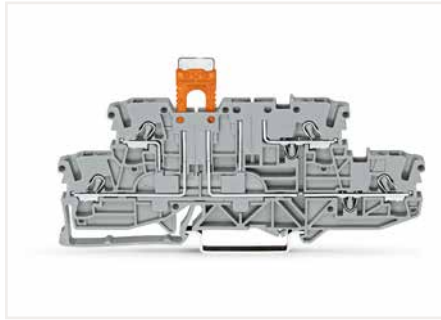

Carrier terminal block (2002-2941) with disconnect plug
 (2002-401) in parked position

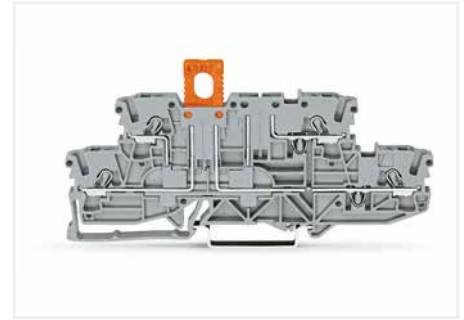

Carrier terminal block (2002-2941) with disconnect plug
 (2002-401) in operating position

Double-Deck Diode Terminal Block and LED Terminal Block TOPJOB® S

2.5 (4) mm²; 2002 Series

1

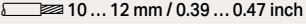
Technical Data	
0.25 ... 2.5 (4) mm ² ①	22 ... 12 AWG
U _N 250 V; U _{RM} 1000 V	
1N4007 - 0.5 A continuous current	
Terminal block width: 5.2 mm / 0.205 inch	
 10 ... 12 mm / 0.39 ... 0.47 inch	

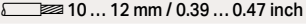
Technical Data	
0.25 ... 2.5 (4) mm ² ①	22 ... 12 AWG
U _N 250 V; U _{RM} 1000 V	
1N4007 - 0.5 A continuous current	
Terminal block width: 5.2 mm / 0.205 inch	
 10 ... 12 mm / 0.39 ... 0.47 inch	

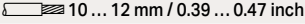
Technical Data	
0.25 ... 2.5 (4) mm ² ①	22 ... 12 AWG
24 VDC	
I _F 0.025 A max.	
Terminal block width: 5.2 mm / 0.205 inch	
 10 ... 12 mm / 0.39 ... 0.47 inch	

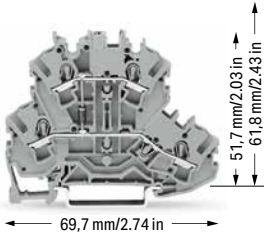

2002-2211/1000-410 2002-2211/1000-411

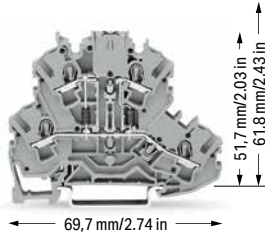

2002-2213/1000-487 2002-2213/1000-488

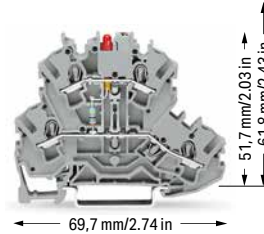

2002-2221/1000-434 2002-2221/1000-413

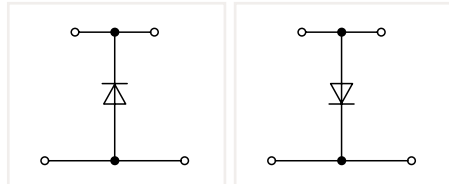

Double-deck diode terminal block; with 1N4007 diode; gray

	Item No.	Pack. Unit
○ anode bottom	2002-2211/1000-410	50
○ anode top	2002-2211/1000-411	50

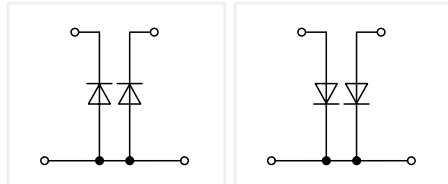

Double-deck diode terminal block; with two 1N4007 diodes; gray

	Item No.	Pack. Unit
○ anodes bottom	2002-2213/1000-487	50
○ anodes top	2002-2213/1000-488	50

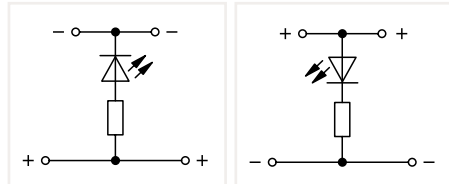

Double-deck LED terminal block; with red LED; gray

	Item No.	Pack. Unit
○ anode bottom	2002-2221/1000-434	50
○ anode top	2002-2221/1000-413	50

Other terminal blocks with the same profile:
Through **2002-2201** Page 76

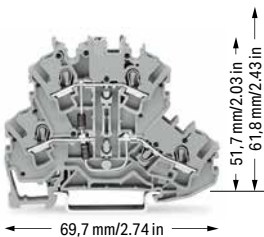

2002-2214/1000-492 2002-2214/1000-491

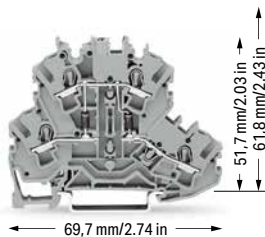

2002-2214/1000-489 2002-2214/1000-490

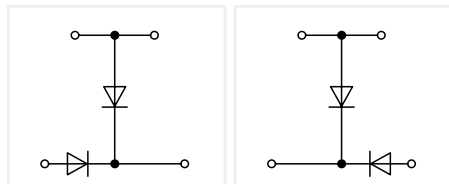

Double-deck diode terminal block; with two 1N4007 diodes; gray

	Item No.	Pack. Unit
○ anode top, anode left	2002-2214/1000-492	50
○ anode top, anode right	2002-2214/1000-491	50

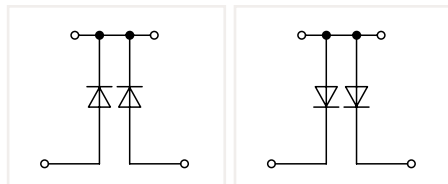

Double-deck diode terminal block; with two 1N4007 diodes; gray

	Item No.	Pack. Unit
○ anodes bottom	2002-2214/1000-489	50
○ anodes top	2002-2214/1000-490	50

Double-deck diode terminal block; with two 1N4007 diodes; gray

	Item No.	Pack. Unit
○ anode top, anode bottom	2002-2214/1000-980	50

Double-Deck Diode Terminal Blocks and LED Terminal Blocks TOPJOB® S Circuit Configuration Examples

❶ Conductor range: 0.25 ... 4 mm² "s+f-st";
Push-in termination: 1 ... 4 mm² "s" and 1 ... 2.5 mm²
"insulated ferrules, 12 mm"
Depending on the conductor characteristic, a conductor with a smaller cross section can also be inserted via push-in termination.

Approvals and corresponding ratings, visit www.wago.com

Accessories; 2002 Series
Appropriate marking systems:
WMB/WMB Inline/Marking strips

End and intermediate plate; 0.8 mm thick

	orange	2002-2292	100 (25)
	gray	2002-2291	100 (25)

Insulation stop; 5 pcs/strip; 0.25 ... 0.5 mm²

	light gray	2002-171	200 (25)
---	------------	----------	----------

Insulation stop; 5 pcs/strip; 0.75 ... 1 mm²

	dark gray	2002-172	200 (25)
---	-----------	----------	----------

Push-in type jumper bar; insulated; I_N 25 A; light gray

	2-way	2002-402	25
	3-way	2002-403	25
	4-way	2002-404	25
	5-way	2002-405	25
	6-way	2002-406	25
	7-way	2002-407	25
	8-way	2002-408	25
	9-way	2002-409	25
	10-way	2002-410	25

Push-in type jumper bar; insulated; I_N 25 A; light gray

	1 to 3	2002-433	25
	1 to 4	2002-434	25
	1 to 5	2002-435	25
	1 to 6	2002-436	25
	1 to 7	2002-437	25
	1 to 8	2002-438	25
	1 to 9	2002-439	25
	1 to 10	2002-440	25

Double-deck marker carrier; pivoting

	gray	2002-121	50 (25)
---	------	----------	---------

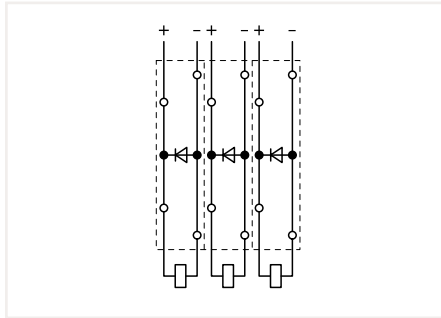

Open diode gates can be created using the following terminal blocks:
2002-2211/1000-410 or 2002-2211/1000-411

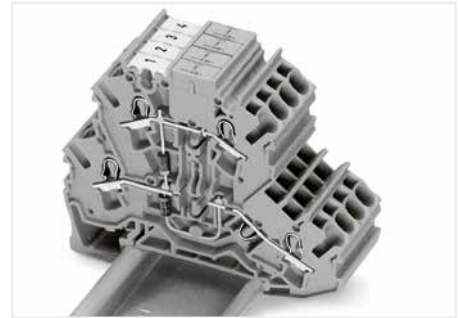

Double-deck diode terminal blocks were specifically developed for custom diode circuits, such as lamp test and collective fault signal circuits. These terminal blocks provide high-density wiring in a width of just 5.2 mm. Push-in type jumper bars provide additional options for custom circuit design.

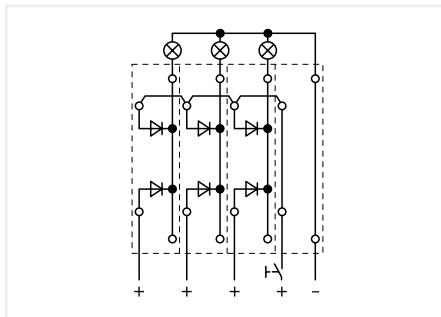

Polarized diode gates with a common cathode can be created using the following terminal blocks:
2002-2213/1000-487 or 2002-2213/1000-488

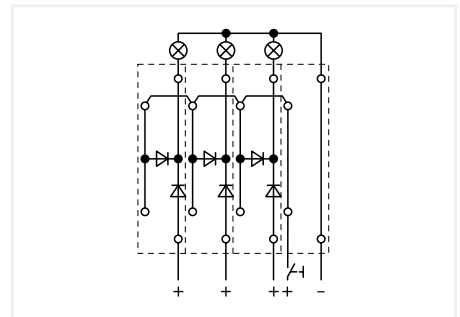

Lamp test circuits can be created using the following terminal blocks:
2002-2214/1000-492 or 2002-2214/1000-491

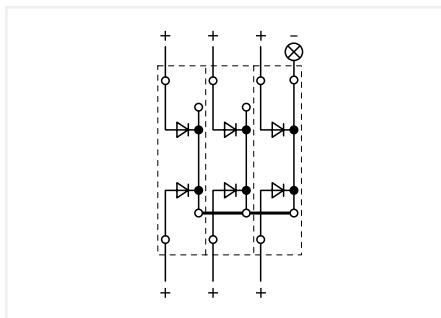

Polarized diode gates with a common cathode can be created using the following terminal blocks:
2002-2214/1000-489 or 2002-2214/1000-490

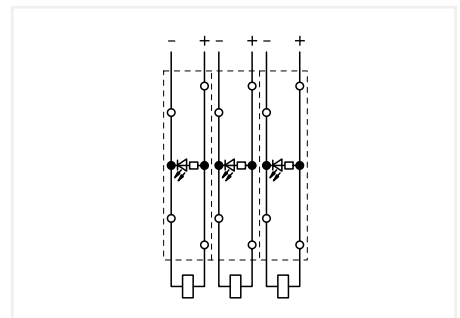

Circuit-related voltage indications can be created using the following terminal blocks:
2002-2221/1000-434 or 2002-2221/1000-413

Triple-Deck Diode Terminal Block, Triple-Deck LED Terminal Block TOPJOB® S

2.5 (4) mm²; 2002 Series

1

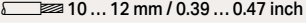
Technical Data	
0.25 ... 2.5 (4) mm ² ①	22 ... 12 AWG
U _N 250 V; U _{RM} 1000 V	
1N4007 - 0.5 A continuous current	
Terminal block width: 5.2 mm / 0.205 inch	
 10 ... 12 mm / 0.39 ... 0.47 inch	

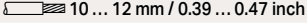
Technical Data	
0.25 ... 2.5 (4) mm ² ①	22 ... 12 AWG
U _N 250 V; U _{RM} 1000 V	
1N4007 - 0.5 A continuous current	
Terminal block width: 5.2 mm / 0.205 inch	
 10 ... 12 mm / 0.39 ... 0.47 inch	

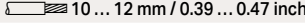
Technical Data	
0.25 ... 2.5 (4) mm ² ①	22 ... 12 AWG
24 VDC	
I _F 0.025 A max.	
Terminal block width: 5.2 mm / 0.205 inch	
 10 ... 12 mm / 0.39 ... 0.47 inch	

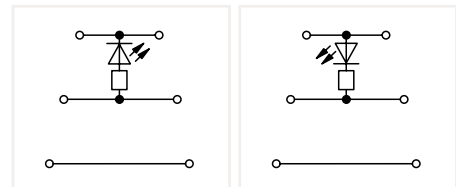
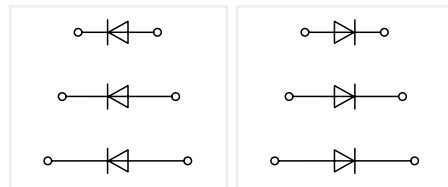
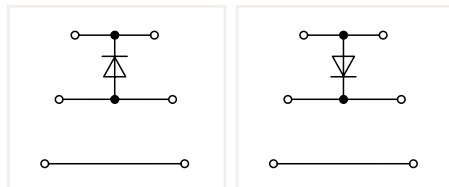
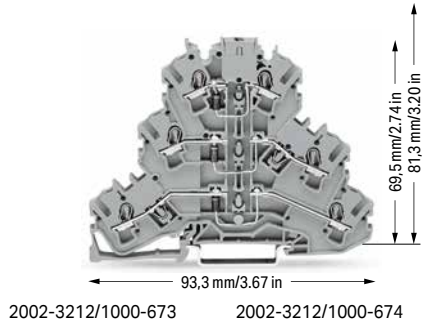
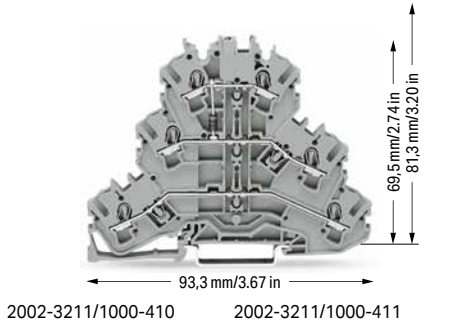

Triple-deck diode terminal block; with 1N4007 diode; gray

	Item No.	Pack. Unit
○ anode bottom	2002-3211/1000-410	50
○ anode top	2002-3211/1000-411	50

Triple-deck diode terminal block; with three 1N4007 diodes; gray

	Item No.	Pack. Unit
○ anodes right	2002-3212/1000-673	50
○ anodes left	2002-3212/1000-674	50

Triple-deck LED terminal block; with red LED; gray

	Item No.	Pack. Unit
○ anode bottom	2002-3221/1000-434	50
○ anode top	2002-3221/1000-413	50

Other terminal blocks with the same profile:
Through 2002-3201 Page 88

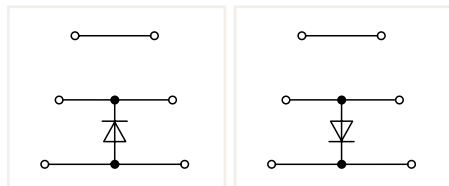
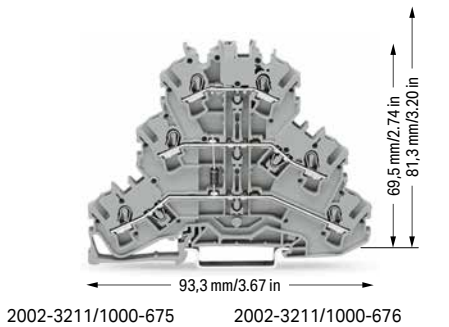

Triple-deck diode terminal block; with 1N4007 diode; gray

	Item No.	Pack. Unit
○ anode bottom	2002-3211/1000-675	50
○ anode top	2002-3211/1000-676	50

① Conductor range: 0.25 ... 4 mm² "s+f-st";
 Push-in termination: 1 ... 4 mm² "s" and 1 ... 2.5 mm²
 "insulated ferrules, 12 mm"
 Depending on the conductor characteristic, a conductor
 with a smaller cross section can also be inserted
 via push-in termination.

Approvals and corresponding ratings,
 visit www.wago.com

Accessories; 2002 Series
 Appropriate marking systems:
 WMB/WMB Inline/Marking strips

End and intermediate plate; 0.8 mm thick

	orange	2002-3292	100 (25)
	gray	2002-3291	100 (25)

Insulation stop; 5 pcs/strip; 0.25 ... 0.5 mm²

	light gray	2002-171	200 (25)
---	------------	----------	----------

Insulation stop; 5 pcs/strip; 0.75 ... 1 mm²

	dark gray	2002-172	200 (25)
---	-----------	----------	----------

Push-in type jumper bar; insulated; I_N 25 A; light gray

	2-way	2002-402	25
	3-way	2002-403	25
	4-way	2002-404	25
	5-way	2002-405	25
	6-way	2002-406	25
	7-way	2002-407	25
	8-way	2002-408	25
	9-way	2002-409	25
	10-way	2002-410	25

Push-in type jumper bar; insulated; I_N 25 A; light gray

	1 to 3	2002-433	25
	1 to 4	2002-434	25
	1 to 5	2002-435	25
	1 to 6	2002-436	25
	1 to 7	2002-437	25
	1 to 8	2002-438	25
	1 to 9	2002-439	25
	1 to 10	2002-440	25

Modular connector; snaps together; for jumper contact slot

	gray	2002-511	100 (25)
---	------	----------	----------

Spacer module; snaps together; bridges commoned terminal blocks

	gray	2002-549	100 (25)
---	------	----------	----------

Test plug adapter; for 4 mm Ø test plug

	gray	2009-174	100 (25)
---	------	----------	----------

Testing tap; for max. 2.5 mm²

	gray	2009-182	100 (25)
---	------	----------	----------

Accessories; 2002 Series
 Appropriate marking systems:
 WMB/WMB Inline/Marking strips

Marking strip; plain; 11 mm wide; 50 m reel

	white	2009-110	1
---	-------	----------	---

WMB Inline, plain; 1,500 WMB markers (5 mm)/reel; 5 ... 5.2 mm stretchable

	white	2009-115	1
---	-------	----------	---

WMB marking card; white; 10 strips with 10 markers/card; 5 ... 5.2 mm stretchable

	plain	793-5501	5
---	-------	----------	---

Triple-deck marker carrier; pivoting

	gray	2002-131	50 (25)
---	------	----------	---------



Double- and triple-deck LED terminal blocks:
 Using LED terminal blocks, monitoring units can be
 designed, e.g., for control and operating circuits.



Triple-deck diode terminal blocks were specifically devel-
 oped for custom diode circuits, such as lamp test and col-
 lective fault signal circuits.
 These terminal blocks provide high-density wiring in a
 width of just 5.2 mm.
 Push-in type jumper bars provide additional options for
 custom circuit design.

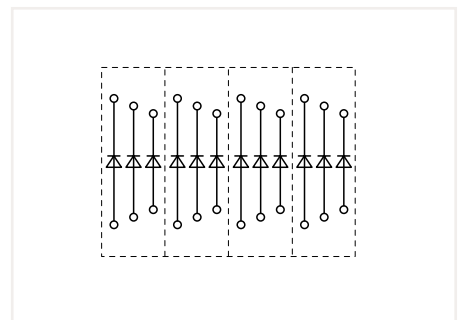



Open diode gates can be created and connected individu-
 ally using the following terminal blocks:
 2002-3212/1000-673 or 2002-3212/1000-674



Using push-in type jumper bars, individual decks can be
 turned into polarized diode gates.

Connector, Connector Strip TOPJOB® S



1 (1.5) mm²; 2000 Series and 1.5 (2,5) mm²; 2001 Series and 2.5 (4) mm²; 2002 Series

Technical Data	
0.14 ... 1 (1.5) mm ² ①	24 ... 16 AWG
500 V/6 kV/3 ④	300 V, 10 A 
I _N 13.5 A	300 V, 10 A 
Terminal block width: 3.5 mm / 0.138 inch	
 9 ... 11 mm / 0.35 ... 0.43 inch	



Technical Data	
0.14 ... 1 (1.5) mm ² ①	24 ... 16 AWG
500 V/6 kV/3 ④	600 V, 10 A 
I _N 13.5 A	300 V, 10 A 
Terminal block width: 5 mm / 0.197 inch	
 9 ... 11 mm / 0.35 ... 0.43 inch	



Technical Data	
0.25 ... 1.5 (2.5) mm ² ②	22 ... 14 AWG
500 V/6 kV/3 ④	300 V, 15 A 
I _N 18 A	300 V, 15 A 
Terminal block width: 4.2 mm / 0.165 inch	
 9 ... 11 mm / 0.35 ... 0.43 inch	



Modular connector; for jumper contact slot; snaps together; gray

	Item No.	Pack. Unit
<input type="radio"/> 1-pole	2000-510	100 (25)

Modular connector; with end plate; for jumper contact slot; snaps together; gray

	Item No.	Pack. Unit
<input type="radio"/> 1-pole	2000-511	100 (25)

Modular connector; for jumper contact slot; snaps together; gray

	Item No.	Pack. Unit
<input type="radio"/> 1-pole	2001-511	100 (25)

Spacer module; snaps together; bridges commoned terminal blocks

<input type="radio"/> gray	2000-549	100 (25)
----------------------------	----------	----------

Spacer module; snaps together; bridges commoned terminal blocks

<input type="radio"/> gray	2001-549	100 (25)
----------------------------	----------	----------

connector strip; for jumper contact slot; gray

<input type="radio"/> 2-pole	2000-552	25
<input type="radio"/> 3-pole	2000-553	25
<input type="radio"/> 4-pole	2000-554	25
<input type="radio"/> 5-pole	2000-555	10
<input type="radio"/> 6-pole	2000-556	10
<input type="radio"/> 7-pole	2000-557	10
<input type="radio"/> 8-pole	2000-558	10
<input type="radio"/> 9-pole	2000-559	10
<input type="radio"/> 10-pole	2000-560	10

connector strip; for jumper contact slot; gray

<input type="radio"/> 2-pole	2001-552	25
<input type="radio"/> 3-pole	2001-553	25
<input type="radio"/> 4-pole	2001-554	25
<input type="radio"/> 5-pole	2001-555	10
<input type="radio"/> 6-pole	2001-556	10
<input type="radio"/> 7-pole	2001-557	10
<input type="radio"/> 8-pole	2001-558	10
<input type="radio"/> 9-pole	2001-559	10
<input type="radio"/> 10-pole	2001-560	10

Accessories; item-specific

WMB Inline; plain; 2,300 WMB markers (3.5 mm)/reel

	white	2009-113	1
---	-------	----------	---

Accessories; item-specific

WMB Inline; plain; 1,500 WMB markers (5 mm)/reel; 5 ... 5.2 mm stretchable

	white	2009-115	1
---	-------	----------	---

Accessories; item-specific

WMB Inline; plain; 2,000 WMB markers (4 mm)/reel; 4 ... 4.2 mm stretchable

	white	2009-114	1
---	-------	----------	---

WMB marking card; white; 10 strips with 10 markers/card; for 3.5 mm terminal block width

	plain	793-3501	5
--	-------	----------	---

WMB marking card; white; 10 strips with 10 markers/card; 5 ... 5.2 mm stretchable

	plain	793-5501	5
---	-------	----------	---

WMB marking card; white; 10 strips with 10 markers/card; 4 ... 4.2 mm stretchable

	plain	793-4501	5
---	-------	----------	---

Accessories; 2000 Series

Appropriate marking systems: WMB/WMB Inline/Marking strips

End plate; for modular connector; 1.5 mm thick

	gray	2002-541	100 (25)
---	------	----------	----------

Test plug; with 500 mm cable; 2 mm Ø; max. 42 V

	red	210-136	50 (1)
---	-----	---------	--------

Strain relief plate; gray

	35 mm wide	734-326	100 (25)
	6 mm wide	734-327	100 (25)
	12.5 mm wide	734-328	100 (25)
	25 mm wide	734-329	100 (25)

Technical Data

0.25 ... 2.5 (4) mm ² ③	22 ... 12 AWG
500 V/6 kV/3 ④	300 V, 20 A ⑤
I _n 24 A	300 V, 20 A ⑥
Terminal block width: 5.2 mm / 0.205 inch	
 10 ... 12 mm / 0.39 ... 0.47 inch	



Modular connector; for jumper contact slot; snaps together; gray

	Item No.	Pack. Unit
○ 1-pole	2002-511	100 (25)

Spacer module; snaps together; bridges commoned terminal blocks

○ gray	2002-549	100 (25)
--------	----------	----------

connector strip; for jumper contact slot; gray

○ 2-pole	2002-552	25
○ 3-pole	2002-553	25
○ 4-pole	2002-554	25
○ 5-pole	2002-555	10
○ 6-pole	2002-556	10
○ 7-pole	2002-557	10
○ 8-pole	2002-558	10
○ 9-pole	2002-559	10
○ 10-pole	2002-560	10

Accessories; item-specific

WMB Inline, plain; 1,500 WMB markers (5 mm)/reel; 5 ... 5.2 mm stretchable

	white	2009-115	1
---	-------	----------	---

WMB marking card; white; 10 strips with 10 markers/card; 5 ... 5.2 mm stretchable

	plain	793-5501	5
---	-------	----------	---

Marking strip; plain; 11 mm wide; 50 m reel

	white	2009-110	1
---	-------	----------	---

① Conductor range: 0.14 ... 1.5 mm² "s+f-st"; Push-in termination: 0.5 ... 1.5 mm² "s" and 0.5 ... 0.75 mm² "insulated ferrules; 10 mm" Depending on the conductor characteristic, a conductor with a smaller cross section can also be inserted via push-in termination.

② Conductor range: 0.25 ... 2.5 mm² "s+f-st"; Push-in termination: 0.75 ... 2.5 mm² "s" and 0.75 ... 1.5 mm² "insulated ferrules; 12 mm" Depending on the conductor characteristic, a conductor with a smaller cross section can also be inserted via push-in termination.

③ Conductor range: 0.25 ... 4 mm² "s+f-st"; Push-in termination: 1 ... 4 mm² "s" and 1 ... 2.5 mm² "insulated ferrules; 12 mm" Depending on the conductor characteristic, a conductor with a smaller cross section can also be inserted via push-in termination.

④ 500 V = rated voltage
6 kV = rated impulse voltage
3 = pollution degree (see Section 15)

Note:
According to EN 61984, pluggable connectors without a current interrupting capacity must not be mated or unmated when live or under load.

Approvals and corresponding ratings, visit www.wago.com

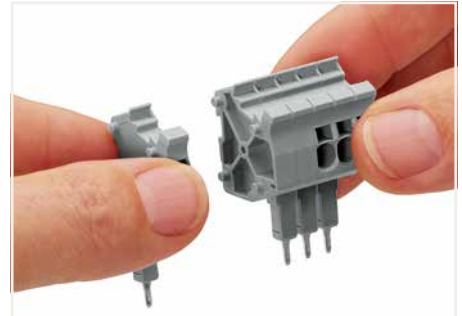

Snapping connectors and spacers together to assemble a multipole connector.

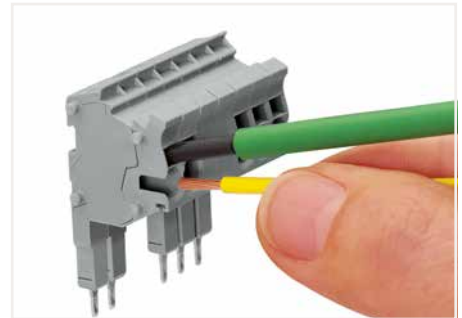

Operating tool for fine-stranded conductors without ferrules – push-in connection of solid conductors



Rail-mount terminal block assembly for electric motor wiring



Snapping on a strain relief plate.



The modular connectors also connect conductors of the same size as the terminal blocks being used.

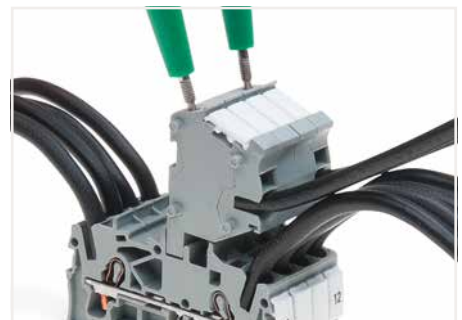

Connectors with a 2 mm Ø test socket for testing voltage via 2-pole voltage tester

Connector, Connector Strip TOPJOB® S

4 (6) mm²; 2004 Series; 2006 Series; 2010 Series and 2016 Series

1

Technical Data

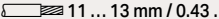
0.5 ... 4 (6) mm ² ①	22 ... 10 AWG
500 V/6 kV/3 ②	300 V, 30 A ③
I _N 32 A	300 V, 30 A ④
Terminal block width: 6.2 mm / 0.244 inch	
 11 ... 13 mm / 0.43 ... 0.51 inch	

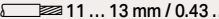

Technical Data

0.5 ... 4 (6) mm ² ①	22 ... 10 AWG
500 V/6 kV/3 ②	I _N 32 A
Terminal block width: 7.5 mm / 0.295 inch	
 11 ... 13 mm / 0.43 ... 0.51 inch	



Technical Data

0.5 ... 4 (6) mm ² ①	22 ... 10 AWG
500 V/6 kV/3 ②	I _N 32 A
Terminal block width: 10 mm / 0.394 inch	
 11 ... 13 mm / 0.43 ... 0.51 inch	



Modular connector; for jumper contact slot; snaps together; gray

	Item No.	Pack. Unit
<input type="radio"/> 1-pole	2004-511	100 (25)

Modular connector; for jumper contact slot; snaps together; gray

	Item No.	Pack. Unit
<input type="radio"/> 1-pole	2006-511	50 (25)

Modular connector; for jumper contact slot; snaps together; gray

	Item No.	Pack. Unit
<input type="radio"/> 1-pole	2010-511	50 (25)

Spacer module; snaps together; bridges commoned terminal blocks

<input type="radio"/> gray	2004-549	100 (25)
----------------------------	----------	----------

Spacer module; snaps together; bridges commoned terminal blocks

<input type="radio"/> gray	2006-549	50 (25)
----------------------------	----------	---------

Spacer module; snaps together; bridges commoned terminal blocks

<input type="radio"/> gray	2010-549	50 (25)
----------------------------	----------	---------

connector strip; for jumper contact slot; gray

<input type="radio"/> 2-pole	2004-552	25
<input type="radio"/> 3-pole	2004-553	25
<input type="radio"/> 4-pole	2004-554	25
<input type="radio"/> 5-pole	2004-555	10

Accessories, for connector strips

Appropriate marking systems: WMB/WMB Inline/Marking strips

End plate; for modular connector; 1.5 mm thick

gray	2004-541	100 (25)
------	----------	----------



Test plug; with 500 mm cable; 2 mm Ø; max. 42 V

red	210-136	50 (1)
-----	---------	--------



Strain relief plate; gray

35 mm wide	734-326	100 (25)
6 mm wide	734-327	100 (25)
12.5 mm wide	734-328	100 (25)
25 mm wide	734-329	100 (25)



Marking strip; plain; 11 mm wide; 50 m reel

white	2009-110	1
-------	----------	---



WMB marking card; white; 10 strips with 10 markers/card; 5 ... 5.2 mm stretchable

plain	793-5501	5
-------	----------	---



Technical Data

0.5 ... 4 (6) mm² ① | 22 ... 10 AWG

500 V/6 kV/3 ②

I_N 32 A

Terminal block width: 12 mm / 0.472 inch

 11 ... 13 mm / 0.43 ... 0.51 inch

① Conductor range: 0.5 ... 6 mm² "s+f-st";
Push-in termination: 1.5 ... 6 mm² "s" and 1.5 ... 4 mm² "insulated ferrules; 12 mm"
Depending on the conductor characteristic, a conductor with a smaller cross section can also be inserted via push-in termination.

② 500 V = rated voltage
6 kV = rated impulse voltage
3 = pollution degree
(see Section 15)

Note:

According to EN 61984, pluggable connectors without a current interrupting capacity must not be mated or unmated when live or under load.

Approvals and corresponding ratings, visit www.wago.com

Modular connector; for jumper contact slot; snaps together; gray

	Item No.	Pack. Unit
○ 1-pole	2016-511	50 (25)

Spacer module; snaps together; bridges commoned terminal blocks

○ gray	2016-549	50 (25)
--------	----------	---------

PUSH-IN CAGE CLAMP®

L-Type Test Plug Module TOPJOB® S for Testing 5.2 mm Wide Rail-Mount Terminal Blocks – via Conductor Entries

2.5 (4) mm²; 2002 Series

1

Technical Data

0.25 ... 2.5 (4) mm² ① | 22 ... 12 AWG

500 V/6 kV/3 ②

I_N 18 A

Terminal block width: 5.2 mm / 0.205 inch

10 ... 12 mm / 0.39 ... 0.47 inch



- ① Conductor range: 0.25 ... 4 mm² "s+f-st"; Push-in termination: 1 ... 4 mm² "s" and 1 ... 2.5 mm² "insulated ferrules, 12 mm"
Depending on the conductor characteristic, a conductor with a smaller cross section can also be inserted via push-in termination.
 - ② 500 V = rated voltage
6 kV = rated impulse voltage
3 = pollution degree (see Section 15)
- Approvals and corresponding ratings, visit www.wago.com

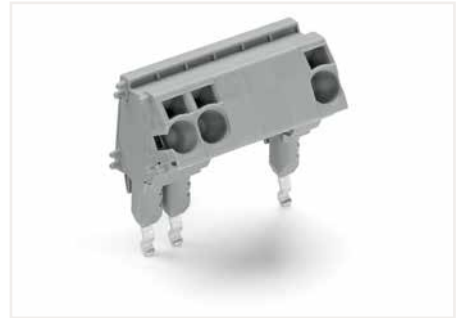

L-type test plug assembly:
L-type test plug modules and L-type spacer modules (max. 10-pole)
Additionally, terminal blocks can be skipped using spacer modules.

L-type test plug module; snaps together; gray
According to EN 61984, pluggable connectors without a current interrupting capacity must not be mated or unmated when live or under load.

	Item No.	Pack. Unit
○ 1-pole	2002-611	100 (25)

L-type spacer module; snaps together; bridges commoned terminal blocks

○ gray	2002-649	100 (25)
--------	----------	----------

Accessories; for L-type test plug modules

Appropriate marking systems:
WMB/WMB Inline/Mini-WSB

End plate; for modular test plug module; 1.5 mm thick

gray	2002-641	100 (25)
------	----------	----------

Test plug; with 500 mm cable; 2 mm Ø; max. 42 V

red	210-136	50 (1)
-----	---------	--------

Strain relief plate; gray

35 mm wide	734-326	100 (25)
6 mm wide	734-327	100 (25)
12.5 mm wide	734-328	100 (25)
25 mm wide	734-329	100 (25)

WMB Inline, plain; 1,500 WMB markers (5 mm)/reel; 5 ... 5.2 mm stretchable

white	2009-115	1
-------	----------	---

WMB marking card; white; 10 strips with 10 markers/card; 5 ... 5.2 mm stretchable

plain	793-5501	5
-------	----------	---



L-type test plug modules fitted in a triple-deck terminal block



L-type test plug modules for testing rail-mount terminal blocks via conductor entries

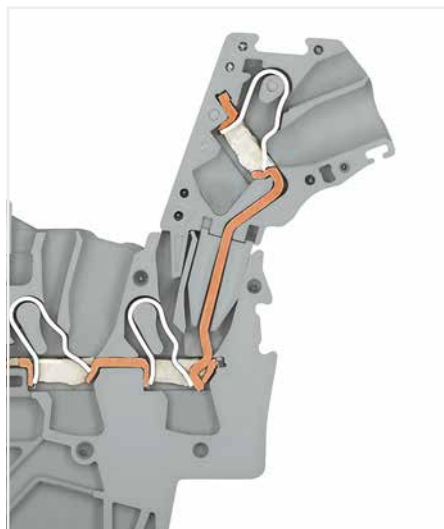

L-type test plug module – cross-sectional view of contacts

Test Plug Adapter, Testing Tap TOPJOB® S 2009 Series



Test plug adapter; for 4 mm Ø test plug; for testing Rail-Mount Terminal Blocks TOPJOB® S
Power must be switched off when installing the test plug adapter. The safety guidelines for working on live installations must be observed.

Color	Item No.	Pack. Unit
○ gray	2009-174	100 (25)

Testing tap; for max. 2.5 mm²; connects test cables (0.08 ... 2.5 mm²) without tool
Power must be switched off when installing the testing tap. The safety guidelines for working on live installations must be observed.

Color	Item No.	Pack. Unit
○ gray	2009-182	100 (25)

Item-Specific Accessories

Banana plug; for 4 mm socket diameter; color mixed; 10 x orange, white, black, blue, yellow; max. 42 V



215-111 50



Test plug adapter (2009-174, CAT I) for 4 mm Ø plugs – compatible with 2000 to 2016 Series



Testing tap (2009-182) for tool-free connection of test cables up to 2.5 mm² (12 AWG) – compatible with 2000 to 2016 Series

Colored Push-In Type Jumper Bar TOPJOB® S 2000 Series and 2002 Series

1



Push-in type jumper bar; insulated; I_N 14 A; red

	Item No.	Pack. Unit
● 2-way	2000-402/000-005	25
● 3-way	2000-403/000-005	25
● 4-way	2000-404/000-005	25
● 5-way	2000-405/000-005	25
● 6-way	2000-406/000-005	25
● 7-way	2000-407/000-005	25
● 8-way	2000-408/000-005	25
● 9-way	2000-409/000-005	25
● 10-way	2000-410/000-005	25

Push-in type jumper bar; insulated; I_N 14 A; blue

	Item No.	Pack. Unit
● 2-way	2000-402/000-006	25
● 3-way	2000-403/000-006	25
● 4-way	2000-404/000-006	25
● 5-way	2000-405/000-006	25
● 6-way	2000-406/000-006	25
● 7-way	2000-407/000-006	25
● 8-way	2000-408/000-006	25
● 9-way	2000-409/000-006	25
● 10-way	2000-410/000-006	25

Push-in type jumper bar; insulated; yellow-green

	Item No.	Pack. Unit
● 2-way	2000-402/000-018	25

Push-in type jumper bar; insulated; I_N 25 A; red

● 2-way	2002-402/000-005	25
● 3-way	2002-403/000-005	25
● 4-way	2002-404/000-005	25
● 5-way	2002-405/000-005	25
● 6-way	2002-406/000-005	25
● 7-way	2002-407/000-005	25
● 8-way	2002-408/000-005	25
● 9-way	2002-409/000-005	25
● 10-way	2002-410/000-005	25

Push-in type jumper bar; insulated; I_N 25 A; blue

● 2-way	2002-402/000-006	25
● 3-way	2002-403/000-006	25
● 4-way	2002-404/000-006	25
● 5-way	2002-405/000-006	25
● 6-way	2002-406/000-006	25
● 7-way	2002-407/000-006	25
● 8-way	2002-408/000-006	25
● 9-way	2002-409/000-006	25
● 10-way	2002-410/000-006	25



For example, colored push-in type jumper bars are used with sensor terminal blocks.

Adjacent Jumper for Continuous Commoning TOPJOB® S 2002 Series

Technical Data	
800 V	
I_N 25 A	

Technical Data	
800 V/8 kV/3	
I_N 25 A	



Adjacent jumper for continuous commoning; insulated; light gray		
	Item No.	Pack. Unit
○ 2-way	2002-400	25

Adjacent jumper for continuous commoning; insulated; 1 to 3		
Color	Item No.	Pack. Unit
○ light gray	2002-423	25
● red	2002-423/000-005	25
● blue	2002-423/000-006	25



Continuous jumpers (2002 Series) readily connect an endless number of terminal blocks to each other via single jumper slot. Use the second jumper slot for additional commoning or testing.

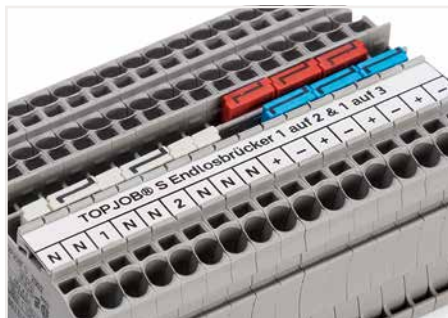

The 1-to-3 adjacent jumper for continuous commoning enables every other terminal block to be commoned. For example, positive and negative potentials can be accommodated alongside each other.

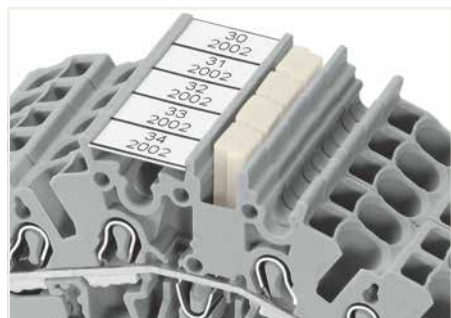

Adjacent jumpers for continuous commoning (2002-400)

Staggered Jumper TOPJOB® S 2002 Series

1

Technical Data

400 V/6 kV/3
I_N 25 A

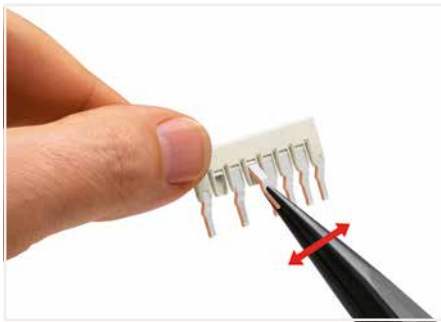

Staggered jumper (seven contacts):
Individual jumper contacts can be broken off by bending them. The remaining piece of insulation will meet requirements for clearances and creepage distances.



Staggered jumpers (seven contacts)

Staggered jumper; insulated; for 2002, 2003, 2022 and 2002 Series Rail-Mount Terminal Blocks; light gray

	Item No.	Pack. Unit
<input type="radio"/> 2-way	2002-472	25
<input type="radio"/> 3-way	2002-473	25
<input type="radio"/> 4-way	2002-474	25
<input type="radio"/> 5-way	2002-475	25
<input type="radio"/> 6-way	2002-476	25
<input type="radio"/> 7-way	2002-477	25
<input type="radio"/> 8-way	2002-478	25
<input type="radio"/> 9-way	2002-479	25
<input type="radio"/> 10-way	2002-480	25
<input type="radio"/> 11-way	2002-481	25
<input type="radio"/> 12-way	2002-482	25

Customized staggered jumper; insulated; with contact lugs broken off at the factory and circuit printing; light gray

<input type="radio"/> 1-3	2002-473/011-000	25
<input type="radio"/> 1-3-5	2002-475/011-000	25
<input type="radio"/> 1-3-5-7	2002-477/011-000	25
<input type="radio"/> 1-3-5-7-9	2002-479/011-000	25
<input type="radio"/> 1-3-5-7-9-11	2002-481/011-000	25

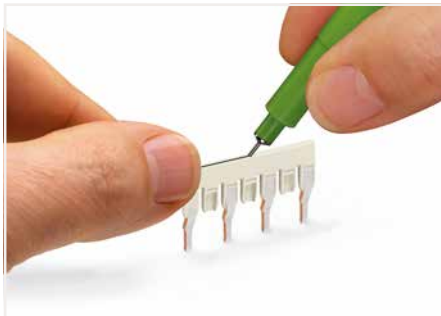

Staggered jumper:
Marking with a felt-tip pen.



Locate red stripes of the staggered jumpers on the inside. Insert staggered jumper and push down until it hits backstop.

Commoning using staggered jumpers:

Individual jumper contacts can be broken off by bending them. The remaining piece of insulation will meet requirements for clearances and creepage distances. Custom staggered jumpers can be created, e.g., for bridging over a terminal block with a different potential. Make sure that only one contact lug is in contact with the terminal block.

The contact lugs of the customized staggered jumpers contact the terminal blocks via the gaps created in the second jumper. Insert and press the ready-made jumper assembly into the jumper slot until it hits backstop.



Staggering jumpers in a single jumper slot.
Custom staggered jumpers can be created, e.g., for bridging over a terminal block with a different potential. Make sure that only one contact lug is in contact with the terminal block. The contact lugs of the customized staggered jumpers contact the terminal blocks via the gaps created in the second jumper. Insert and press the ready-made jumper assembly into the jumper slot until it hits backstop.

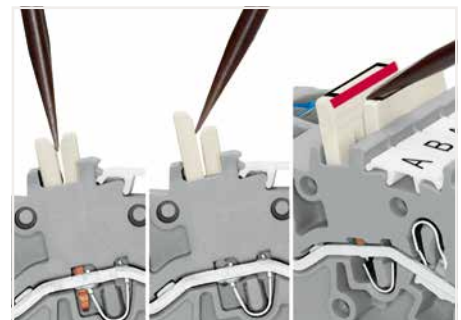

Removing a staggered jumper:
Insert the operating tool between the staggered jumpers, then lift up the jumper.



Commoning two potentials in one single jumper slot via extremely slim staggered jumpers.

Star Point Jumper, Delta Jumper, Collective Jumper Carrier TOPJOB® S

Technical Data
800 V/8 kV/3
$I_N = I_N$ terminal block

Technical Data
800 V/8 kV/3
$I_N = I_N$ terminal block



Star point jumper; insulated; 1-3-5; light gray		
	Item No.	Pack. Unit
<input type="radio"/>	2000-405/011-000	25
<input type="radio"/>	2001-405/011-000	25
<input type="radio"/>	2002-405/011-000	25
<input type="radio"/>	2004-405/011-000	25
<input type="radio"/>	2006-405/011-000	25
<input type="radio"/>	2010-405/011-000	25
<input type="radio"/>	2016-405/011-000	25

Delta jumper; insulated; 1-2 3-4 5-6; light gray		
	Item No.	Pack. Unit
<input type="radio"/>	2000-406/020-000	25
<input type="radio"/>	2001-406/020-000	25
<input type="radio"/>	2002-406/020-000	25
<input type="radio"/>	2004-406/020-000	25

Collective jumper carrier; for DIN-35 rail; for 2000 to 2016 Series jumpers		
Color	Item No.	Pack. Unit
<input type="radio"/> gray	2009-180	25



This star point jumper has been specially developed to create a "star point" and is used on motor terminal boards equipped with rail-mount terminal blocks TOPJOB® S.



This delta jumper has been specially developed to create a delta configuration and is used on motor terminal boards equipped with rail-mount terminal blocks TOPJOB® S.



Collective jumper carrier

Push-In Type Wire Jumper TOPJOB® S 2009 Series

1

Technical Data
800 V/8 kV/3
I _N 9 A

Technical Data
800 V/8 kV/3
I _N 18 A

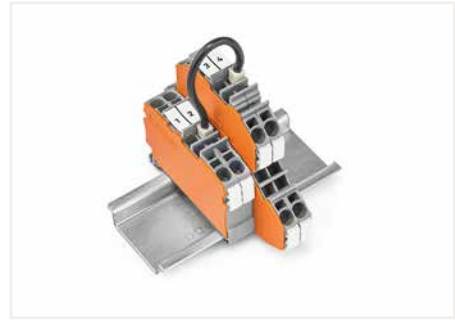

Push-in type wire jumpers connect terminal blocks over longer distances and across multiple levels.

Push-in type wire jumper; insulated; 0.75 mm² conductor cross-section; for 2000, 2020 and 2200 Series Rail-Mount Terminal Blocks; gray

	Item No.	Pack. Unit
L = 60 mm	2009-402	100 (10)
L = 110 mm	2009-404	100 (10)
L = 250 mm	2009-406	100 (10)

Push-in type wire jumper; insulated; 1.5 mm² conductor cross-section; for 2001, 2002, 2003, 2022, 2201 and 2202 Series Rail-Mount Terminal Blocks; black

	Item No.	Pack. Unit
L = 60 mm	2009-412	100 (10)
L = 110 mm	2009-414	100 (10)
L = 250 mm	2009-416	100 (10)



Push-in type wire jumper; insulated; L = 110 mm; 1.5 mm² conductor cross-section; for 2001, 2002, 2003, 2022, 2201 and 2202 Series Rail-Mount Terminal Blocks

Color	Item No.	Pack. Unit
● red	2009-414/000-005	100 (10)
● blue	2009-414/000-006	100 (10)



Push down the wire jumper until fully inserted. Lift the jumper with an operating tool for rewiring.

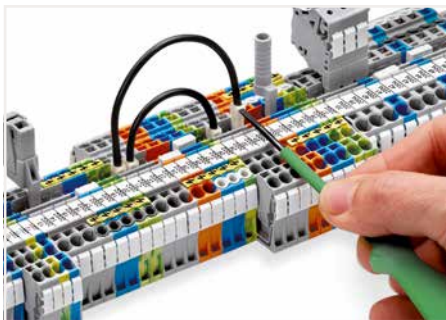

Push down the wire jumper until fully inserted. Lift the jumper with an operating tool for rewiring.

Vertical Jumper TOPJOB® S 2000 Series and 2002 Series

Technical Data	
500 V/6 kV/3	
I _N 13.5 A	



Technical Data	
500 V/6 kV/3	
I _N 24 A	



Technical Data	
500 V/6 kV/3	
I _N 24 A	



Double-deck vertical jumper; insulated		
Color	Item No.	Pack. Unit
○ light gray	2000-492	100 (25)

Double-deck vertical jumper; insulated		
Color	Item No.	Pack. Unit
○ light gray	2002-492	100 (25)
● orange	2002-492/000-012	100 (25)

Triple-deck vertical jumper; insulated		
Color	Item No.	Pack. Unit
○ light gray	2002-493	100 (25)

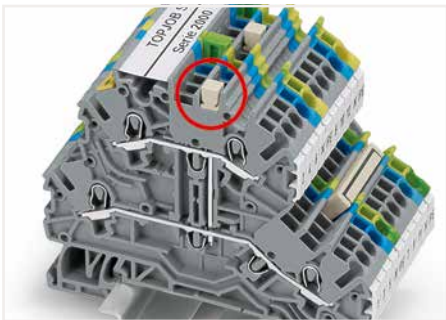

Commoning two levels via double-deck vertical jumper (2000-492).

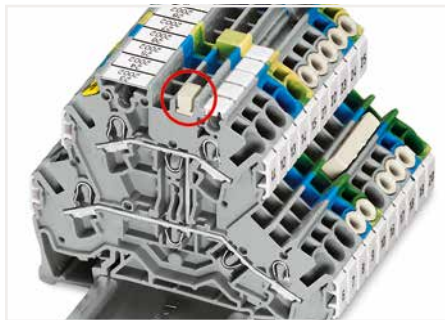

Commoning two levels via double-deck vertical jumper (2002-492).

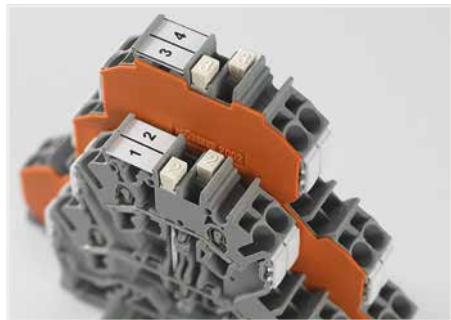

Created for double- and triple-deck terminal blocks TOPJOB® S, the vertical jumpers can common two or three levels. Clearly marked numerals ("2" and "3") distinguish the double-deck (2002-492) and triple-deck vertical jumpers (2002-493), even when inserted.



Commoning three levels via triple-deck vertical jumper (2002-493).

Disconnect plug, Blind Plug for Carrier Terminal Block TOPJOB® S 2002 Series and 2006 Series

1

Technical Data	
400 V/6 kV/3	
I _N 10 A	

Technical Data	
800 V/8 kV/3	
I _N 30 A	



Disconnect plug for carrier terminal blocks; suitable when using a carrier terminal block as disconnect terminal block

Color	Item No.	Pack. Unit
● orange	2002-401	100 (25)

Disconnect plug for carrier terminal blocks; suitable when using a carrier terminal block as disconnect terminal block

Color	Item No.	Pack. Unit
● orange	2006-401	100 (25)
○ white	2006-401/000-050	100 (25)

Blind plug for carrier terminal block; indicates a disconnection

Color	Item No.	Pack. Unit
● red	2006-451	100 (25)

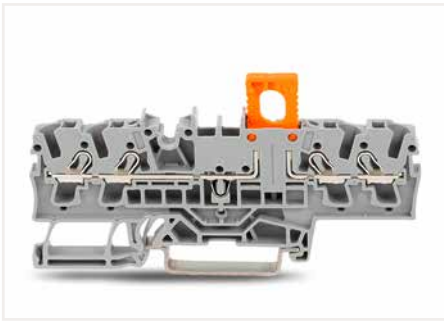

Carrier terminal block (2002-1661) with disconnect plug (2002-401) in operating position

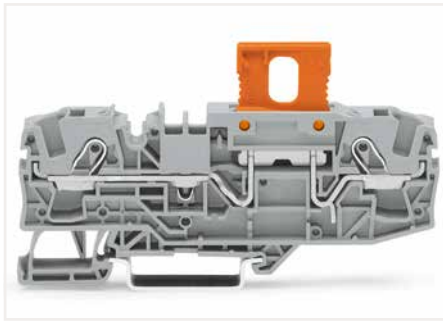

Carrier terminal block (2006-1661) with disconnect plug (2006-401) in operating position

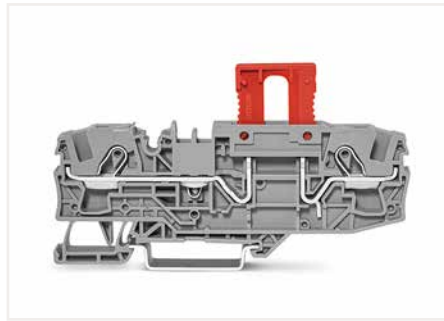

Blind plug (2006-451) for carrier terminal block; indicates a disconnection

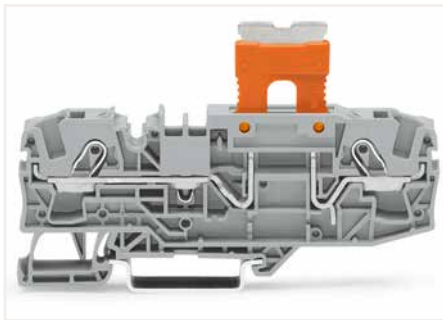

Carrier terminal block (2006-1661) with disconnect plug (2006-401) in parked position

Lockout Cap TOPJOB® S

2002 Series and 2006 Series

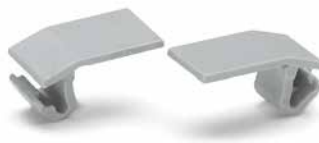
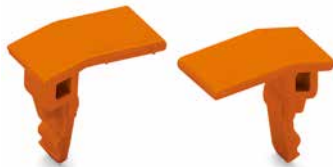

Lockout cap; for conductor entry and operating slot		
Color	Item No.	Pack. Unit
● orange	2002-192	25
○ gray	2002-191	25
● blue	2002-194	25

Lockout cap; for conductor entry and operating slot		
Color	Item No.	Pack. Unit
○ gray	2006-191	25



Creating spacer housings for electric motor wiring rail-mount terminal blocks via lockout caps (2002-192) for conductor entry and operating slot.



Cover (2006-191) seals unused conductor entry.

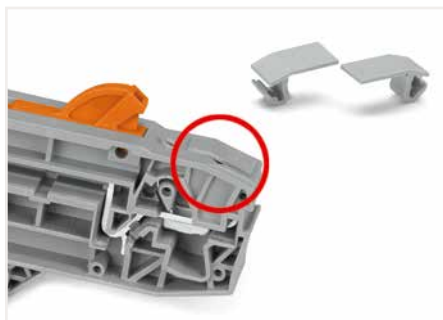

Cover (2006-191) seals unused conductor entry.

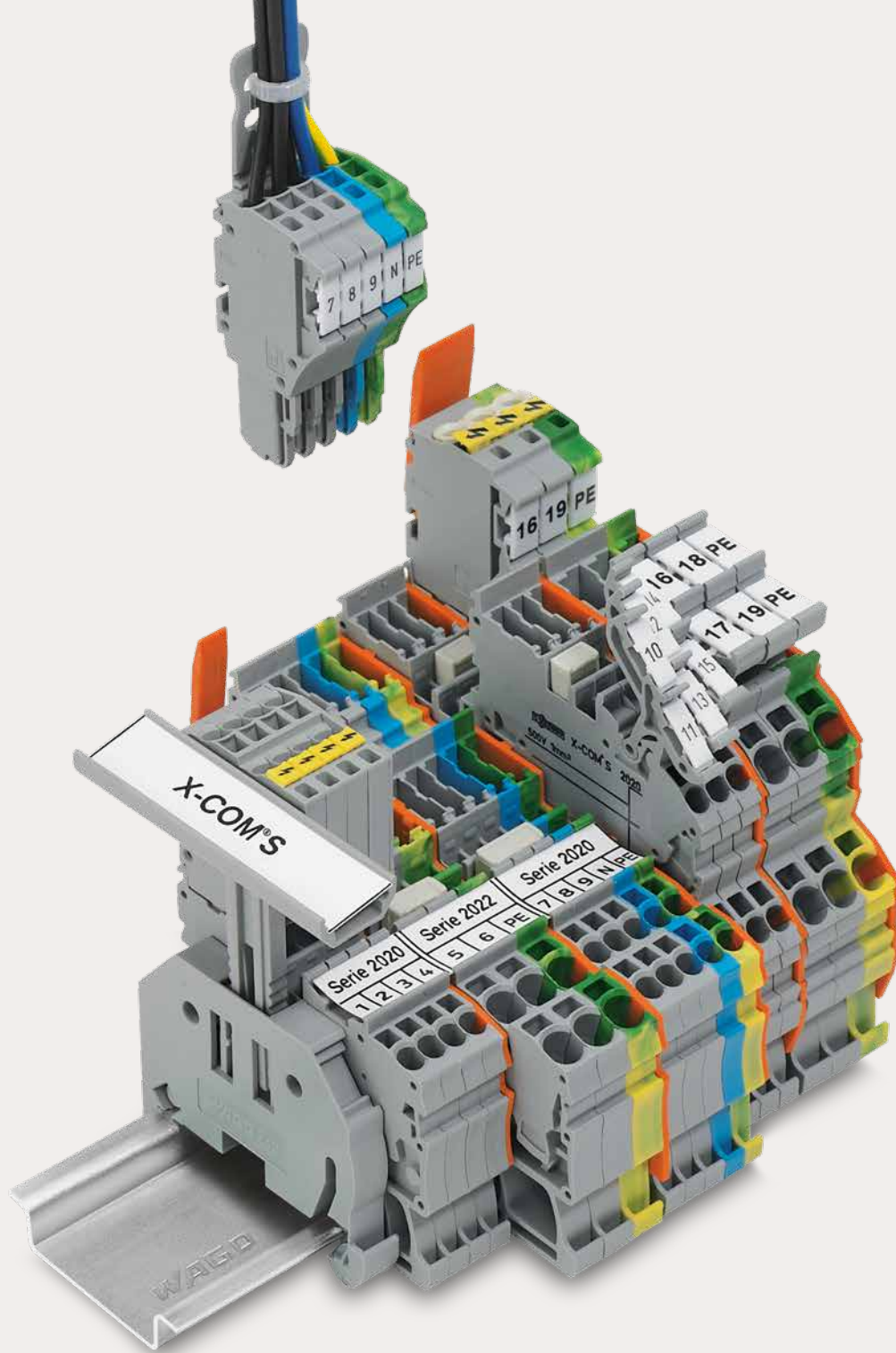

WAGO Rail-Mount Terminal Blocks with a Pluggable Connector X-COM[®]S-SYSTEM

WAGO Rail-Mount Terminal Blocks with a Pluggable Connector X-COM®S-SYSTEM Front-Entry Wiring

			Page
	X-COM®S-SYSTEM-MINI Through Carrier Terminal Blocks and Ground Conductor Carrier Terminal Blocks 0.14 ... 1 (1.5) mm ² (24 ... 16 AWG)	2020 Series	186
	Double-Deck Carrier Terminal Blocks 0.14 ... 1 (1.5) mm ² (24 ... 16 AWG)	2020 Series	188
	1-Conductor Female Plugs and 2-Conductor Female Plugs 0.14 ... 1 (1.5) mm ² (24 ... 16 AWG)	2020 Series	190
	1-Conductor Female Plugs and 2-Conductor Female Plugs for Self-Assembly 0.14 ... 1 (1.5) mm ² (24 ... 16 AWG)	2020 Series	192
	1-Conductor Female Plugs and 2-Conductor Female Plugs with Lateral Locking Levers and Strain Relief Plates 0.14 ... 1 (1.5) mm ² (24 ... 16 AWG)	2020 Series	198
	X-COM®S-SYSTEM Through Carrier Terminal Blocks and Ground Conductor Carrier Terminal Blocks 0.25 ... 2.5 (4) mm ² (22 ... 12 AWG)	2022 Series	202
	Double-Deck Carrier Terminal Blocks 0.25 ... 2.5 (4) mm ² (22 ... 12 AWG)	2022 Series	206
	1-Conductor Female Plugs 0.25 ... 2.5 (4) mm ² (22 ... 12 AWG)	2022 Series	208
	1-Conductor Female Plugs for Self-Assembly 0.25 ... 2.5 (4) mm ² (22 ... 12 AWG)	2022 Series	210
	1-Conductor Female Plugs with Lateral Locking Levers and Strain Relief Plates 0.25 ... 2.5 (4) mm ² (22 ... 12 AWG)	2022 Series	214
	X-COM®S-SYSTEM, for Exec Applications Through Carrier Terminal Blocks and Ground Conductor Carrier Terminal Blocks	2022 Series	216
	Double-Deck Carrier Terminal Blocks 0.25 ... 2.5 (4) mm ² (22 ... 12 AWG)		220
	1-Conductor Female Plugs 0.25 ... 2.5 (4) mm ² (22 ... 12 AWG)	2022 Series	222

X-COM®S-SYSTEM-MINI; 2020 Series X-COM®S-SYSTEM; 2022 Series Description and Installation

2

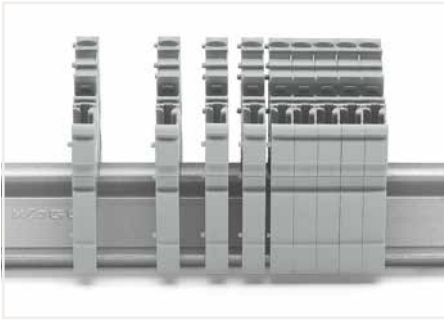

Snap individual carrier terminal blocks onto the DIN-rail and slide together.



Open the assembly by laterally sliding a block via operating tool (3.5 x 0.5 mm blade).

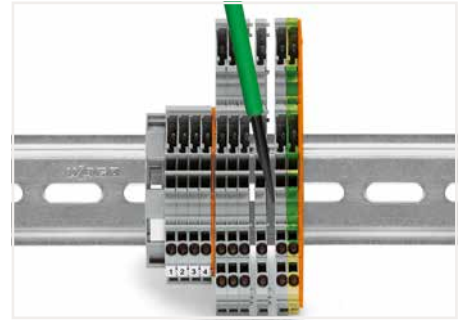

Separate terminal block assembly and slide individual terminal blocks laterally using an operating tool.



Carrier terminal blocks and female plugs are touch-proof.



Push-in CAGE CLAMP® enables solid conductors to be connected by simply pushing them into the unit.

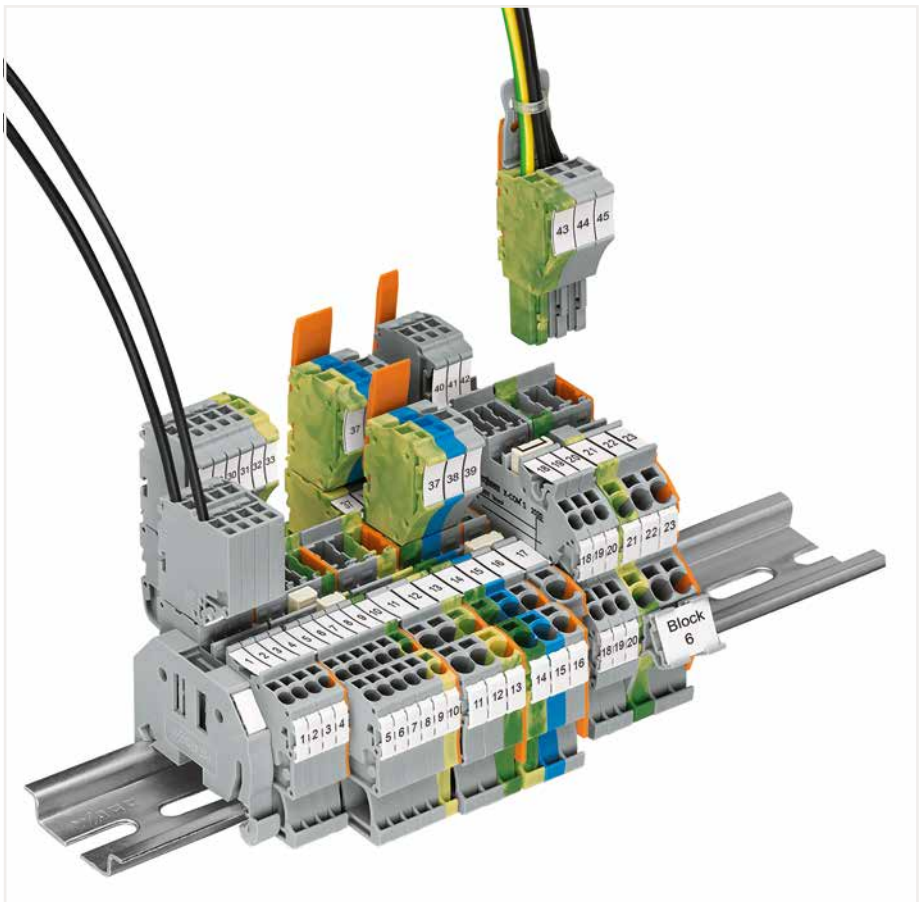

Note: Female plugs used according to the regulations must not be connected/disconnected when live or under load.



Insert coding pin into the corresponding slot and twist it off.



Coding a female plug: remove coding finger using a suitable tool.

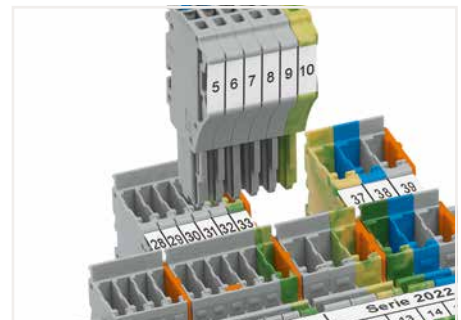

Insert coded female connector into X-COM®S-SYSTEM terminal block assembly.



Push-in CAGE CLAMP® terminates the following copper conductors:
solid "s"



stranded "st"



fine-stranded "f-st", also with tinned single strands

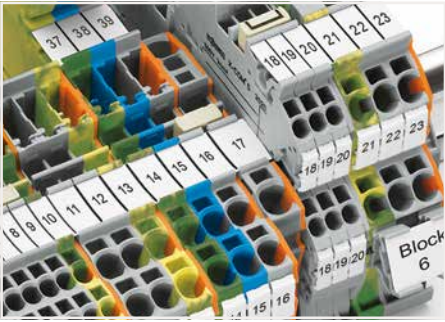

Commoning X-COM®S-SYSTEM Terminal Blocks using jumpers for Terminal Blocks TOPJOB® S. An end plate provides connection to Terminal Blocks TOPJOB® S. 2020 and 2022 Series Terminal Blocks are combinable. Jumper slots are on the same level for both series.



Pairing push-in comb style jumpers.

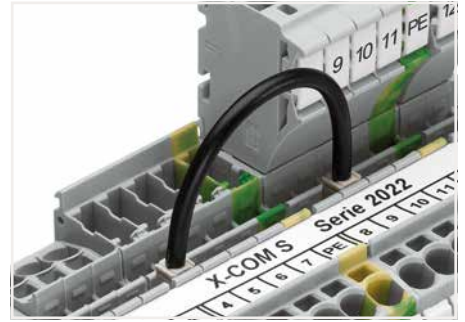

Commoning with push-in type wire jumper.

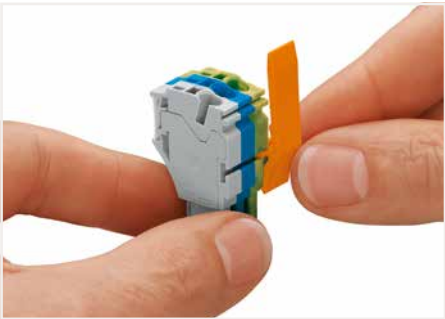

Slide the locking lever into position.

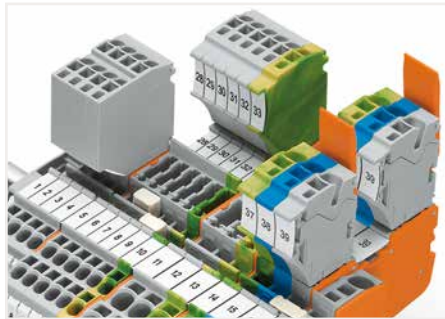

Female plugs can be individually locked.

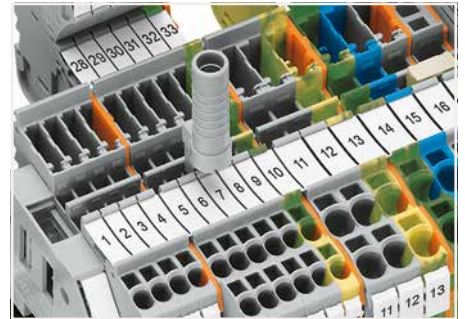

Test plug adapter (2009-174) for 4 mm test plugs or banana plugs – also suitable for X-COM®S-SYSTEM-MINI Terminal Blocks.

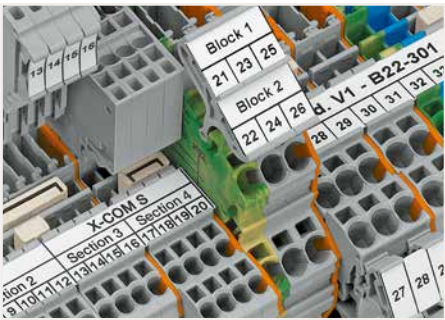

Clear marking via large marking area

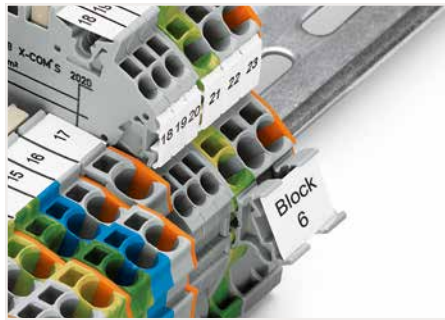

Marker carrier (2009-198)



fine-stranded, tip-bonded



fine-stranded, with ferrule (gastight crimped)



fine-stranded, with pin terminal (gastight crimped)

1-Conductor/1-Pin Carrier Terminal Block, 2-Conductor/1-Pin Carrier Terminal Block, 2-Conductor/2-Pin Carrier Terminal Block X-COM®S-SYSTEM-MINI 1 (1.5) mm²; 2020 Series

Technical Data	
0.14 ... 1 (1.5) mm ² ①	24 ... 16 AWG
500 V/6 kV/3 ②	300 V, 15 A ③
I _N 13.5 A ④	300 V, 10 A ⑤
Terminal block width: 3.5 mm / 0.138 inch	
9 ... 11 mm / 0.35 ... 0.43 inch	

Technical Data	
0.14 ... 1 (1.5) mm ² ①	24 ... 16 AWG
500 V/6 kV/3 ②	300 V, 15 A ③
I _N 13.5 A ④	300 V, 10 A ⑤
Terminal block width: 3.5 mm / 0.138 inch	
9 ... 11 mm / 0.35 ... 0.43 inch	

Technical Data	
0.14 ... 1 (1.5) mm ² ①	24 ... 16 AWG
500 V/6 kV/3 ②	300 V, 15 A ③
I _N 13.5 A ④	300 V, 10 A ⑤
Terminal block width: 3.5 mm / 0.138 inch	
9 ... 11 mm / 0.35 ... 0.43 inch	

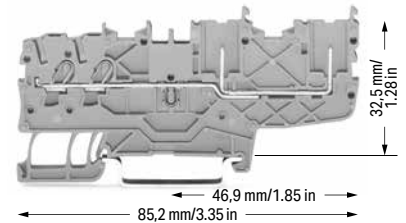
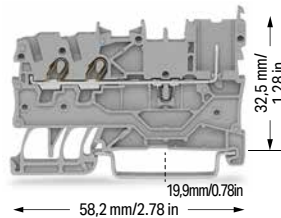
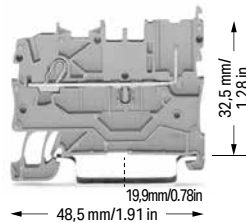

1-conductor/1-pin carrier terminal block		
Color	Item No.	Pack. Unit
○ gray	2020-1201	50
● blue	2020-1204	50

2-conductor/1-pin carrier terminal block		
Color	Item No.	Pack. Unit
○ gray	2020-1301	50
● blue	2020-1304	50

2-conductor/2-pin carrier terminal block		
Color	Item No.	Pack. Unit
○ gray	2020-1401	50
● blue	2020-1404	50

1-conductor/1-pin ground carrier terminal block		
Color	Item No.	Pack. Unit
● green-yellow	2020-1207	50

2-conductor/1-pin ground carrier terminal block		
Color	Item No.	Pack. Unit
● green-yellow	2020-1307	50

2-conductor/2-pin ground carrier terminal block		
Color	Item No.	Pack. Unit
● green-yellow	2020-1407	50

Accessories; item-specific			
End and intermediate plate; 1 mm thick			
	orange	2020-1292	100 (25)
	gray	2020-1291	100 (25)

Accessories; item-specific			
End and intermediate plate; 1 mm thick			
	orange	2020-1392	100 (25)
	gray	2020-1391	100 (25)

Accessories; item-specific			
End and intermediate plate; 1 mm thick			
	orange	2020-1492	100 (25)
	gray	2020-1491	100 (25)

Accessories; 2020 Series

Appropriate marking systems: WMB/WMB Inline/Marking strips

Push-in type jumper bar; insulated; I _N 14 A; light gray			
	2-way	2000-402	25
	3-way	2000-403	25
	4-way	2000-404	25
	5-way	2000-405	25
	6-way	2000-406	25
	7-way	2000-407	25
	8-way	2000-408	25
	9-way	2000-409	25
	10-way	2000-410	25

Protective warning marker; with black high-voltage symbol; for 5 terminal blocks			
	yellow	2000-115	100 (25)
Carrier with 6 coding pins; for coding female plugs			
	orange	2020-100	100 (25)
Test pin; 1 mm Ø			
		859-500	1

Marking strip; plain; 11 mm wide; 50 m reel			
	white	2009-110	1
WMB Inline; plain; 2,300 WMB markers (3.5 mm)/reel			
	white	2009-113	1
WMB marking card; white; 10 strips with 10 markers/card; for 3.5 mm terminal block width			
	plain	793-3501	5

Push-in type jumper bar; insulated; I _N 14 A; light gray			
	1 to 3	2000-433	25
	1 to 4	2000-434	25
	1 to 5	2000-435	25
	1 to 6	2000-436	25
	1 to 7	2000-437	25
	1 to 8	2000-438	25
	1 to 9	2000-439	25
	1 to 10	2000-440	25

Test plug adapter; for 4 mm Ø test plug			
	gray	2009-174	100 (25)
Testing tap; for max. 2.5 mm ²			
	gray	2009-182	100 (25)

Delta jumper; insulated; I _N = I _N terminal block; light gray			
	1-2 3-4 5-6	2000-406/020-000	25

1-conductor female plug			
	gray	2020-102	100
2-conductor female plug			
	gray	2020-202	100

Star point jumper; insulated; I _N = I _N terminal block; light gray			
	1-3-5	2000-405/011-000	25

Push-in type wire jumper; insulated; 0.75 mm ² conductor cross-section; I _N 9 A			
	L = 60 mm	2009-402	100 (10)
	L = 110 mm	2009-404	100 (10)
	L = 250 mm	2009-406	100 (10)

❶ Conductor range: 0.14 ... 1.5 mm² "s+f-st";
Push-in termination: 0.5 ... 1.5 mm² "s" and
0.5 ... 0.75 mm² "insulated ferrules; 10 mm"
Depending on the conductor characteristic, a conductor
with a smaller cross section can also be inserted
via push-in termination.

❷ 500 V = rated voltage
6 kV = rated impulse voltage
3 = pollution degree
(see Section 15)

❸ Current-carrying capacity curves upon request

Note:

When used as intended, female plugs must not be
connected/disconnected when live or under load.
An appropriate end plate must be applied to the
carrier terminal blocks after each female plug.

Please observe the application notes:
Jumpers, from page 174
Testing accessories, page 173
Marking, from page 640

Approvals and corresponding ratings,
visit www.wago.com

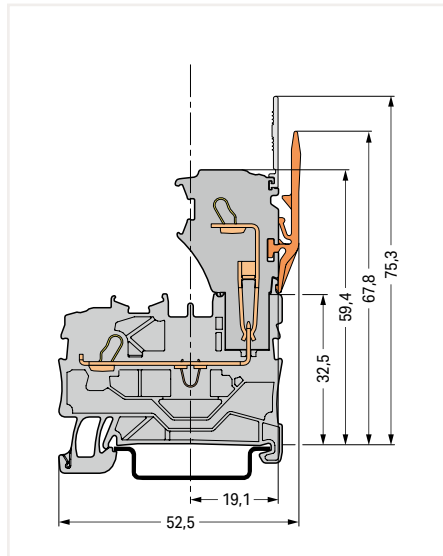

Carrier terminal block

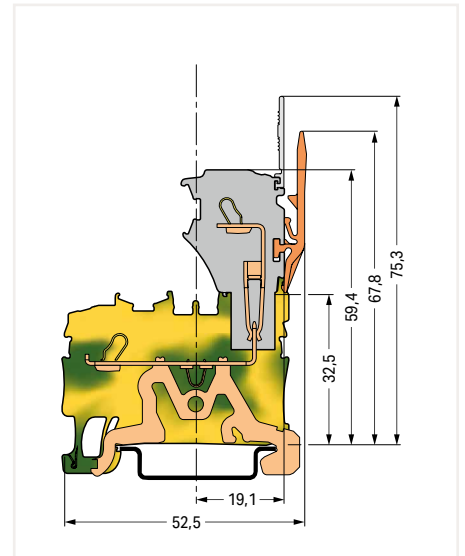

Ground carrier terminal block

1-Conductor/1-Pin Double-Deck Carrier Terminal Block X-COM®S-SYSTEM-MINI 1 (1.5) mm²; 2020 Series

Technical Data	
0.14 ... 1 (1.5) mm ² ①	24 ... 16 AWG
500 V/6 kV/3 ②	300 V, 15 A ③
I _N 13.5 A ④	300 V, 10 A ⑤
Terminal block width: 3.5 mm / 0.138 inch	
9 ... 11 mm / 0.35 ... 0.43 inch	

Technical Data	
0.14 ... 1 (1.5) mm ² ①	24 ... 16 AWG
500 V/6 kV/3 ②	300 V, 15 A ③
I _N 13.5 A ④	300 V, 10 A ⑤
Terminal block width: 3.5 mm / 0.138 inch	
9 ... 11 mm / 0.35 ... 0.43 inch	

Technical Data	
0.14 ... 1 (1.5) mm ² ①	24 ... 16 AWG
500 V/6 kV/3 ②	300 V, 15 A ③
I _N 13.5 A ④	300 V, 10 A ⑤
Terminal block width: 3.5 mm / 0.138 inch	
9 ... 11 mm / 0.35 ... 0.43 inch	

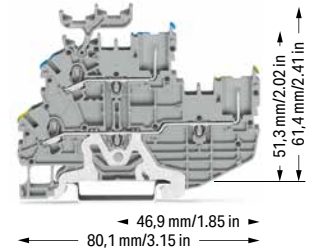
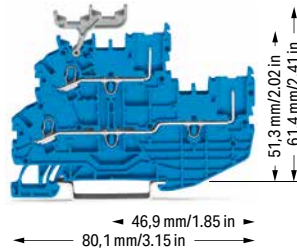
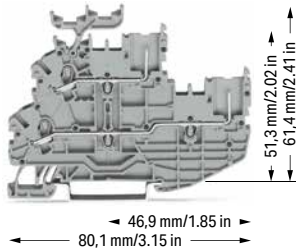

1-conductor/1-pin double-deck carrier terminal block; through/through terminal block; with marker carrier; gray

	Item No.	Pack. Unit
○ L/L	2020-2231	50
○ N/L	2020-2232	50
○ L/N	2020-2233	50

1-conductor/1-pin double-deck carrier terminal block; through/through terminal block; with marker carrier; blue

	Item No.	Pack. Unit
● N/N	2020-2234	50

1-conductor/1-pin double-deck carrier terminal block; ground conductor/through terminal block; with marker carrier; gray

	Item No.	Pack. Unit
○ PE/N	2020-2247	50
○ PE/L	2020-2257	50

1-conductor/1-pin double-deck carrier terminal block; through/through terminal block; without marker carrier; gray

○ L/L	2020-2201	50
○ N/L	2020-2202	50
○ L/N	2020-2203	50

1-conductor/1-pin double-deck carrier terminal block; through/through terminal block; without marker carrier; blue

● N/N	2020-2204	50
-------	-----------	----

1-conductor/1-pin double-deck carrier terminal block; ground conductor/through terminal block; without marker carrier; gray

○ PE/N	2020-2217	50
○ PE/L	2020-2227	50

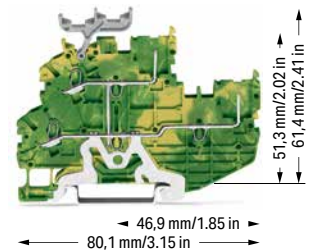
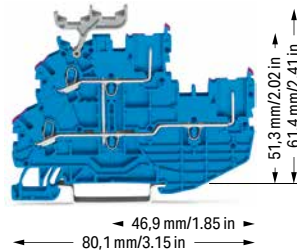
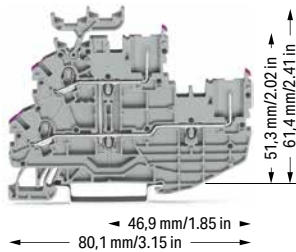

2-conductor/2-pin double-deck carrier terminal block; 2-conductor/2-pin through terminal block; with marker carrier, internally commoned; violet conductor entry; gray

	Item No.	Pack. Unit
○ L	2020-2238	50

2-conductor/2-pin double-deck carrier terminal block; 2-conductor/2-pin through terminal block; with marker carrier, internally commoned; violet conductor entry; blue

	Item No.	Pack. Unit
● N	2020-2239	50

2-conductor/2-pin double-deck carrier block; 2-conductor/2-pin ground conductor block; with marker carrier; internally commoned; green-yellow

	Item No.	Pack. Unit
● PE	2020-2237	50

2-conductor/2-pin double-deck carrier terminal block; 2-conductor/2-pin through terminal block; without marker carrier, internally commoned; violet conductor entry; gray

○ L	2020-2208	50
-----	-----------	----

2-conductor/2-pin double-deck carrier terminal block; 2-conductor/2-pin through terminal block; without marker carrier, internally commoned; violet conductor entry; blue

● N	2020-2209	50
-----	-----------	----

2-conductor/2-pin double-deck carrier block; 2-conductor/2-pin ground conductor block; without marker carrier; internally commoned; green-yellow

● PE	2020-2207	50
------	-----------	----

❶ Conductor range: 0.14 ... 1.5 mm² "s+f-st";
Push-in termination: 0.5 ... 1.5 mm² "s" and
0.5 ... 0.75 mm² "insulated ferrules; 10 mm"
Depending on the conductor characteristic, a conductor
with a smaller cross section can also be inserted
via push-in termination.

❷ 500 V = rated voltage
6 kV = rated impulse voltage
3 = pollution degree
(see Section 15)

❸ Current-carrying capacity curves upon request

Note:

When used as intended, female plugs must not be
connected/disconnected when live or under load.
An appropriate end plate must be applied to the
carrier terminal blocks after each female plug.

Please observe the application notes:
Jumpers, from page 174
Testing accessories, page 173
Marking, from page 640

Approvals and corresponding ratings,
visit www.wago.com

Accessories; 2020 Series

Appropriate marking systems:
WMB/WMB Inline/Marking strips

End and intermediate plate; 1 mm thick

	orange	2020-2292	100 (25)
	gray	2020-2291	100 (25)

Push-in type jumper bar; insulated; I_N 14 A; light gray

	2-way	2000-402	25
	3-way	2000-403	25
	4-way	2000-404	25
	5-way	2000-405	25
	6-way	2000-406	25
	7-way	2000-407	25
	8-way	2000-408	25
	9-way	2000-409	25
	10-way	2000-410	25

Push-in type jumper bar; insulated; I_N 14 A; light gray

	1 to 3	2000-433	25
	1 to 4	2000-434	25
	1 to 5	2000-435	25
	1 to 6	2000-436	25
	1 to 7	2000-437	25
	1 to 8	2000-438	25
	1 to 9	2000-439	25
	1 to 10	2000-440	25

Double-deck vertical jumper; insulated; I_N 13.5 A

	light gray	2000-492	100 (25)
---	------------	----------	----------

**Protective warning marker; with black high-voltage
symbol; for 5 terminal blocks**

	yellow	2000-115	100 (25)
---	--------	----------	----------

Carrier with 6 coding pins; for coding female plugs

	orange	2020-100	100 (25)
---	--------	----------	----------

Test pin; 1 mm Ø

		859-500	1
---	--	---------	---

Accessories; 2020 Series

Appropriate marking systems:
WMB/WMB Inline/Marking strips

Test plug adapter; for 4 mm Ø test plug

	gray	2009-174	100 (25)
---	------	----------	----------

Testing tap; for max. 2.5 mm²

	gray	2009-182	100 (25)
---	------	----------	----------

1-conductor female plug

	gray	2020-102	100
---	------	----------	-----

2-conductor female plug

	gray	2020-202	100
---	------	----------	-----

Marking strip; plain; 11 mm wide; 50 m reel

	white	2009-110	1
---	-------	----------	---

WMB Inline; plain; 2,300 WMB markers (3.5 mm)/reel

	white	2009-113	1
--	-------	----------	---

**WMB marking card; white; 10 strips with 10 markers/card;
for 3.5 mm terminal block width**

	plain	793-3501	5
---	-------	----------	---

Double-deck marker carrier; pivoting

	gray	2000-121	50 (25)
---	------	----------	---------



Size comparison:
Double-deck carrier terminal blocks with 3.5 mm and
5.2 mm terminal block widths

1-Conductor Female Plug, 2-Conductor Female Plug X-COM®S-SYSTEM-MINI

1 (1.5) mm²; 2020 Series

Technical Data	
0.14 ... 1 (1.5) mm ² ❶	24 ... 16 AWG
500 V/6 kV/3 ❷	300 V, 15 A ❸
I _N 13.5 A ❸	300 V, 10 A ❸
Module width: 3.5 mm / 0.138 inch	
9 ... 11 mm / 0.35 ... 0.43 inch	

Technical Data	
0.14 ... 1 (1.5) mm ² ❶	24 ... 16 AWG
500 V/6 kV/3 ❷	300 V, 15 A ❸
I _N 13.5 A ❸	300 V, 10 A ❸
Module width: 3.5 mm / 0.138 inch	
9 ... 11 mm / 0.35 ... 0.43 inch	

- ❶ Conductor range: 0.14 ... 1.5 mm² "s+f-st"; Push-in termination: 0.5 ... 1.5 mm² "s" and 0.5 ... 0.75 mm² "insulated ferrules; 10 mm" Depending on the conductor characteristic, a conductor with a smaller cross section can also be inserted via push-in termination.
- ❷ 500 V = rated voltage
6 kV = rated impulse voltage
3 = pollution degree (see Section 15)
- ❸ Current-carrying capacity curves upon request

Item no. suffixes
 blue .../000-006
 green-yellow .../000-016

Approvals and corresponding ratings, visit www.wago.com



Dimensions (in mm):

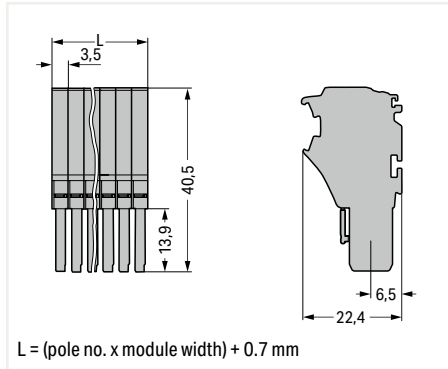

Dimensions (in mm):

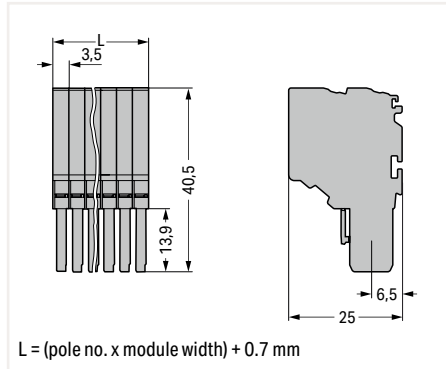

1-conductor female plug; fits into carrier terminal blocks; codable; gray
 According to EN 61984, pluggable connectors without a current interrupting capacity must not be mated or unmated when live or under load.
 Notice: An appropriate end plate must be applied to the carrier terminal blocks after each female plug.

2-conductor female plug; fits into carrier terminal blocks; codable; gray
 According to EN 61984, pluggable connectors without a current interrupting capacity must not be mated or unmated when live or under load.
 Notice: An appropriate end plate must be applied to the carrier terminal blocks after each female plug.

Pole No.	Item No.	Pack. Unit
2	2020-102	100
3	2020-103	50
4	2020-104	50
5	2020-105	50
6	2020-106	50
7	2020-107	25
8	2020-108	25
9	2020-109	25
10	2020-110	25
11	2020-111	20
12	2020-112	20
13	2020-113	10
14	2020-114	10
15	2020-115	10

Pole No.	Item No.	Pack. Unit
2	2020-202	100
3	2020-203	50
4	2020-204	50
5	2020-205	50
6	2020-206	25
7	2020-207	25
8	2020-208	25
9	2020-209	25
10	2020-210	25
11	2020-211	20
12	2020-212	20
13	2020-213	10
14	2020-214	10
15	2020-215	10

Accessories; for female plugs

Appropriate marking systems: WMB/WMB Inline

Protective warning marker; with black high-voltage symbol; for 5 terminal blocks

	yellow	2000-115	100 (25)
--	--------	----------	----------

Locking lever; 4.8 mm wide

	orange	2022-142	100 (25)
	gray	2022-141	100 (25)

Carrier with 6 coding pins; for coding female plugs

	orange	2020-100	100 (25)
--	--------	----------	----------

Locking lever; 9.6 mm wide

	orange	2022-152	100 (25)
	gray	2022-151	100 (25)



X-COM®S-SYSTEM terminal block assembly

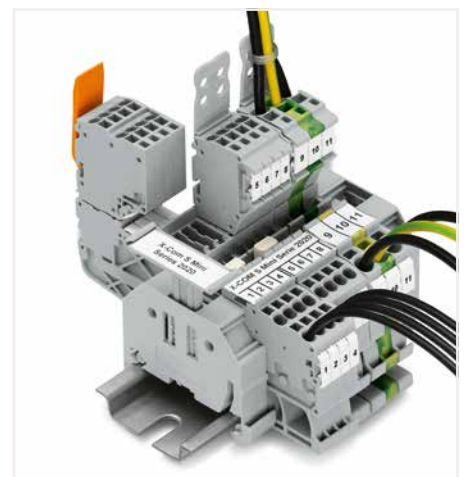

X-COM®S-SYSTEM terminal block assembly

Carrier Terminal Blocks and 1-/2-Conductor Female Plugs X-COM®S-SYSTEM-MINI Types of Assembly

2



1-conductor female plug
Carrier terminal blocks can be commoned via 2000 Series Push-In Type Jumper Bars and tested via 859-500 Test Pin.

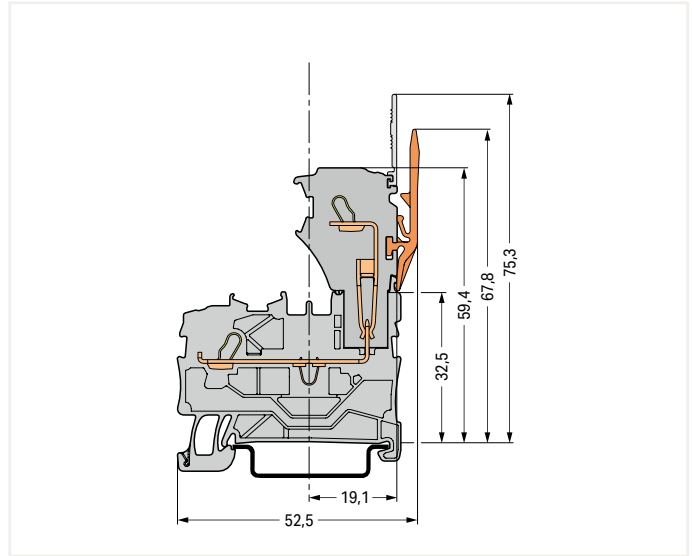

Carrier terminal block

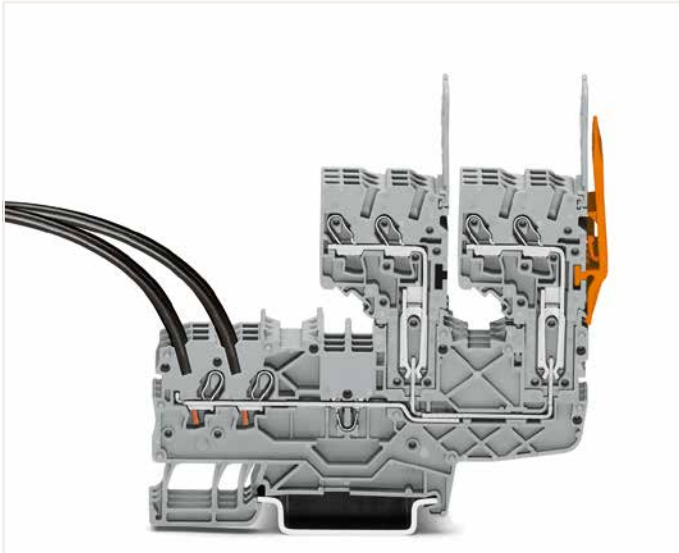

2-conductor female plug
Carrier terminal blocks can be commoned via 2000 Series Push-In Type Jumper Bars and tested via 859-500 Test Pin.

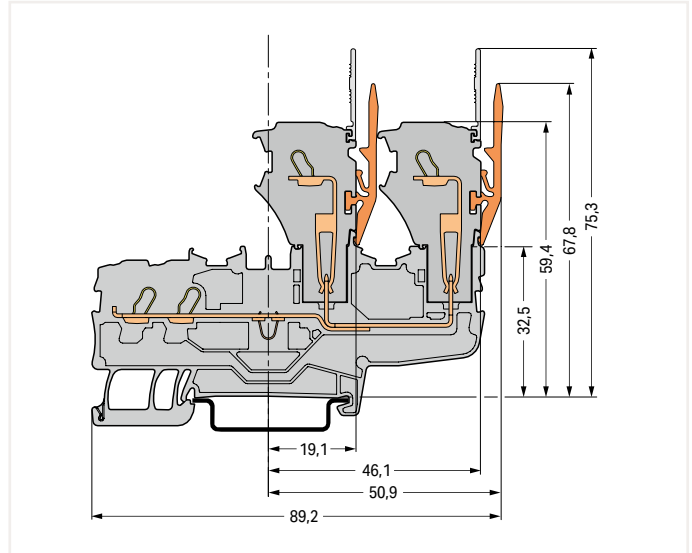

Carrier terminal block

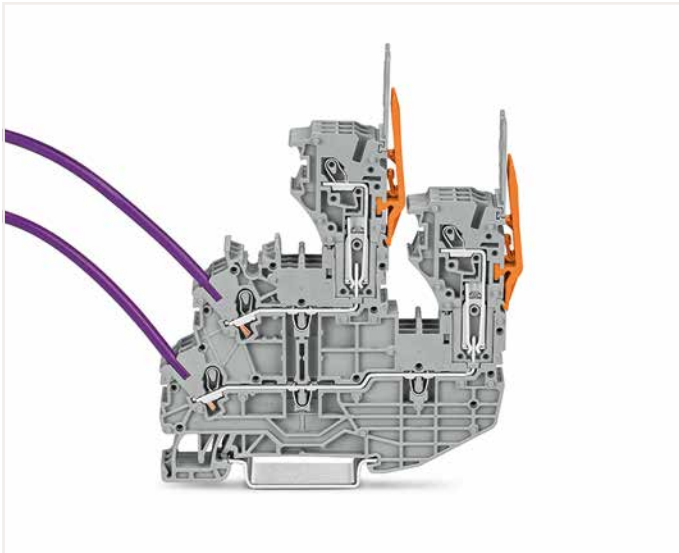

1-conductor female plug
Double-deck carrier terminal blocks can be commoned via 2000 Series Push-In Type Jumper Bars and tested via 859-500 Test Pin.

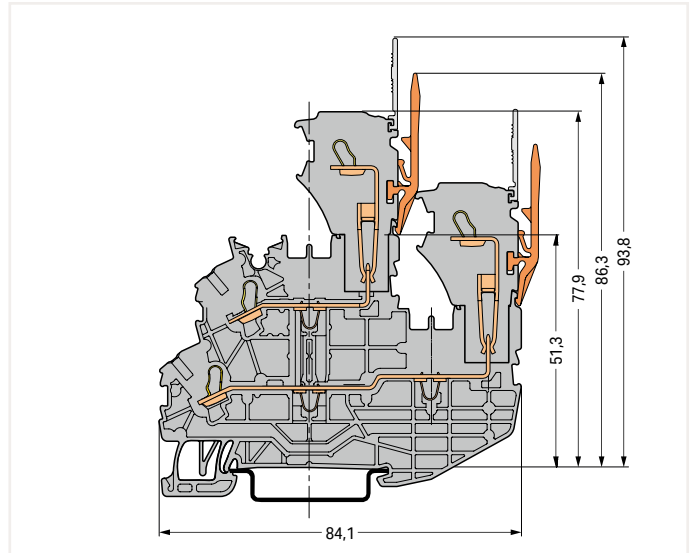

Double-deck carrier terminal block

Female Plug for Self-Assembly X-COM®S-SYSTEM-MINI 1 (1.5) mm²; 2020 Series

Technical Data

0.14 ... 1 (1.5) mm ² ①	24 ... 16 AWG
500 V/6 kV/3 ②	300 V, 15 A ③
I _N 13.5 A ③	300 V, 10 A ④
Terminal block width: 3.5 mm / 0.138 inch	
 9 ... 11 mm / 0.35 ... 0.43 inch	

Technical Data

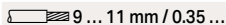
0.14 ... 1 (1.5) mm ² ①	24 ... 16 AWG
500 V/6 kV/3 ②	300 V, 15 A ③
I _N 13.5 A ③	300 V, 10 A ④
Terminal block width: 3.5 mm / 0.138 inch	
 9 ... 11 mm / 0.35 ... 0.43 inch	



① Conductor range: 0.14 ... 1.5 mm² "s+f-st"; Push-in termination: 0.5 ... 1.5 mm² "s" and 0.5 ... 0.75 mm² "insulated ferrules; 10 mm" Depending on the conductor characteristic, a conductor with a smaller cross section can also be inserted via push-in termination.

② 500 V = rated voltage
6 kV = rated impulse voltage
3 = pollution degree (see Section 15)

③ Current-carrying capacity curves upon request



Note:

According to EN 61984, pluggable connectors without a current interrupting capacity must not be mated or unmated when live or under load.



Notice: An appropriate end plate must be applied to the carrier terminal blocks after each female plug.

Approvals and corresponding ratings, visit www.wago.com



1-conductor end module; codable

Color	Item No.	Pack. Unit
 gray	2020-181	250
 blue	2020-184	250
 green-yellow	2020-187	250



2-conductor end module; codable

Color	Item No.	Pack. Unit
 gray	2020-281	250
 blue	2020-284	250
 green-yellow	2020-287	250

1-conductor base module; with end plate; codable

 gray	2020-161	250
 blue	2020-164	250
 green-yellow	2020-167	250

2-conductor base module; with end plate; codable

 gray	2020-261	250
 blue	2020-264	250
 green-yellow	2020-267	250

Accessories; for female plugs

Appropriate marking systems: WMB/WMB Inline

Protective warning marker; with black high-voltage symbol; for 5 terminal blocks

 yellow	2000-115	100 (25)
--	----------	----------

Carrier with 6 coding pins; for coding female plugs

 orange	2020-100	100 (25)
--	----------	----------

Locking lever; 4.8 mm wide

 orange	2022-142	100 (25)
 gray	2022-141	100 (25)

Locking lever; 9.6 mm wide

 orange	2022-152	100 (25)
 gray	2022-151	100 (25)

Strain relief plate; gray

 35 mm wide	734-326	100 (25)
6 mm wide	734-327	100 (25)
12.5 mm wide	734-328	100 (25)
25 mm wide	734-329	100 (25)

WMB Inline; plain; 2,300 WMB markers (3.5 mm)/reel

 white	2009-113	1
--	----------	---

WMB marking card; white; 10 strips with 10 markers/card; for 3.5 mm terminal block width

 plain	793-3501	5
--	----------	---

Customizing Modular Female Plugs

WAGO's modular X-COM®S-SYSTEM female plugs can be customized for applications requiring varying numbers of poles (e.g., when designing prototypes).

Modules and Pole Numbers

A customized X-COM®S-SYSTEM-MINI female plug consists of:

- One base module with end plate
- Up to 14 end modules

Intended Use

According to EN 61984, pluggable connectors without a current interrupting capacity must not be mated or unmated when live or under load.

Mounting

The appropriate mounting tool shall be used in order to guarantee that the individual modules are properly attached to each other without damaging the locking latches.



End module

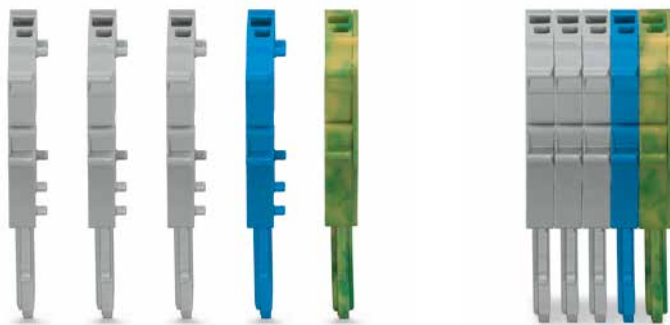

Base module

Example: 5-Pole, 1-Conductor Female Plug

Base module with end plate
2020-167

End module
2020-184

End modules
2020-181

Pre-Assembled 1-Conductor Female Plug X-COM®S-SYSTEM-MINI 1 (1.5) mm²; 2020 Series

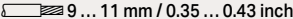
Technical Data	
0.14 ... 1 (1.5) mm ² ①	24 ... 16 AWG
500 V/6 kV/3 ②	300 V, 15 A ④
I _N 13.5 A ③	300 V, 10 A ⑤
Module width: 3.5 mm / 0.138 inch	
	

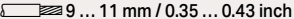
Technical Data	
0.14 ... 1 (1.5) mm ² ①	24 ... 16 AWG
500 V/6 kV/3 ②	300 V, 15 A ④
I _N 13.5 A ③	300 V, 10 A ⑤
Module width: 3.5 mm / 0.138 inch	
	

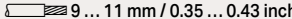
Technical Data	
0.14 ... 1 (1.5) mm ² ①	24 ... 16 AWG
500 V/6 kV/3 ②	300 V, 15 A ④
I _N 13.5 A ③	300 V, 10 A ⑤
Module width: 3.5 mm / 0.138 inch	
	



1-conductor female plug; with ground base module (green-yellow); fits into carrier terminal blocks; codable		
Pole No.	Item No.	Pack. Unit
3	2020-103/000-036	50
4	2020-104/000-036	50
5	2020-105/000-036	50
6	2020-106/000-036	50
7	2020-107/000-036	25
8	2020-108/000-036	25
9	2020-109/000-036	25
10	2020-110/000-036	25
11	2020-111/000-036	20
12	2020-112/000-036	20
13	2020-113/000-036	10
14	2020-114/000-036	10
15	2020-115/000-036	10

1-conductor female plug; with ground end module (green-yellow); fits into carrier terminal blocks; codable		
Pole No.	Item No.	Pack. Unit
3	2020-103/000-037	50
4	2020-104/000-037	50
5	2020-105/000-037	50
6	2020-106/000-037	50
7	2020-107/000-037	25
8	2020-108/000-037	25
9	2020-109/000-037	25
10	2020-110/000-037	25
11	2020-111/000-037	20
12	2020-112/000-037	20
13	2020-113/000-037	10
14	2020-114/000-037	10
15	2020-115/000-037	10

1-conductor female plug; with ground base module (green-yellow); fits into carrier terminal blocks; codable		
Pole No.	Item No.	Pack. Unit
3	2020-103/000-038	50
4	2020-104/000-038	50
5	2020-105/000-038	50
6	2020-106/000-038	50
7	2020-107/000-038	25
8	2020-108/000-038	25
9	2020-109/000-038	25
10	2020-110/000-038	25
11	2020-111/000-038	20
12	2020-112/000-038	20
13	2020-113/000-038	10
14	2020-114/000-038	10
15	2020-115/000-038	10

Accessories; for female plugs

Appropriate marking systems: WMB/WMB Inline/Marking strips



Protective warning marker; with black high-voltage symbol; for 5 terminal blocks

	yellow	2000-115	100 (25)
---	--------	----------	----------



Carrier with 6 coding pins; for coding female plugs

	orange	2020-100	100 (25)
---	--------	----------	----------





Locking lever; 4.8 mm wide

	orange	2022-142	100 (25)
	gray	2022-141	100 (25)

Locking lever; 9.6 mm wide

	orange	2022-152	100 (25)
	gray	2022-151	100 (25)

Strain relief plate; gray

	35 mm wide	734-326	100 (25)
	6 mm wide	734-327	100 (25)
	12.5 mm wide	734-328	100 (25)
	25 mm wide	734-329	100 (25)

Marking strip; plain; 11 mm wide; 50 m reel

	white	2009-110	1
---	-------	----------	---

WMB Inline; plain; 2,300 WMB markers (3.5 mm)/reel

	white	2009-113	1
---	-------	----------	---

WMB marking card; white; 10 strips with 10 markers/card; for 3.5 mm terminal block width

	plain	793-3501	5
---	-------	----------	---

Technical Data

0.14 ... 1 (1.5) mm² ① | 24 ... 16 AWG

500 V/6 kV/3 ② | 300 V, 15 A ③

I_N 13.5 A ③ | 300 V, 10 A ③

Module width: 3.5 mm / 0.138 inch

9 ... 11 mm / 0.35 ... 0.43 inch



1-conductor female plug; with ground end module (green-yellow); fits into carrier terminal blocks; codable

Pole No.	Item No.	Pack. Unit
3	2020-103/000-039	50
4	2020-104/000-039	50
5	2020-105/000-039	50
6	2020-106/000-039	50
7	2020-107/000-039	25
8	2020-108/000-039	25
9	2020-109/000-039	25
10	2020-110/000-039	25
11	2020-111/000-039	20
12	2020-112/000-039	20
13	2020-113/000-039	10
14	2020-114/000-039	10
15	2020-115/000-039	10

① Conductor range: 0.14 ... 1.5 mm² "s+f-st";
Push-in termination: 0.5 ... 1.5 mm² "s" and
0.5 ... 0.75 mm² "insulated ferrules; 10 mm"
Depending on the conductor characteristic, a conductor
with a smaller cross section can also be inserted
via push-in termination.

② 500 V = rated voltage
6 kV = rated impulse voltage
3 = pollution degree
(see Section 15)

③ Current-carrying capacity curves upon request

Note:

According to EN 61984, pluggable connectors without
a current interrupting capacity must not be mated or
unmated when live or under load.

Notice: An appropriate end plate must be applied to
the carrier terminal blocks after each female plug.

Approvals and corresponding ratings,
visit www.wago.com

Pre-Assembled 2-Conductor Female Plug X-COM®S-SYSTEM-MINI 1 (1.5) mm²; 2020 Series

Technical Data	
0.14 ... 1 (1.5) mm ² ①	24 ... 16 AWG
500 V/6 kV/3 ②	300 V, 15 A ③
I _N 13.5 A ④	300 V, 10 A ⑤
Module width: 3.5 mm / 0.138 inch	
9 ... 11 mm / 0.35 ... 0.43 inch	

Technical Data	
0.14 ... 1 (1.5) mm ² ①	24 ... 16 AWG
500 V/6 kV/3 ②	300 V, 15 A ③
I _N 13.5 A ④	300 V, 10 A ⑤
Module width: 3.5 mm / 0.138 inch	
9 ... 11 mm / 0.35 ... 0.43 inch	

Technical Data	
0.14 ... 1 (1.5) mm ² ①	24 ... 16 AWG
500 V/6 kV/3 ②	300 V, 15 A ③
I _N 13.5 A ④	300 V, 10 A ⑤
Module width: 3.5 mm / 0.138 inch	
9 ... 11 mm / 0.35 ... 0.43 inch	



2-conductor female plug; with ground base module (green-yellow); fits into carrier terminal blocks; codable		
Pole No.	Item No.	Pack. Unit
3	2020-203/000-036	50
4	2020-204/000-036	50
5	2020-205/000-036	50
6	2020-206/000-036	50
7	2020-207/000-036	25
8	2020-208/000-036	25
9	2020-209/000-036	25
10	2020-210/000-036	25
11	2020-211/000-036	20
12	2020-212/000-036	20
13	2020-213/000-036	10
14	2020-214/000-036	10
15	2020-215/000-036	10

2-conductor female plug; with ground end module (green-yellow); fits into carrier terminal blocks; codable		
Pole No.	Item No.	Pack. Unit
3	2020-203/000-037	50
4	2020-204/000-037	50
5	2020-205/000-037	50
6	2020-206/000-037	50
7	2020-207/000-037	25
8	2020-208/000-037	25
9	2020-209/000-037	25
10	2020-210/000-037	25
11	2020-211/000-037	20
12	2020-212/000-037	20
13	2020-213/000-037	10
14	2020-214/000-037	10
15	2020-215/000-037	10

2-conductor female plug; with ground base module (green-yellow); fits into carrier terminal blocks; codable		
Pole No.	Item No.	Pack. Unit
3	2020-203/000-038	50
4	2020-204/000-038	50
5	2020-205/000-038	50
6	2020-206/000-038	50
7	2020-207/000-038	25
8	2020-208/000-038	25
9	2020-209/000-038	25
10	2020-210/000-038	25
11	2020-211/000-038	20
12	2020-212/000-038	20
13	2020-213/000-038	10
14	2020-214/000-038	10
15	2020-215/000-038	10

Accessories; for female plugs

Appropriate marking systems: WMB/WMB Inline

Protective warning marker; with black high-voltage symbol; for 5 terminal blocks



yellow 2000-115 100 (25)

Carrier with 6 coding pins; for coding female plugs



orange 2020-100 100 (25)

Locking lever; 4,8 mm wide



orange 2022-142 100 (25)

gray 2022-141 100 (25)

Locking lever; 9,6 mm wide



orange 2022-152 100 (25)

gray 2022-151 100 (25)

Strain relief plate; gray



35 mm wide 734-326 100 (25)

6 mm wide 734-327 100 (25)

12.5 mm wide 734-328 100 (25)

25 mm wide 734-329 100 (25)

WMB Inline; plain; 2,300 WMB markers (3.5 mm)/reel



white 2009-113 1

WMB marking card; white; 10 strips with 10 markers/card; for 3.5 mm terminal block width



plain 793-3501 5

Technical Data

0.14 ... 1 (1.5) mm ² ①	24 ... 16 AWG
500 V/6 kV/3 ②	300 V, 15 A ③
I _N 13.5 A ③	300 V, 10 A ③
Module width: 3.5 mm / 0.138 inch	
9 ... 11 mm / 0.35 ... 0.43 inch	

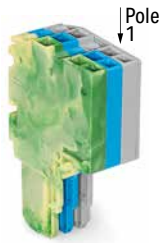

2-conductor female plug; with ground end module (green-yellow); fits into carrier terminal blocks; codable

Pole No.	Item No.	Pack. Unit
3	2020-203/000-039	50
4	2020-204/000-039	50
5	2020-205/000-039	50
6	2020-206/000-039	50
7	2020-207/000-039	25
8	2020-208/000-039	25
9	2020-209/000-039	25
10	2020-210/000-039	25
11	2020-211/000-039	20
12	2020-212/000-039	20
13	2020-213/000-039	10
14	2020-214/000-039	10
15	2020-215/000-039	10

① Conductor range: 0.14 ... 1.5 mm² "s+f-st";
Push-in termination: 0.5 ... 1.5 mm² "s" and
0.5 ... 0.75 mm² "insulated ferrules; 10 mm"
Depending on the conductor characteristic, a conductor
with a smaller cross section can also be inserted
via push-in termination.

② 500 V = rated voltage
6 kV = rated impulse voltage
3 = pollution degree
(see Section 15)

③ Current-carrying capacity curves upon request

Note:

According to EN 61984, pluggable connectors without
a current interrupting capacity must not be mated or
unmated when live or under load.

Notice: An appropriate end plate must be applied to
the carrier terminal blocks after each female plug.

Approvals and corresponding ratings,
visit www.wago.com

1-Conductor Female Plug X-COM®S-SYSTEM-MINI; with Lateral Locking Lever and Strain Relief Plate

1 (1.5) mm²; 2020 Series

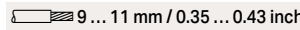
Technical Data	
0.14 ... 1 (1.5) mm ² ①	24 ... 16 AWG
500 V/6 kV/3 ②	300 V, 15 A ③
I _N 13.5 A ④	300 V, 10 A ⑤
Module width: 3.5 mm / 0.138 inch	
	

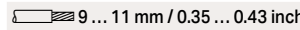
Technical Data	
0.14 ... 1 (1.5) mm ² ①	24 ... 16 AWG
500 V/6 kV/3 ②	300 V, 15 A ③
I _N 13.5 A ④	300 V, 10 A ⑤
Module width: 3.5 mm / 0.138 inch	
	

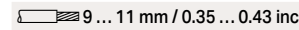
Technical Data	
0.14 ... 1 (1.5) mm ² ①	24 ... 16 AWG
500 V/6 kV/3 ②	300 V, 15 A ③
I _N 13.5 A ④	300 V, 10 A ⑤
Module width: 3.5 mm / 0.138 inch	
	



1-conductor female plug; with locking lever; fits into carrier terminal blocks; codable; gray

Pole No.	Item No.	Pack. Unit
○ 2	2020-102/122-000	100
○ 3	2020-103/122-000	50
○ 4	2020-104/124-000	50
○ 5	2020-105/124-000	50
○ 6	2020-106/124-000	25
○ 7	2020-107/124-000	25
○ 8	2020-108/124-000	25
○ 9	2020-109/124-000	25
○ 10	2020-110/125-000	25
○ 11	2020-111/125-000	20
○ 12	2020-112/125-000	20
○ 13	2020-113/125-000	10
○ 14	2020-114/125-000	10
○ 15	2020-115/125-000	10

1-conductor female plug; with strain relief plate; fits into carrier terminal blocks; codable; gray

Pole No.	Item No.	Pack. Unit
○ 2	2020-102/132-000	100
○ 3	2020-103/132-000	50
○ 4	2020-104/133-000	50
○ 5	2020-105/133-000	50
○ 6	2020-106/133-000	25
○ 7	2020-107/134-000	25
○ 8	2020-108/134-000	25
○ 9	2020-109/134-000	25
○ 10	2020-110/135-000	25
○ 11	2020-111/135-000	20
○ 12	2020-112/135-000	20
○ 13	2020-113/135-000	10
○ 14	2020-114/135-000	10
○ 15	2020-115/135-000	10

1-conductor female plug; with strain relief plate and locking lever; fits into carrier terminal blocks; codable; gray

Pole No.	Item No.	Pack. Unit
○ 2	2020-102/142-000	100
○ 3	2020-103/142-000	50
○ 4	2020-104/143-000	50
○ 5	2020-105/143-000	50
○ 6	2020-106/143-000	25
○ 7	2020-107/144-000	25
○ 8	2020-108/144-000	25
○ 9	2020-109/144-000	25
○ 10	2020-110/145-000	25
○ 11	2020-111/145-000	20
○ 12	2020-112/145-000	20
○ 13	2020-113/145-000	10
○ 14	2020-114/145-000	10
○ 15	2020-115/145-000	10

Accessories; for female plugs

Appropriate marking systems: WMB/WMB Inline/Marking strips

Protective warning marker; with black high-voltage symbol; for 5 terminal blocks

	yellow	2000-115	100 (25)
---	--------	----------	----------

Carrier with 6 coding pins; for coding female plugs

	orange	2020-100	100 (25)
---	--------	----------	----------

Marking strip; plain; 11 mm wide; 50 m reel

	white	2009-110	1
---	-------	----------	---

WMB Inline; plain; 2,300 WMB markers (3.5 mm)/reel

	white	2009-113	1
---	-------	----------	---

WMB marking card; white; 10 strips with 10 markers/card; for 3.5 mm terminal block width

	plain	793-3501	5
--	-------	----------	---

❶ Conductor range: 0.14 ... 1.5 mm² "s+f-st";
 Push-in termination: 0.5 ... 1.5 mm² "s" and
 0.5 ... 0.75 mm² "insulated ferrules; 10 mm"
 Depending on the conductor characteristic, a conductor
 with a smaller cross section can also be inserted
 via push-in termination.

❷ 500 V = rated voltage
 6 kV = rated impulse voltage
 3 = pollution degree
 (see Section 15)

❸ Current-carrying capacity curves upon request

Note:
 According to EN 61984, pluggable connectors without
 a current interrupting capacity must not be mated or
 unmated when live or under load.
 Notice: An appropriate end plate must be applied to
 the carrier terminal blocks after each female plug.

Approvals and corresponding ratings,
 visit www.wago.com

Strain Relief Plate (SRP), Gray				Locking Lever (LL), Gray				SRP and LL, Gray
Assembled				Assembled				Assembled
SRP				Pole No.	Quantity	1-Way	2-Way	
Item No. Suffix				Item No. Suffix				Item No. Suffix
Item No.	Color	Width						
734-327	gray	6mm	/132-0xx	2 to 3	1	/122-0xx	-	/142-0xx
734-328	gray	12.5mm	/133-0xx	4 to 6	1	-	/124-0xx	/143-0xx
734-329	gray	25mm	/134-0xx	7 to 9	1	-	/124-0xx	/144-0xx
734-326	gray	35mm	/135-0xx	10 to 15	2	-	/125-0xx	/145-0xx

For colored female plugs, the item number suffix "xx" must be replaced by the blue "-006" and the green-yellow "-016" color suffix.

Dimensions of locking levers

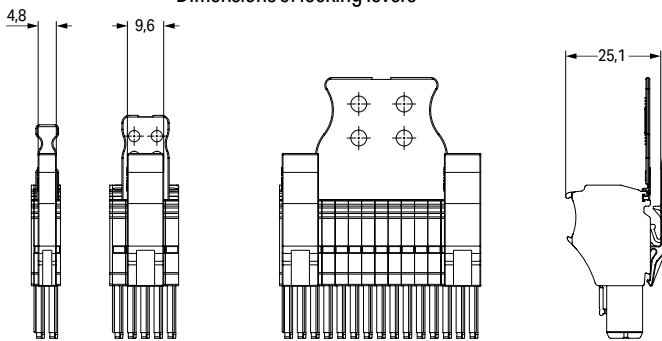

Description	Color	Item No.	Suffix No.
1-conductor female plug	gray	2020-102	none
2- to 15-pole	blue green-yellow	to 2020-115	/000-006 /000-016

Dimensions of strain relief plates

2-Conductor Female Plug X-COM®S-SYSTEM-MINI; with Lateral Locking Lever and Strain Relief Plate

1 (1.5) mm²; 2020 Series

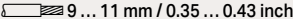
Technical Data	
0.14 ... 1 (1.5) mm ² ①	24 ... 16 AWG
500 V/6 kV/3 ②	300 V, 15 A ③
I _N 13.5 A ④	300 V, 10 A ⑤
Module width: 3.5 mm / 0.138 inch	
	

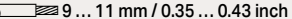
Technical Data	
0.14 ... 1 (1.5) mm ² ①	24 ... 16 AWG
500 V/6 kV/3 ②	300 V, 15 A ③
I _N 13.5 A ④	300 V, 10 A ⑤
Module width: 3.5 mm / 0.138 inch	
	

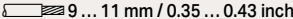
Technical Data	
0.14 ... 1 (1.5) mm ² ①	24 ... 16 AWG
500 V/6 kV/3 ②	300 V, 15 A ③
I _N 13.5 A ④	300 V, 10 A ⑤
Module width: 3.5 mm / 0.138 inch	
	



2-conductor female plug; with locking lever; fits into carrier terminal blocks; codable; gray

Pole No.	Item No.	Pack. Unit
○ 2	2020-202/122-000	100
○ 3	2020-203/122-000	50
○ 4	2020-204/124-000	50
○ 5	2020-205/124-000	50
○ 6	2020-206/124-000	25
○ 7	2020-207/124-000	25
○ 8	2020-208/124-000	25
○ 9	2020-209/124-000	25
○ 10	2020-210/125-000	25
○ 11	2020-211/125-000	20
○ 12	2020-212/125-000	20
○ 13	2020-213/125-000	10
○ 14	2020-214/125-000	10
○ 15	2020-215/125-000	10

2-conductor female plug; with strain relief plate; fits into carrier terminal blocks; codable; gray

Pole No.	Item No.	Pack. Unit
○ 2	2020-202/132-000	100
○ 3	2020-203/132-000	50
○ 4	2020-204/133-000	50
○ 5	2020-205/133-000	50
○ 6	2020-206/133-000	25
○ 7	2020-207/134-000	25
○ 8	2020-208/134-000	25
○ 9	2020-209/134-000	25
○ 10	2020-210/135-000	25
○ 11	2020-211/135-000	20
○ 12	2020-212/135-000	20
○ 13	2020-213/135-000	10
○ 14	2020-214/135-000	10
○ 15	2020-215/135-000	10

2-conductor female plug; with strain relief plate and locking lever; fits into carrier terminal blocks; codable; gray

Pole No.	Item No.	Pack. Unit
○ 2	2020-202/142-000	100
○ 3	2020-203/142-000	50
○ 4	2020-204/143-000	50
○ 5	2020-205/143-000	50
○ 6	2020-206/143-000	25
○ 7	2020-207/144-000	25
○ 8	2020-208/144-000	25
○ 9	2020-209/144-000	25
○ 10	2020-210/145-000	25
○ 11	2020-211/145-000	20
○ 12	2020-212/145-000	20
○ 13	2020-213/145-000	10
○ 14	2020-214/145-000	10
○ 15	2020-215/145-000	10

Accessories; for female plugs

Appropriate marking systems: WMB/WMB Inline

Protective warning marker; with black high-voltage symbol; for 5 terminal blocks

	yellow	2000-115	100 (25)
---	--------	----------	----------

Carrier with 6 coding pins; for coding female plugs

	orange	2020-100	100 (25)
---	--------	----------	----------

WMB Inline; plain; 2,300 WMB markers (3.5 mm)/reel

	white	2009-113	1
---	-------	----------	---

WMB marking card; white; 10 strips with 10 markers/card; for 3.5 mm terminal block width

	plain	793-3501	5
--	-------	----------	---

❶ Conductor range: 0.14 ... 1.5 mm² "s+f-st";
 Push-in termination: 0.5 ... 1.5 mm² "s" and
 0.5 ... 0.75 mm² "insulated ferrules; 10 mm"
 Depending on the conductor characteristic, a conductor
 with a smaller cross section can also be inserted
 via push-in termination.

❷ 500 V = rated voltage
 6 kV = rated impulse voltage
 3 = pollution degree
 (see Section 15)

❸ Current-carrying capacity curves upon request

Note:
 According to EN 61984, pluggable connectors without
 a current interrupting capacity must not be mated or
 unmated when live or under load.
 Notice: An appropriate end plate must be applied to
 the carrier terminal blocks after each female plug.

Approvals and corresponding ratings,
 visit www.wago.com

Strain Relief Plate (SRP), Gray				Locking Lever (LL), Gray				SRP and LL, Gray
Assembled				Assembled				Assembled
SRP				Pole No.	Quantity	1-Way	2-Way	
Item No. Suffix				Item No. Suffix				Item No. Suffix
Item No.	Color	Width						
734-327	gray	6mm	/132-0xx	2 to 3	1	/122-0xx	-	/142-0xx
734-328	gray	12.5mm	/133-0xx	4 to 6	1	-	/124-0xx	/143-0xx
734-329	gray	25mm	/134-0xx	7 to 9	1	-	/124-0xx	/144-0xx
734-326	gray	35mm	/135-0xx	10 to 15	2	-	/125-0xx	/145-0xx

For colored female plugs, the item number suffix "xx" must be replaced by the blue "-006" and the green-yellow "-016" color suffix.

Dimensions of locking levers

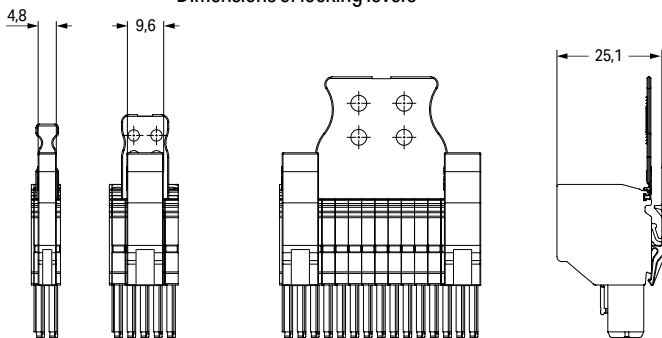

Description	Color	Item No.	Suffix No.
2-conductor female plug	gray	2020-202	none
2- to 15-pole	blue	to	/000-006
	green-yellow	2020-215	/000-016

Dimensions of strain relief plates

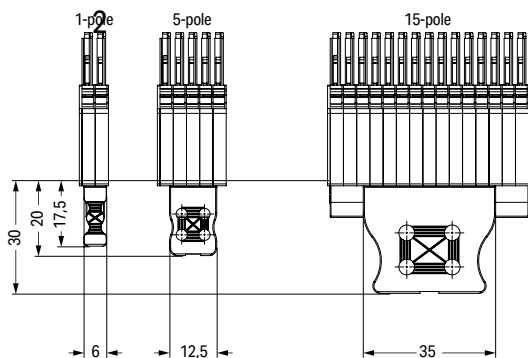

1-Conductor/1-Pin Carrier Terminal Block, 2-Conductor/1-Pin Carrier Terminal Block, 2-Conductor/2-Pin Carrier Terminal Block X-COM®S-SYSTEM 2.5 (4) mm²; 2022 Series

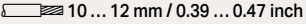
Technical Data	
0.25 ... 2.5 (4) mm ² ①	22 ... 12 AWG
690 V/6 kV/3 ②	600 V, 20 A ③
I _N 24 A (32 A) ④	600 V, 20 A ⑤
Terminal block width: 5.2 mm / 0.205 inch	
 10 ... 12 mm / 0.39 ... 0.47 inch	

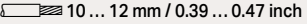
Technical Data	
0.25 ... 2.5 (4) mm ² ①	22 ... 12 AWG
690 V/6 kV/3 ②	600 V, 20 A ③
I _N 24 A (32 A) ④	600 V, 20 A ⑤
Terminal block width: 5.2 mm / 0.205 inch	
 10 ... 12 mm / 0.39 ... 0.47 inch	

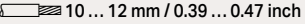
Technical Data	
0.25 ... 2.5 (4) mm ² ①	22 ... 12 AWG
690 V/6 kV/3 ②	600 V, 20 A ③
I _N 24 A (28 A) ④	600 V, 20 A ⑤
Terminal block width: 5.2 mm / 0.205 inch	
 10 ... 12 mm / 0.39 ... 0.47 inch	

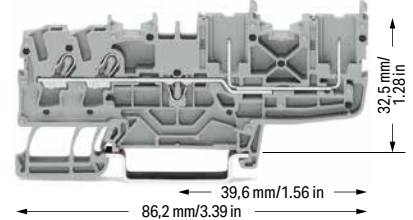
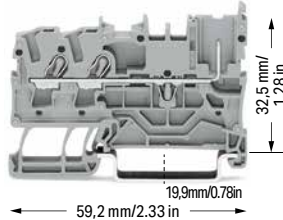
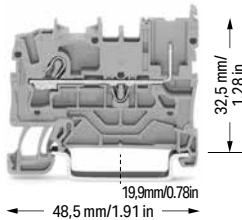

1-conductor/1-pin carrier terminal block		
Color	Item No.	Pack. Unit
gray	2022-1201	100
blue	2022-1204	100
orange	2022-1202	100

2-conductor/1-pin carrier terminal block		
Color	Item No.	Pack. Unit
gray	2022-1301	100
blue	2022-1304	100
orange	2022-1302	100

2-conductor/2-pin carrier terminal block		
Color	Item No.	Pack. Unit
gray	2022-1401	50
blue	2022-1404	50
orange	2022-1402	50

1-conductor/1-pin ground carrier terminal block		
green-yellow	2022-1207	100

2-conductor/1-pin ground carrier terminal block		
green-yellow	2022-1307	100

2-conductor/2-pin ground carrier terminal block		
green-yellow	2022-1407	50

Accessories; item-specific			
End and intermediate plate; 1 mm thick			
orange	2022-1292	100 (25)	
gray	2022-1291	100 (25)	

Accessories; item-specific			
End and intermediate plate; 1 mm thick			
orange	2022-1392	100 (25)	
gray	2022-1391	100 (25)	

Accessories; item-specific			
End and intermediate plate; 1 mm thick			
orange	2022-1492	100 (25)	
gray	2022-1491	100 (25)	

Accessories; 2022 Series

Appropriate marking systems: WMB/WMB Inline/Marking strips

Insulation stop; 5 pcs/strip; 0.25 ... 0.5 mm ²			
light gray	2002-171	200 (25)	

Delta jumper; insulated; I _N = I _N terminal block; light gray			
1-2 3-4 5-6	2002-406/020-000	25	

Push-in type wire jumper; insulated; 1.5 mm ² conductor cross-section; I _N 18 A			
L = 60 mm	2009-412	100 (10)	
L = 110 mm	2009-414	100 (10)	
L = 250 mm	2009-416	100 (10)	

Insulation stop; 5 pcs/strip; 0.75 ... 1 mm ²			
dark gray	2002-172	200 (25)	

Star point jumper; insulated; I _N = I _N terminal block; light gray			
1-3-5	2002-405/011-000	25	

Carrier with 6 coding pins; for coding female plugs			
orange	2022-100	100 (25)	

Protective warning marker; with black high-voltage symbol; for 5 terminal blocks			
yellow	2002-115	100 (25)	

Staggered jumper; insulated; I _N 25 A; light gray			
2-way	2002-472	25	
3-way	2002-473	25	
4-way	2002-474	25	
5-way	2002-475	25	
6-way	2002-476	25	
7-way	2002-477	25	
8-way	2002-478	25	
9-way	2002-479	25	
10-way	2002-480	25	
11-way	2002-481	25	
12-way	2002-482	25	

Test pin; 1 mm Ø			
	859-500	1	

Push-in type jumper bar; insulated; I _N 25 A; light gray			
2-way	2002-402	25	
3-way	2002-403	25	
4-way	2002-404	25	
5-way	2002-405	25	
6-way	2002-406	25	
7-way	2002-407	25	
8-way	2002-408	25	
9-way	2002-409	25	
10-way	2002-410	25	

Adjacent jumper for continuous commoning; insulated; I _N 25 A, light gray			
2-way	2002-400	25	

1-conductor female plug			
gray	2022-101	200	

Push-in type jumper bar; insulated; I _N 25 A; light gray			
1 to 3	2002-433	25	
1 to 4	2002-434	25	
1 to 5	2002-435	25	
1 to 6	2002-436	25	
1 to 7	2002-437	25	
1 to 8	2002-438	25	
1 to 9	2002-439	25	
1 to 10	2002-440	25	

Adjacent jumper for continuous commoning; insulated; I _N 25 A; 1 to 3			
light gray	2002-423	25	
red	2002-423/000-005	25	
blue	2002-423/000-006	25	

Marking strip; plain; 11 mm wide; 50 m reel			
white	2009-110	1	

WMB Inline, plain; 1,500 WMB markers (5 mm)/reel; 5 ... 5.2 mm stretchable			
white	2009-115	1	

WMB marking card; white; 10 strips with 10 markers/card; 5 ... 5.2 mm stretchable			
plain	793-5501	5	

❶ Conductor range: 0.25 ... 4 mm² "s+f-st";
Push-in termination: 1 ... 4 mm² "s" and 1 ... 2.5 mm²
"insulated ferrules, 12 mm"
Depending on the conductor characteristic, a conductor with a smaller cross section can also be inserted via push-in termination.

❷ 690 V = rated voltage
6 kV = rated impulse voltage
3 = pollution degree

❸ Current-carrying capacity curves upon request

Note:

When used as intended, female plugs must not be connected/disconnected when live or under load.

Please observe the application notes:
Jumpers, from page 174
Marking, from page 640

Approvals and corresponding ratings,
visit www.wago.com

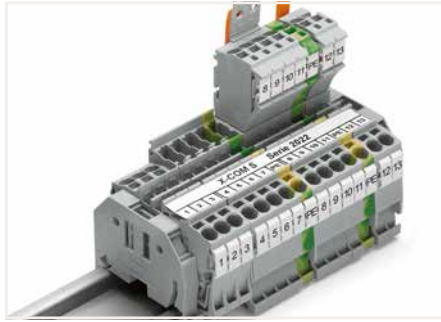

2022 Series X-COM®S-SYSTEM Carrier Terminal Blocks combined with 2002 Series Through Terminal Blocks



Carrier terminal blocks and female plugs are touch-proof.

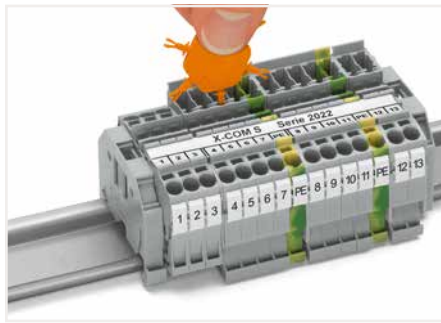

Insert coding pin into the corresponding slot and twist it off.



2-Pin Carrier Terminal Block, 4-Pin Carrier Terminal Block X-COM®S-SYSTEM 2022 Series

Technical Data

690 V/6 kV/3 ①

I_N 24 A (28 A) ②

Terminal block width: 5.2 mm / 0.205 inch

Technical Data

690 V/6 kV/3 ①

I_N 24 A (27 A) ②

Terminal block width: 5.2 mm / 0.205 inch

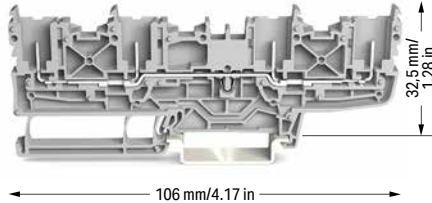
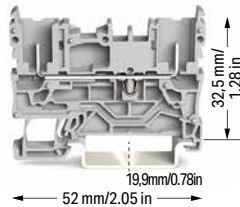

2-pin carrier terminal block

Color	Item No.	Pack. Unit
gray	2022-1601	50
blue	2022-1604	50

2-pin ground carrier terminal block

green-yellow	2022-1607	50
--------------	-----------	----

4-pin carrier terminal block

Color	Item No.	Pack. Unit
gray	2022-1801	50
blue	2022-1804	50

4-pin ground carrier terminal block

green-yellow	2022-1807	50
--------------	-----------	----

Item-Specific Accessories

End plate; 1 mm thick

orange	2022-1692	100 (25)
gray	2022-1691	100 (25)

Item-Specific Accessories

End plate; 1 mm thick

orange	2022-1892	100 (25)
gray	2022-1891	100 (25)

Accessories; 2022 Series

Appropriate marking systems: WMB/WMB Inline/Marking strips

Push-in type jumper bar; insulated; I_N 25 A; light gray

2-way	2002-402	25
3-way	2002-403	25
4-way	2002-404	25
5-way	2002-405	25
6-way	2002-406	25
7-way	2002-407	25
8-way	2002-408	25
9-way	2002-409	25
10-way	2002-410	25

Push-in type jumper bar; insulated; I_N 25 A; light gray

1 to 3	2002-433	25
1 to 4	2002-434	25
1 to 5	2002-435	25
1 to 6	2002-436	25
1 to 7	2002-437	25
1 to 8	2002-438	25
1 to 9	2002-439	25
1 to 10	2002-440	25

Delta jumper; insulated; I_N = I_N terminal block; light gray

1-2 3-4 5-6	2002-406/020-000	25
-------------	------------------	----

Star point jumper; insulated; I_N = I_N terminal block; light gray

1-3-5	2002-405/011-000	25
-------	------------------	----

Adjacent jumper for continuous commoning; insulated; I_N 25 A, light gray

2-way	2002-400	25
-------	----------	----

Staggered jumper; insulated; I_N 25 A; light gray

2-way	2002-472	25
3-way	2002-473	25
4-way	2002-474	25
5-way	2002-475	25
6-way	2002-476	25
7-way	2002-477	25
8-way	2002-478	25
9-way	2002-479	25
10-way	2002-480	25
11-way	2002-481	25
12-way	2002-482	25

Adjacent jumper for continuous commoning; insulated; I_N 25 A; 1 to 3

light gray	2002-423	25
red	2002-423/000-005	25
blue	2002-423/000-006	25

Push-in type wire jumper; insulated; 1.5 mm² conductor cross-section; I_N 18 A

L = 60 mm	2009-412	100 (10)
L = 110 mm	2009-414	100 (10)
L = 250 mm	2009-416	100 (10)

Carrier with 6 coding pins; for coding female plugs

orange	2022-100	100 (25)
--------	----------	----------

1-conductor female plug

gray	2022-101	200
------	----------	-----

① 690 V = rated voltage

6 kV = rated impulse voltage
3 = pollution degree

② Current-carrying capacity curves upon request

Note:

When used as intended, female plugs must not be connected/disconnected when live or under load.

Please observe the application notes:

Jumpers, from page 174

Marking, from page 640

Approvals and corresponding ratings, visit www.wago.com

Accessories; 2022 Series

Appropriate marking systems:
WMB/WMB Inline/Marking strips

Marking strip; plain; 11 mm wide; 50 m reel

white	2009-110	1
-------	----------	---

WMB Inline, plain; 1,500 WMB markers (5 mm)/reel; 5 ... 5.2 mm stretchable

white	2009-115	1
-------	----------	---

WMB marking card; white; 10 strips with 10 markers/card; 5 ... 5.2 mm stretchable

plain	793-5501	5
-------	----------	---

Carrier Terminal Blocks and 1-Conductor Female Plugs X-COM®S-SYSTEM

Types of Assembly

2

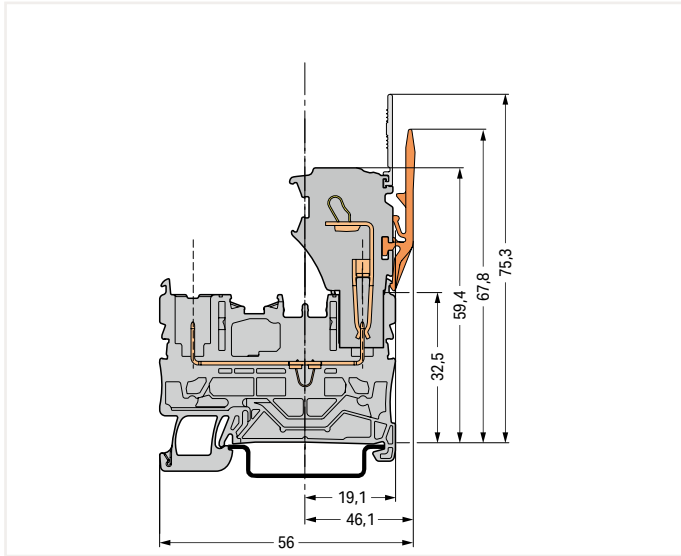

Carrier terminal block

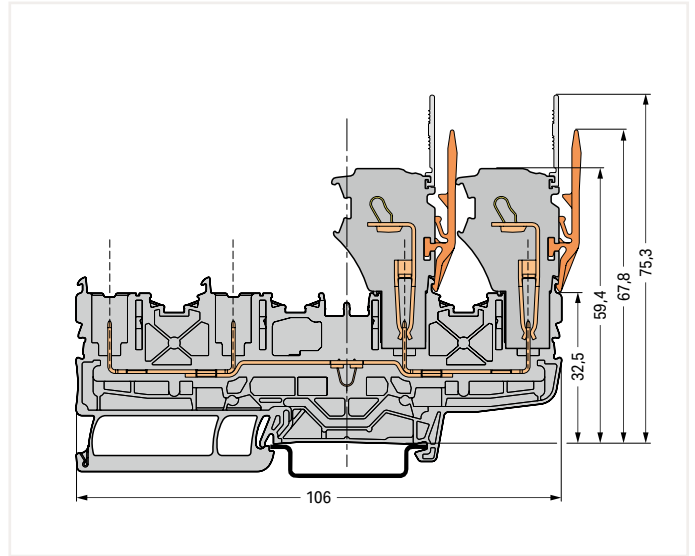

Carrier terminal block

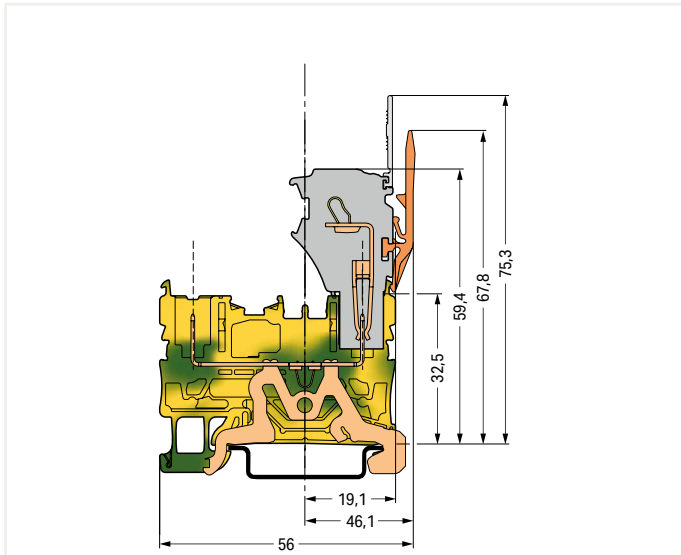

Ground carrier terminal block

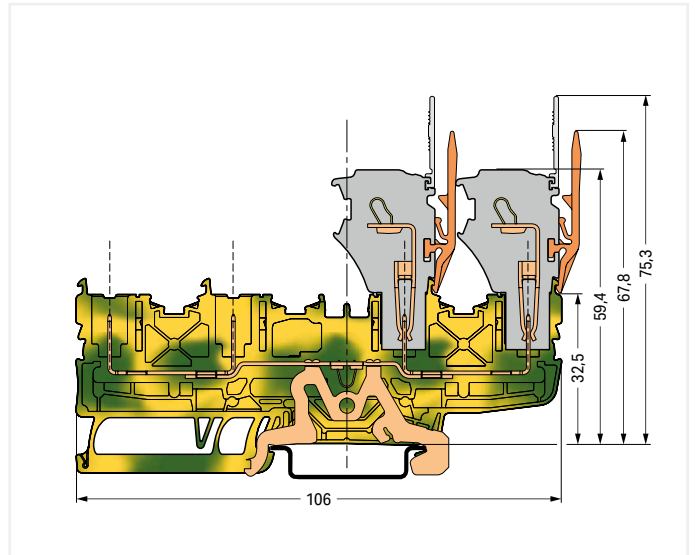

Ground carrier terminal block

1-Conductor/1-Pin Double-Deck Carrier Terminal Block X-COM®S-SYSTEM

2.5 (4) mm²; 2022 Series

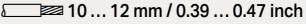
Technical Data	
0.25 ... 2.5 (4) mm ² ①	22 ... 12 AWG
690 V/6 kV/3 ②	600 V, 20 A ③
I _N 24 A (28 A) ④	600 V, 20 A ⑤
Terminal block width: 5.2 mm / 0.205 inch	
 10 ... 12 mm / 0.39 ... 0.47 inch	

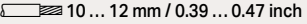
Technical Data	
0.25 ... 2.5 (4) mm ² ①	22 ... 12 AWG
690 V/6 kV/3 ②	600 V, 20 A ③
I _N 24 A (28 A) ④	600 V, 20 A ⑤
Terminal block width: 5.2 mm / 0.205 inch	
 10 ... 12 mm / 0.39 ... 0.47 inch	

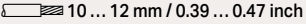
Technical Data	
0.25 ... 2.5 (4) mm ² ①	22 ... 12 AWG
690 V/6 kV/3 ②	600 V, 20 A ③
I _N 24 A (28 A) ④	600 V, 20 A ⑤
Terminal block width: 5.2 mm / 0.205 inch	
 10 ... 12 mm / 0.39 ... 0.47 inch	

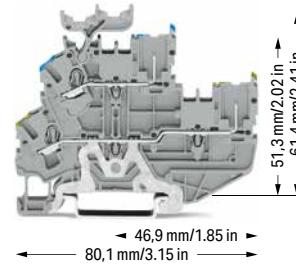
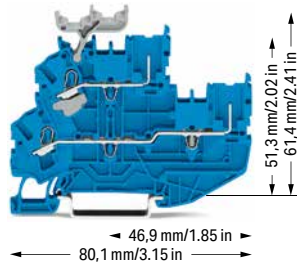
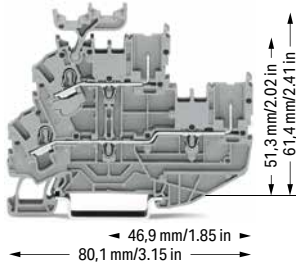

1-conductor/1-pin double-deck carrier terminal block; through/through terminal block; with marker carrier; gray

	Item No.	Pack. Unit
<input type="radio"/> L/L	2022-2231	50
<input type="radio"/> N/L	2022-2232	50
<input type="radio"/> L/N	2022-2233	50

1-conductor/1-pin double-deck carrier terminal block; through/through terminal block; with marker carrier; blue

	Item No.	Pack. Unit
<input checked="" type="radio"/> N/N	2022-2234	50

1-conductor/1-pin double-deck carrier terminal block; ground conductor/through terminal block; with marker carrier; gray

	Item No.	Pack. Unit
<input type="radio"/> PE/N	2022-2247	50
<input type="radio"/> PE/L	2022-2257	50

1-conductor/1-pin double-deck carrier terminal block; through/through terminal block; without marker carrier; gray

	Item No.	Pack. Unit
<input type="radio"/> L/L	2022-2201	50
<input type="radio"/> N/L	2022-2202	50
<input type="radio"/> L/N	2022-2203	50

1-conductor/1-pin double-deck carrier terminal block; through/through terminal block; without marker carrier; blue

	Item No.	Pack. Unit
<input checked="" type="radio"/> N/N	2022-2204	50

1-conductor/1-pin double-deck carrier terminal block; ground conductor/through terminal block; without marker carrier; gray

	Item No.	Pack. Unit
<input type="radio"/> PE/N	2022-2217	50
<input type="radio"/> PE/L	2022-2227	50

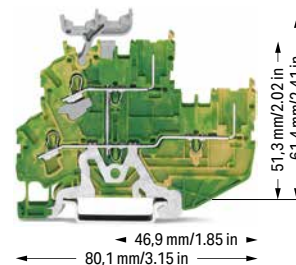
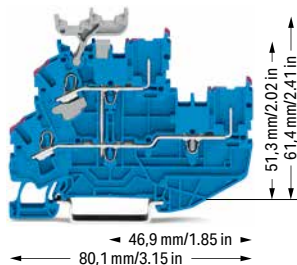
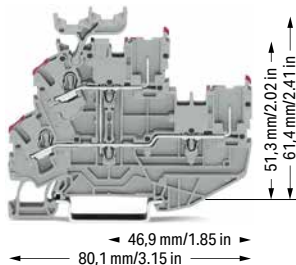

2-conductor/2-pin double-deck carrier terminal block; 2-conductor/2-pin through terminal block; with marker carrier, internally commoned; violet conductor entry; gray

	Item No.	Pack. Unit
<input type="radio"/> L	2022-2238	50

2-conductor/2-pin double-deck carrier terminal block; 2-conductor/2-pin through terminal block; with marker carrier, internally commoned; violet conductor entry; blue

	Item No.	Pack. Unit
<input checked="" type="radio"/> N	2022-2239	50

2-conductor/2-pin double-deck carrier block; 2-conductor/2-pin ground conductor block; with marker carrier, internally commoned; green-yellow

	Item No.	Pack. Unit
<input checked="" type="radio"/> PE	2022-2237	50

2-conductor/2-pin double-deck carrier terminal block; 2-conductor/2-pin through terminal block; without marker carrier, internally commoned; violet conductor entry; gray

	Item No.	Pack. Unit
<input type="radio"/> L	2022-2208	50

2-conductor/2-pin double-deck carrier terminal block; 2-conductor/2-pin through terminal block; without marker carrier, internally commoned; violet conductor entry; blue

	Item No.	Pack. Unit
<input checked="" type="radio"/> N	2022-2209	50

2-conductor/2-pin double-deck carrier block; 2-conductor/2-pin ground conductor block; without marker carrier, internally commoned; green-yellow

	Item No.	Pack. Unit
<input checked="" type="radio"/> PE	2022-2207	50

1 Conductor range: 0.25 ... 4 mm² "s+f-st";
Push-in termination: 1 ... 4 mm² "s" and 1 ... 2.5 mm² "insulated ferrules, 12 mm"
Depending on the conductor characteristic, a conductor with a smaller cross section can also be inserted via push-in termination.

2 690 V = rated voltage
6 kV = rated impulse voltage
3 = pollution degree

3 Current-carrying capacity curves upon request

Note:
When used as intended, female plugs must not be connected/disconnected when live or under load.

Please observe the application notes:
Jumpers, from page 174
Marking, from page 640

Approvals and corresponding ratings, visit www.wago.com

Accessories; 2022 Series

Appropriate marking systems:
WMB/WMB Inline/Marking strips

End and intermediate plate; 1 mm thick

	orange	2022-2292	100 (25)
	gray	2022-2291	100 (25)

Insulation stop; 5 pcs/strip; 0.25 ... 0.5 mm²

	light gray	2002-171	200 (25)
--	------------	----------	----------

Insulation stop; 5 pcs/strip; 0.75 ... 1 mm²

	dark gray	2002-172	200 (25)
---	-----------	----------	----------

Protective warning marker; with black high-voltage symbol; for 5 terminal blocks

	yellow	2002-115	100 (25)
---	--------	----------	----------

Push-in type jumper bar; insulated; I_N 25 A; light gray

	2-way	2002-402	25
	3-way	2002-403	25
	4-way	2002-404	25
	5-way	2002-405	25
	6-way	2002-406	25
	7-way	2002-407	25
	8-way	2002-408	25
	9-way	2002-409	25
	10-way	2002-410	25

Push-in type jumper bar; insulated; I_N 25 A; light gray

	1 to 3	2002-433	25
	1 to 4	2002-434	25
	1 to 5	2002-435	25
	1 to 6	2002-436	25
	1 to 7	2002-437	25
	1 to 8	2002-438	25
	1 to 9	2002-439	25
	1 to 10	2002-440	25

Adjacent jumper for continuous commoning; insulated; I_N 25 A, light gray

	2-way	2002-400	25
---	-------	----------	----

Adjacent jumper for continuous commoning; insulated; I_N 25 A; 1 to 3

	light gray	2002-423	25
	red	2002-423/000-005	25
	blue	2002-423/000-006	25

Accessories; 2022 Series

Appropriate marking systems:
WMB/WMB Inline/Marking strips

Double-deck vertical jumper; insulated; I_N 24 A

	light gray	2002-492	100 (25)
	orange	2002-492/000-012	100 (25)

Carrier with 6 coding pins; for coding female plugs

	orange	2022-100	100 (25)
---	--------	----------	----------

Test pin; 1 mm Ø

		859-500	1
---	--	---------	---

Test plug adapter; for 4 mm Ø test plug

	gray	2009-174	100 (25)
---	------	----------	----------

Testing tap; for max. 2.5 mm²

	gray	2009-182	100 (25)
---	------	----------	----------

1-conductor female plug

	gray	2022-101	200
---	------	----------	-----

Marking strip; plain; 11 mm wide; 50 m reel

	white	2009-110	1
---	-------	----------	---

WMB Inline, plain; 1,500 WMB markers (5 mm)/reel; 5 ... 5.2 mm stretchable

	white	2009-115	1
---	-------	----------	---

WMB marking card; white; 10 strips with 10 markers/card; 5 ... 5.2 mm stretchable

	plain	793-5501	5
---	-------	----------	---

Double-deck marker carrier; pivoting

	gray	2002-121	50 (25)
---	------	----------	---------



Size comparison:
Double-deck carrier terminal blocks with 3.5 mm and 5.2 mm terminal block widths

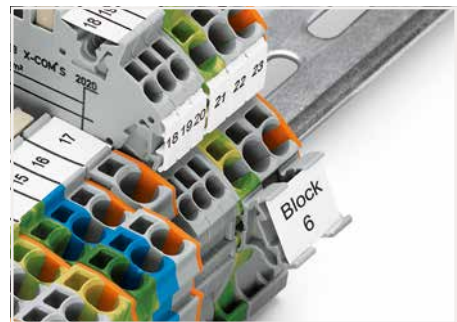

Marker carrier (2009-198)

1-Conductor Female Plug X-COM®S-SYSTEM

2.5 (4) mm²; 2022 Series

Technical Data

0.25 ... 2.5 (4) mm ² ①	22 ... 12 AWG
690 V/6 kV/3 ②	600 V, 20 A ③
I _N 24 A (32 A) ③	600 V, 20 A ③
Module width: 5.2 mm / 0.205 inch	
10 ... 12 mm / 0.39 ... 0.47 inch	



Dimensions (in mm):

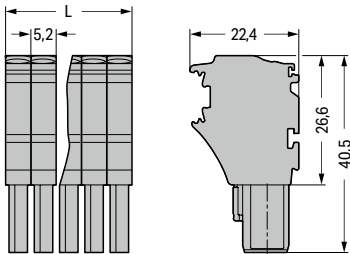

L = pole no. x module width

1-conductor female plug; fits into carrier terminal blocks; codable; gray
According to EN 61984, pluggable connectors without a current interrupting capacity must not be mated or unmated when live or under load.

Pole No.	Item No.	Pack. Unit
1	2022-101	200
2	2022-102	200
3	2022-103	100
4	2022-104	100
5	2022-105	50
6	2022-106	50
7	2022-107	50
8	2022-108	50
9	2022-109	50
10	2022-110	25
11	2022-111	25
12	2022-112	25
13	2022-113	25
14	2022-114	25
15	2022-115	25

Accessories; for female plugs

Appropriate marking systems:
WMB/WMB Inline/Marking strips

Insulation stop; 5 pcs/strip; 0.25 ... 0.5 mm²

light gray	2002-171	200 (25)
------------	----------	----------

Insulation stop; 5 pcs/strip; 0.75 ... 1 mm²

dark gray	2002-172	200 (25)
-----------	----------	----------

- Conductor range: 0.25 ... 4 mm² "s+f-st"; Push-in termination: 1 ... 4 mm² "s" and 1 ... 2.5 mm² "insulated ferrules, 12 mm"
Depending on the conductor characteristic, a conductor with a smaller cross section can also be inserted via push-in termination.
- 690 V = rated voltage
6 kV = rated impulse voltage
3 = pollution degree
- Current-carrying capacity curves upon request

Item no. suffixes

blue	.../000-006
orange	.../000-012
green-yellow	.../000-016

Approvals and corresponding ratings, visit www.wago.com

Accessories; for female plugs

Appropriate marking systems:
WMB/WMB Inline/Marking strips

Protective warning marker; with black high-voltage symbol; for 5 terminal blocks

yellow	2002-115	100 (25)
--------	----------	----------

Locking lever; 4.8 mm wide

orange	2022-142	100 (25)
gray	2022-141	100 (25)

Locking lever; 9.6 mm wide

orange	2022-152	100 (25)
gray	2022-151	100 (25)

Carrier with 6 coding pins; for coding female plugs

orange	2022-100	100 (25)
--------	----------	----------

Strain relief plate; gray

35 mm wide	734-326	100 (25)
6 mm wide	734-327	100 (25)
12.5 mm wide	734-328	100 (25)
25 mm wide	734-329	100 (25)
55 mm wide	734-430	50 (25)
75 mm wide	734-431	50 (25)

Marking strip; plain; 11 mm wide; 50 m reel

white	2009-110	1
-------	----------	---

WMB Inline, plain; 1,500 WMB markers (5 mm)/reel; 5 ... 5.2 mm stretchable

white	2009-115	1
-------	----------	---

WMB marking card; white; 10 strips with 10 markers/card; 5 ... 5.2 mm stretchable

plain	793-5501	5
-------	----------	---



Coding a female plug: remove coding finger using a suitable tool.

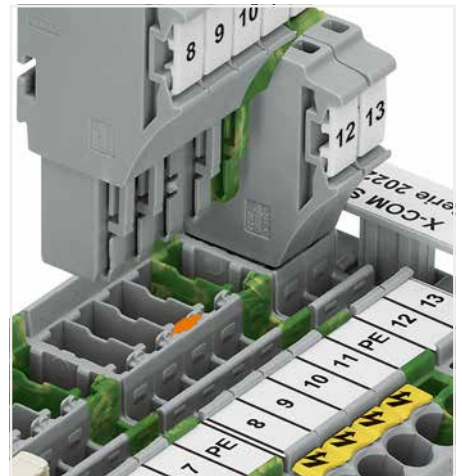

Insert a coding pin (2022-100) into the corresponding location of the carrier terminal block.

Carrier Terminal Blocks and 1-Conductor Female Plugs X-COM®S-SYSTEM

Types of Assembly

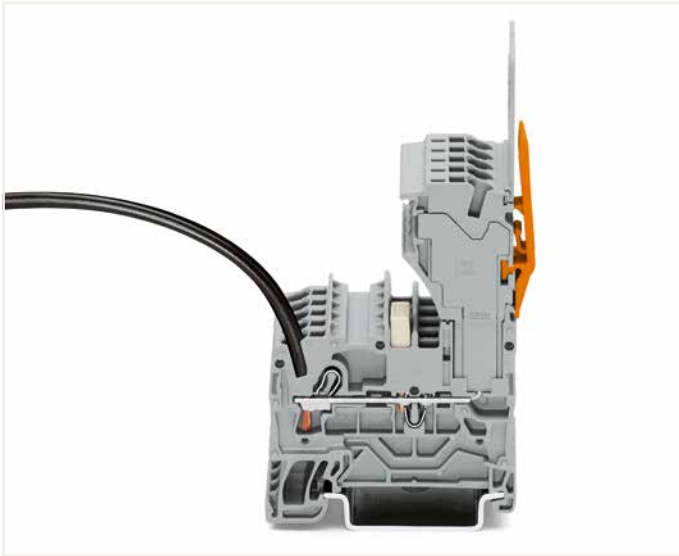

1-conductor female plug
Carrier terminal blocks can be commoned via 2002 Series Push-In Type Jumper Bars and tested via 859-500 Test Pin.

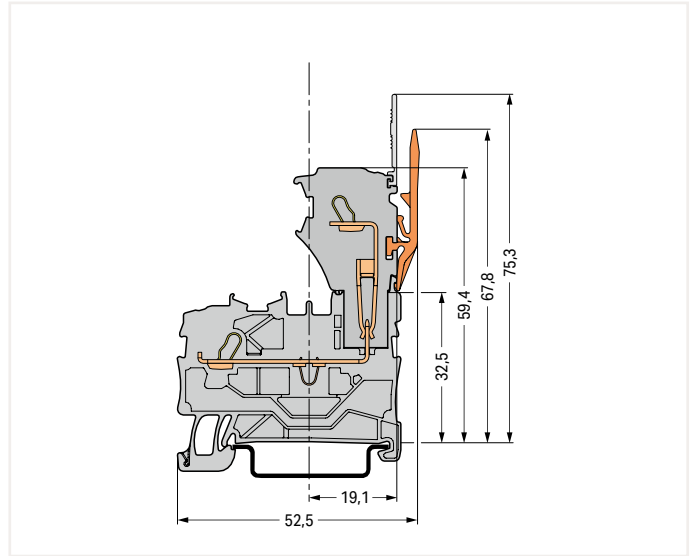

Carrier terminal block

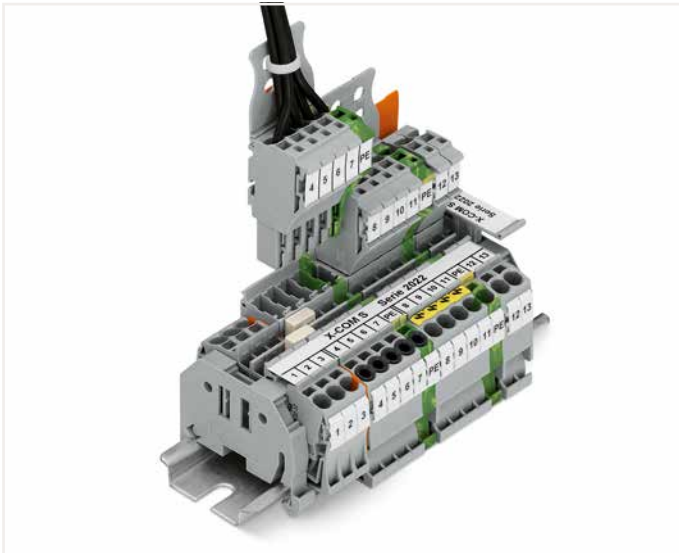

X-COM®S-SYSTEM terminal block assembly

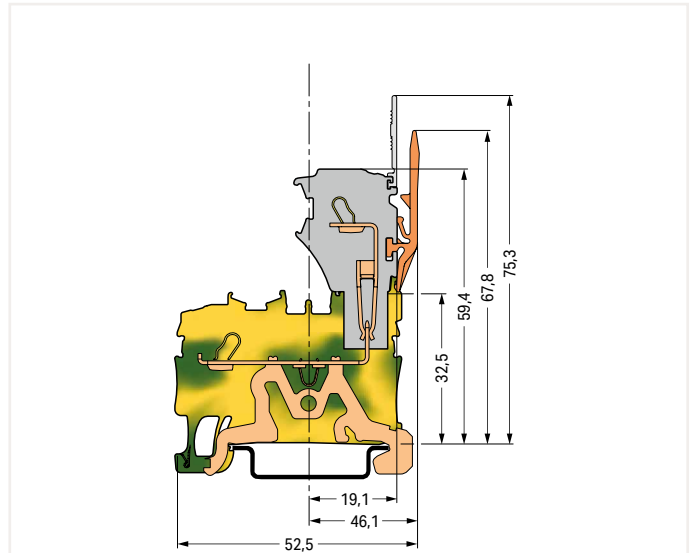

Ground carrier terminal block

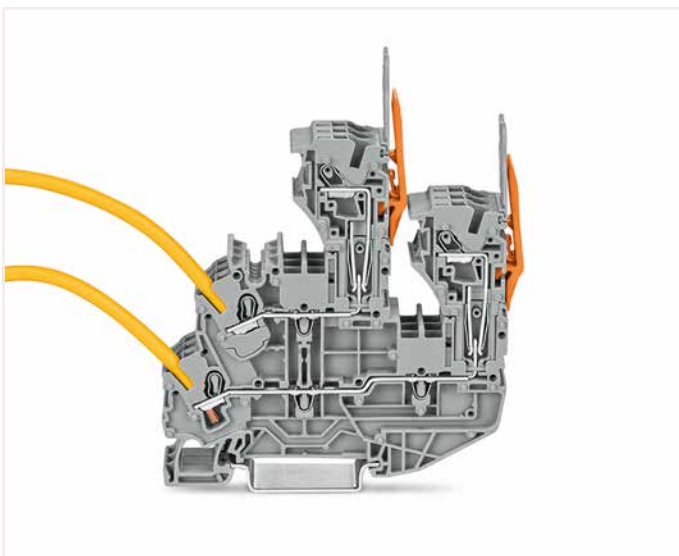

1-conductor female plug
Double-deck carrier terminal blocks can be commoned via 2002 Series Push-In Type Jumper Bars and tested via 859-500 Test Pin.

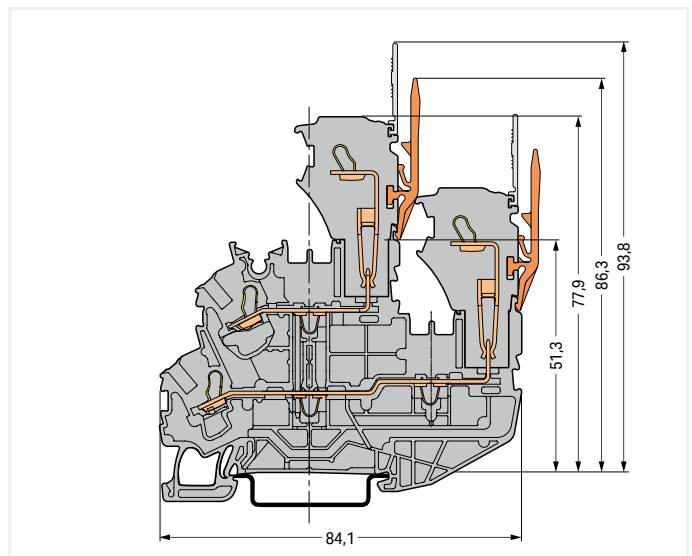

Double-deck carrier terminal block

Female Plug for Self-Assembly X-COM®S-SYSTEM

2.5 (4) mm²; 2022 Series

Technical Data

0.25 ... 2.5 (4) mm² ① 22 ... 12 AWG

690 V/6 kV/3 ② 600 V, 20 A^{III}





I_N 24 A (32 A) ③ 600 V, 20 A^{II}

Terminal block width: 5.2 mm / 0.205 inch

 10 ... 12 mm / 0.39 ... 0.47 inch



1-conductor end module; codable

Color	Item No.	Pack. Unit
 gray	2022-181	250
 blue	2022-184	250
 orange	2022-182	250
 green-yellow	2022-187	250

1-conductor center module; codable

 gray	2022-171	250
 blue	2022-174	250
 orange	2022-172	250
 green-yellow	2022-177	250

1-conductor base module; with integrated end plate; codable

 gray	2022-161	250
 blue	2022-164	250
 orange	2022-162	250
 green-yellow	2022-167	250

Accessories; for female plugs

Appropriate marking systems:
WMB/WMB Inline/Marking strips

Insulation stop; 5 pcs/strip; 0.25 ... 0.5 mm²

 light gray	2002-171	200 (25)
---	----------	----------

Insulation stop; 5 pcs/strip; 0.75 ... 1 mm²

 dark gray	2002-172	200 (25)
--	----------	----------

Protective warning marker; with black high-voltage symbol; for 5 terminal blocks

 yellow	2002-115	100 (25)
---	----------	----------

Locking lever; 4.8 mm wide

 orange	2022-142	100 (25)
gray	2022-141	100 (25)

Locking lever; 9.6 mm wide

 orange	2022-152	100 (25)
gray	2022-151	100 (25)

Carrier with 6 coding pins; for coding female plugs

 orange	2022-100	100 (25)
---	----------	----------

① Conductor range: 0.25 ... 4 mm² "s+f-st";
Push-in termination: 1 ... 4 mm² "s" and 1 ... 2.5 mm² "insulated ferrules, 12 mm"
Depending on the conductor characteristic, a conductor with a smaller cross section can also be inserted via push-in termination.

② 690 V = rated voltage
6 kV = rated impulse voltage
3 = pollution degree

③ Current-carrying capacity curves upon request

Note:

According to EN 61984, pluggable connectors without a current interrupting capacity must not be mated or unmated when live or under load.

Approvals and corresponding ratings,
visit www.wago.com

Accessories; for female plugs

Appropriate marking systems:
WMB/WMB Inline/Marking strips

Strain relief plate; gray

 35 mm wide	734-326	100 (25)
6 mm wide	734-327	100 (25)
12.5 mm wide	734-328	100 (25)
25 mm wide	734-329	100 (25)
55 mm wide	734-430	50 (25)
75 mm wide	734-431	50 (25)

Marking strip; plain; 11 mm wide; 50 m reel

 white	2009-110	1
---	----------	---

WMB Inline, plain; 1,500 WMB markers (5 mm)/reel; 5 ... 5.2 mm stretchable

 white	2009-115	1
---	----------	---

WMB marking card; white; 10 strips with 10 markers/card; 5 ... 5.2 mm stretchable

 plain	793-5501	5
---	----------	---

Customizing Modular Female Plugs

WAGO's modular X-COM®S-SYSTEM female plugs can be customized for applications requiring varying numbers of poles (e.g., when designing prototypes).

Modules and Pole Numbers

A customized X-COM®S-SYSTEM female plug consists of:

- One base module with an integrated end plate
- Up to 13 center modules (corresponding to a 15-pole female plug = maximum pole number)
- One end module

Intended Use

According to EN 61984, pluggable connectors without a current interrupting capacity must not be mated or unmated when live or under load.

Mounting

The appropriate mounting tool shall be used in order to guarantee that the individual modules are properly attached to each other without damaging the locking latches.

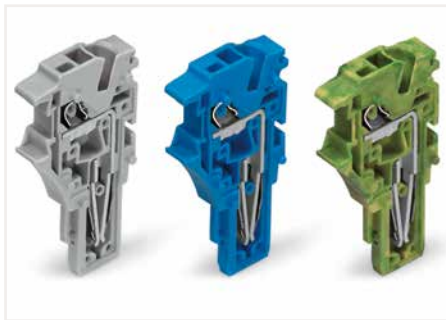

End module

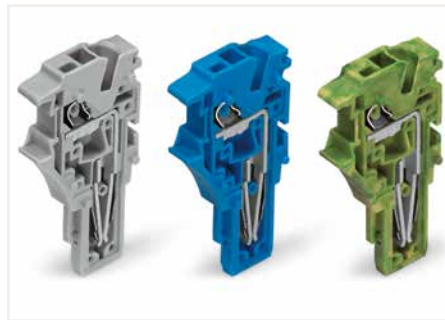

Center module



Base module

Example: 5-Pole, 1-Conductor Female Plug

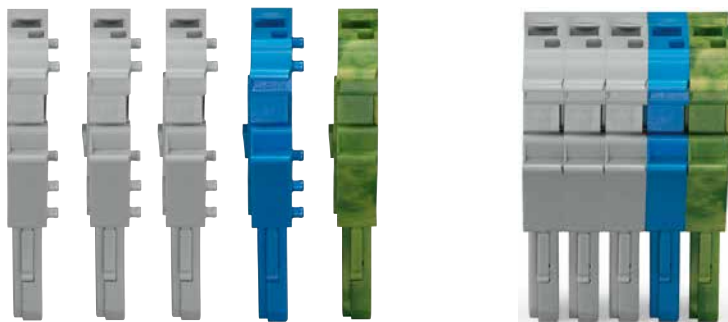

Base module with integrated end plate
2022-167

Center module
2022-174

Center modules
2022-171

End module
2022-181

Pre-Assembled 1-Conductor Female Plug X-COM®S-SYSTEM 2.5 (4) mm²; 2022 Series

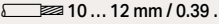
Technical Data	
0.25 ... 2.5 (4) mm ² ①	22 ... 12 AWG
690 V/6 kV/3 ②	600 V, 20 A ③
I _N 24 A (32 A) ④	600 V, 20 A ⑤
Module width: 5.2 mm / 0.205 inch	
 10 ... 12 mm / 0.39 ... 0.47 inch	

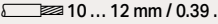
Technical Data	
0.25 ... 2.5 (4) mm ² ①	22 ... 12 AWG
690 V/6 kV/3 ②	600 V, 20 A ③
I _N 24 A (32 A) ④	600 V, 20 A ⑤
Module width: 5.2 mm / 0.205 inch	
 10 ... 12 mm / 0.39 ... 0.47 inch	

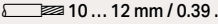
Technical Data	
0.25 ... 2.5 (4) mm ² ①	22 ... 12 AWG
690 V/6 kV/3 ②	600 V, 20 A ③
I _N 24 A (32 A) ④	600 V, 20 A ⑤
Module width: 5.2 mm / 0.205 inch	
 10 ... 12 mm / 0.39 ... 0.47 inch	



1-conductor female plug; with ground base module (green-yellow); fits into carrier terminal blocks; codable

Pole No.	Item No.	Pack. Unit
3	2022-103/000-036	100
4	2022-104/000-036	100
5	2022-105/000-036	50
6	2022-106/000-036	50
7	2022-107/000-036	50
8	2022-108/000-036	50
9	2022-109/000-036	50
10	2022-110/000-036	25
11	2022-111/000-036	25
12	2022-112/000-036	25
13	2022-113/000-036	25
14	2022-114/000-036	25
15	2022-115/000-036	25

1-conductor female plug; with ground end module (green-yellow); fits into carrier terminal blocks; codable

Pole No.	Item No.	Pack. Unit
3	2022-103/000-037	100
4	2022-104/000-037	100
5	2022-105/000-037	50
6	2022-106/000-037	50
7	2022-107/000-037	50
8	2022-108/000-037	50
9	2022-109/000-037	50
10	2022-110/000-037	25
11	2022-111/000-037	25
12	2022-112/000-037	25
13	2022-113/000-037	25
14	2022-114/000-037	25
15	2022-115/000-037	25

1-conductor female plug; with ground base module (green-yellow); fits into carrier terminal blocks; codable

Pole No.	Item No.	Pack. Unit
3	2022-103/000-038	100
4	2022-104/000-038	100
5	2022-105/000-038	50
6	2022-106/000-038	50
7	2022-107/000-038	50
8	2022-108/000-038	50
9	2022-109/000-038	50
10	2022-110/000-038	25
11	2022-111/000-038	25
12	2022-112/000-038	25
13	2022-113/000-038	25
14	2022-114/000-038	25
15	2022-115/000-038	25

Accessories; for female plugs

Appropriate marking systems: WMB/WMB Inline/Marking strips

Insulation stop; 5 pcs/strip; 0.25 ... 0.5 mm²

light gray	2002-171	200 (25)
------------	----------	----------

Insulation stop; 5 pcs/strip; 0.75 ... 1 mm²

dark gray	2002-172	200 (25)
-----------	----------	----------

Protective warning marker; with black high-voltage symbol; for 5 terminal blocks

yellow	2002-115	100 (25)
--------	----------	----------

Locking lever; 4.8 mm wide

orange	2022-142	100 (25)
gray	2022-141	100 (25)

Locking lever; 9.6 mm wide

orange	2022-152	100 (25)
gray	2022-151	100 (25)

Carrier with 6 coding pins; for coding female plugs

orange	2022-100	100 (25)
--------	----------	----------

Strain relief plate; gray

35 mm wide	734-326	100 (25)
6 mm wide	734-327	100 (25)
12.5 mm wide	734-328	100 (25)
25 mm wide	734-329	100 (25)
55 mm wide	734-430	50 (25)
75 mm wide	734-431	50 (25)

Marking strip; plain; 11 mm wide; 50 m reel

white	2009-110	1
-------	----------	---

WMB Inline, plain; 1,500 WMB markers (5 mm)/reel; 5 ... 5.2 mm stretchable

white	2009-115	1
-------	----------	---

WMB marking card; white; 10 strips with 10 markers/card; 5 ... 5.2 mm stretchable

plain	793-5501	5
-------	----------	---

Technical Data

0.25 ... 2.5 (4) mm ² ①	22 ... 12 AWG
690 V/6 kV/3 ②	600 V, 20 A ③
I _N 24 A (32 A) ③	600 V, 20 A ③
Module width: 5.2 mm / 0.205 inch	
10 ... 12 mm / 0.39 ... 0.47 inch	

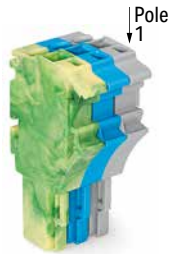

① Conductor range: 0.25 ... 4 mm² "s+f-st";
Push-in termination: 1 ... 4 mm² "s" and 1 ... 2.5 mm² "insulated ferrules, 12 mm"
Depending on the conductor characteristic, a conductor with a smaller cross section can also be inserted via push-in termination.

② 690 V = rated voltage
6 kV = rated impulse voltage
3 = pollution degree

③ Current-carrying capacity curves upon request

Note:

According to EN 61984, pluggable connectors without a current interrupting capacity must not be mated or unmated when live or under load.

Approvals and corresponding ratings, visit www.wago.com

1-conductor female plug; with ground end module (green-yellow); fits into carrier terminal blocks; codable

Pole No.	Item No.	Pack. Unit
3	2022-103/000-039	100
4	2022-104/000-039	100
5	2022-105/000-039	50
6	2022-106/000-039	50
7	2022-107/000-039	50
8	2022-108/000-039	50
9	2022-109/000-039	50
10	2022-110/000-039	25
11	2022-111/000-039	25
12	2022-112/000-039	25
13	2022-113/000-039	25
14	2022-114/000-039	25
15	2022-115/000-039	25

1-Conductor Female Plug X-COM®S-SYSTEM; with Lateral Locking Lever and Strain Relief Plate 2.5 (4) mm²; 2022 Series

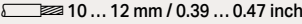
Technical Data	
0.25 ... 2.5 (4) mm ² ①	22 ... 12 AWG
690 V/6 kV/3 ②	600 V, 20 A ③
I _N 24 A (32 A) ④	600 V, 20 A ⑤
Module width: 5.2 mm / 0.205 inch	
	

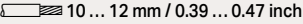
Technical Data	
0.25 ... 2.5 (4) mm ² ①	22 ... 12 AWG
690 V/6 kV/3 ②	600 V, 20 A ③
I _N 24 A (32 A) ④	600 V, 20 A ⑤
Module width: 5.2 mm / 0.205 inch	
	

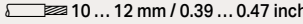
Technical Data	
0.25 ... 2.5 (4) mm ² ①	22 ... 12 AWG
690 V/6 kV/3 ②	600 V, 20 A ③
I _N 24 A (32 A) ④	600 V, 20 A ⑤
Module width: 5.2 mm / 0.205 inch	
	



1-conductor female plug; with locking lever; fits into carrier terminal blocks; codable; gray

Pole No.	Item No.	Pack. Unit
○ 1	2022-101/122-000	200
○ 2	2022-102/122-000	100
○ 3	2022-103/123-000	100
○ 4	2022-104/123-000	50
○ 5	2022-105/123-000	50
○ 6	2022-106/123-000	50
○ 7	2022-107/123-000	25
○ 8	2022-108/123-000	25
○ 9	2022-109/123-000	25
○ 10	2022-110/123-000	25
○ 11	2022-111/126-000	25
○ 12	2022-112/126-000	20
○ 13	2022-113/126-000	20
○ 14	2022-114/126-000	10
○ 15	2022-115/127-000	10

1-conductor female plug; with strain relief plate; fits into carrier terminal blocks; codable; gray

Pole No.	Item No.	Pack. Unit
○ 1	2022-101/132-000	200
○ 2	2022-102/132-000	100
○ 3	2022-103/133-000	100
○ 4	2022-104/133-000	50
○ 5	2022-105/134-000	50
○ 6	2022-106/134-000	50
○ 7	2022-107/135-000	25
○ 8	2022-108/135-000	25
○ 9	2022-109/135-000	25
○ 10	2022-110/135-000	25
○ 11	2022-111/136-000	25
○ 12	2022-112/136-000	20
○ 13	2022-113/136-000	20
○ 14	2022-114/136-000	10
○ 15	2022-115/137-000	10

1-conductor female plug; with strain relief plate and locking lever; fits into carrier terminal blocks; codable; gray

Pole No.	Item No.	Pack. Unit
○ 1	2022-101/142-000	200
○ 2	2022-102/142-000	100
○ 3	2022-103/143-000	100
○ 4	2022-104/143-000	50
○ 5	2022-105/144-000	50
○ 6	2022-106/144-000	50
○ 7	2022-107/145-000	25
○ 8	2022-108/145-000	25
○ 9	2022-109/145-000	25
○ 10	2022-110/145-000	25
○ 11	2022-111/146-000	25
○ 12	2022-112/146-000	20
○ 13	2022-113/146-000	20
○ 14	2022-114/146-000	10
○ 15	2022-115/147-000	10

1-conductor female plug; with locking lever; fits into carrier terminal blocks; codable

● 1 blue	2022-101/122-006	200
● 1 green-yellow	2022-101/122-016	200

1-conductor female plug; with strain relief plate; fits into carrier terminal blocks; codable

● 1 blue	2022-101/132-006	200
● 1 green-yellow	2022-101/132-016	200

1-conductor female plug; with strain relief plate and locking lever; fits into carrier terminal blocks; codable

● 1 blue	2022-101/142-006	200
● 1 green-yellow	2022-101/142-016	200

Accessories; for female plugs

Appropriate marking systems: WMB/WMB Inline/Marking strips

Insulation stop; 5 pcs/strip; 0.25 ... 0.5 mm²

	light gray	2002-171	200 (25)
---	------------	----------	----------

Marking strip; plain; 11 mm wide; 50 m reel

	white	2009-110	1
---	-------	----------	---

Insulation stop; 5 pcs/strip; 0.75 ... 1 mm²

	dark gray	2002-172	200 (25)
---	-----------	----------	----------

WMB Inline, plain; 1,500 WMB markers (5 mm)/reel; 5 ... 5.2 mm stretchable

	white	2009-115	1
---	-------	----------	---

Protective warning marker; with black high-voltage symbol; for 5 terminal blocks

	yellow	2002-115	100 (25)
---	--------	----------	----------

WMB marking card; white; 10 strips with 10 markers/card; 5 ... 5.2 mm stretchable

	plain	793-5501	5
---	-------	----------	---

Carrier with 6 coding pins; for coding female plugs

	orange	2022-100	100 (25)
---	--------	----------	----------

① Conductor range: 0.25 ... 4 mm² "s+f-st";
 Push-in termination: 1 ... 4 mm² "s" and 1 ... 2.5 mm² "insulated ferrules, 12 mm"
 Depending on the conductor characteristic, a conductor with a smaller cross section can also be inserted via push-in termination.

② 690 V = rated voltage
 6 kV = rated impulse voltage
 3 = pollution degree

③ Current-carrying capacity curves upon request

Note:
 According to EN 61984, pluggable connectors without a current interrupting capacity must not be mated or unmated when live or under load.

Approvals and corresponding ratings, visit www.wago.com

Strain Relief Plate (SRP), Gray				Locking Lever (LL), Gray				SRP and LL, Gray
Assembled				Assembled				Assembled
SRP				Pole No.	Quantity	1-Way	2-Way	
Item No. Suffix				Item No. Suffix				Item No. Suffix
Item No.	Color	Width						
734-327	gray	6mm	/132-0xx	1 to 2	1	/122-0xx	-	/142-0xx
734-328	gray	12.5mm	/133-0xx	3 to 4	1	-	/123-0xx	/143-0xx
734-329	gray	25mm	/134-0xx	5 to 6	1	-	/123-0xx	/144-0xx
734-326	gray	35mm	/135-0xx	7 to 10	1	-	/123-0xx	/145-0xx
734-430	gray	55mm	/136-0xx	11 to 14	2	-	/126-0xx	/146-0xx
734-431	gray	75mm	/137-0xx	15	2	-	/127-0xx	/147-0xx

For colored female plugs, the item number suffix "xx" must be replaced by the blue "-006" and the green-yellow "-016" color suffix.

Dimensions of locking levers

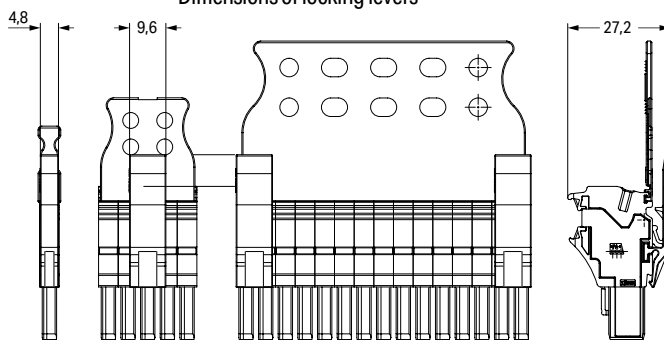

Description	Color	Item No.	Suffix No.
1-conductor female plug	gray	2022-101	none
1- to 15-pole	blue green-yellow	to 2022-115	/000-006 /000-016

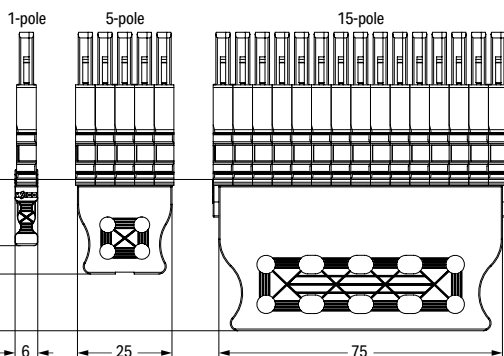
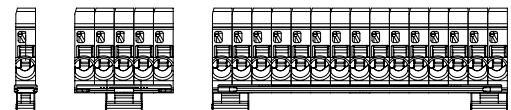

Dimensions of strain relief plates

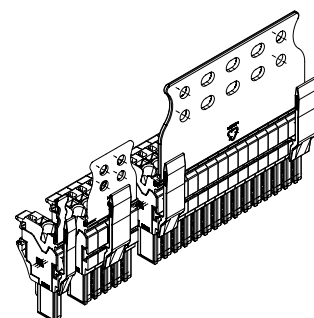

1-Conductor/1-Pin Carrier Terminal Block, 2-Conductor/1-Pin Carrier Terminal Block, 2-Conductor/2-Pin Carrier Terminal Block X-COM®S-SYSTEM; for Ex ec Applications 2.5 (4) mm²; 2022 Series

2

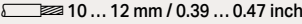
Technical Data	
0.25 ... 2.5 (4) mm ² ①	22 ... 12 AWG
630 V ②	600 V, 20 A ③
I _N 20 A	600 V, 20 A ④
Terminal block width: 5.2 mm / 0.205 inch	
 10 ... 12 mm / 0.39 ... 0.47 inch	

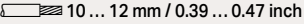
Technical Data	
0.25 ... 2.5 (4) mm ² ①	22 ... 12 AWG
630 V ②	600 V, 20 A ③
I _N 20 A	600 V, 20 A ④
Terminal block width: 5.2 mm / 0.205 inch	
 10 ... 12 mm / 0.39 ... 0.47 inch	

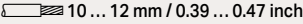
Technical Data	
0.25 ... 2.5 (4) mm ² ①	22 ... 12 AWG
630 V ②	600 V, 20 A ③
I _N 20 A	600 V, 20 A ④
Terminal block width: 5.2 mm / 0.205 inch	
 10 ... 12 mm / 0.39 ... 0.47 inch	

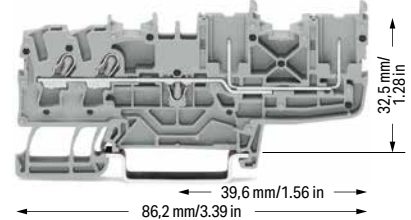
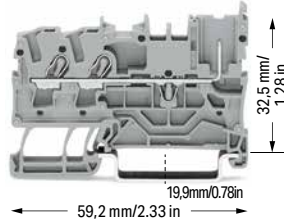
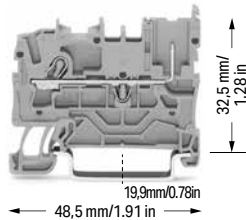

1-conductor/1-pin carrier terminal block; suitable for Ex ec applications		
Color	Item No.	Pack. Unit
gray ⑤	2022-1201/999-953	100
blue ⑤	2022-1204/999-953	100



2-conductor/1-pin carrier terminal block; suitable for Ex ec applications		
Color	Item No.	Pack. Unit
gray ⑤	2022-1301/999-953	100
blue ⑤	2022-1304/999-953	100



2-conductor/2-pin carrier terminal block; suitable for Ex ec applications		
Color	Item No.	Pack. Unit
gray ⑤	2022-1401/999-953	50
blue ⑤	2022-1404/999-953	50



1-conductor/1-pin ground carrier terminal block; suitable for Ex ec applications		
Color	Item No.	Pack. Unit
green-yellow ⑤	2022-1207/999-953	100

2-conductor/1-pin ground carrier terminal block; suitable for Ex ec applications		
Color	Item No.	Pack. Unit
green-yellow ⑤	2022-1307/999-953	100

2-conductor/2-pin ground carrier terminal block; suitable for Ex ec applications		
Color	Item No.	Pack. Unit
green-yellow ⑤	2022-1407/999-953	50

Accessories; item-specific			
End and intermediate plate; 1 mm thick			
	orange	2022-1292	100 (25)
	gray	2022-1291	100 (25)

Accessories; item-specific			
End and intermediate plate; 1 mm thick			
	orange	2022-1392	100 (25)
	gray	2022-1391	100 (25)

Accessories; item-specific			
End and intermediate plate; 1 mm thick			
	orange	2022-1492	100 (25)
	gray	2022-1491	100 (25)

Accessories; 2022 Series

Appropriate marking systems: WMB/WMB Inline/Marking strips

Insulation stop; 5 pcs/strip; 0.25 ... 0.5 mm ²			
	light gray	2002-171	200 (25)

Insulation stop; 5 pcs/strip; 0.75 ... 1 mm ²			
	dark gray	2002-172	200 (25)

Protective warning marker; with black high-voltage symbol; for 5 terminal blocks			
	yellow	2002-115	100 (25)

Push-in type jumper bar; insulated; I _N 25 A; light gray			
	2-way	2002-402	25
	3-way	2002-403	25
	4-way	2002-404	25
	5-way	2002-405	25
	6-way	2002-406	25
	7-way	2002-407	25
	8-way	2002-408	25
	9-way	2002-409	25
	10-way	2002-410	25

Push-in type jumper bar; insulated; I _N 25 A; light gray			
	1 to 3	2002-433	25
	1 to 4	2002-434	25
	1 to 5	2002-435	25
	1 to 6	2002-436	25
	1 to 7	2002-437	25
	1 to 8	2002-438	25
	1 to 9	2002-439	25
	1 to 10	2002-440	25

Staggered jumper; insulated; I _N 25 A; light gray			
	2-way	2002-472	25
	3-way	2002-473	25
	4-way	2002-474	25
	5-way	2002-475	25
	6-way	2002-476	25
	7-way	2002-477	25
	8-way	2002-478	25
	9-way	2002-479	25
	10-way	2002-480	25
	11-way	2002-481	25
	12-way	2002-482	25

Push-in type wire jumper; insulated; 1.5 mm ² conductor cross-section; I _N 18 A			
	L = 60 mm	2009-412	100 (10)
	L = 110 mm	2009-414	100 (10)
	L = 250 mm	2009-416	100 (10)

Carrier with 6 coding pins; for coding female plugs			
	orange	2022-100	100 (25)

Test pin; 1 mm Ø			
		859-500	1

1-conductor female plug; with shorter locking lever; suitable for Ex ec applications; fits into carrier terminal blocks; codable			
	gray	2022-103/999-953	100

Marking strip; plain; 11 mm wide; 50 m reel			
	white	2009-110	1

WMB Inline, plain; 1,500 WMB markers (5 mm)/reel; 5 ... 5.2 mm stretchable			
	white	2009-115	1

WMB marking card; white; 10 strips with 10 markers/card; 5 ... 5.2 mm stretchable			
	plain	793-5501	5

1 Conductor range: 0.25 ... 4 mm² "s+f-st";
 Push-in termination: 1 ... 4 mm² "s" and 1 ... 2.5 mm²
 "insulated ferrules, 12 mm"
 Depending on the conductor characteristic, a conductor
 with a smaller cross section can also be inserted
 via push-in termination.

2 630 V = rated voltage for use in Zone 2 hazardous
 areas, "nA" type of protection

Note:
 When used as intended, female plugs must not be
 connected/disconnected when live or under load.

Please observe the application notes:
 Jumpers, from page 174
 Marking, from page 640

Approvals and corresponding ratings,
 visit www.wago.com



630 V = rated voltage for use in Zone 2 hazardous areas,
 "nA" type of protection

Ex marking:
 "Ex" sign and extended item number ".../999-953" are
 printed on the side of both carrier terminal blocks and
 female plugs with Ex approval.
 Shorter locking lever (factory-mounted) makes accidental
 disconnection more difficult.

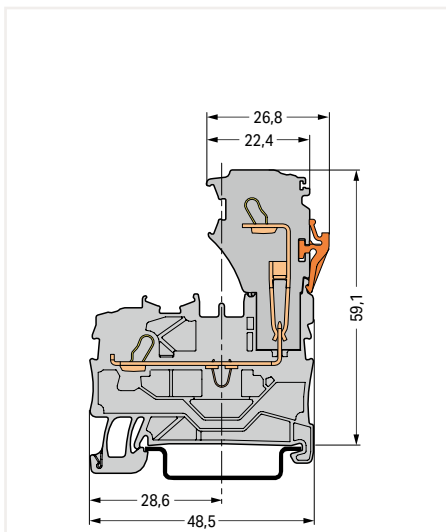

Carrier terminal block

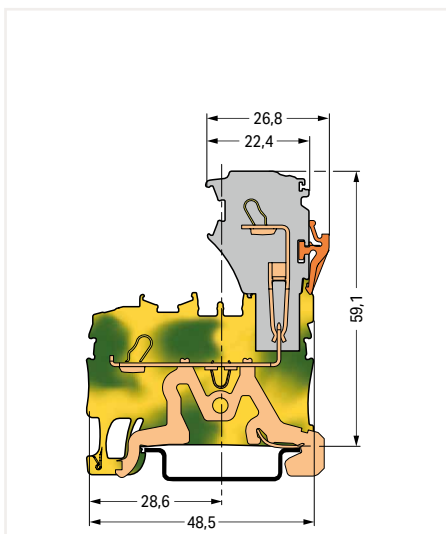

Ground carrier terminal block

2-Pin Carrier Terminal Block and 4-Pin Carrier Terminal Block X-COM®S-SYSTEM; for Ex ec Applications 2022 Series

Technical Data	
630 V ①	600 V, 20 A ②
I _N 20 A ②	600 V, 20 A ③
Terminal block width: 5.2 mm / 0.205 inch	

Technical Data	
630 V ①	600 V, 20 A ②
I _N 20 A ②	600 V, 20 A ③
Terminal block width: 5.2 mm / 0.205 inch	

① 630 V = rated voltage for use in Zone 2 hazardous areas, "nA" type of protection

Note:
When used as intended, female plugs must not be connected/disconnected when live or under load.

See application notes in our Full Line Catalog, Volume 1. Jumpers, from page 152
Marking, from page 640

Approvals and corresponding ratings, visit www.wago.com

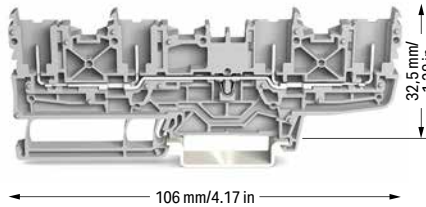
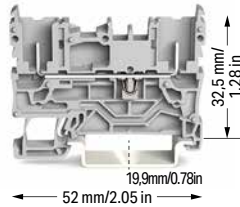

2-pin carrier terminal block; for Ex ec applications		
Color	Item No.	Pack. Unit
gray ④	2022-1601/999-953	50
blue ④	2022-1604/999-953	50

4-pin carrier terminal block; for Ex ec applications		
Color	Item No.	Pack. Unit
gray ④	2022-1801/999-953	50
blue ④	2022-1804/999-953	50

2-pin ground carrier terminal block; for Ex ec applications		
green-yellow ④	2022-1607/999-953	50

4-pin ground carrier terminal block; for Ex ec applications		
green-yellow ④	2022-1807/999-953	50

Accessories; item-specific			
End plate; 1 mm thick			
	orange	2022-1692	100 (25)
	gray	2022-1691	100 (25)

Accessories; item-specific			
End plate; 1 mm thick			
	orange	2022-1892	100 (25)
	gray	2022-1891	100 (25)

Accessories; 2022 Series
Appropriate marking systems: WMB/WMB Inline/Marking strips

Push-in type jumper bar; insulated; I _N 25 A; light gray		
	2-way	2002-402 25
	3-way	2002-403 25
	4-way	2002-404 25
	5-way	2002-405 25
	6-way	2002-406 25
	7-way	2002-407 25
	8-way	2002-408 25
	9-way	2002-409 25
	10-way	2002-410 25

Push-in type wire jumper; insulated; 1.5 mm ² conductor cross-section; I _N 18 A			
	L = 60 mm	2009-412	100 (10)
	L = 110 mm	2009-414	100 (10)
	L = 250 mm	2009-416	100 (10)

Push-in type jumper bar; insulated; I _N 25 A; light gray		
	1 to 3	2002-433 25
	1 to 4	2002-434 25
	1 to 5	2002-435 25
	1 to 6	2002-436 25
	1 to 7	2002-437 25
	1 to 8	2002-438 25
	1 to 9	2002-439 25
	1 to 10	2002-440 25

Carrier with 6 coding pins; for coding female plugs		
	orange	2022-100 100 (25)

1-conductor female plug; with shorter locking lever; suitable for Ex ec applications; fits into carrier terminal blocks; codable			
	gray	2022-103/999-953	100

Staggered jumper; insulated; I _N 25 A; light gray		
	2-way	2002-472 25
	3-way	2002-473 25
	4-way	2002-474 25
	5-way	2002-475 25
	6-way	2002-476 25
	7-way	2002-477 25
	8-way	2002-478 25
	9-way	2002-479 25
	10-way	2002-480 25
	11-way	2002-481 25
	12-way	2002-482 25

Marking strip; plain; 11 mm wide; 50 m reel		
	white	2009-110 1

WMB Inline; plain; 1,500 WMB markers (5 mm)/reel; stretchable 5 ... 5.2 mm		
	white	2009-115 1

WMB marker card; white; 10 strips with 10 markers/card; stretchable 5 ... 5.2 mm		
	plain	793-5501 5

1-Conductor/1-Pin Double-Deck Carrier Terminal Block X-COM®S-SYSTEM; for Ex ec Applications 2.5 (4) mm²; 2022 Series

Technical Data	
0.25 ... 2.5 (4) mm ² ①	22 ... 12 AWG
630 V ②	600 V; 20 A ③
I _N 20 A	600 V; 20 A ④
Terminal block width: 5.2 mm / 0.205 inch	
 10 ... 12 mm / 0.39 ... 0.47 inch	

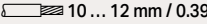
Technical Data	
0.25 ... 2.5 (4) mm ² ①	22 ... 12 AWG
630 V ②	600 V; 20 A ③
I _N 20 A	600 V; 20 A ④
Terminal block width: 5.2 mm / 0.205 inch	
 10 ... 12 mm / 0.39 ... 0.47 inch	

Technical Data	
0.25 ... 2.5 (4) mm ² ①	22 ... 12 AWG
630 V ②	600 V; 20 A ③
I _N 20 A	600 V; 20 A ④
Terminal block width: 5.2 mm / 0.205 inch	
 10 ... 12 mm / 0.39 ... 0.47 inch	

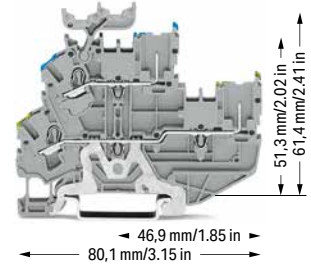
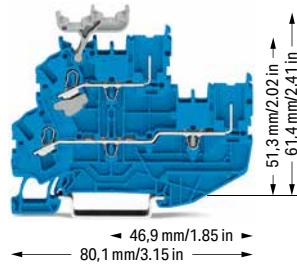
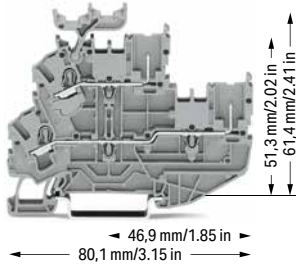

1-conductor/1-pin double-deck carrier terminal block; through/through terminal block; with marker carrier; suitable for Ex ec applications; gray

	Item No.	Pack. Unit
○ L/L ⑤	2022-2231/999-953	50
○ N/L ⑤	2022-2232/999-953	50
○ L/N ⑤	2022-2233/999-953	50

1-conductor/1-pin double-deck carrier terminal block; through/through terminal block; with marker carrier; suitable for Ex ec applications; blue

	Item No.	Pack. Unit
● N/N ⑤	2022-2234/999-953	50

1-conductor/1-pin double-deck carrier terminal block; ground conductor/through terminal block; with marker carrier; for Ex ec applications; gray

	Item No.	Pack. Unit
○ PE/N ⑤	2022-2247/999-953	50
○ PE/L ⑤	2022-2257/999-953	50

1-conductor/1-pin double-deck carrier terminal block; through/through terminal block; without marker carrier; for Ex ec applications; gray

○ L/L ⑤	2022-2201/999-953	50
○ N/L ⑤	2022-2202/999-953	50
○ L/N ⑤	2022-2203/999-953	50

1-conductor/1-pin double-deck carrier terminal block; through/through terminal block; without marker carrier; for Ex ec applications; blue

● N/N ⑤	2022-2204/999-953	50
---------	-------------------	----

1-conductor/1-pin double-deck carrier terminal block; ground conductor/through terminal block; without marker carrier; for Ex ec applications; gray

○ PE/N ⑤	2022-2217/999-953	50
○ PE/L ⑤	2022-2227/999-953	50

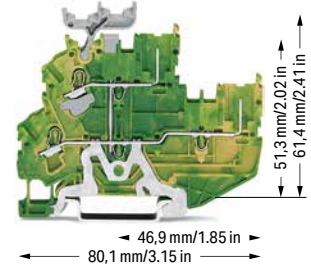
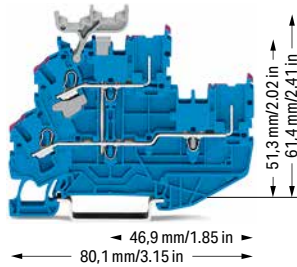
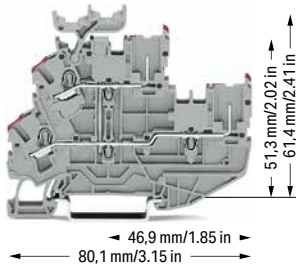

2-conductor/2-pin double-deck carrier terminal block; 2-conductor/2-pin through terminal block; with marker carrier, internally commoned; violet conductor entry; for Ex ec applications; gray

	Item No.	Pack. Unit
○ L ⑤	2022-2238/999-953	50

2-conductor/2-pin double-deck carrier terminal block; 2-conductor/2-pin through terminal block; with marker carrier, internally commoned; violet conductor entry;; for Ex ec applications; blue

	Item No.	Pack. Unit
● N ⑤	2022-2239/999-953	50

2-conductor/2-pin double-deck carrier block; 2-conductor/2-pin ground conductor block; with marker carrier; internally commoned; for Ex ec applications; green-yellow

	Item No.	Pack. Unit
● PE ⑤	2022-2237/999-953	50

2-conductor/2-pin double-deck carrier terminal block; 2-conductor/2-pin through terminal block; without marker carrier, internally commoned; violet conductor entry; for Ex ec applications; gray

○ L ⑤	2022-2208/999-953	50
-------	-------------------	----

2-conductor/2-pin double-deck carrier terminal block; 2-conductor/2-pin through terminal block; without marker carrier, internally commoned; violet conductor entry; for Ex ec applications; blue

● N ⑤	2022-2209/999-953	50
-------	-------------------	----

2-conductor/2-pin double-deck carrier block; 2-conductor/2-pin ground conductor block; without marker carrier; internally commoned; for Ex ec applications; green-yellow

● PE ⑤	2022-2207/999-953	50
--------	-------------------	----

1 Conductor range: 0.25 ... 4 mm² "s+f-st";
Push-in termination: 1 ... 4 mm² "s" and 1 ... 2.5 mm² "insulated ferrules, 12 mm"
Depending on the conductor characteristic, a conductor with a smaller cross section can also be inserted via push-in termination.

2 630 V = rated voltage for use in Zone 2 hazardous areas, "nA" type of protection with double-deck vertical jumper,

Note:

When used as intended, female plugs must not be connected/disconnected when live or under load.

Please observe the application notes:
Jumpers, from page 174
Marking, from page 640

Approvals and corresponding ratings, visit www.wago.com

Accessories; 2022 Series

Appropriate marking systems:
WMB/WMB Inline/Marking strips

End and intermediate plate; 1 mm thick

	orange	2022-2292	100 (25)
	gray	2022-2291	100 (25)

Insulation stop; 5 pcs/strip; 0.25 ... 0.5 mm²

	light gray	2002-171	200 (25)
---	------------	----------	----------

Insulation stop; 5 pcs/strip; 0.75 ... 1 mm²

	dark gray	2002-172	200 (25)
---	-----------	----------	----------

Protective warning marker; with black high-voltage symbol; for 5 terminal blocks

	yellow	2002-115	100 (25)
---	--------	----------	----------

Push-in type jumper bar; insulated; I_N 25 A; light gray

	2-way	2002-402	25
	3-way	2002-403	25
	4-way	2002-404	25
	5-way	2002-405	25
	6-way	2002-406	25
	7-way	2002-407	25
	8-way	2002-408	25
	9-way	2002-409	25
	10-way	2002-410	25

Push-in type jumper bar; insulated; I_N 25 A; light gray

	1 to 3	2002-433	25
	1 to 4	2002-434	25
	1 to 5	2002-435	25
	1 to 6	2002-436	25
	1 to 7	2002-437	25
	1 to 8	2002-438	25
	1 to 9	2002-439	25
	1 to 10	2002-440	25

Adjacent jumper for continuous commoning; insulated; I_N 25 A, light gray

	2-way	2002-400	25
---	-------	----------	----

Adjacent jumper for continuous commoning; insulated; I_N 25 A; 1 to 3

	light gray	2002-423	25
	red	2002-423/000-005	25
	blue	2002-423/000-006	25

Accessories; 2022 Series

Appropriate marking systems:
WMB/WMB Inline/Marking strips

Double-deck vertical jumper; insulated; I_N 24 A

	light gray	2002-492	100 (25)
	orange	2002-492/000-012	100 (25)

Carrier with 6 coding pins; for coding female plugs

	orange	2022-100	100 (25)
---	--------	----------	----------

Test pin; 1 mm Ø

		859-500	1
---	--	---------	---

Test plug adapter; for 4 mm Ø test plug

	gray	2009-174	100 (25)
---	------	----------	----------

Testing tap; for max. 2.5 mm²

	gray	2009-182	100 (25)
---	------	----------	----------

1-conductor female plug; with shorter locking lever; suitable for Ex ec applications; fits into carrier terminal blocks; codable

	gray	2022-103/999-953	100
--	------	------------------	-----

Marking strip; plain; 11 mm wide; 50 m reel

	white	2009-110	1
---	-------	----------	---

WMB Inline, plain; 1,500 WMB markers (5 mm)/reel; 5 ... 5.2 mm stretchable

	white	2009-115	1
---	-------	----------	---

WMB marking card; white; 10 strips with 10 markers/card; 5 ... 5.2 mm stretchable

	plain	793-5501	5
---	-------	----------	---

Double-deck marker carrier; pivoting

	gray	2002-121	50 (25)
---	------	----------	---------

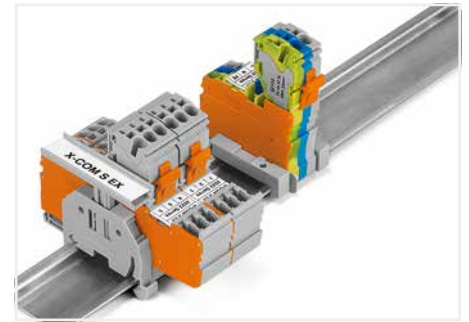

Group marking with height-adjustable group marker carrier (2009-163)

1-Conductor Female Plug X-COM®S-SYSTEM; for Ex ec Applications 2.5 (4) mm²; 2022 Series

Technical Data

0.25 ... 2.5 (4) mm² ①	22 ... 12 AWG
630 V ②	600 V, 20 A ③
I _N 20 A	600 V, 20 A ④
Module width: 5.2 mm / 0.205 inch	
10 ... 12 mm / 0.39 ... 0.47 inch	





- Conductor range: 0.25 ... 4 mm² "s+f-st"; Push-in termination: 1 ... 4 mm² "s" and 1 ... 2.5 mm² "insulated ferrules, 12 mm" Depending on the conductor characteristic, a conductor with a smaller cross section can also be inserted via push-in termination.
- 630 V = rated voltage for use in Zone 2 hazardous areas, "nA" type of protection

Approvals and corresponding ratings, visit www.wago.com

Accessories; for female plugs

Appropriate marking systems:
WMB/WMB Inline/Marking strips

Strain relief plate; gray

	35 mm wide	734-326	100 (25)
	6 mm wide	734-327	100 (25)
	12.5 mm wide	734-328	100 (25)
	25 mm wide	734-329	100 (25)
	55 mm wide	734-430	50 (25)
	75 mm wide	734-431	50 (25)

Marking strip; plain; 11 mm wide; 50 m reel

	white	2009-110	1
---	-------	----------	---

WMB Inline, plain; 1,500 WMB markers (5 mm)/reel; 5 ... 5.2 mm stretchable

	white	2009-115	1
--	-------	----------	---

WMB marking card; white; 10 strips with 10 markers/card; 5 ... 5.2 mm stretchable

	plain	793-5501	5
---	-------	----------	---



Dimensions (in mm):

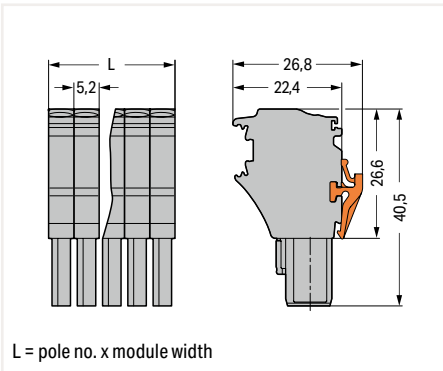

1-conductor female plug; with shorter locking lever; suitable for Ex ec applications; fits into carrier terminal blocks; codable; gray
According to EN 61984, pluggable connectors without a current interrupting capacity must not be mated or unmated when live or under load.

Pole No.	Item No.	Pack. Unit
2	2022-102/999-953	200
3	2022-103/999-953	100
4	2022-104/999-953	100
5	2022-105/999-953	50
6	2022-106/999-953	50
7	2022-107/999-953	50
8	2022-108/999-953	50

Accessories; for female plugs

Appropriate marking systems:
WMB/WMB Inline/Marking strips

Insulation stop; 5 pcs/strip; 0.25 ... 0.5 mm²

	light gray	2002-171	200 (25)
---	------------	----------	----------

Insulation stop; 5 pcs/strip; 0.75 ... 1 mm²

	dark gray	2002-172	200 (25)
---	-----------	----------	----------

Protective warning marker; with black high-voltage symbol; for 5 terminal blocks

	yellow	2002-115	100 (25)
---	--------	----------	----------

Carrier with 6 coding pins; for coding female plugs

	orange	2022-100	100 (25)
---	--------	----------	----------

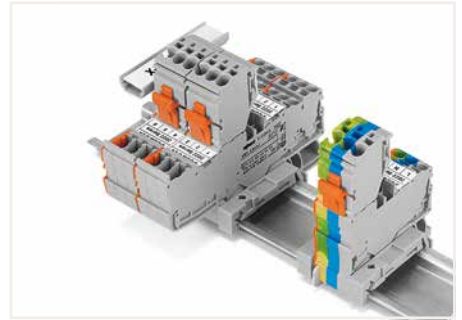

Each female plug is supplied with a locking lever.



Coding a female plug: remove coding finger using a suitable tool.

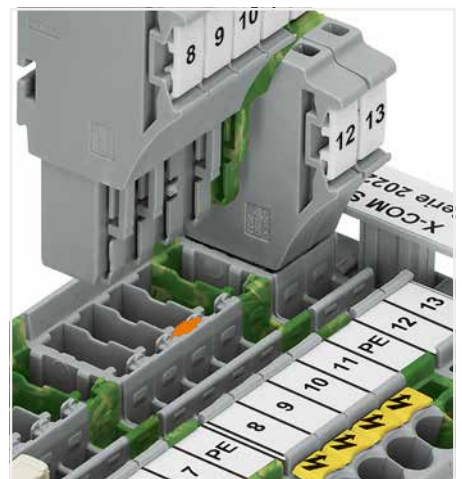

Insert a coding pin (2022-100) into the corresponding location of the carrier terminal block.

Pre-Assembled 1-Conductor Female Plug X-COM®S-SYSTEM; for Ex ec Applications 2.5 (4) mm²; 2022 Series

Technical Data	
0.25 ... 2.5 (4) mm ² ①	22 ... 12 AWG
630 V ②	600 V, 20 A
I _N 20 A	600 V, 20 A
Module width: 5.2 mm / 0.205 inch	
10 ... 12 mm / 0.39 ... 0.47 inch	



Technical Data	
0.25 ... 2.5 (4) mm ² ①	22 ... 12 AWG
630 V ②	600 V, 20 A
I _N 20 A	600 V, 20 A
Module width: 5.2 mm / 0.205 inch	
10 ... 12 mm / 0.39 ... 0.47 inch	



1-conductor female plug; with shorter locking lever; with ground base module (green-yellow); fits into carrier terminal blocks; codable

Pole No.	Item No.	Pack. Unit
3	2022-103/000-038/999-953	100
4	2022-104/000-038/999-953	100
5	2022-105/000-038/999-953	50
6	2022-106/000-038/999-953	50

1-conductor female plug; with shorter locking lever; with ground end module (green-yellow); fits into carrier terminal blocks; codable

Pole No.	Item No.	Pack. Unit
3	2022-103/000-039/999-953	100
4	2022-104/000-039/999-953	100
5	2022-105/000-039/999-953	50
6	2022-106/000-039/999-953	50

Accessories; for female plugs

Appropriate marking systems: WMB/WMB Inline/Marking strips

Insulation stop; 5 pcs/strip; 0.25 ... 0.5 mm²

	light gray	2002-171	200 (25)
--	------------	----------	----------

Insulation stop; 5 pcs/strip; 0.75 ... 1 mm²

	dark gray	2002-172	200 (25)
--	-----------	----------	----------

Protective warning marker; with black high-voltage symbol; for 5 terminal blocks

	yellow	2002-115	100 (25)
--	--------	----------	----------

Carrier with 6 coding pins; for coding female plugs

	orange	2022-100	100 (25)
--	--------	----------	----------

Strain relief plate; gray

	35 mm wide	734-326	100 (25)
	6 mm wide	734-327	100 (25)
	12.5 mm wide	734-328	100 (25)
	25 mm wide	734-329	100 (25)
	55 mm wide	734-430	50 (25)
	75 mm wide	734-431	50 (25)

Marking strip; plain; 11 mm wide; 50 m reel

	white	2009-110	1
--	-------	----------	---

WMB Inline, plain; 1,500 WMB markers (5 mm)/reel; 5 ... 5.2 mm stretchable

	white	2009-115	1
--	-------	----------	---

WMB marking card; white; 10 strips with 10 markers/card; 5 ... 5.2 mm stretchable

	plain	793-5501	5
--	-------	----------	---

① Conductor range: 0.25 ... 4 mm² "s+f-st"; Push-in termination: 1 ... 4 mm² "s" and 1 ... 2.5 mm² "insulated ferrules, 12 mm" Depending on the conductor characteristic, a conductor with a smaller cross section can also be inserted via push-in termination.

② 630 V = rated voltage for use in Zone 2 hazardous areas, "nA" type of protection

Note:

According to EN 61984, pluggable connectors without a current interrupting capacity must not be mated or unmated when live or under load.

Approvals and corresponding ratings, visit www.wago.com

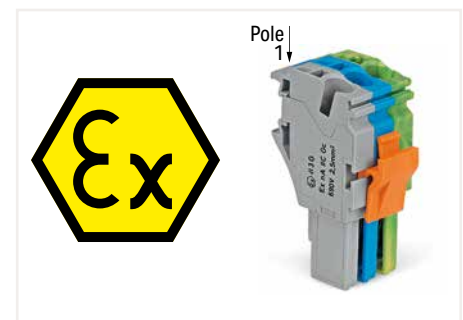

Ex marking:



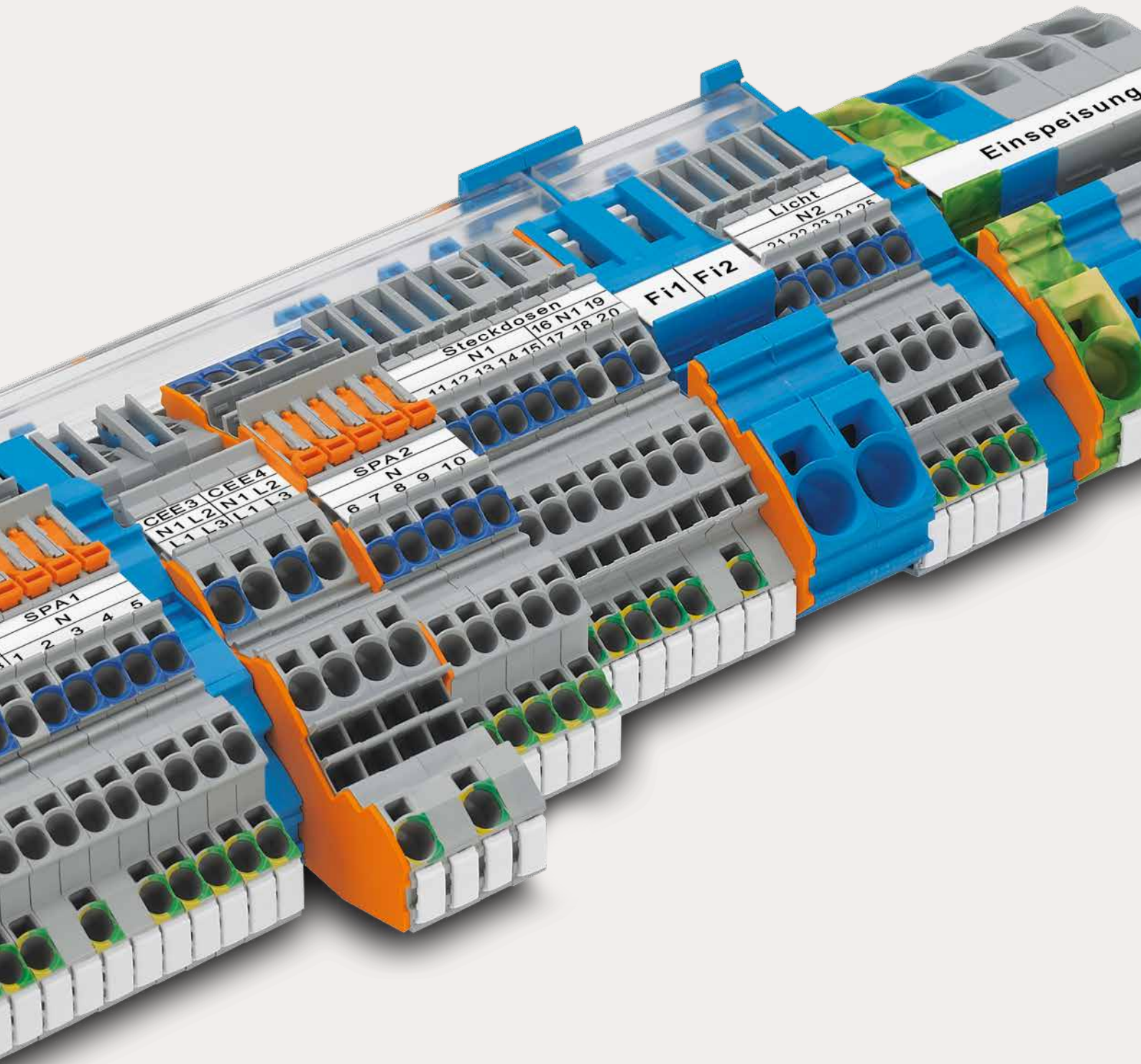



"Ex" sign and extended item number ".../999-953" are printed on the side of both carrier terminal blocks and female plugs with Ex approval. Shorter locking lever (factory-mounted) makes accidental disconnection more difficult.



WAGO Installation Rail-Mount Terminal Blocks TOPJOB® S

WAGO Installation Rail-Mount Terminal Blocks TOPJOB® S

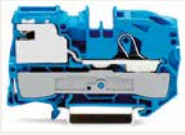
Front-Entry Wiring

			Page
	Multilevel Installation Terminal Blocks; with N-Disconnect Slide Links 0.25 ... 2.5 (4) mm ² (22 ... 12 AWG)	2003 Series	228
	Multilevel Installation Terminal Blocks; with Internal N-Disconnection 0.25 ... 2.5 (4) mm ² (22 ... 12 AWG)	2003 Series	230
	Double-Fuse Plugs on Carrier Terminal Blocks	2003 Series	234
	Multilevel Installation Terminal Blocks; with N-Disconnect Slide Links 0.5 ... 4 (6) mm ² (20 ... 10 AWG)	2005 Series	236
	N-Disconnect Terminal Blocks and Power Distribution Disconnect Terminal Blocks 0.5 ... 16 (25 "f-st") mm ² (20 ... 4 AWG)	2002/2006/2010/2016 Series	238
	Supply Terminal Blocks for Distribution Boxes 0.5 ... 16 (25 "f-st") mm ² (20 ... 4 AWG)	2016 Series	240
	Board Set	821 Series	242

Installation Rail-Mount Terminal Blocks TOPJOB® S

Installation

3



Inserting a conductor via push-in termination. Solid conductors with cross-sections from either one size above, or up to two sizes below, the rated cross-section can be simply pushed in – no tools needed.

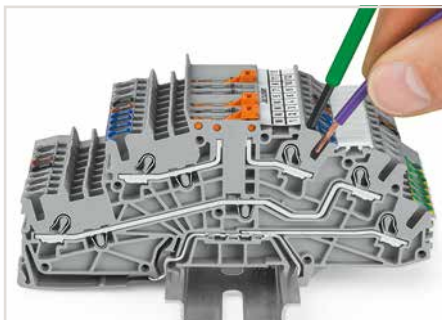

Inserting a conductor via operating tool. Connecting fine-stranded conductors without ferrules, or small cross-sectional conductors that cannot be pushed in, is performed similarly to the original CAGE CLAMP® – just use an operating tool.

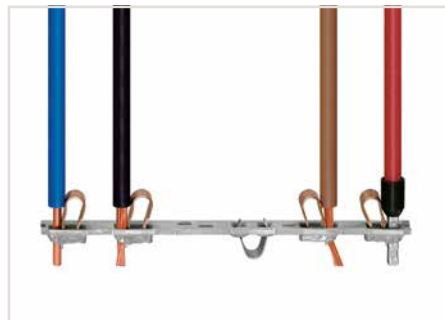

All conductor types at a glance

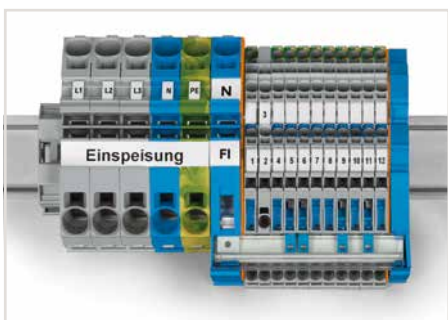

Mounting busbars on busbar carriers: Insert busbar ends onto large busbar carriers (2009-305) or onto supply terminal blocks with an integrated busbar carrier.

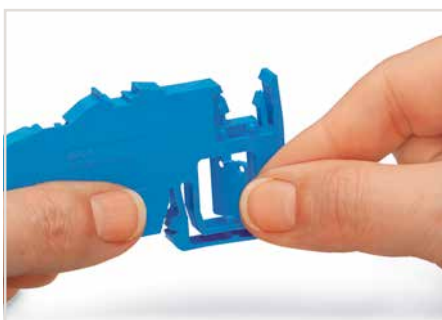

Removing the separator plate from the busbar carrier or from the N-disconnect terminal block.

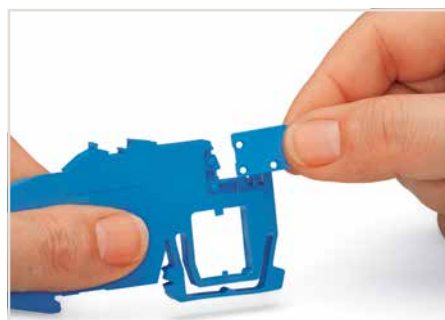

Inserting the separator plate into the busbar carrier to protect the N-busbar against accidental contact.

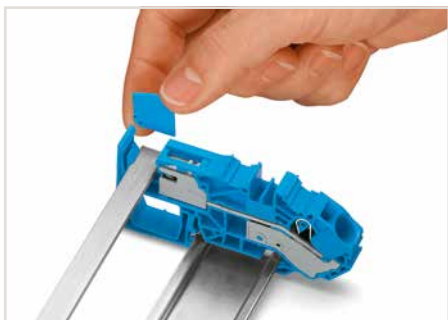

Inserting separator plate removed from N-disconnect terminal block.



Touch-proof N-busbar via inserted separator plate

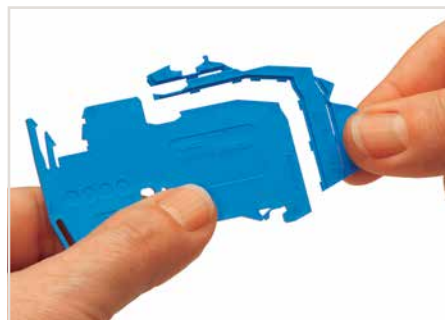

Perforations make it possible to fit the carrier to all Installation Rail-Mount Terminal Blocks TOPJOB® S using a single part.

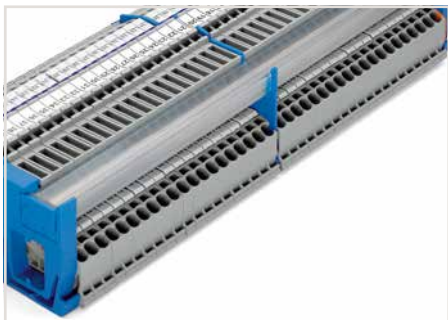

The compact busbar carrier (1.5 mm thick), which is placed every 200 mm, provides additional busbar support for longer assemblies.

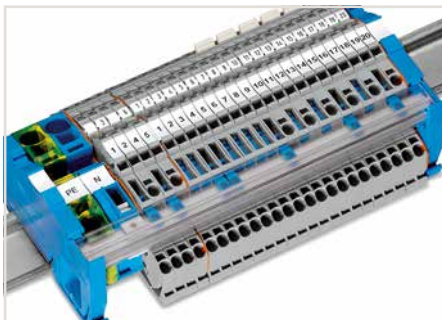

The busbar transparent cover (Item No. 777-303) protects the busbar against accidental contact and makes it easy to see which terminal blocks are connected to the busbar.



Tool-operated N-disconnect slide link



Push-in CAGE CLAMP® terminates the following copper conductors:
solid "s"



stranded "st"



fine-stranded "f-st", also with tinned single strands

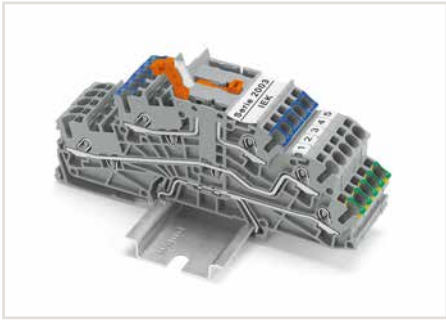

N-potential disconnection via N-knife disconnect within a terminal block assembly without a busbar.

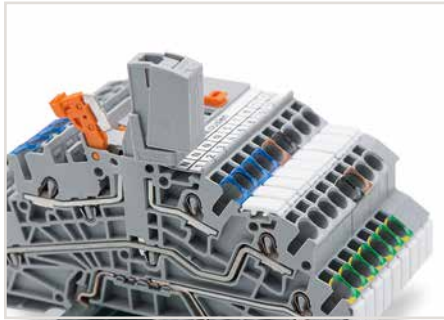

For multilevel installation terminal blocks with internal N-disconnection, test plug adapters can be inserted into the free vertical test slot when the N-potential is disconnected.

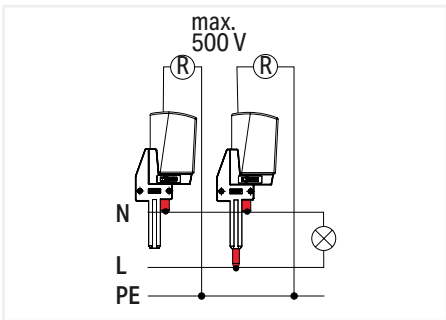

Test plug adapters for both individual N-potential measurement and insulation resistance measurement of the connected N- and L-potentials are available.

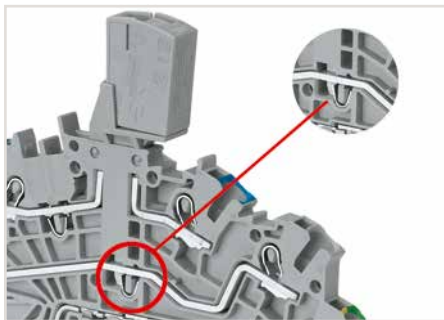

Multilevel installation terminal block fitted with an N/L-test plug adapter for quick and safe insulation resistance measurement of the connected N- and L-potentials

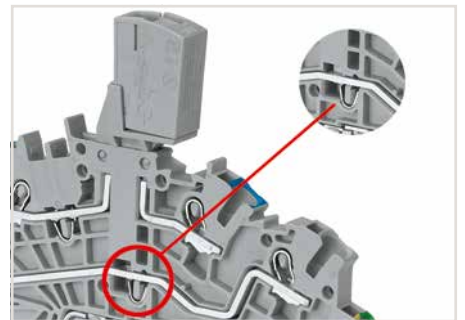

Multilevel installation terminal block fitted with an N-test plug adapter for insulation resistance measurement of the N-potential

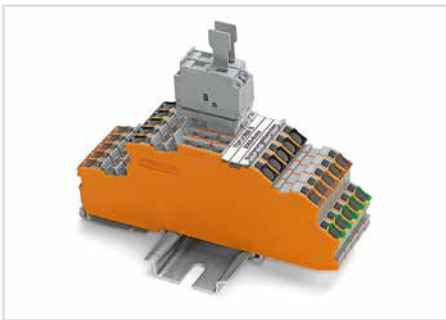

Single-fuse plugs can be used in combination with 1 mm thick end and intermediate plates on carrier terminal blocks without an N-knife disconnect.



Double-fuse plugs with 5 x 25 mm glass cartridge fuses can be used on carrier terminal blocks without an N-knife disconnect in standard terminal block width.



Commoning two potentials in one single jumper slot via extremely slim staggered jumpers.

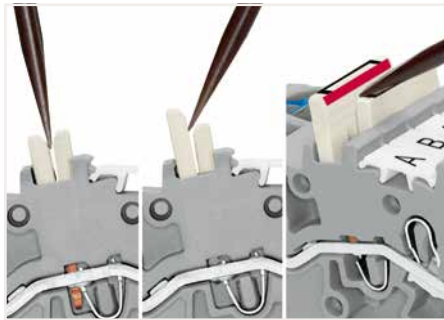

Insert the operating tool between the staggered jumpers, then lift up the jumper.



fine-stranded, tip-bonded



fine-stranded, with ferrule (gastight crimped)



fine-stranded, with pin terminal (gastight crimped)

Multilevel Installation Terminal Block TOPJOB® S; with N-Disconnect Slide Link

2.5 (4) mm²; 2003 Series

Technical Data

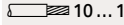
0.25 ... 2.5 (4) mm² ① | 22 ... 12 AWG
 250 V/4 kV/3; 24 A (32 A) ②
 400 V/6 kV/3; 24 A (32 A) ②
 Terminal block width: 5.2 mm / 0.205 inch
 10 ... 12 mm / 0.39 ... 0.47 inch

Technical Data

0.25 ... 2.5 (4) mm² ① | 22 ... 12 AWG
 400 V/6 kV/3 ②
 I_N 24 A (32 A)
 Terminal block width: 5.2 mm / 0.205 inch
 10 ... 12 mm / 0.39 ... 0.47 inch

① Conductor range: 0.25 ... 4 mm² "s+f-st";
 Push-in termination: 1 ... 4 mm² "s" and 1 ... 2.5 mm²
 "insulated ferrules, 12 mm"
 Depending on the conductor characteristic, a conductor with a smaller cross section can also be inserted via push-in termination.

② 250 V / 400 V = rated voltage
 4 kV / 6 kV = rated impulse voltage
 3 = pollution degree
 (see Section 15)
 250 V/4 kV potential – ground
 400 V/6 kV potential – potential

Please observe the application notes:
 Jumpers, from page 174
 Testing accessories, page 173
 Marking, from page 640

Approvals and corresponding ratings,
 visit www.wago.com

Accessories; 2003 Series

Appropriate marking systems:
 WMB/WMB Inline/Marking strips

2-conductor ground terminal block; 35 mm²; 16 mm wide



green-yellow 785-607 15

Connector; for busbar; with blue cover; 2.5 ... 16 mm²



blue 210-281 100 (50)

Connector; for busbar; 2.5 ... 35 mm²



unplated 209-105 50

Lock-out; prevents reclosing of slide link; snap-on type



orange 2003-7300 100 (25)

Insulation stop; 5 pcs/strip; 0.25 ... 0.5 mm²



light gray 2002-171 200 (25)

Insulation stop; 5 pcs/strip; 0.75 ... 1 mm²



dark gray 2002-172 200 (25)

Push-in type jumper bar; insulated; I_N 25 A; light gray



2-way	2002-402	25
3-way	2002-403	25
4-way	2002-404	25
5-way	2002-405	25
6-way	2002-406	25
7-way	2002-407	25
8-way	2002-408	25
9-way	2002-409	25
10-way	2002-410	25

Push-in type jumper bar; insulated; I_N 25 A; light gray



1 to 3	2002-433	25
1 to 4	2002-434	25
1 to 5	2002-435	25
1 to 6	2002-436	25
1 to 7	2002-437	25
1 to 8	2002-438	25
1 to 9	2002-439	25
1 to 10	2002-440	25

3

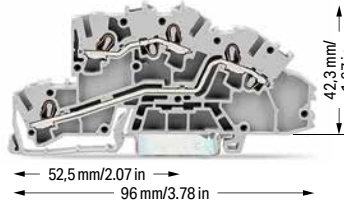
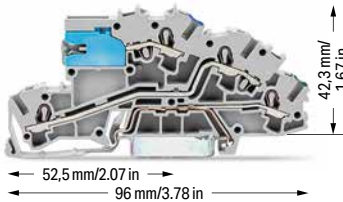

Multilevel installation terminal block; with N-disconnect slide link; gray

	Item No.	Pack. Unit
<input type="radio"/> NT/L/PE	2003-7641	50

Multilevel installation terminal block; gray

	Item No.	Pack. Unit
<input type="radio"/> L/L	2003-7642	50
<input type="radio"/> N/L	2003-7649	50

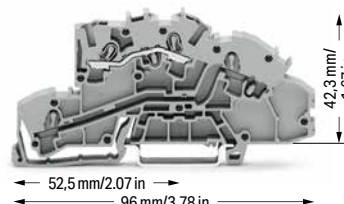
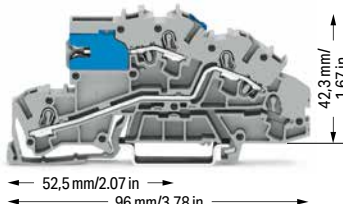

Multilevel installation terminal block; with N-disconnect slide link; gray

	Item No.	Pack. Unit
<input type="radio"/> NT/L	2003-7640	50
<input type="radio"/> LT/L	2003-7659	50

Multilevel installation terminal block; gray

	Item No.	Pack. Unit
<input type="radio"/> L	2003-7650	50
<input type="radio"/> N	2003-7651	50

Multilevel installation terminal block; gray

<input type="radio"/> N/L/PE	2003-7646	50
<input type="radio"/> L/L/PE	2003-7645	50

Accessories; 2003 Series

Appropriate marking systems: WMB/WMB Inline/Marking strips

End and intermediate plate; 0.8 mm thick



orange 2003-7692 100 (25)

Busbar cover; 1000 mm long



transparent 777-303 1

Busbar carrier; not suitable as an end stop; snaps onto DIN-35 rail; 1.5 mm thick



blue 2009-304 100 (25)

1-conductor N-disconnect terminal block; I_N 76 A; 16 mm²; 12 mm wide



blue 2016-7714 20

Busbar carrier; with end stop function and detachable separator plate; snaps onto DIN-35 rail; 7.5 mm thick



blue 2009-305 25

1-conductor N-disconnect terminal block; I_N 125 A; 35 mm²; 16 mm wide



blue 785-613 15

Busbar; tin-plated; 1000 mm long; copper (10 x 3) mm



I_N 140 A 210-133 1

2-conductor ground terminal block; 16 mm²; 12 mm wide



green-yellow 2016-7607 20

Accessories; 2003 Series

Appropriate marking systems:
WMB/WMB Inline/Marking strips

Adjacent jumper for continuous commoning; insulated;
I_N 25 A, light gray

	2-way	2002-400	25
---	-------	----------	----

Adjacent jumper for continuous commoning; insulated;
I_N 25 A; 1 to 3

	light gray	2002-423	25
	red	2002-423/000-005	25
	blue	2002-423/000-006	25

Staggered jumper; insulated; I_N 25 A; light gray

	2-way	2002-472	25
	3-way	2002-473	25
	4-way	2002-474	25
	5-way	2002-475	25
	6-way	2002-476	25
	7-way	2002-477	25
	8-way	2002-478	25
	9-way	2002-479	25
	10-way	2002-480	25
	11-way	2002-481	25
	12-way	2002-482	25

Customized staggered jumper; insulated; with contact
lugs broken off at the factory and circuit printing; I_N 25 A;
light gray

	1-3	2002-473/011-000	25
	1-3-5	2002-475/011-000	25
	1-3-5-7	2002-477/011-000	25
	1-3-5-7-9	2002-479/011-000	25
	1-3-5-7-9-11	2002-481/011-000	25

Push-in type wire jumper; insulated; 1.5 mm² conductor
cross-section; I_N 18 A

	L = 60 mm	2009-412	100 (10)
	L = 110 mm	2009-414	100 (10)
	L = 250 mm	2009-416	100 (10)

Test plug adapter; for 4 mm Ø test plug

	gray	2009-174	100 (25)
---	------	----------	----------

Testing tap; for max. 2.5 mm²

	gray	2009-182	100 (25)
---	------	----------	----------

Marking strip; plain; 11 mm wide; 50 m reel

	white	2009-110	1
---	-------	----------	---

WMB Inline, plain; 1,500 WMB markers (5 mm)/reel;
5 ... 5.2 mm stretchable

	white	2009-115	1
---	-------	----------	---

WMB marking card; white; 10 strips with 10 markers/card;
5 ... 5.2 mm stretchable

	plain	793-5501	5
---	-------	----------	---

Operating tool; 3.5 mm and 2.5 mm blade width; for
Installation Terminal Blocks TOPJOB® S

		2009-309	50 (1)
---	--	----------	--------

Accessories; 2003 Series

Appropriate marking systems:
WMB/WMB Inline/Marking strips

Operating tool; 3.5 mm and 5.5 mm blade width; for
Installation Terminal Blocks TOPJOB® S

		2009-310	50 (1)
---	--	----------	--------

Operating tool; blade 3.5 x 0.5 mm; with a partially
insulated shaft

		210-720	1
---	--	---------	---

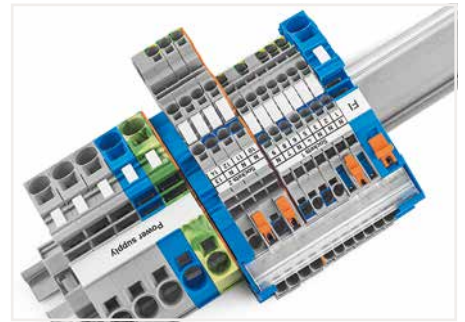

TOPJOB® S – Terminal Blocks for Every Application

- Push-in termination of solid conductors in small distribution boards saves time and money.
- Operating errors can be prevented as all Terminal Blocks for building installations are equipped with push-in connection technology.
- Using standard accessories reduces order-processing and warehousing costs.
- The busbar position is the same, making Installation Terminal Blocks TOPJOB® S compatible with standard Installation Terminal Blocks TOPJOB®.

For the construction and operation of power installations in fire-prone, hazardous locations or public buildings – such as conference centers, stores, hospitals, schools, theaters or hotels – the DIN VDE 0100-710 or DIN VDE 0100-718 standards shall be observed. DIN VDE 0100-482 shall also be observed for fire-prone, hazardous locations. These VDE regulations mandate that every neutral conductor must be provided with a disconnection device so, e.g., insulation resistance measurement is possible for every circuit without disconnecting the N-conductor. WAGO's N-disconnect terminal blocks meet this requirement.

Application note:

N-disconnect slide links, used in installation terminal blocks, consist of switch contacts that are opened and then closed again as part of regular circuit testing. To guarantee a reliable connection, a corrosion-resistant contact area is required on the N-busbar.

Historically, uninsulated copper busbars that have been cleaned/stripped of any possible corrosion before install can be used in dry, pollution-free locations.

According to DIN VDE 0100-520 (VDE 0100, Part 520), installation equipment exposed to contamination or corrosive substances (e.g., water) that promote corrosion or deterioration must be protected or made of a corrosion- or wear-resistant material. In these cases, tinned copper busbars guarantee a reliable connection.

WAGO only offers tinned copper busbars.

Multilevel Installation Terminal Block TOPJOB® S; with Internal N-Disconnection

2.5 (4) mm²; 2003 Series

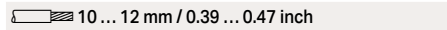
Technical Data	
0.25 ... 2.5 (4) mm ² ①	22 ... 12 AWG
250 V/4 kV/3; 20 A (25 A) ②	300 V, 20 A ③
400 V/6 kV/3; 20 A (25 A) ②	300 V, 20 A ④
Terminal block width: 5.2 mm / 0.205 inch	
 10 ... 12 mm / 0.39 ... 0.47 inch	

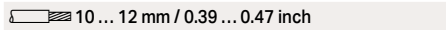
Technical Data	
0.25 ... 2.5 (4) mm ² ①	22 ... 12 AWG
400 V/6 kV/3 ②	300 V, 20 A ③
I _N 24 A (28 A)	300 V, 20 A ④
Terminal block width: 5.2 mm / 0.205 inch	
 10 ... 12 mm / 0.39 ... 0.47 inch	

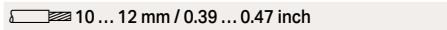
Technical Data	
0.25 ... 2.5 (4) mm ² ①	22 ... 12 AWG
250 V/4 kV/3; 24 A (28 A) ②	300 V, 20 A ③
400 V/6 kV/3; 24 A (28 A) ②	300 V, 20 A ④
Terminal block width: 5.2 mm / 0.205 inch	
 10 ... 12 mm / 0.39 ... 0.47 inch	

3

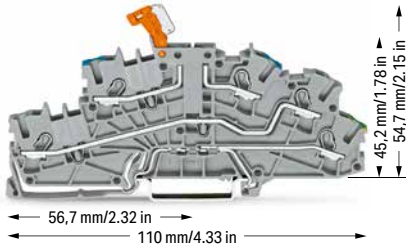

Multilevel installation terminal block; with pivoting knife disconnect; gray

	Item No.	Pack. Unit
<input type="radio"/> NT/L/PE	2003-6641	50
<input type="radio"/> LT/L/PE	2003-6644	50

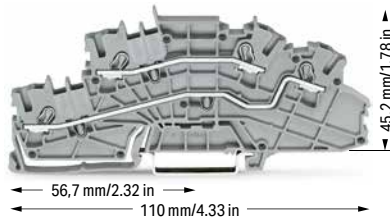

Multilevel installation terminal block; gray

	Item No.	Pack. Unit
<input type="radio"/> L/L	2003-6642	50
<input type="radio"/> N/L	2003-6649	50

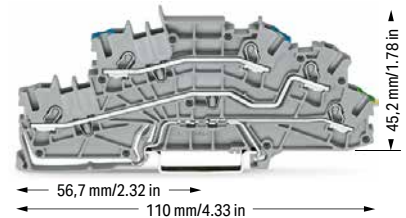

Multilevel installation terminal block; gray

	Item No.	Pack. Unit
<input type="radio"/> N/L/PE	2003-6646	50
<input type="radio"/> L/L/PE	2003-6645	50

Accessories; item-specific
N/L-test plug adapter; for vertical test slot; gray

	2-pole	2003-499	100 (25)
--	--------	----------	----------

N-test plug adapter; for vertical test slot; gray

	1-pole	2003-500	100 (25)
---	--------	----------	----------

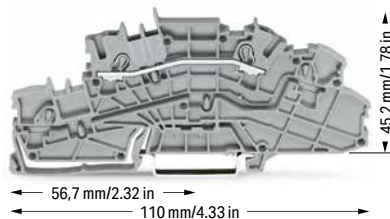

Multilevel installation terminal block; gray

	Item No.	Pack. Unit
<input type="radio"/> L	2003-6650	50
<input type="radio"/> N	2003-6651	50

Accessories; 2003 Series

Appropriate marking systems: WMB/WMB Inline/Marking strips

End and intermediate plate; 0.8 mm thick

	orange	2003-6692	100 (25)
--	--------	-----------	----------

Insulation stop; 5 pcs/strip; 0.25 ... 0.5 mm²

	light gray	2002-171	200 (25)
--	------------	----------	----------

Insulation stop; 5 pcs/strip; 0.75 ... 1 mm²

	dark gray	2002-172	200 (25)
--	-----------	----------	----------

Push-in type jumper bar; insulated; I_N 25 A; light gray

	2-way	2002-402	25
	3-way	2002-403	25
	4-way	2002-404	25
	5-way	2002-405	25
	6-way	2002-406	25
	7-way	2002-407	25
	8-way	2002-408	25
	9-way	2002-409	25
	10-way	2002-410	25

Push-in type jumper bar; insulated; I_N 25 A; light gray

	1 to 3	2002-433	25
	1 to 4	2002-434	25
	1 to 5	2002-435	25
	1 to 6	2002-436	25
	1 to 7	2002-437	25
	1 to 8	2002-438	25
	1 to 9	2002-439	25
	1 to 10	2002-440	25

Push-in type wire jumper; insulated; 1.5 mm² conductor cross-section; I_N 18 A

	L = 60 mm	2009-412	100 (10)
	L = 110 mm	2009-414	100 (10)
	L = 250 mm	2009-416	100 (10)

❶ Conductor range: 0.25 ... 4 mm² "s+f-st";
Push-in termination: 1 ... 4 mm² "s" and 1 ... 2.5 mm² "insulated ferrules, 12 mm"
Depending on the conductor characteristic, a conductor with a smaller cross section can also be inserted via push-in termination.

❷ 250 V / 400 V = rated voltage
4 kV / 6 kV = rated impulse voltage
3 = pollution degree
(see Section 15)
250 V/4 kV potential – ground
400 V/6 kV potential – potential

Please observe the application notes:
Jumpers, from page 174
Testing accessories, page 173
Marking, from page 640

Approvals and corresponding ratings, visit www.wago.com

Accessories; 2003 Series

Appropriate marking systems:
WMB/WMB Inline/Marking strips

Staggered jumper; insulated; I _N 25 A; light gray			
	2-way	2002-472	25
	3-way	2002-473	25
	4-way	2002-474	25
	5-way	2002-475	25
	6-way	2002-476	25
	7-way	2002-477	25
	8-way	2002-478	25
	9-way	2002-479	25
	10-way	2002-480	25
	11-way	2002-481	25
	12-way	2002-482	25

Customized staggered jumper; insulated; with contact lugs broken off at the factory and circuit printing; I_N 25 A; light gray

	1-3	2002-473/011-000	25
	1-3-5	2002-475/011-000	25
	1-3-5-7	2002-477/011-000	25
	1-3-5-7-9	2002-479/011-000	25
	1-3-5-7-9-11	2002-481/011-000	25

Adjacent jumper for continuous commoning; insulated; I_N 25 A, light gray

	2-way	2002-400	25
---	-------	----------	----

Adjacent jumper for continuous commoning; insulated; I_N 25 A; 1 to 3

	light gray	2002-423	25
	red	2002-423/000-005	25
	blue	2002-423/000-006	25

Test plug adapter; for 4 mm Ø test plug

	gray	2009-174	100 (25)
---	------	----------	----------

Testing tap; for max. 2.5 mm²

	gray	2009-182	100 (25)
---	------	----------	----------

Accessories; 2003 Series

Appropriate marking systems:
WMB/WMB Inline/Marking strips

Marking strip; plain; 11 mm wide; 50 m reel

	white	2009-110	1
---	-------	----------	---

WMB Inline, plain; 1,500 WMB markers (5 mm)/reel; 5 ... 5.2 mm stretchable

	white	2009-115	1
---	-------	----------	---

WMB marking card; white; 10 strips with 10 markers/card; 5 ... 5.2 mm stretchable

	plain	793-5501	5
---	-------	----------	---

Operating tool; 3.5 mm and 2.5 mm blade width; for Installation Terminal Blocks TOPJOB® S

		2009-309	50 (1)
---	--	----------	--------

Operating tool; 3.5 mm and 5.5 mm blade width; for Installation Terminal Blocks TOPJOB® S

		2009-310	50 (1)
---	--	----------	--------

Operating tool; blade 3.5 x 0.5 mm; with a partially insulated shaft

		210-720	1
---	--	---------	---

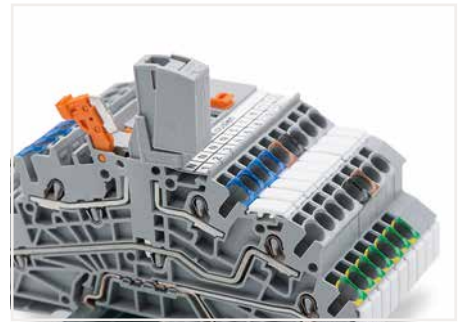

For multilevel installation terminal blocks with internal N-disconnection, test plug adapters can be inserted into the free vertical test slot when the N-potential is disconnected.

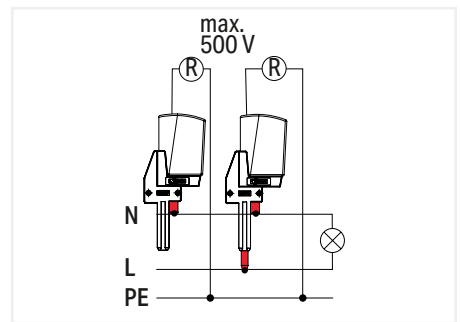



Test plug adapters for both individual N-potential measurement and insulation resistance measurement of the connected N- and L-potentials are available.

3

Multilevel Installation Terminal Block TOPJOB® S

2.5 (4) mm²; 2003 Series

Technical Data	
0.25 ... 2.5 (4) mm ² ①	22 ... 12 AWG
250 V/4 kV/3; 20 A (25 A) ②	250 V, 6,3 A ③
400 V/6 kV/3; 20 A (25 A) ②	300 V, 20 A ④
Terminal block width: 5.2 mm / 0.205 inch	
 10 ... 12 mm / 0.39 ... 0.47 inch	

Technical Data	
0.25 ... 2.5 (4) mm ² ①	22 ... 12 AWG
250 V/4 kV/3; 20 A (25 A) ②	250 V, 6,3 A ③
400 V/6 kV/3; 20 A (25 A) ②	300 V, 20 A ④
Terminal block width: 5.2 mm / 0.205 inch	
 10 ... 12 mm / 0.39 ... 0.47 inch	

① Conductor range: 0.25 ... 4 mm² "s+f-st"; Push-in termination: 1 ... 4 mm² "s" and 1 ... 2.5 mm² "insulated ferrules, 12 mm"
Depending on the conductor characteristic, a conductor with a smaller cross section can also be inserted via push-in termination.

② 250 V / 400 V = rated voltage
4 kV / 6 kV = rated impulse voltage
3 = pollution degree (see Section 15)
250 V/4 kV potential – ground
400 V/6 kV potential – potential
Maximum current depends on accessories used.

Please observe the application notes:
Jumpers, from page 174
Testing accessories, page 173
Marking, from page 640

Approvals and corresponding ratings, visit www.wago.com

3

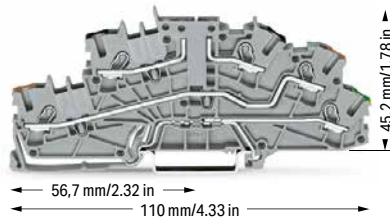
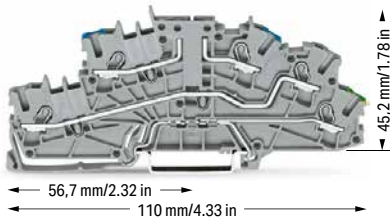

Multilevel installation terminal block; carrier terminal block without knife disconnect; gray

	Item No.	Pack. Unit
○ N/L/PE	2003-6640	50
○ L/L/PE	2003-6662	50

Multilevel installation terminal block; carrier terminal block without knife disconnect; black upper-deck, brown middle-deck, green-yellow lower-deck printing

	Item No.	Pack. Unit
○ P2/P1/PE	2003-6643	50

Multilevel installation terminal block; carrier terminal block without knife disconnect; blue middle-deck, green-yellow lower-deck printing; gray

	Item No.	Pack. Unit
○ L/N/PE	2003-6661	50

Multilevel installation terminal block; carrier terminal block without knife disconnect; brown upper-deck, black middle-deck, green-yellow lower-deck printing

	Item No.	Pack. Unit
○ P1/P2/PE	2003-6660	50

Accessories; 2003 Series

Appropriate marking systems: WMB/WMB Inline/Marking strips

N/L-test plug adapter; for vertical test slot; gray

	2-pole	2003-499	100 (25)
---	--------	----------	----------

N-test plug adapter; for vertical test slot; gray

	1-pole	2003-500	100 (25)
---	--------	----------	----------

End and intermediate plate; 0.8 mm thick

	orange	2003-6692	100 (25)
---	--------	-----------	----------

Fuse plug with pull-tab; for 5 x 20 mm glass cartridge fuse
Electrical ratings are given by the fuse.

	gray	2004-911	50
---	------	----------	----

End and intermediate plate; only for use with fuse plugs; 1 mm thick

	orange	2003-6693	100 (25)
---	--------	-----------	----------

Double-fuse plug; for 5 x 20 mm glass cartridge fuse
Electrical ratings are given by the fuse.

	gray	2003-911	25
---	------	----------	----

End and intermediate plate; 1 mm thick; only for use with double-fuse plugs

	orange	2003-6694	100 (25)
--	--------	-----------	----------

Push-in type jumper bar; insulated; I_N 25 A; light gray

	2-way	2002-402	25
	3-way	2002-403	25
	4-way	2002-404	25
	5-way	2002-405	25
	6-way	2002-406	25
	7-way	2002-407	25
	8-way	2002-408	25
	9-way	2002-409	25
	10-way	2002-410	25

Push-in type jumper bar; insulated; I_N 25 A; light gray

	1 to 3	2002-433	25
	1 to 4	2002-434	25
	1 to 5	2002-435	25
	1 to 6	2002-436	25
	1 to 7	2002-437	25
	1 to 8	2002-438	25
	1 to 9	2002-439	25
	1 to 10	2002-440	25

Push-in type wire jumper; insulated; 1.5 mm² conductor cross-section; I_N 18 A

	L = 60 mm	2009-412	100 (10)
	L = 110 mm	2009-414	100 (10)
	L = 250 mm	2009-416	100 (10)

Accessories; 2003 Series

Appropriate marking systems:
WMB/WMB Inline/Marking strips

Staggered jumper; insulated; I_N 25 A; light gray

	2-way	2002-472	25
	3-way	2002-473	25
	4-way	2002-474	25
	5-way	2002-475	25
	6-way	2002-476	25
	7-way	2002-477	25
	8-way	2002-478	25
	9-way	2002-479	25
	10-way	2002-480	25
	11-way	2002-481	25
	12-way	2002-482	25

Customized staggered jumper; insulated; with contact lugs broken off at the factory and circuit printing; I_N 25 A; light gray

	1-3	2002-473/011-000	25
	1-3-5	2002-475/011-000	25
	1-3-5-7	2002-477/011-000	25
	1-3-5-7-9	2002-479/011-000	25
	1-3-5-7-9-11	2002-481/011-000	25

Adjacent jumper for continuous commoning; insulated; I_N 25 A, light gray

	2-way	2002-400	25
---	-------	----------	----

Adjacent jumper for continuous commoning; insulated; I_N 25 A; 1 to 3

	light gray	2002-423	25
	red	2002-423/000-005	25
	blue	2002-423/000-006	25

Test plug adapter; for 4 mm Ø test plug

	gray	2009-174	100 (25)
---	------	----------	----------

Testing tap; for max. 2.5 mm²

	gray	2009-182	100 (25)
---	------	----------	----------

Accessories; 2003 Series

Appropriate marking systems:
WMB/WMB Inline/Marking strips

Marking strip; plain; 11 mm wide; 50 m reel

white 2009-110 1

WMB Inline, plain; 1,500 WMB markers (5 mm)/reel;
5 ... 5.2 mm stretchable

white 2009-115 1

WMB marking card; white; 10 strips with 10 markers/card;
5 ... 5.2 mm stretchable

plain 793-5501 5

Operating tool; 3.5 mm and 2.5 mm blade width; for
Installation Terminal Blocks TOPJOB® S

2009-309 50 (1)

Operating tool; 3.5 mm and 5.5 mm blade width; for
Installation Terminal Blocks TOPJOB® S

2009-310 50 (1)

Operating tool; blade 3.5 x 0.5 mm; with a partially
insulated shaft

210-720 1

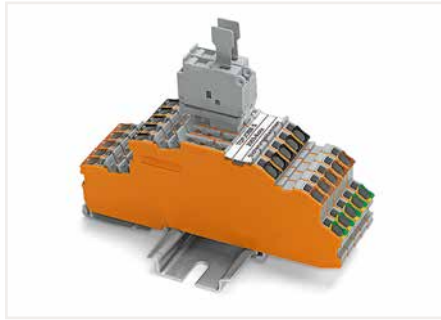

Single-fuse plugs can be used in combination with 1 mm thick end and intermediate plates on carrier terminal blocks without an N-knife disconnect.

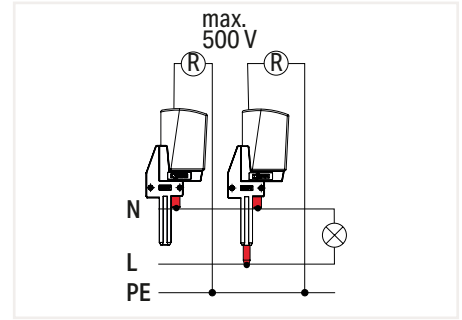

Test plug adapters for both individual N-potential measurement and insulation resistance measurement of the connected N- and L-potentials are available.

3

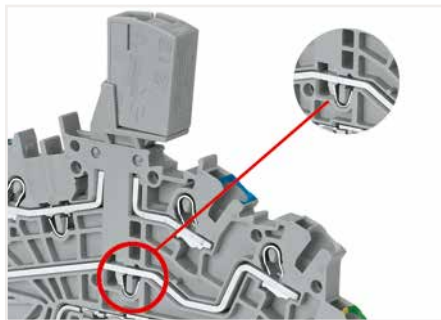

Multilevel installation terminal block fitted with an N/L-test plug adapter for quick and safe insulation resistance measurement of the connected N- and L-potentials

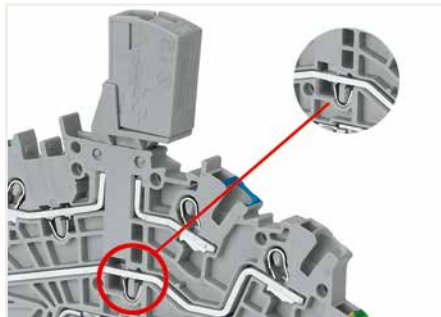

Multilevel installation terminal block fitted with an N-test plug adapter for insulation resistance measurement of the N-potential

Double-Fuse Plug TOPJOB® S on Carrier Terminal Block 2.5 (4) mm² 2003 Series

Technical Data

250 V / I_N 6.3 A
Plug width: 10.4 mm / 0.409 inch



Technical Data

250 V / I_N 6.3 A
Plug width: 10.4 mm / 0.409 inch

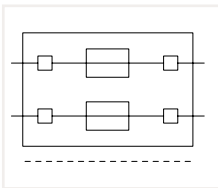

Double-fuse plug; for 5 x 20 mm glass cartridge fuse
Electrical ratings are given by the fuse.

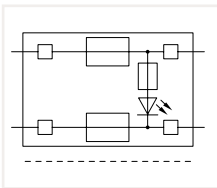

Double-fuse plug; for 5 x 20 mm glass cartridge fuse; with LED; gray
Electrical ratings are given by the fuse and blown fuse indication. Leakage current in case of a blown fuse: LED 0.25 mA

Color	Item No.	Pack. Unit
○ gray	2003-911	50

Color	Item No.	Pack. Unit
○ 230 V	2003-911/1000-923	50

Accessories; for fuse plugs

Appropriate marking systems: WMB/Marking strips

2-conductor carrier terminal block;
0.25 ... 2.5 (4) mm² / 22 ... 12 AWG
Terminal block width: 5.2 mm / 0.205 inch

	gray	2002-1661	50
--	------	-----------	----

2-conductor carrier terminal block;
0.25 ... 2.5 (4) mm² / 22 ... 12 AWG
Terminal block width: 5.2 mm / 0.205 inch

	gray	2002-1961	50
--	------	-----------	----

End and intermediate plate; 1 mm thick

	orange	2002-1692	100 (25)
	gray	2002-1691	100 (25)

End and intermediate plate; 1 mm thick

	orange	2002-1992	100 (25)
	gray	2002-1991	100 (25)

3-conductor carrier terminal block;
0.25 ... 2.5 (4) mm² / 22 ... 12 AWG
Terminal block width: 5.2 mm / 0.205 inch

	gray	2002-1761	50
--	------	-----------	----

Double-deck carrier terminal block;
0.25 ... 2.5 (4) mm² / 22 ... 12 AWG
Terminal block width: 5.2 mm / 0.205 inch

	L/L	2002-2961	50
--	-----	-----------	----

End and intermediate plate; 1 mm thick

	orange	2002-1792	100 (25)
	gray	2002-1791	100 (25)

Double-deck carrier terminal block;
0.25 ... 2.5 (4) mm² / 22 ... 12 AWG
Terminal block width: 5.2 mm / 0.205 inch

	L/N	2002-2963	50
--	-----	-----------	----

4-conductor carrier terminal block;
0.25 ... 2.5 (4) mm² / 22 ... 12 AWG
Terminal block width: 5.2 mm / 0.205 inch

	gray	2002-1861	50
--	------	-----------	----

Double-deck carrier terminal block;
0.25 ... 2.5 (4) mm² / 22 ... 12 AWG
Terminal block width: 5.2 mm / 0.205 inch

	L/L	2002-2941	50
--	-----	-----------	----

End and intermediate plate; 1 mm thick

	orange	2002-1892	100 (25)
	gray	2002-1891	100 (25)

End and intermediate plate; 1 mm thick

	orange	2002-2992	100 (25)
	gray	2002-2991	100 (25)

End plate for fuse terminal blocks; 2 mm thick

	orange	2002-992	100 (25)
	gray	2002-991	100 (25)

Shorting link; 5 x 20 mm; allows the fuse plug to be used as a disconnect plug

	I _N 6.3 A	281-503	250 (25)
--	----------------------	---------	----------

Length for 2002-1661 – 66.5 mm / 2.62 inch
2-conductor carrier terminal block

Length for 2002-1761 – 76.8 mm / 3.02 inch
3-conductor carrier terminal block

Length for 2002-1861 – 87.5 mm / 3.45 inch
4-conductor carrier terminal block

Length for 2002-1961 – 72.9 mm / 2.87 inch
2-conductor carrier terminal block with additional jumper slot

Length for 2002-2961 – 108 mm / 4.25 inch
Double-deck carrier terminal block

Length for 2003-6640 – 110 mm / 4.33 inch
Multilevel Installation Terminal Block

Approvals and corresponding ratings, visit www.wago.com

Accessories; for fuse plugs

Appropriate marking systems:
WMB/Marking strips

Multilevel installation terminal block;
0.25 ... 2.5 (4) mm² / 22 ... 12 AWG
Terminal block width: 5.2 mm / 0.205 inch

	N/L/PE	2003-6640	50
--	--------	-----------	----

Multilevel installation terminal block;
0.25 ... 2.5 (4) mm² / 22 ... 12 AWG
Terminal block width: 5.2 mm / 0.205 inch

	L/N/PE	2003-6661	50
--	--------	-----------	----

Multilevel installation terminal block;
0.25 ... 2.5 (4) mm² / 22 ... 12 AWG
Terminal block width: 5.2 mm / 0.205 inch

	P2/P1/PE	2003-6643	50
--	----------	-----------	----

Multilevel installation terminal block;
0.25 ... 2.5 (4) mm² / 22 ... 12 AWG
Terminal block width: 5.2 mm / 0.205 inch

	P1/P2/PE	2003-6660	50
--	----------	-----------	----

End and intermediate plate; 0.8 mm thick

	orange	2003-6692	100 (25)
--	--------	-----------	----------

End and intermediate plate; 1 mm thick; only for use with double-fuse plugs

	orange	2003-6694	100 (25)
--	--------	-----------	----------

WMB marking card; white; 10 strips with 10 markers/card; 5 ... 5.2 mm stretchable

	plain	793-5501	5
--	-------	----------	---

WMB marking card; white; 10 strips with 10 markers/card; 5 ... 5.2 mm stretchable

	F1, ..., F10 (10x)	794-5615	5
	F11, ..., F20 (10x)	794-5616	5
	F21, ..., F30 (10x)	794-5617	5
	F31, ..., F40 (10x)	794-5618	5
	F41, ..., F50 (10x)	794-5619	5



Double-fuse plugs with 5 x 25 mm glass cartridge fuses can be used on carrier terminal blocks without an N-knife disconnect in standard terminal block width.

Glass cartridge fuses 5 x 20

Series Item No.	Overload and short circuit protection		Short circuit protection only	
	Individual argmt.	Group argmt.	Individual argmt.	Group argmt.
Fuse terminal blocks				
2003-911				
2003-911/.....	1.6 W	1.6 W	2.5 W	2.5 W

When selecting glass cartridge fuses, make sure that the maximum power loss listed below is not exceeded. The power loss is determined according to IEC or EN 60947-7-3/VDE 0611-6 at 23°C. The temperature rise of the terminal blocks must be checked according to their application and mounting. Higher ambient temperatures represent an additional impact on fuse cartridges. Therefore, in such applications, the rated current must be reduced if necessary. More details are available from the manufacturers.

Multilevel Installation Terminal Block TOPJOB® S; with N-Disconnect Slide Link 4 (6) mm²; 2005 Series

Technical Data	
0.5 ... 4 (6) mm ² ①	20 ... 10 AWG
250 V/4 kV/3; 32 A (36 A) ②	
400 V/6 kV/3; 32 A (36 A) ②	
Terminal block width: 6.2 mm / 0.244 inch	
 11 ... 13 mm / 0.43 ... 0.51 inch	

Technical Data	
0.5 ... 4 (6) mm ² ①	20 ... 10 AWG
400 V/6 kV/3 ②	
I _N 32 A (36 A)	
Terminal block width: 6.2 mm / 0.244 inch	
 11 ... 13 mm / 0.43 ... 0.51 inch	

Technical Data	
0.5 ... 4 (6) mm ² ①	20 ... 10 AWG
250 V/4 kV/3; 32 A (36 A) ②	
400 V/6 kV/3; 32 A (36 A) ②	
Terminal block width: 6.2 mm / 0.244 inch	
 11 ... 13 mm / 0.43 ... 0.51 inch	

3

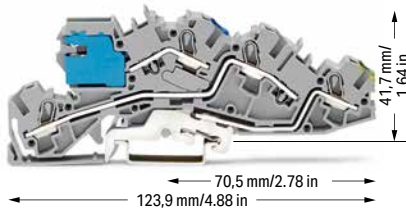

Multilevel installation terminal block; with N-disconnect slide link; gray

	Bestellnr.	VPE
○ NT/L/PE	2005-7641	50

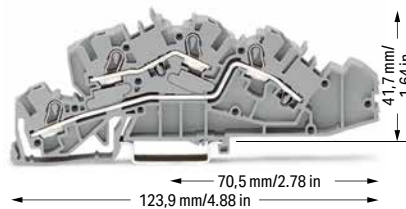

Multilevel installation terminal block; gray

	Bestellnr.	VPE
○ L/L	2005-7642	50
○ N/L	2005-7649	50

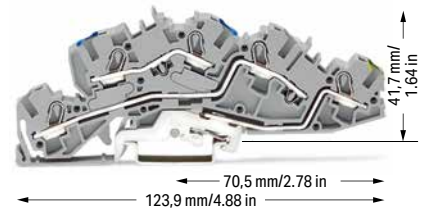

Multilevel installation terminal block; gray

	Bestellnr.	VPE
○ N/L/PE	2005-7646	50
○ L/L/PE	2005-7645	50

Accessories; 2005 Series

Appropriate marking systems: WMB/Marking strips

End and intermediate plate; 1 mm thick

 orange	2005-7692	100 (25)
--	-----------	----------

Busbar carrier; not suitable as an end stop; snaps onto DIN-35 rail; 1.5 mm thick

 blue	2009-304	100 (25)
---	----------	----------

Busbar carrier; with end stop function and detachable separator plate; snaps onto DIN-35 rail; 7.5 mm thick

 blue	2009-305	25
---	----------	----

Busbar; tin-plated; 1000 mm long; copper (10 x 3) mm

 I _N 140 A	210-133	1
---	---------	---

Busbar cover; 1000 mm long

 transparent	777-303	1
--	---------	---

Lock-out; prevents reclosing of slide link; snap-on type

 orange	2005-7300	100 (25)
---	-----------	----------

1-conductor N-disconnect terminal block; I_N 76 A; 16 mm²; 12 mm wide

 blue	2016-7714	20
---	-----------	----

1-conductor N-disconnect terminal block; I_N 125 A; 35 mm²; 16 mm wide

 blue	785-613	15
---	---------	----

2-conductor ground terminal block; 16 mm²; 12 mm wide

 green-yellow	2016-7607	20
---	-----------	----

2-conductor ground terminal block; 35 mm²; 16 mm wide

 green-yellow	785-607	15
---	---------	----

Connector; for busbar; with blue cover; 2.5 ... 16 mm²

 blue	210-281	100 (50)
--	---------	----------

Connector; for busbar; 2.5 ... 35 mm²

 unplated	209-105	50
--	---------	----









Insulation stop; 5 pcs/strip; 0.25 ... 0.5 mm²

 light gray	2004-171	200 (25)
--	----------	----------









Insulation stop; 5 pcs/strip; 0.75 ... 1 mm²

 dark gray	2004-172	200 (25)
---	----------	----------

Push-in type jumper bar; insulated; I_N 32 A; light gray

 2-way	2004-402	25
 3-way	2004-403	25
 4-way	2004-404	25
 5-way	2004-405	25
 6-way	2004-406	25
 7-way	2004-407	25
 8-way	2004-408	25
 9-way	2004-409	25
 10-way	2004-410	25

Push-in type jumper bar; insulated; I_N 32 A; light gray

 1 to 3	2004-433	25
 1 to 4	2004-434	25
 1 to 5	2004-435	25
 1 to 6	2004-436	25
 1 to 7	2004-437	25
 1 to 8	2004-438	25
 1 to 9	2004-439	25
 1 to 10	2004-440	25

Test plug adapter; for 4 mm Ø test plug

 gray	2009-174	100 (25)
--	----------	----------

Testing tap; for max. 2.5 mm²

 gray	2009-182	100 (25)
--	----------	----------

Marking strip; plain; 11 mm wide; 50 m reel

 white	2009-110	1
---	----------	---

WMB marking card; white; 10 strips with 10 markers/card; 5 ... 5.2 mm stretchable

 plain	793-5501	5
---	----------	---

Operating tool; 3.5 mm and 2.5 mm blade width; for Installation Terminal Blocks TOPJOB® S

 2009-309	50 (1)
--	--------

Operating tool; 3.5 mm and 5.5 mm blade width; for Installation Terminal Blocks TOPJOB® S

 2009-310	50 (1)
--	--------

Operating tool; blade 3.5 x 0.5 mm; with a partially insulated shaft

 210-720	1
---	---

① Conductor range: 0.5 ... 6 mm² "s+f-st";
 Push-in termination: 1.5 ... 6 mm² "s" and 1.5 ... 4 mm²
 "insulated ferrules; 12 mm"
 Depending on the conductor characteristic, a conductor
 with a smaller cross section can also be inserted
 via push-in termination.

② 250 V/400 V = rated voltage
 4 kV/6 kV = rated impulse voltage
 3 = pollution degree
 (see Section 15)
 250 V/4 kV potential – ground
 400 V/6 kV potential – potential

Please observe the application notes:
 Testing accessories, page 173
 Marking, from page 640

Approvals and corresponding ratings,
 visit www.wago.com

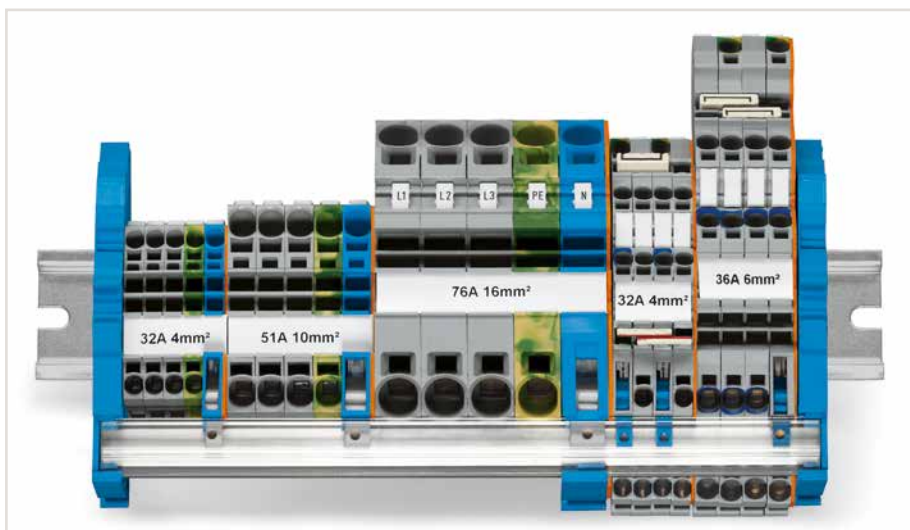

Application note:

N-disconnect slide links, used in installation terminal blocks, consist of switch contacts that are opened and then closed again as part of regular circuit testing. To guarantee a reliable connection, a corrosion-resistant contact area is required on the N-busbar.

Historically, uninsulated copper busbars that have been cleaned/stripped of any possible corrosion before install can be used in dry, pollution-free locations.

According to DIN VDE 0100-520 (VDE 0100, Part 520), installation equipment exposed to contamination or corrosive substances (e.g., water) that promote corrosion or deterioration must be protected or made of a corrosion- or wear-resistant material. In these cases, tinned copper busbars guarantee a reliable connection.

WAGO only offers tinned copper busbars.

N-Disconnect Terminal Block, Power Distribution Disconnect Terminal Block TOPJOB® S 2002 Series; 2006 Series; 2010 Series; 2016 Series

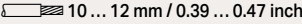
Technical Data	
0.25 ... 2.5 (4) mm ² ①	22 ... 12 AWG
250 V/4 kV/3 ⑤	
I _N 32 A	
Terminal block width: 5.2 mm / 0.205 inch	
 10 ... 12 mm / 0.39 ... 0.47 inch	

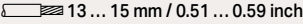
Technical Data	
0.5 ... 6 (10) mm ² ②	20 ... 8 AWG
250 V/4 kV/3 ⑤	
I _N 51 A	
Terminal block width: 7.5 mm / 0.295 inch	
 13 ... 15 mm / 0.51 ... 0.59 inch	

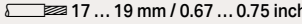
Technical Data	
0.5 ... 10 (16) mm ² ③	20 ... 6 AWG
250 V/4 kV/3 ⑤	
I _N 57 A	
Terminal block width: 10 mm / 0.394 inch	
 17 ... 19 mm / 0.67 ... 0.75 inch	

3

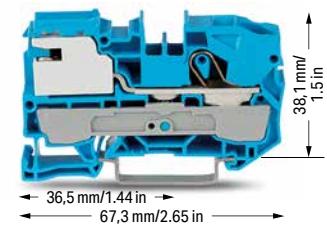
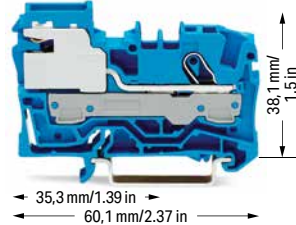
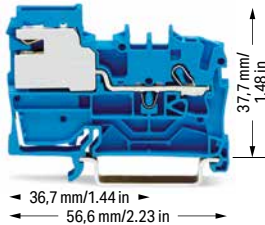

1-conductor N-disconnect terminal block		
Color	Item No.	Pack. Unit
● blue	2002-7114	50

1-conductor N-disconnect terminal block		
Color	Item No.	Pack. Unit
● blue	2006-7114	50

1-conductor N-disconnect terminal block		
Color	Item No.	Pack. Unit
● blue	2010-7114	25

1-conductor power distribution disconnect terminal block		
Color	Item No.	Pack. Unit
○ gray	2002-7111	50

1-conductor power distribution disconnect terminal block		
Color	Item No.	Pack. Unit
○ gray	2006-7111	50

1-conductor power distribution disconnect terminal block		
Color	Item No.	Pack. Unit
○ gray	2010-7111	25

Appropriate through and ground conductor terminal blocks, see page 58

Appropriate through and ground conductor terminal blocks, see page 64

Appropriate through and ground conductor terminal blocks, see page 65

Accessories; item-specific
End and intermediate plate; 0.8 mm thick

	orange	2002-7192	100 (25)
---	--------	-----------	----------

Accessories; item-specific
End and intermediate plate; 1 mm thick

	orange	2006-7192	100 (25)
---	--------	-----------	----------

Accessories; item-specific
End and intermediate plate; 1 mm thick

	orange	2010-7192	100 (25)
---	--------	-----------	----------

Lock-out; prevents reclosing of slide link; snap-on type			
Color	Item No.	Pack. Unit	
	orange	2005-7300	100 (25)

Lock-out; prevents reclosing of slide link; snap-on type			
Color	Item No.	Pack. Unit	
	orange	2006-7300	100 (25)

Lock-out; prevents reclosing of slide link; snap-on type			
Color	Item No.	Pack. Unit	
	orange	2006-7300	100 (25)

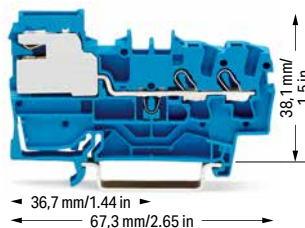

2-conductor N-disconnect terminal block		
Color	Item No.	Pack. Unit
● blue	2002-7214	50

2-conductor power distribution disconnect terminal block		
Color	Item No.	Pack. Unit
○ gray	2002-7211	50

Accessories; item-specific
End and intermediate plate; 0.8 mm thick

	orange	2002-7292	100 (25)
---	--------	-----------	----------

Lock-out; prevents reclosing of slide link; snap-on type			
Color	Item No.	Pack. Unit	
	orange	2005-7300	100 (25)

Accessories; for N-conductor and power distribution disconnect terminal blocks
Appropriate marking systems: WMB/Marking strips

Busbar carrier; not suitable as an end stop; snaps onto DIN-35 rail; 1.5 mm thick			
Color	Item No.	Pack. Unit	
	blue	2009-304	100 (25)

Marking strip; plain; 11 mm wide; 50 m reel			
Color	Item No.	Pack. Unit	
	white	2009-110	1

Busbar carrier; with end stop function and detachable separator plate; snaps onto DIN-35 rail; 7.5 mm thick			
Color	Item No.	Pack. Unit	
	blue	2009-305	25

WMB marking card; white; 10 strips with 10 markers/card; 5 ... 5.2 mm stretchable			
Color	Item No.	Pack. Unit	
	plain	793-5501	5

Busbar; tin-plated; 1000 mm long; copper (10 x 3) mm			
I _N	Item No.	Pack. Unit	
140 A	210-133	1	

Busbar cover; 1000 mm long			
Color	Item No.	Pack. Unit	
transparent	777-303	1	

Connector; for busbar; with blue cover; 2.5 ... 16 mm ²			
Color	Item No.	Pack. Unit	
blue	210-281	100 (50)	

Connector; for busbar; 2.5 ... 35 mm ²			
Color	Item No.	Pack. Unit	
unplated	209-105	1	

Technical Data0.5 ... 16 (25 "f-st") mm² ③ | 20 ... 4 AWG

250 V/4 kV/3 ⑤

I_N 65 A

Terminal block width: 12 mm / 0.472 inch

18 ... 20 mm / 0.71 ... 0.79 inch

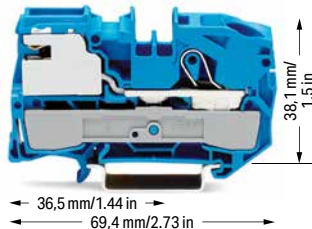
**1-conductor N-disconnect terminal block**

Color	Item No.	Pack. Unit
● blue	2016-7114	25

1-conductor power distribution disconnect terminal block

○ gray	2016-7111	25
--------	-----------	----

Appropriate through and ground conductor terminal blocks, see page 66

Accessories; item-specific**End and intermediate plate; 1 mm thick**

	orange	2016-7192	100 (25)
---	--------	-----------	----------

Lock-out; prevents reclosing of slide link; snap-on type

	orange	2006-7300	100 (25)
---	--------	-----------	----------

① Conductor range: 0.25 ... 4 mm² "s+f-st";
Push-in termination: 1 ... 4 mm² "s" and 1 ... 2.5 mm² "insulated ferrules; 12 mm"
Depending on the conductor characteristic, a conductor with a smaller cross section can also be inserted via push-in termination.

② Conductor range: 0.5 ... 10 mm² "s+f-st";
Push-in termination: 2.5 ... 10 mm² "s" and 2.5 ... 6 mm² "insulated ferrules; 12 mm"
Depending on the conductor characteristic, a conductor with a smaller cross section can also be inserted via push-in termination.

③ Conductor range: 0.5 ... 16 mm² "s+f-st";
Push-in termination: 4 ... 16 mm² "s" and 4 ... 10 mm² "insulated ferrules; 18 mm"
Depending on the conductor characteristic, a conductor with a smaller cross section can also be inserted via push-in termination.

④ Conductor range: 0.5 ... 16 mm² "s+f-st", 25 mm² "f-st";
Push-in termination: 6 ... 16 mm² "s" and 6 ... 16 mm² "insulated ferrules; 18 mm"
Depending on the conductor characteristic, a conductor with a smaller cross section can also be inserted via push-in termination.

⑤ 250 V = rated voltage
4 kV = rated impulse voltage
3 = pollution degree
(see Section 15)

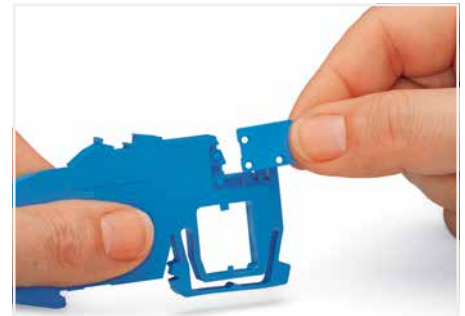
Approvals and corresponding ratings, visit www.wago.com

Inserting the separator plate into the busbar carrier to protect the N-busbar against accidental contact.

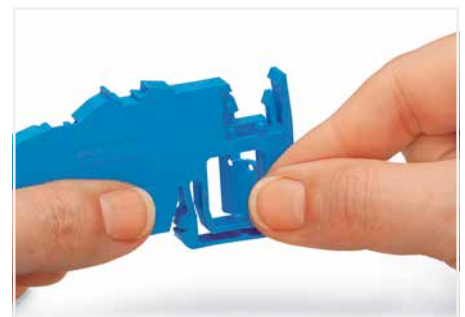

Removing the separator plate from the busbar carrier or from the N-disconnect terminal block.

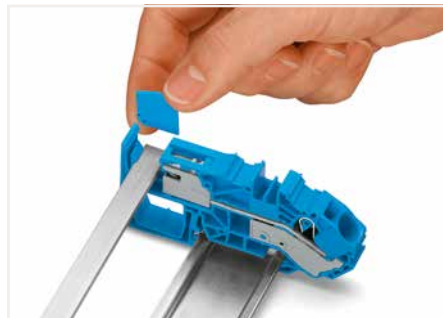

Inserting separator plate removed from N-disconnect terminal block.



Touch-proof N-busbar via inserted separator plate

N-conductor disconnect terminal blocks:

For the construction and operation of power installations in fire-prone, hazardous locations or public buildings – such as conference centers, stores, hospitals, schools, theaters or hotels – the DIN VDE 0100-710 or DIN VDE 0100-718 standards shall be observed. DIN VDE 0100-482 shall also be observed for fire-prone, hazardous locations. These VDE regulations mandate that every neutral conductor must be provided with a disconnection device so, e.g., insulation testing is possible for every circuit without disconnecting the N-conductor. WAGO's N-disconnect terminal blocks meet this requirement.

Power distribution disconnect terminal blocks:

According to DIN VDE 0100-710, "Requirements for operating facilities, rooms and special installations – medical facilities," equipotential bonding conductors shall be run on a potential equalization busbar. The potential equalization busbar and the protective ground conductor busbar must be mounted in a common housing and be connected to each other using a disconnectable copper conductor of minimum 16 mm² (6 AWG). Furthermore, all equipotential bonding conductors must be connected to the potential equalization busbar and clearly arranged so they can be disconnected individually and accessed at any time. Depending on their function, they must be provided with captive marking. WAGO's power distribution disconnect terminal blocks meet these requirements.

PUSH-IN CAGE CLAMP®

Supply Terminal Block for Distribution Boxes, Ground Conductor Terminal Block, N-Disconnect Terminal Block, Power Distribution Disconnect Terminal Block TOPJOB® S

16 (25 "f-st") mm²; 2016 Series

Technical Data

0.5 ... 16 (25 "f-st") mm² ① | 20 ... 4 AWG

800 V/8 kV/3 ②

I_N 76 A

Terminal block width: 12 mm / 0.472 inch

18 ... 20 mm / 0.71 ... 0.79 inch

Technical Data

0.5 ... 16 (25 "f-st") mm² ① | 20 ... 4 AWG

250 V/4 kV/3 ③

I_N 76 A

Terminal block width: 12 mm / 0.472 inch

18 ... 20 mm / 0.71 ... 0.79 inch

① Conductor range: 0.5 ... 16 mm² "s+f-st", 25 mm² "f-st"; Push-in termination: 6 ... 16 mm² "s" and 6 ... 16 mm² "insulated ferrules; 18 mm"
Depending on the conductor characteristic, a conductor with a smaller cross section can also be inserted via push-in termination.

② 800 V = rated voltage
8 kV = rated impulse voltage
3 = pollution degree
(see Section 15)

③ 250 V = rated voltage
4 kV = rated impulse voltage
3 = pollution degree
(see Section 15)

Approvals and corresponding ratings, visit www.wago.com

3

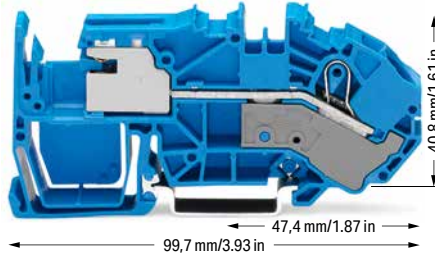
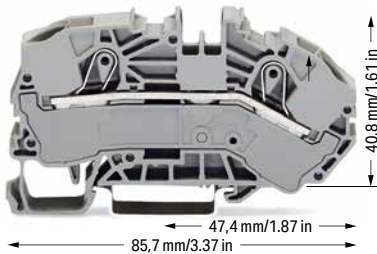

2-conductor supply terminal block for distribution boxes

Color	Item No.	Pack. Unit
gray	2016-7601	20
blue	2016-7604	20

2-conductor ground terminal block

15 mm high DIN-35 rails shall be used for a current load higher than 76 A!

green-yellow	2016-7607	20
--------------	-----------	----

Accessories; item-specific

End and intermediate plate; 1 mm thick

orange	2016-7692	100 (25)
gray	2016-7691	100 (25)

Protective warning marker; with black high-voltage symbol; for 5 terminal blocks

yellow	2016-115	100 (25)
--------	----------	----------

Finger guard; touch-proof cover protects unused conductor entries

yellow	2016-100	100 (25)
--------	----------	----------

1-conductor N-disconnect terminal block

Color	Item No.	Pack. Unit
blue	2016-7714	20

1-conductor power distribution disconnect terminal block

gray	2016-7711	20
------	-----------	----

Accessories; item-specific

End and intermediate plate; 1 mm thick

orange	2016-7792	100 (25)
--------	-----------	----------

Lock-out; prevents reclosing of slide link; snap-on type

orange	2006-7300	100 (25)
--------	-----------	----------

Busbar; tin-plated; 1000 mm long; copper (10 x 3) mm

I _N 140 A	210-133	1
----------------------	---------	---

Busbar cover; 1000 mm long

transparent	777-303	1
-------------	---------	---

N-conductor disconnect terminal blocks:

For the construction and operation of power installations in fire-prone, hazardous locations or public buildings – such as conference centers, stores, hospitals, schools, theaters or hotels – the DIN VDE 0100-710 or DIN VDE 0100-718 standards shall be observed. DIN VDE 0100-482 shall also be observed for fire-prone, hazardous locations. These VDE regulations mandate that every neutral conductor must be provided with a disconnection device so, e.g., insulation testing is possible for every circuit without disconnecting the N-conductor. WAGO's N-disconnect terminal blocks meet this requirement.

Power distribution disconnect terminal blocks:

According to DIN VDE 0100-710, "Requirements for operating facilities, rooms and special installations – medical facilities," equipotential bonding conductors shall be run on a potential equalization busbar. The potential equalization busbar and the protective ground conductor busbar must be mounted in a common housing and be connected to each other using a disconnectable copper conductor of minimum 16 mm² (6 AWG). Furthermore, all equipotential bonding conductors must be connected to the potential equalization busbar and clearly arranged so they can be disconnected individually and accessed at any time. Depending on their function, they must be provided with captive marking. WAGO's power distribution disconnect terminal blocks meet these requirements.

Accessories; 2016 Series

Appropriate marking systems: WMB/Marking strips

Push-in type jumper bar; insulated; I_N 76 A; light gray

2-way	2016-402	25
3-way	2016-403	25
4-way	2016-404	25
5-way	2016-405	25

Push-in type jumper bar; insulated; I_N 76 A; light gray

1 to 3	2016-433	25
1 to 4	2016-434	25
1 to 5	2016-435	25

Test plug adapter; for 4 mm Ø test plug

gray	2009-174	100 (25)
------	----------	----------

Testing tap; for max. 2.5 mm²

gray	2009-182	100 (25)
------	----------	----------

Marking strip; plain; 11 mm wide; 50 m reel

white	2009-110	1
-------	----------	---

WMB marking card; white; 10 strips with 10 markers/card; 5 ... 5.2 mm stretchable

plain	793-5501	5
-------	----------	---

Supply Terminal Blocks Assembly TOPJOB® S

3

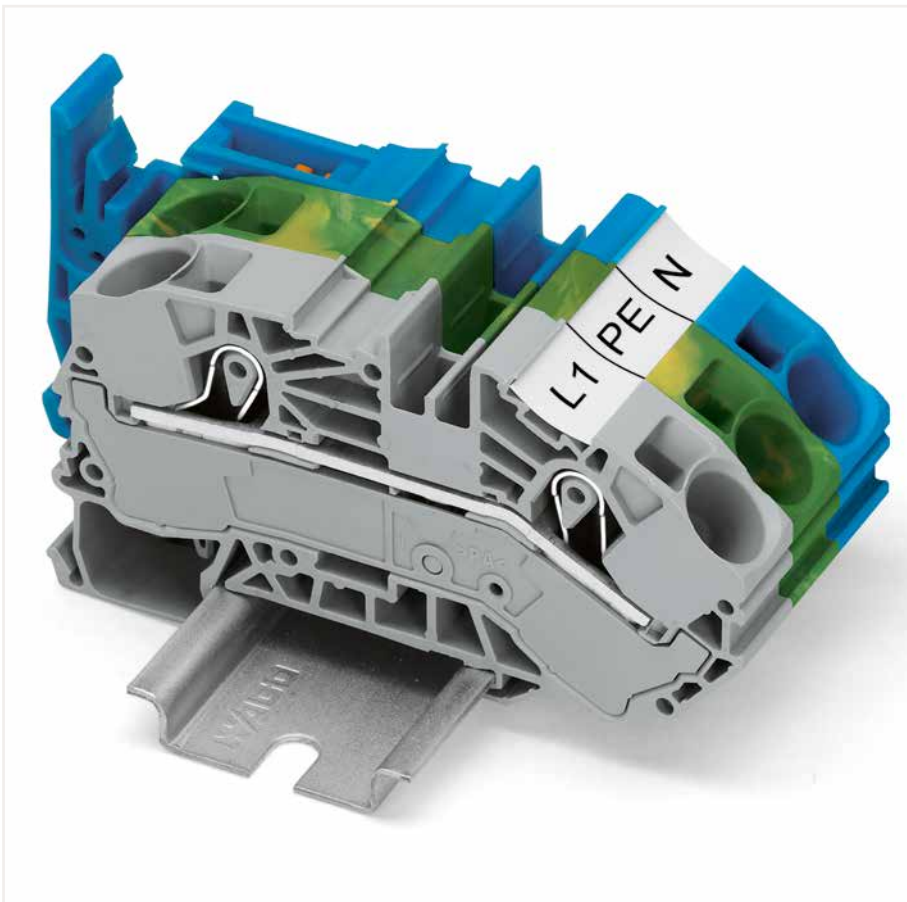

With an angled conductor entry, the 2016 Series Supply Terminal Blocks simplify the wiring of solid conductors in distribution boxes. Solid conductors of the largest cross-section can be connected easily, enabling the distribution box cover to fit without interfering with the conductors.

Board Set 821 Series

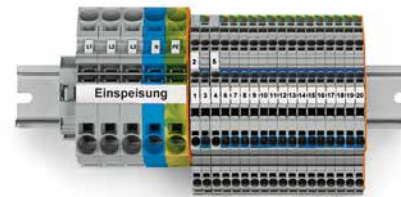
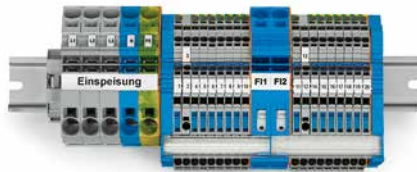
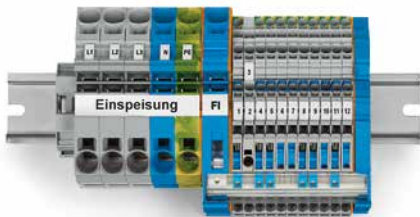

Subdistribution board set TOPJOB® S

Item No.	Pack. Unit
821-104	1

Contains:

- 10 x Multilevel installation terminal block; NT/L/PE; 4 mm² (2003-7641)
- 1 x Multilevel installation terminal block; L/L; 4 mm² (2003-7642)
- 1 x End and intermediate plate (2003-7692)
- 3 x 2-conductor supply terminal block for distribution boxes; gray; 16 mm² (2016-7601)
- 1 x 2-conductor supply terminal block for distribution boxes; blue; 16 mm² (2016-7604)
- 1 x 2-conductor ground terminal block; green-yellow; 16 mm² (2016-7607)
- 1 x End and intermediate plate (2016-7692)
- 1 x 1-conductor N-disconnect terminal block; blue; 16 mm² (2016-7714)
- 1 x End and intermediate plate (2016-7792)
- 1 x Screwless end stop; 10 mm wide (249-117)
- 1 x Busbar carrier; with end stop function (2009-305)
- 1 x Busbar; tin-plated; 0.2 m (210-133)
- 1 x N-busbar cover; transparent; 0.2 m (777-303)
- 1 x Marking strips; white; 0.5 m (2009-110)
- 1 x WMB marking card; 1 ... 50 (793-5566)
- 1 x WMB marking card; L1, L2, L3, N, PE (793-5472)
- 1 x Fiber-tip pen (210-110)

FI main distribution board set TOPJOB® S

Item No.	Pack. Unit
821-122	1

Contains:

- 16 x Multilevel installation terminal block; NT/L/PE; 4 mm² (2003-7641)
- 2 x Multilevel installation terminal block; L/L; 4 mm² (2003-7642)
- 2 x End and intermediate plate (2003-7692)
- 3 x 2-conductor supply terminal block for distribution boxes; gray; 16 mm² (2016-7601)
- 1 x 2-conductor supply terminal block for distribution boxes; blue; 16 mm² (2016-7604)
- 1 x 2-conductor ground terminal block; green-yellow; 16 mm² (2016-7607)
- 1 x End and intermediate plate (2016-7692)
- 2 x 1-conductor N-disconnect terminal block; blue; 16 mm² (2016-7714)
- 1 x End and intermediate plate (2016-7792)
- 1 x Screwless end stop; 10 mm wide (249-117)
- 2 x Busbar carrier; with end stop function (2009-305)
- 1 x Busbar; tin-plated; 0.2 m (210-133)
- 1 x N-busbar cover; transparent; 0.2 m (777-303)
- 1 x Marking strips; white; 0.5 m (2009-110)
- 1 x WMB marking card; 1 ... 50 (793-5566)
- 1 x WMB marking card; L1, L2, L3, N, PE (793-5472)
- 1 x Fiber-tip pen (210-110)

FI/LS main distribution board set TOPJOB® S

Item No.	Pack. Unit
821-123	1

Contains:

- 16 x Multilevel installation terminal block; NT/L/PE; 4 mm² (2003-7641)
- 2 x Multilevel installation terminal block; L/L; 4 mm² (2003-7642)
- 1 x End and intermediate plate (2003-7692)
- 3 x 2-conductor supply terminal block for distribution boxes; gray; 16 mm² (2016-7601)
- 1 x 2-conductor supply terminal block for distribution boxes; blue; 16 mm² (2016-7604)
- 1 x 2-conductor ground terminal block; green-yellow; 16 mm² (2016-7607)
- 1 x End and intermediate plate (2016-7692)
- 2 x Screwless end stop; 10 mm wide (249-117)
- 1 x Marking strips; white; 0.5 m (2009-110)
- 1 x WMB marking card; 1 ... 50 (793-5566)
- 1 x WMB marking card; L1, L2, L3, N, PE (793-5472)
- 1 x Fiber-tip pen (210-110)



Set TOPJOB® S

Item No.	Pack. Unit
821-129	1

Contains:

- 16 x Multilevel installation terminal block; NT/L/PE; 4 mm² (2003-6641)
- 2 x Multilevel installation terminal block; L/L; 4 mm² (2003-6642)
- 1 x End and intermediate plate (2003-6692)
- 3 x 2-conductor supply terminal block for distribution boxes; gray; 16 mm² (2016-7601)
- 1 x 2-conductor supply terminal block for distribution boxes; blue; 16 mm² (2016-7604)
- 1 x 2-conductor ground terminal block; green-yellow; 16 mm² (2016-7607)
- 1 x End and intermediate plate (2016-7692)
- 2 x Screwless end stop; 10 mm wide (249-117)
- 15 x Push-in type jumper bar; 2-way (2002-402)
- 2 x Test plug adapter N/L; gray (2003-499)
- 2 x Test plug adapter N; gray (2003-500)
- 2 x Test plug adapter; for 4 mm Ø test plugs (2009-174)
- 1 x Marking strips; white; 0.5 m (2009-110)
- 1 x WMB marking card; 1 ... 50 (793-5566)
- 1 x WMB marking card; L1, L2, L3, N, PE (793-5472)
- 1 x Fiber-tip pen (210-110)

INSTA-BOX TOPJOB® S

Item No.	Pack. Unit
821-120	1

Contains:



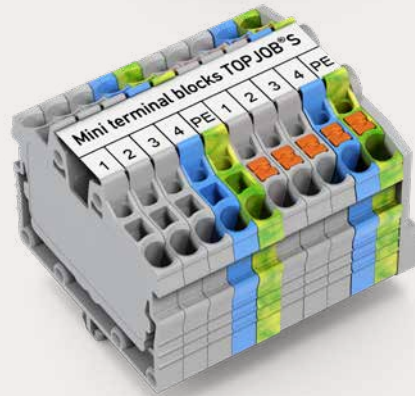
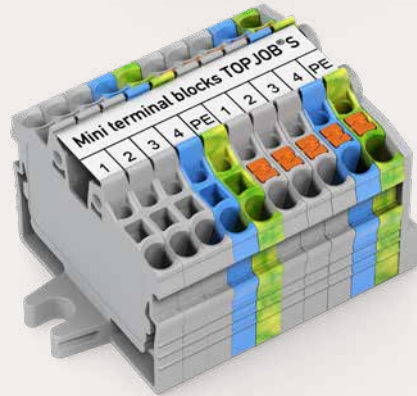
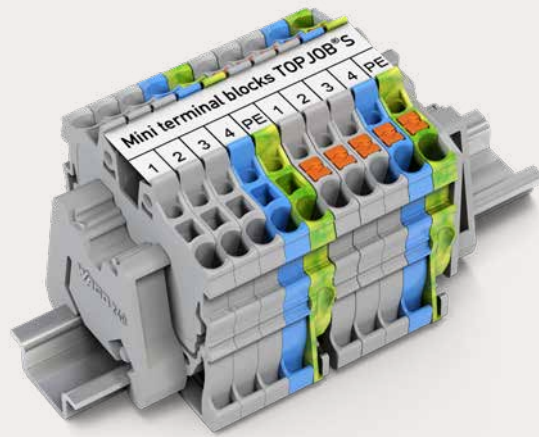

- 50 x Multilevel installation terminal block; NT/L/PE; 4 mm² (2003-7641)
- 10 x Multilevel installation terminal block; L/L; 4 mm² (2003-7642)
- 10 x End and intermediate plate (2003-7692)
- 9 x 2-conductor supply terminal block for distribution boxes; gray; 16 mm² (2016-7601)
- 3 x 2-conductor supply terminal block for distribution boxes; blue; 16 mm² (2016-7604)
- 3 x 2-conductor ground terminal block; green-yellow; 16 mm² (2016-7607)
- 10 x End and intermediate plate (2016-7692)
- 6 x 1-conductor N-disconnect terminal block; blue; 16 mm² (2016-7714)
- 5 x End and intermediate plate (2016-7792)
- 5 x Screwless end stop; 10 mm wide (249-117)
- 6 x Busbar carrier; with end stop function (2009-305)
- 5 x Busbar carrier; not suitable for use as end stop (2009-304)
- 1 x Busbar; tin-plated; 0.25 m (210-133)
- 1 x N-busbar cover; transparent; 0.25 m (777-303)
- 10 x Staggered jumper; 3-way (2002-473)
- 10 x Staggered jumper; 5-way (2002-475)
- 10 x Staggered jumper; 7-way (2002-477)
- 10 x Push-in type jumper bar; 2-way (2002-402)
- 5 x Push-in type jumper bar; 2-way (2016-402)
- 2 x Test plug; 2 mm Ø; Ø 2 mm (210-136)
- 2 x Testing tap; for max. 2.5 mm² (2009-182)
- 5 x Lock-out; prevents reclosing of slide link; for 2002 and 2005 Series (2005-7300)
- 5 x Lock-out; prevents reclosing of slide link; for 2006 and 2016 Series (2006-7300)
- 4 x Marking strips; white; 0.5 m (2009-110)
- 2 x WMB marking card; 1 ... 50 (793-5566)
- 1 x WMB marking card; L1, L2, L3, N, PE (793-5472)
- 2 x WMB marking card; unbedruckt (793-5501)
- 1 x Fiber-tip pen (210-110)
- 1 x Operating tool (2009-310)
- 1 x Sortimo®-T-BOXX



WAGO Mini Rail-Mount Terminal Blocks TOPJOB[®] S

WAGO Mini Rail-Mount Terminal Blocks TOPJOB® S

Front-Entry Wiring

			Page
	Miniature Through and Ground Conductor Terminal Blocks; with Push-Buttons; for DIN-15 Rail 1 (1.5) mm ² (16 AWG)	2250 Series	248
	Miniature Through and Ground Conductor Terminal Blocks; for DIN-15 Rail 1 (1.5) mm ² (16 AWG)	2050 Series	249
	Miniature Through Terminal Blocks; with Push-Buttons; for DIN-15 Rail 1 (1.5) mm ² (16 AWG)	2250 Series	250
	Miniature Through Terminal Blocks; for DIN-15 Rail 1 (1.5) mm ² (16 AWG)	2050 Series	252

Miniature Rail-Mount Terminal Blocks TOPJOB® S; with/without push-buttons and with Push-in CAGE CLAMP® 2250 and 2050 Series Description and Installation



Insert ferruled conductors via push-in termination.



Insert fine-stranded conductors via operating tool.



Remove all conductors via operating tool.

4



Insert a jumper (star point jumper) and push down until it hits the backstop.



Insert a jumper (delta jumper) and push down until it hits the backstop.



Marking strip (2009-110) inserted in the marking slot with jumper symbols of the inserted jumper



Snapping a marking strip (2009-110) into a marker slot.



Snapping a WMB marking strip into a marker slot.



Push-in CAGE CLAMP® terminates the following copper conductors:
solid "s"



stranded "st"



fine-stranded "f-st", also with tinned single strands

PUSH-IN CAGE CLAMP®



Insert ferruled conductors via push-in termination.



Insert fine-stranded conductors via operating tool.



Remove all conductors via operating tool.



Mounting a terminal strip with snap-in feet into holes.



Terminal strip; with snap-in mounting feet
Snapping a mounting foot (209-120)
(Distance between mounting feet: approx. 20 ... 25 mm)



Terminal strip; with snap-in mounting feet; for DIN-35 rail
(209-120 Mounting Foot)



Mounting and securing a terminal strip directly to the plate via screw-type flanges



Terminal strip; with mounting flanges; screw mounting



Testing with a 2 mm Ø 210-136 Test Plug (max. 42 V).



fine-stranded,
tip-bonded



fine-stranded,
with ferrule
(gastight crimped)



fine-stranded,
with pin terminal
(gastight crimped)

PUSH-IN CAGE CLAMP®

Miniature Through Terminal Block and Ground Conductor Terminal Block TOPJOB® S; with Push-Button; for DIN-15 Rail 1 (1.5) mm²; 2250 Series

Technical Data

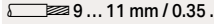
0.14 ... 1 (1.5) mm ² ①	24 ... 16 AWG
500 V/6 kV/3 ②	300 V, 10 A ③
I _N 13.5 A (17.5 A)	300 V, 10 A ④
Terminal block width: 3.5 mm / 0.138 inch	
 9 ... 11 mm / 0.35 ... 0.43 inch	

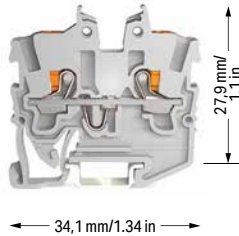

2-conductor miniature through terminal block; with push-button; for DIN-15 rail

Color	Item No.	Pack. Unit
gray ⑤	2250-1201 ④	100
blue ⑤	2250-1204 ③ ④	100

2-conductor miniature ground terminal block; with push-button; for DIN-15 rail

green-yellow ⑤	2250-1207 ④	100
----------------	-------------	-----

Accessories; 2250 Series

Appropriate marking systems:
WMB/WMB Inline/Marking strips

End and intermediate plate; 1.1 mm thick

gray	2050-1291	100 (25)
------	-----------	----------

Push-in type jumper bar; insulated; I_N 14 A; light gray

	2-way	2000-402	25
	3-way	2000-403	25
	4-way	2000-404	25
	5-way	2000-405	25
	6-way	2000-406	25
	7-way	2000-407	25
	8-way	2000-408	25
	9-way	2000-409	25
	10-way	2000-410	25

Push-in type jumper bar; insulated; I_N 14 A; light gray

	1 to 3	2000-433	25
	1 to 4	2000-434	25
	1 to 5	2000-435	25
	1 to 6	2000-436	25
	1 to 7	2000-437	25
	1 to 8	2000-438	25
	1 to 9	2000-439	25
	1 to 10	2000-440	25

Delta jumper; insulated; I_N = I_N terminal block; light gray

	1-2-3-4-5-6	2000-406/020-000	25
---	-------------	------------------	----

Star point jumper; insulated; I_N = I_N terminal block; light gray

	1-3-5	2000-405/011-000	25
---	-------	------------------	----

Push-in type wire jumper; insulated; 0.75 mm² conductor cross-section; I_N 9 A

	L = 60 mm	2009-402	100 (10)
	L = 110 mm	2009-404	100 (10)
	L = 250 mm	2009-406	100 (10)

① Conductor range: 0.14 ... 1.5 mm² "s+f-st"; Push-in termination: 0.5 ... 1.5 mm² "s" and 0.5 ... 0.75 mm² "insulated ferrules; 10 mm" Depending on the conductor characteristic, a conductor with a smaller cross section can also be inserted via push-in termination.

② 500 V = rated voltage
6 kV = rated impulse voltage
3 = pollution degree (see Section 15)

③ Terminal blocks with a blue insulated housing are suitable for Ex i applications.

④ Terminal blocks with an Ex mark are suitable for Ex e II applications.
352 V; 13.5 A
12 A jumper (see Section 15)

Please observe the application notes:
Jumpers, from page 174
Testing accessories, from page 168
Marking, from page 640

Approvals and corresponding ratings, visit www.wago.com

Accessories; 2250 Series

Appropriate marking systems:
WMB/WMB Inline/Marking strips

Modular connector; snaps together; for jumper contact slot
Terminal block width: 5 mm / 0.197 inch
Only for test purposes

gray	2000-511	100 (25)
------	----------	----------

Modular connector; snaps together; for jumper contact slot
Only for test purposes

gray	2000-510	100 (25)
------	----------	----------

Spacer module; snaps together; bridges commoned terminal blocks

gray	2000-549	100 (25)
------	----------	----------

Test plug; with 500 mm cable; 2 mm Ø; max. 42 V

red	210-136	50
-----	---------	----

Marking strip; plain; 11 mm wide; 50 m reel

white	2009-110	1
-------	----------	---

WMB Inline; plain; 2,300 WMB markers (3.5 mm)/reel

white	2009-113	1
-------	----------	---

WMB Marker Card; white; 10 strips with 10 markers/card; for 3.5 mm terminal block width

plain	793-3501	5
-------	----------	---

Accessories; 2250 Series

Appropriate marking systems:
WMB/WMB Inline/Marking strips

Screwless end stop; for DIN-15 rail; 6 mm wide

gray	249-101	25
------	---------	----

Steel DIN-rail; per EN 60715; 15 x 5.5 mm; 1 mm thick; 2 m long

slotted	210-111	10 (1)
unslotted	210-295	10 (1)

Aluminum DIN-rail; similar to EN 60715; 15 x 5.5 mm; 1 mm thick; 2 m long

unslotted	210-296	1
-----------	---------	---

Miniature Through Terminal Block and Ground Conductor Terminal Block TOPJOB® S; for DIN-15 Rail

1 (1.5) mm²; 2050 Series

Technical Data

0.14 ... 1 (1.5) mm ² ①	24 ... 16 AWG
500 V/6 kV/3 ②	300 V, 10 A ③
I _N 13.5 A (17.5 A)	300 V, 10 A ④
Terminal block width: 3.5 mm / 0.138 inch	
9 ... 11 mm / 0.35 ... 0.43 inch	

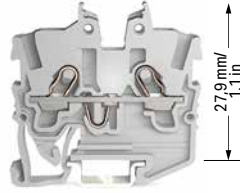

2-conductor miniature through terminal block; for DIN-15 rail

Color	Item No.	Pack. Unit
gray ⑤	2050-1201 ④	100
blue ⑥	2050-1204 ③ ④	100

2-conductor miniature ground terminal block; for DIN-15 rail

green-yellow ⑦	2050-1207 ④	100
----------------	-------------	-----

Accessories; 2050 Series

Appropriate marking systems:
WMB/WMB Inline/Marking strips

End and intermediate plate; 1.1 mm thick

gray	2050-1291	100 (25)
------	-----------	----------

Push-in type jumper bar; insulated; I_N 14 A; light gray

2-way	2000-402	25
3-way	2000-403	25
4-way	2000-404	25
5-way	2000-405	25
6-way	2000-406	25
7-way	2000-407	25
8-way	2000-408	25
9-way	2000-409	25
10-way	2000-410	25

Push-in type jumper bar; insulated; I_N 14 A; light gray

1 to 3	2000-433	25
1 to 4	2000-434	25
1 to 5	2000-435	25
1 to 6	2000-436	25
1 to 7	2000-437	25
1 to 8	2000-438	25
1 to 9	2000-439	25
1 to 10	2000-440	25

Delta jumper; insulated; I_N = I_N terminal block; light gray

1-2-3-4-5-6	2000-406/020-000	25
-------------	------------------	----

Star point jumper; insulated; I_N = I_N terminal block; light gray

1-3-5	2000-405/011-000	25
-------	------------------	----

Protective warning marker; with black high-voltage symbol; for 5 terminal blocks

yellow	2000-115	100 (25)
--------	----------	----------

① Conductor range: 0.14 ... 1.5 mm² "s+f-st";
Push-in termination: 0.5 ... 1.5 mm² "s" and
0.5 ... 0.75 mm² "insulated ferrules; 10 mm"
Depending on the conductor characteristic, a conductor
with a smaller cross section can also be inserted
via push-in termination.

② 500 V = rated voltage
6 kV = rated impulse voltage
3 = pollution degree
(see Section 15)

③ Terminal blocks with a blue insulated housing are
suitable for Ex i applications.

④ Terminal blocks with an Ex mark are suitable for Ex e II
applications.
352 V; 13.5 A
12 A jumper
(see Section 15)

Please observe the application notes:
Jumpers, from page 174
Testing accessories, from page 168
Marking, from page 640

Approvals and corresponding ratings,
visit www.wago.com

Accessories; 2050 Series

Appropriate marking systems:
WMB/WMB Inline/Marking strips

Push-in type wire jumper; insulated; 0.75 mm² conductor cross-section; I_N 9 A

L = 60 mm	2009-402	100 (10)
L = 110 mm	2009-404	100 (10)
L = 250 mm	2009-406	100 (10)

Modular connector; snaps together; for jumper contact slot

Terminal block width: 5 mm / 0.197 inch Only for test purposes	gray	2000-511	100 (25)
---	------	----------	----------

Modular connector; snaps together; for jumper contact slot

Only for test purposes	gray	2000-510	100 (25)
------------------------	------	----------	----------

Spacer module; snaps together; bridges commoned terminal blocks

gray	2000-549	100 (25)
------	----------	----------

Test plug; with 500 mm cable; 2 mm Ø; max. 42 V

red	210-136	50
-----	---------	----

Marking strip; plain; 11 mm wide; 50 m reel

white	2009-110	1
-------	----------	---

WMB Inline; plain; 2,300 WMB markers (3.5 mm)/reel

white	2009-113	1
-------	----------	---

WMB Marker Card; white; 10 strips with 10 markers/card; for 3.5 mm terminal block width

plain	793-3501	5
-------	----------	---

Accessories; 2050 Series

Appropriate marking systems:
WMB/WMB Inline/Marking strips

Screwless end stop; for DIN-15 rail; 6 mm wide

gray	249-101	25
------	---------	----

Steel DIN-rail; per EN 60715; 15 x 5.5 mm; 1 mm thick; 2 m long

slotted	210-111	10 (1)
unslotted	210-295	10 (1)

Aluminum DIN-rail; similar to EN 60715; 15 x 5.5 mm; 1 mm thick; 2 m long

unslotted	210-296	1
-----------	---------	---

Miniature Through Terminal Block TOPJOB® S; with Push-Button; with Mounting Flange 1 (1.5) mm²; 2250 Series

Technical Data

0.14 ... 1 (1.5) mm² ①	24 ... 16 AWG
500 V/6 kV/3 ②	300 V, 10 A ③
I _N 13.5 A (17.5 A)	300 V, 10 A ④
Terminal block width: 3.5 mm / 0.138 inch	
9 ... 11 mm / 0.35 ... 0.43 inch	



Dimensions (in mm):

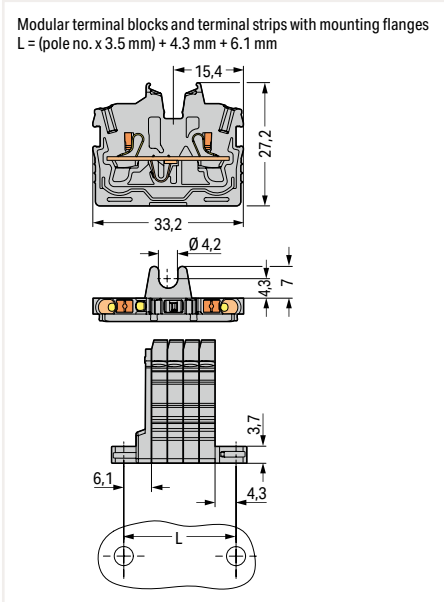

2-conductor miniature through terminal block; with push-button; end terminal block with mounting flange; for screw or similar mounting types; 4.2 mm mounting hole diameter; with mounting foot (209-123) also for DIN-35 rail

Color	Item No.	Pack. Unit
gray ⑤	2250-301 ④	100
blue ⑤	2250-304 ③ ④	100
green-yellow ⑤	2250-307 ④	100

2-conductor miniature through terminal block; with push-button; center terminal block; without snap-in mounting foot; without mounting flange; for 0.6 ... 1.2 mm plate thickness; required between end plate and end terminal block for terminal strips with mounting flanges

Color	Item No.	Pack. Unit
gray ⑤	2250-321 ④	100
blue ⑤	2250-324 ③ ④	100
green-yellow ⑤	2250-327 ④	100

Accessories; 2250 Series

Appropriate marking systems:
WMB/WMB Inline/Marking strips

End plate; with mounting flange; 1.3 mm thick		
gray	2050-381	100 (25)

- Conductor range: 0.14 ... 1.5 mm² "s+f-st"; Push-in termination: 0.5 ... 1.5 mm² "s" and 0.5 ... 0.75 mm² "insulated ferrules; 10 mm" Depending on the conductor characteristic, a conductor with a smaller cross section can also be inserted via push-in termination.
- 500 V = rated voltage
6 kV = rated impulse voltage
3 = pollution degree (see Section 15)
- Terminal blocks with a blue insulated housing are suitable for Ex i applications.
- Terminal blocks with an Ex mark are suitable for Ex e II applications.
352 V; 13.5 A
12 A jumper (see Section 15)

Please observe the application notes:
Jumpers, from page 174
Testing accessories, from page 168
Marking, from page 640

Approvals and corresponding ratings, visit www.wago.com

Accessories; 2250 Series

Appropriate marking systems:
WMB/WMB Inline/Marking strips

Push-in type jumper bar; insulated; I _N 14 A; light gray		
2-way	2000-402	25
3-way	2000-403	25
4-way	2000-404	25
5-way	2000-405	25
6-way	2000-406	25
7-way	2000-407	25
8-way	2000-408	25
9-way	2000-409	25
10-way	2000-410	25

Push-in type jumper bar; insulated; I _N 14 A; light gray		
1 to 3	2000-433	25
1 to 4	2000-434	25
1 to 5	2000-435	25
1 to 6	2000-436	25
1 to 7	2000-437	25
1 to 8	2000-438	25
1 to 9	2000-439	25
1 to 10	2000-440	25

Delta jumper; insulated; I _N = I _N terminal block; light gray		
1-2 3-4 5-6	2000-406/020-000	25

Star point jumper; insulated; I _N = I _N terminal block; light gray		
1-3-5	2000-405/011-000	25

Push-in type wire jumper; insulated; 0.75 mm² conductor cross-section; I _N 9 A		
L = 60 mm	2009-402	100 (10)
L = 110 mm	2009-404	100 (10)
L = 250 mm	2009-406	100 (10)

Modular connector; snaps together; for jumper contact slot		
Terminal block width: 5 mm / 0.197 inch		
Only for test purposes		
gray	2000-511	100 (25)

Accessories; 2250 Series

Appropriate marking systems:
WMB/WMB Inline/Marking strips

Modular connector; snaps together; for jumper contact slot		
Only for test purposes		
gray	2000-510	100 (25)

Spacer module; snaps together; bridges commoned terminal blocks		
gray	2000-549	100 (25)

Test plug; with 500 mm cable; 2 mm Ø; max. 42 V		
red	210-136	50

Mounting foot with screw; for DIN-35 rail; can be screwed on terminal blocks with mounting flange; 6.4 mm wide		
gray	209-123	25

Mounting adapter; for DIN-35 rail; can be used as end plate; 6.5 mm wide		
gray	209-137	25

Miniature Through Terminal Block TOPJOB® S; with Push-Button; with Snap-In Mounting Foot 1 (1.5) mm²; 2250 Series

Technical Data

0.14 ... 1 (1.5) mm ² ①	24 ... 16 AWG
500 V/6 kV/3 ②	300 V, 10 A ④
I _N 13.5 A (17.5 A)	300 V, 10 A ④
Terminal block width: 3.5 mm / 0.138 inch	
9 ... 11 mm / 0.35 ... 0.43 inch	



Dimensions (in mm):

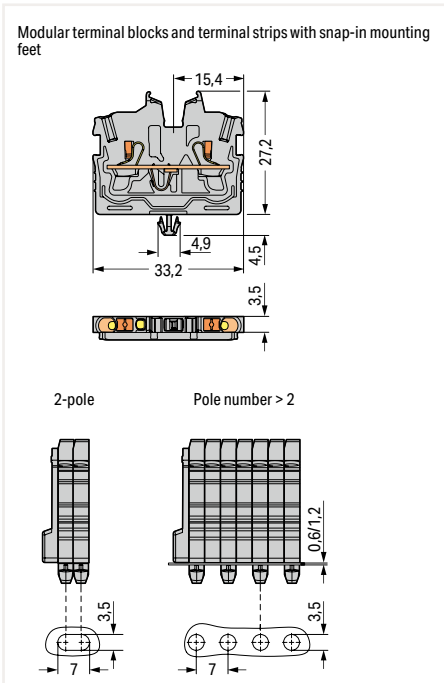

2-conductor miniature through terminal block; with push-button; with snap-in mounting foot; for 0.6 ... 1.2 mm plate thickness; 3.5 mm mounting hole diameter; also for aluminum DIN-rail (210-154) or with mounting foot (209-120) for DIN-35 rail

Color	Item No.	Pack. Unit
gray ④	2250-311 ④	100
blue ④	2250-314 ③ ④	100
green-yellow ④	2250-317 ④	100

2-conductor miniature through terminal block; with push-button; center terminal block; without snap-in mounting foot; without mounting flange; for 0.6 ... 1.2 mm plate thickness; required between end plate and end terminal block for terminal strips with mounting flanges

Color	Item No.	Pack. Unit
gray ④	2250-321 ④	100
blue ④	2250-324 ③ ④	100
green-yellow ④	2250-327 ④	100

① Conductor range: 0.14 ... 1.5 mm² "s+f-st"; Push-in termination: 0.5 ... 1.5 mm² "s" and 0.5 ... 0.75 mm² "insulated ferrules; 10 mm" Depending on the conductor characteristic, a conductor with a smaller cross section can also be inserted via push-in termination.

② 500 V = rated voltage
6 kV = rated impulse voltage
3 = pollution degree
(see Section 15)

③ Terminal blocks with a blue insulated housing are suitable for Ex i applications.

④ Terminal blocks with an Ex mark are suitable for Ex e II applications.
352 V; 13.5 A
12 A jumper
(see Section 15)

Please observe the application notes:
Jumpers, from page 174
Testing accessories, from page 168
Marking, from page 640

Approvals and corresponding ratings, visit www.wago.com

Accessories; 2250 Series

Appropriate marking systems:
WMB/WMB Inline/Marking strips

End plate; for terminal blocks with snap-in mounting foot; 3.4 mm thick

gray	2050-391	100 (25)
------	----------	----------

Push-in type jumper bar; insulated; I_N 14 A; light gray

2-way	2000-402	25
3-way	2000-403	25
4-way	2000-404	25
5-way	2000-405	25
6-way	2000-406	25
7-way	2000-407	25
8-way	2000-408	25
9-way	2000-409	25
10-way	2000-410	25

Push-in type jumper bar; insulated; I_N 14 A; light gray

1 to 3	2000-433	25
1 to 4	2000-434	25
1 to 5	2000-435	25
1 to 6	2000-436	25
1 to 7	2000-437	25
1 to 8	2000-438	25
1 to 9	2000-439	25
1 to 10	2000-440	25

Delta jumper; insulated; I_N = I_N terminal block; light gray

1-2 3-4 5-6	2000-406/020-000	25
-------------	------------------	----

Star point jumper; insulated; I_N = I_N terminal block; light gray

1-3-5	2000-405/011-000	25
-------	------------------	----

Push-in type wire jumper; insulated; 0.75 mm² conductor cross-section; I_N 9 A

L = 60 mm	2009-402	100 (10)
L = 110 mm	2009-404	100 (10)
L = 250 mm	2009-406	100 (10)

Accessories; 2250 Series

Appropriate marking systems:
WMB/WMB Inline/Marking strips

Modular connector; snaps together; for jumper contact slot
Terminal block width: 5 mm / 0.197 inch
Only for test purposes

gray	2000-511	100 (25)
------	----------	----------

Modular connector; snaps together; for jumper contact slot
Only for test purposes

gray	2000-510	100 (25)
------	----------	----------

Spacer module; snaps together; bridges commoned terminal blocks

gray	2000-549	100 (25)
------	----------	----------

Test plug; with 500 mm cable; 2 mm Ø; max. 42 V

red	210-136	50
-----	---------	----

Aluminum DIN-rail; 1000 mm long; 18 mm wide; 7 mm high

	210-154	1
--	---------	---

Plastic end stop; with WSB marker slot; for aluminum DIN-rail (210-154); 6 mm wide

	209-122	25
--	---------	----

Mounting foot; for DIN-35 rail; snaps onto terminal blocks with snap-in mounting foot; 6.4 mm wide

gray	209-120	25
------	---------	----

Mounting screw; for mounting foot (209-120)

	209-119	500 (50)
--	---------	----------

Mounting adapter; for DIN-35 rail; can be used as end plate; 6.5 mm wide

gray	209-137	25
------	---------	----

Miniature Through Terminal Block TOPJOB® S; with Mounting Flange 1 (1.5) mm²; 2050 Series

Technical Data

0.14 ... 1 (1.5) mm² ①	24 ... 16 AWG
500 V/6 kV/3 ②	300 V, 10 A ③
I _N 13.5 A (17.5 A)	300 V, 10 A ④
Terminal block width: 3.5 mm / 0.138 inch	
9 ... 11 mm / 0.35 ... 0.43 inch	



Dimensions (in mm):

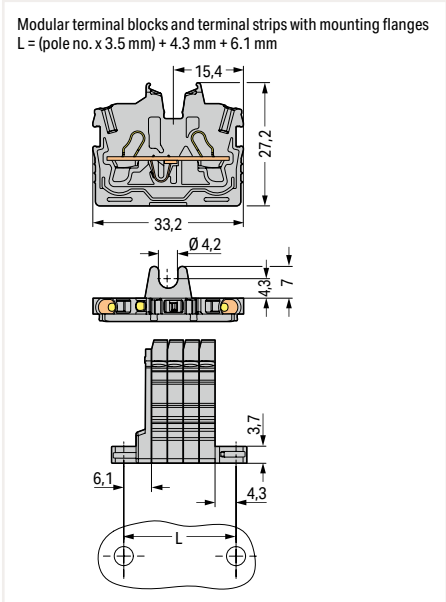

2-conductor miniature through terminal block; with mounting flange; for screw or similar mounting types; 4.2 mm mounting hole diameter; with mounting foot (209-123) also for DIN-35 rail

Color	Item No.	Pack. Unit
gray ☺	2050-301 ④	100
blue ☺	2050-304 ③ ④	100
green-yellow ☺	2050-307 ④	100

2-conductor miniature through terminal block; center terminal block; without snap-in mounting foot; without mounting flange; for 0.6 ... 1.2 mm plate thickness; required between end plate and end terminal block for terminal strips with mounting flanges

gray ☺	2050-321 ④	100
blue ☺	2050-324 ③ ④	100
green-yellow ☺	2050-327 ④	100

Accessories; 2050 Series

Appropriate marking systems:
WMB/WMB Inline/Marking strips

End plate; with mounting flange; 1.3 mm thick

gray	2050-381	100 (25)
------	----------	----------



- Conductor range: 0.14 ... 1.5 mm² "s+f-st"; Push-in termination: 0.5 ... 1.5 mm² "s" and 0.5 ... 0.75 mm² "insulated ferrules; 10 mm" Depending on the conductor characteristic, a conductor with a smaller cross section can also be inserted via push-in termination.
- 500 V = rated voltage
6 kV = rated impulse voltage
3 = pollution degree (see Section 15)
- Terminal blocks with a blue insulated housing are suitable for Ex i applications.
- Terminal blocks with an Ex mark are suitable for Ex e II applications.
352 V; 13.5 A
12 A jumper (see Section 15)

Please observe the application notes:
Jumpers, from page 174
Testing accessories, from page 168
Marking, from page 640

Approvals and corresponding ratings, visit www.wago.com

Accessories; 2050 Series

Appropriate marking systems:
WMB/WMB Inline/Marking strips

Push-in type jumper bar; insulated; I_N 14 A; light gray

	2-way	2000-402	25
	3-way	2000-403	25
	4-way	2000-404	25
	5-way	2000-405	25
	6-way	2000-406	25
	7-way	2000-407	25
	8-way	2000-408	25
	9-way	2000-409	25
	10-way	2000-410	25

Push-in type jumper bar; insulated; I_N 14 A; light gray

	1 to 3	2000-433	25
	1 to 4	2000-434	25
	1 to 5	2000-435	25
	1 to 6	2000-436	25
	1 to 7	2000-437	25
	1 to 8	2000-438	25
	1 to 9	2000-439	25
	1 to 10	2000-440	25

Delta jumper; insulated; I_N = I_N terminal block; light gray

	1-2 3-4 5-6	2000-406/020-000	25
--	-------------	------------------	----

Star point jumper; insulated; I_N = I_N terminal block; light gray

	1-3-5	2000-405/011-000	25
--	-------	------------------	----

Push-in type wire jumper; insulated; 0.75 mm² conductor cross-section; I_N 9 A

	L = 60 mm	2009-402	100 (10)
	L = 110 mm	2009-404	100 (10)
	L = 250 mm	2009-406	100 (10)

Protective warning marker; with black high-voltage symbol; for 5 terminal blocks

	yellow	2000-115	100 (25)
--	--------	----------	----------

Modular connector; snaps together; for jumper contact slot
Terminal block width: 5 mm / 0.197 inch
Only for test purposes

	gray	2000-511	100 (25)
--	------	----------	----------

Accessories; 2050 Series

Appropriate marking systems:
WMB/WMB Inline/Marking strips

Modular connector; snaps together; for jumper contact slot
Only for test purposes

	gray	2000-510	100 (25)
--	------	----------	----------

Spacer module; snaps together; bridges commoned terminal blocks

	gray	2000-549	100 (25)
--	------	----------	----------

Test plug; with 500 mm cable; 2 mm Ø; max. 42 V

	red	210-136	50
--	-----	---------	----

Mounting foot with screw; for DIN-35 rail; can be screwed on terminal blocks with mounting flange; 6.4 mm wide

	gray	209-123	25
--	------	---------	----

Mounting adapter; for DIN-35 rail; can be used as end plate; 6.5 mm wide

	gray	209-137	25
--	------	---------	----

Miniature Through Terminal Block TOPJOB® S; with Snap-In Mounting Foot 1 (1.5) mm²; 2050 Series

Technical Data

0.14 ... 1 (1.5) mm ² ①	24 ... 16 AWG
500 V/6 kV/3 ②	300 V, 10 A ③
I _N 13.5 A (17.5 A)	300 V, 10 A ④
Terminal block width: 3.5 mm / 0.138 inch	
9 ... 11 mm / 0.35 ... 0.43 inch	



Dimensions (in mm):

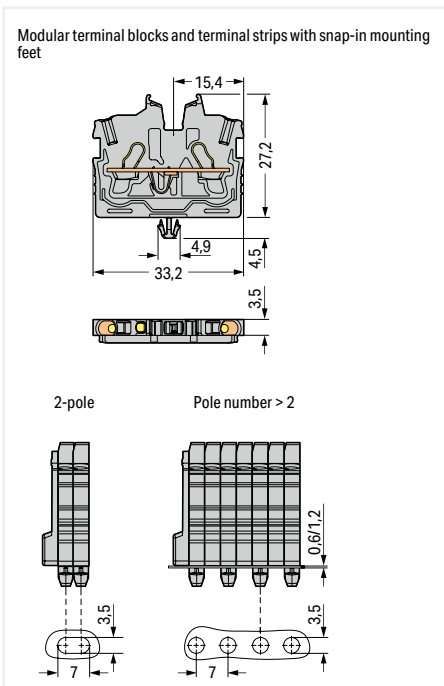

2-conductor miniature through terminal block; with snap-in mounting foot; for 0.6 ... 1.2 mm plate thickness; 3.5 mm mounting hole diameter; also for aluminum DIN-rail (210-154) or with mounting foot (209-120) for DIN-35 rail

Color	Item No.	Pack. Unit
gray ⑤	2050-311 ④	100
blue ⑤	2050-314 ③ ④	100
green-yellow ⑤	2050-317 ④	100

2-conductor miniature through terminal block; center terminal block; without snap-in mounting foot; without mounting flange; for 0.6 ... 1.2 mm plate thickness; required between end plate and end terminal block for terminal strips with mounting flanges

gray ⑤	2050-321 ④	100
blue ⑤	2050-324 ③ ④	100
green-yellow ⑤	2050-327 ④	100

① Conductor range: 0.14 ... 1.5 mm² "s+f-st"; Push-in termination: 0.5 ... 1.5 mm² "s" and 0.5 ... 0.75 mm² "insulated ferrules; 10 mm" Depending on the conductor characteristic, a conductor with a smaller cross section can also be inserted via push-in termination.

② 500 V = rated voltage
6 kV = rated impulse voltage
3 = pollution degree (see Section 15)

③ Terminal blocks with a blue insulated housing are suitable for Ex i applications.

④ Terminal blocks with an Ex mark are suitable for Ex e II applications.
352 V; 13.5 A
12 A jumper (see Section 15)

Please observe the application notes:
Jumpers, from page 174
Testing accessories, from page 168
Marking, from page 640

Approvals and corresponding ratings, visit www.wago.com

Accessories; 2050 Series

Appropriate marking systems:
WMB/WMB Inline/Marking strips

End plate; for terminal blocks with snap-in mounting foot; 3.4 mm thick

gray	2050-391	100 (25)
------	----------	----------

Push-in type jumper bar; insulated; I_N 14 A; light gray

2-way	2000-402	25
3-way	2000-403	25
4-way	2000-404	25
5-way	2000-405	25
6-way	2000-406	25
7-way	2000-407	25
8-way	2000-408	25
9-way	2000-409	25
10-way	2000-410	25

Push-in type jumper bar; insulated; I_N 14 A; light gray

1 to 3	2000-433	25
1 to 4	2000-434	25
1 to 5	2000-435	25
1 to 6	2000-436	25
1 to 7	2000-437	25
1 to 8	2000-438	25
1 to 9	2000-439	25
1 to 10	2000-440	25

Delta jumper; insulated; I_N = I_N terminal block; light gray

1-2 3-4 5-6	2000-406/020-000	25
-------------	------------------	----

Star point jumper; insulated; I_N = I_N terminal block; light gray

1-3-5	2000-405/011-000	25
-------	------------------	----

Push-in type wire jumper; insulated; 0.75 mm² conductor cross-section; I_N 9 A

L = 60 mm	2009-402	100 (10)
L = 110 mm	2009-404	100 (10)
L = 250 mm	2009-406	100 (10)

Protective warning marker; with black high-voltage symbol; for 5 terminal blocks

yellow	2000-115	100 (25)
--------	----------	----------

Accessories; 2050 Series

Appropriate marking systems:
WMB/WMB Inline/Marking strips

Modular connector; snaps together; for jumper contact slot
Terminal block width: 5 mm / 0.197 inch
Only for test purposes

gray	2000-511	100 (25)
------	----------	----------

Modular connector; snaps together; for jumper contact slot
Only for test purposes

gray	2000-510	100 (25)
------	----------	----------

Spacer module; snaps together; bridges commoned terminal blocks

gray	2000-549	100 (25)
------	----------	----------

Test plug; with 500 mm cable; 2 mm Ø; max. 42 V

red	210-136	50
-----	---------	----

Aluminum DIN-rail; 1000 mm long; 18 mm wide; 7 mm high

	210-154	1
--	---------	---

Plastic end stop; with WSB marker slot; for aluminum DIN-rail (210-154); 6 mm wide

	209-122	25
--	---------	----

Mounting foot; for DIN-35 rail; snaps onto terminal blocks with snap-in mounting foot; 6.4 mm wide

gray	209-120	25
------	---------	----

Mounting screw; for mounting foot (209-120)

	209-119	500 (50)
--	---------	----------

Mounting adapter; for DIN-35 rail; can be used as end plate; 6.5 mm wide











gray	209-137	25
------	---------	----



WAGO High-Current Rail-Mount Terminal Blocks

WAGO High-Current Rail-Mount Terminal Blocks

Side-Entry Wiring

			Page
	Through Terminal Blocks and Ground Conductor Terminal Blocks 6 ... 35 mm ² (10 ... 2 AWG)	285 Series	258
	Power Taps; for 35 mm² (2 AWG) Terminal Blocks 0.2 ... 6 mm ² (24 ... 10 AWG)	285 Series	258
	Through Terminal Blocks and Ground Conductor Terminal Blocks 10 ... 50 (70) mm ² (8 ... 1/0 AWG)	285 Series	262
	Power Taps; for 50 mm² (1/0 AWG) Terminal Blocks 0.2 ... 6 mm ² (24 ... 10 AWG)	285 Series	262
	Through Terminal Blocks; with Mounting Flanges 10 ... 50 (70) mm ² (8 ... 1/0 AWG)	285 Series	263
	Through Terminal Blocks and Ground Conductor Terminal Blocks 25 ... 95 mm ² (4 ... 4/0 AWG)	285 Series	264
	Power Taps; for 95 mm² (4/0 AWG) Terminal Blocks 0.2 ... 10 (16) mm ² (24 ... 8 AWG)	285 Series	264
	Through Terminal Blocks; with Mounting Flanges 25 ... 95 mm ² (4 ... 4/0 AWG)	285 Series	265
	Through Terminal Blocks and Ground Conductor Terminal Blocks 50 ... 185 mm ² (1/0 AWG ... 350 kcmil)	285 Series	266
	Power Taps; for 185 mm² (350 kcmil) Terminal Blocks 0.2 ... 10 (16) mm ² (24 ... 8 AWG)	285 Series	266
	Through Terminal Blocks; with Mounting Flanges 50 ... 185 mm ² (1/0 AWG ... 350 kcmil)	285 Series	267

High-Current Rail-Mount Terminal Blocks; 35 mm² 285 Series Description and Installation

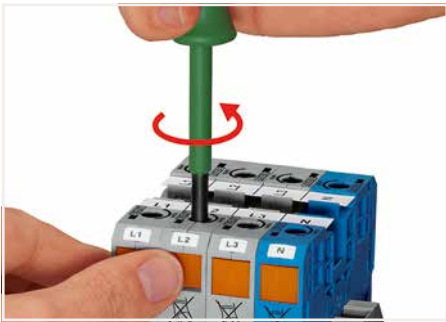

Conductor termination – step 1:
Rotate the operating tool (5.5 mm blade width) counter-clockwise. Next, push in the orange locking tab. The clamp is locked open for hands-free wiring.

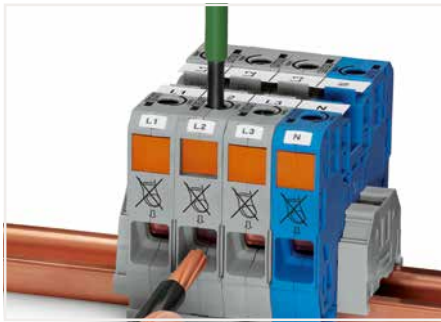

Conductor termination – step 2:
Insert a stripped conductor into the clamping unit until it hits backstop. Hold in this position.

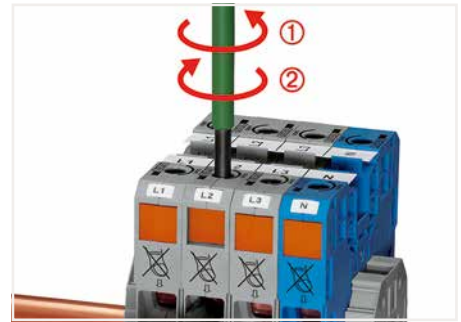

Conductor termination – step 3:
A short counter-clockwise rotation closes the clamp, securing the conductor ①. When unlocked, allow operating tool to rotate clockwise ② to securely terminate the conductor.

5



The power tap is inserted into the jumper contact slot. It can be fitted with a strain relief plate.



Testing
Voltage measurements can be performed (e.g., via 2-pole 206-707 Voltage Tester).



Testing with test plug adapter (283-404).



High-current rail-mount terminal blocks, 35 mm² (2 AWG) and 50 mm² (2/0 AWG)



POWER CAGE CLAMP
terminates the following
copper conductors:
solid "s"



stranded "st"



fine-stranded,
also with tinned
single strands

POWER CAGE CLAMP®



Commoning adjacent terminal blocks using a centrally positioned push-in jumper.



Slide the marking strip laterally to remove the jumper.



Commoning 35 mm² (2 AWG) POWER CAGE CLAMP Terminal Blocks with 10/16 mm² (8/6 AWG) 2010 and 2016 Series Terminal Blocks TOPJOB® S using step-down jumpers (not valid for 2016-76xx and 2016-77xx).



Step-down jumpers common terminal blocks of different sizes, without losing a conductor clamping point. This can be beneficial on long conductor runs where voltage drop can be a problem. A large conductor can be easily connected to smaller conductors at the distribution point.

Step-down jumpers are simply pushed down for full insertion, similar to adjacent jumpers. Commoning may be made in either direction using the special thin end plate to cover the open side. Additional through terminal blocks having a smaller cross-section may be commoned using adjacent jumpers.

In this case, pay attention that:
The total current of the outgoing circuits does not exceed the nominal current of the step-down jumper.

5



Side-entry wiring means that even larger conductors, which have limited flexibility, can be easily connected.



WMB markers or self-adhesive, printable marking strips can be accommodated on 35, 50 and 95 mm² high-current terminal blocks.



Marker carrier (285-442) for marking strip (2009-110) or 2 x WMB markers



fine-stranded, with ferrule (gastight crimped)



High-Current Through Terminal Block, High-Current Ground Conductor Terminal Block 35 mm²; 285 Series

Technical Data

6 ... 35 mm ²	8 ... 2 AWG
1000 V/8 kV/3 ①	600 V, 115 A ②
I _N 125 A	600 V, 115 A ③
Terminal block width: 16 mm / 0.63 inch	
25 mm / 0.98 inch	

Technical Data

0.2 ... 6 mm ²	24 ... 10 AWG
800 V/8 kV/3 ②	600 V, 30 A ③
I _N 32 A	600 V, 32 A ③
Module width: 8 mm / 0.315 inch	
12 ... 13 mm / 0.47 ... 0.51 inch	

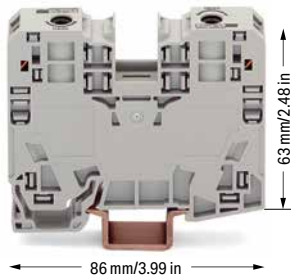

- ① 1000 V = rated voltage
8 kV = rated impulse voltage
3 = pollution degree
(see Section 15)
- ② 800 V = rated voltage
8 kV = rated impulse voltage
3 = pollution degree
(see Section 15)
- ③ Terminal blocks with an Ex mark are suitable for Ex e II applications.
880 V, 101 A
1 jumper, 85 A
4 ... 5 jumpers, 75 A
(see Section 15)

Please observe the application notes:
Step-down jumpers, see page 257
Marking, from page 640

Approvals and corresponding ratings,
visit www.wago.com

5

2-conductor through terminal block; only for DIN 35 x 15 rail

Color	Item No.	Pack. Unit
○ gray	285-135	15
● blue	285-134	15
○ light gray ③	285-935 ③	15
● dark gray/yellow	285-131	15

2-conductor ground terminal block; only suitable for DIN 35 x 15 rail; 1.5 mm and 2.3 mm thick

● green-yellow	285-137	15
● green-yellow ③	285-137/999-950 ③	15

Accessories; item-specific

Adjacent jumper; insulated; I_N 85 A

gray	285-435	50 (25)
------	---------	---------

Step-down jumper; insulated; I_N 90 A

gray	285-430	50 (25)
------	---------	---------

Protective warning marker; with a black high-voltage symbol

yellow	285-420	100 (25)
--------	---------	----------

Finger guard; touch-proof cover protects unused conductor entries

yellow	285-421	100 (25)
--------	---------	----------

Test plug adapter; 11.6 mm wide; for 4 mm Ø test plug; for 1.5 ... 16 mm² terminal blocks

gray	283-404	25
------	---------	----

Three-phase set; with 35 mm² high-current terminal blocks

285-139	1
---------	---

Power tap; I_N 24 A; with 500 mm cable; for 16 mm² (283/783 Series) and 35 mm² (285/785 Series) rail-mount terminal blocks

gray	283-407	25
------	---------	----

Operating tool with a partially insulated shaft; type 3; (5.5 x 0.8) mm blade

210-721	25 (1)
---------	--------

Power tap; for 35 mm² high-current terminal blocks

Color	Item No.	Pack. Unit
○ gray	285-427	5

Accessories; item-specific

Strain relief plate; gray

1-pole	769-410	100 (25)
--------	---------	----------

Test plug; with 500 mm cable; 2 mm Ø; max. 42 V

red	210-136	50 (1)
-----	---------	--------

WMB marking card; white; 10 strips with 10 markers/card; for 5 ... 17.5 mm terminal block width

plain	793-501	5
-------	---------	---

WMB marking card; white; 10 strips with 10 markers/card; 5 ... 5.2 mm stretchable

plain	793-5501	5
-------	----------	---

Accessories; for high-current terminal blocks

Appropriate marking systems:
WMB/WMB Inline/Marking strips

Copper DIN-rail; per EN 60715; 35 x 15 mm; 2.3 mm thick; 2 m long

unslotted	210-198	10
-----------	---------	----

Marking strip; plain; 11 mm wide; 50 m reel

white	2009-110	1
-------	----------	---

WMB marking card; white; 10 strips with 10 markers/card; for 5 ... 17.5 mm terminal block width

plain	793-501	5
-------	---------	---

WMB marking card; white; 10 strips with 10 markers/card; 5 ... 5.2 mm stretchable

plain	793-5501	5
-------	----------	---

Marker carrier; for POWER CAGE CLAMP 35/50/95 mm²; 10.4 mm wide

gray	285-442	25
------	---------	----

Screwless end stop; for DIN-35 rail; 14 mm wide

gray	249-197	10
------	---------	----

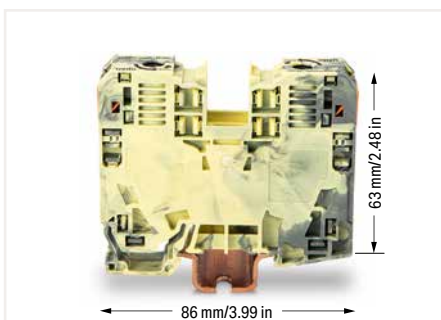

2-conductor through terminal block, dark gray/yellow (285-131), for ground connection without contact to the DIN-rail



Always push voltage tap (283-407) down into the terminal block until fully inserted!

High-Current Rail-Mount Terminal Blocks; 50 ... 185 mm² 285 Series Description and Installation



Conductor termination – step 1:
Rotate the T-wrench counter-clockwise to the stop ①. Next, push in the orange locking tab. The clamp is locked open for hands-free wiring.



Conductor termination – step 2:
Insert a stripped conductor into the clamping unit until it hits backstop. Hold in this position.



Conductor termination – step 3:
A short counter-clockwise rotation ② releases the tab. When unlocked, the T-wrench rotates clockwise, securely clamping the conductor.

5



For the optimal clamping force:

- Bend conductor.
- Cut conductor to length (conductor end must be straight).
- Stripping a conductor.



Always observe the printed strip length!



Grounding foot:
Ground conductor terminal blocks (limited to max. 120 mm²/250 kcmil per EN 60947-7-2) must be snapped onto a 2.3 mm thick copper DIN-rail.



Protective warning marker may indicate:
Notice: Power is still on even after switching off the main switch!



Risk of injury!
Do not insert fingers in the conductor entry!



Yellow, detachable finger guards provide touch-proof safety by shielding jumper contact slots and/or unused conductor entries.



POWER CAGE CLAMP terminates the following copper conductors:
solid "s"



stranded "st"



fine-stranded "f-st", also with tinned single strands

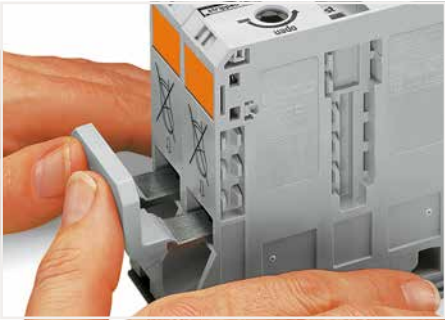

Commoning with an adjacent jumper: insert the jumper above the conductor entry hole – prior to conductor termination. The nominal cross-section remains unchanged.



Removing jumper via operating tool.

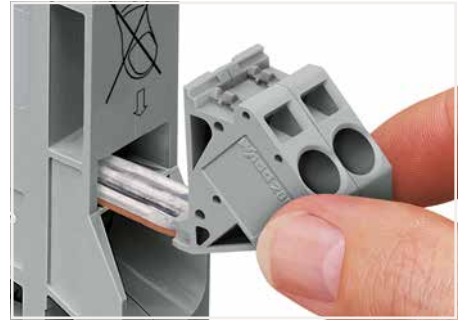

Reliably and easily tap directly into the power supply. Insert the unwired tap before opening the clamping unit.

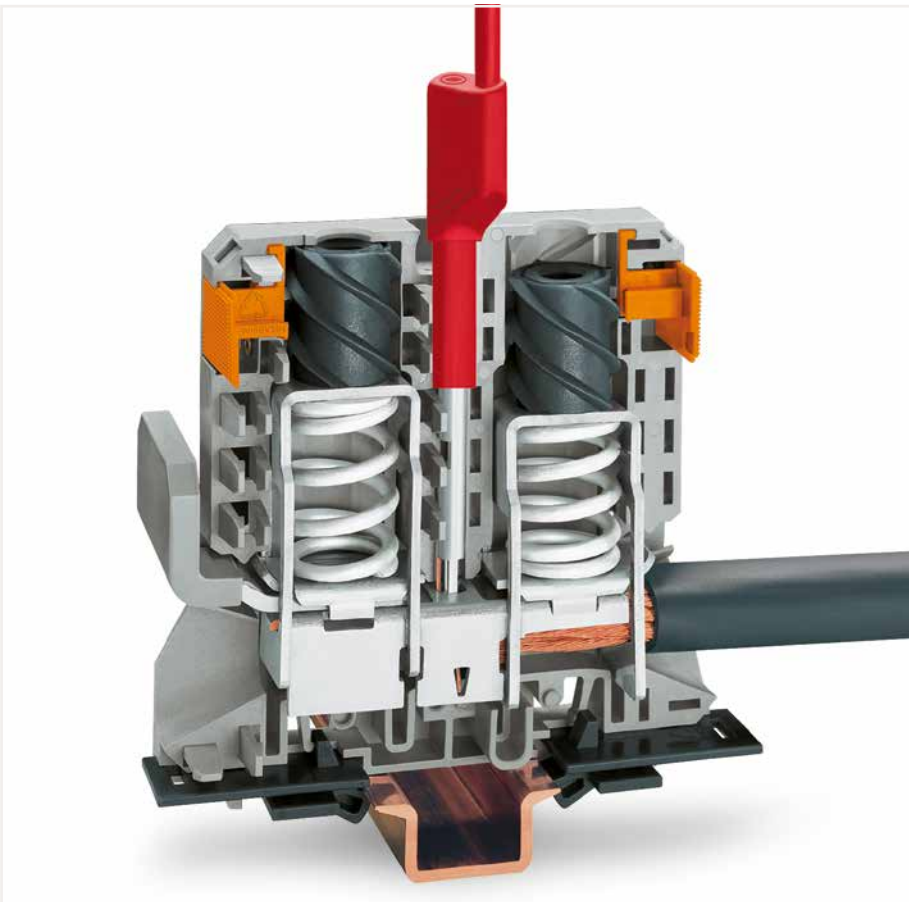

Testing via touch-proof 4 mm Ø test plugs (not available from WAGO, but offered by industry suppliers such as, Multi-Contact Deutschland GmbH).



Testing
Voltage measurements can be performed (e.g., via 2-pole 206-707 Voltage Tester).



WMB markers or self-adhesive, printable marking strips can be accommodated on 35, 50 and 95 mm² high-current terminal blocks.

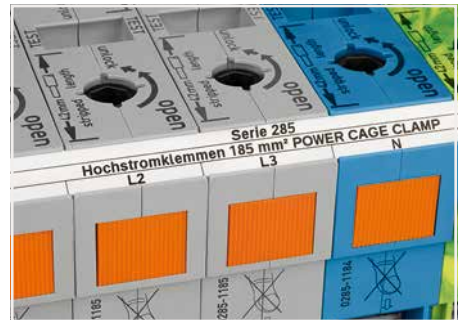

In addition to WMB markers, marking strips can be directly applied to 185 mm² (350 kcmil) high-current terminal blocks.



fine-stranded, with ferrule (gastight crimped)



High-Current Through Terminal Block, High-Current Ground Conductor Terminal Block

50 (70 "f-st") mm²; 285 Series

Technical Data

10 ... 50 (70 "f-st") mm ²	8 ... 1/0 AWG
1000 V/8 kV/3 ①	600 V, 150 A ^{NA}
I _N 150 A	600 V, 150 A ^{CE}
Terminal block width: 20 mm / 0.787 inch	
30 mm / 1.18 inch	

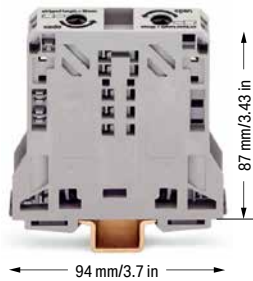

Technical Data

0.2 ... 6 mm ²	24 ... 10 AWG
1000 V/8 kV/3 ①	600 V, 30 A ^{NA}
I _N 41 A	600 V, 41 A ^{CE}
Module width: 16 mm / 0.63 inch	
12 ... 13 mm / 0.47 ... 0.51 inch	



- ① 1000 V = rated voltage
8 kV = rated impulse voltage
3 = pollution degree
(see Section 15)
- ② Terminal blocks with an Ex mark are suitable for Ex e II applications.
880 V, 134 A
(see Section 15)

Adjacent jumpers (285-450) can only be removed or inserted when the clamp is closed.

Please observe the application notes: Marking, from page 640

Approvals and corresponding ratings, visit www.wago.com

Accessories; for high-current terminal blocks

Appropriate marking systems:
WMB/WMB Inline/Marking strips

Marking strip; plain; 11 mm wide; 50 m reel

white	2009-110	1
-------	----------	---

WMB marking card; white; 10 strips with 10 markers/card; for 5 ... 17.5 mm terminal block width

plain	793-501	5
-------	---------	---

WMB marking card; white; 10 strips with 10 markers/card; 5 ... 5.2 mm stretchable

plain	793-5501	5
-------	----------	---

Marker carrier; for POWER CAGE CLAMP 35/50/95 mm²; 10.4 mm wide

gray	285-442	25
------	---------	----

5

2-conductor through terminal block; only for DIN 35 x 15 rail

Color	Item No.	Pack. Unit
gray	285-150	5
blue	285-154	5
light gray ②	285-950 ②	5
dark gray/yellow	285-151	5

2-conductor ground terminal block; only suitable for DIN 35 x 15 rail; 2.3 mm thick; copper

green-yellow	285-157	5
green-yellow ②	285-157/999-950 ②	5

Accessories; item-specific

Adjacent jumper; insulated; I_N 150 A, for 1 jumper; I_N 130 A, for 2 ... 4 jumpers

gray	285-450	100 (25)
------	---------	----------

Protective warning marker; with a black high-voltage symbol

yellow	285-440	50 (25)
--------	---------	---------

Protective warning marker; with a black high-voltage symbol

yellow	285-449	25
--------	---------	----

Finger guard; touch-proof cover protects unused conductor entries and jumper slots

yellow	285-441	100 (25)
--------	---------	----------

Three-phase set; with 50 mm² high-current terminal blocks

three-phase set	285-159	1
-----------------	---------	---

Copper DIN-rail; per EN 60715; 35 x 15 mm; 2.3 mm thick; 2 m long

unslotted	210-198	10
-----------	---------	----

Screwless end stop; for DIN-35 rail; 14 mm wide

gray	249-197	10
------	---------	----

T-wrench with a partially insulated shaft

T-wrench	285-172	1
----------	---------	---

Power tap; for 50 mm² high-current terminal blocks

Color	Item No.	Pack. Unit
gray	285-447	5

Accessories; item-specific

Protective warning marker; with black high-voltage symbol; for 5 terminal blocks

yellow	282-415	50 (25)
--------	---------	---------

WMB marking card; white; 10 strips with 10 markers/card; for 5 ... 17.5 mm terminal block width

plain	793-501	5
-------	---------	---

WMB marking card; white; 10 strips with 10 markers/card; 5 ... 5.2 mm stretchable

plain	793-5501	5
-------	----------	---

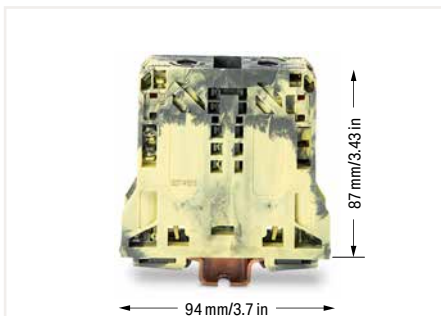

2-conductor through terminal block, dark gray/yellow (285-151), for ground connection without contact to the DIN-rail



Marker carrier (285-442) for marking strip (2009-110) or 2 x WMB markers

High-Current Through Terminal Block; with Mounting Flanges

50 (70 "f-st") mm²; 285 Series

Technical Data	
10 ... 50 (70 "f-st") mm ²	8 ... 1/0 AWG
1000 V/8 kV/3 ①	600 V, 150 A VA
I _N 150 A	600 V, 150 A Ⓢ
Terminal block width: 20 mm / 0.787 inch	
30 mm / 1.18 inch	

Technical Data	
10 ... 50 (70 "f-st") mm ²	8 ... 1/0 AWG
1000 V/8 kV/3 ①	600 V, 150 A VA
I _N 150 A	600 V, 150 A Ⓢ
Terminal block width: 20 mm / 0.787 inch	
30 mm / 1.18 inch	

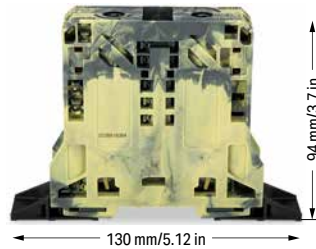

2-conductor through terminal block; with mounting flanges		
Color	Item No.	Pack. Unit
○ gray	285-141	5
● blue	285-144	5
○ light gray Ⓢ	285-143 ②	5

2-conductor through terminal block; with mounting flanges		
Color	Item No.	Pack. Unit
● dark gray/yellow	285-147	5
● dark gray/yellow Ⓢ	285-147/999-950 ②	5

Accessories; for high-current terminal blocks
Appropriate marking systems: WMB/WMB Inline/Marking strips

Adjacent jumper; insulated; I _N 150 A, for 1 jumper; I _N 130 A, for 2 ... 4 jumpers		
Color	Item No.	Pack. Unit
gray	285-450	100 (25)

Marking strip; plain; 11 mm wide; 50 m reel		
Color	Item No.	Pack. Unit
white	2009-110	1

Block-to-block connector; for 50 mm ² high-current terminal blocks		
Color	Item No.	Pack. Unit
orange	285-448	50 (25)

WMB marking card; white; 10 strips with 10 markers/card; for 5 ... 17.5 mm terminal block width		
Color	Item No.	Pack. Unit
plain	793-501	5

Protective warning marker; with a black high-voltage symbol		
Color	Item No.	Pack. Unit
yellow	285-440	50 (25)

WMB marking card; white; 10 strips with 10 markers/card; 5 ... 5.2 mm stretchable		
Color	Item No.	Pack. Unit
plain	793-5501	5

Protective warning marker; with a black high-voltage symbol		
Color	Item No.	Pack. Unit
yellow	285-449	25

Marker carrier; for POWER CAGE CLAMP 35/50/95 mm ² ; 10.4 mm wide		
Color	Item No.	Pack. Unit
gray	285-442	25

Finger guard; touch-proof covers unused conductor entries and jumper slots		
Color	Item No.	Pack. Unit
yellow	285-441	100 (25)

Three-phase set; with 50 mm ² high-current terminal blocks		
Item No.	Pack. Unit	
285-148	1	

Power tap; for 50 mm ² high-current terminal blocks		
Color	Item No.	Pack. Unit
gray	285-447	5

T-wrench with a partially insulated shaft		
Item No.	Pack. Unit	
285-172	1	

- ① 1000 V = rated voltage
8 kV = rated impulse voltage
3 = pollution degree
(see Section 15)
- ② Terminal blocks with an Ex mark are suitable for Ex e II applications.
880 V, 134 A
(see Section 15)

Adjacent jumpers (285-450) can only be removed or inserted when the clamp is closed.

Please observe the application notes: Marking, from page 640

Approvals and corresponding ratings, visit www.wago.com



Optionally, insert block-to-block connector (285-448) into housing slot.



Align and snap high-current, through terminal blocks together.

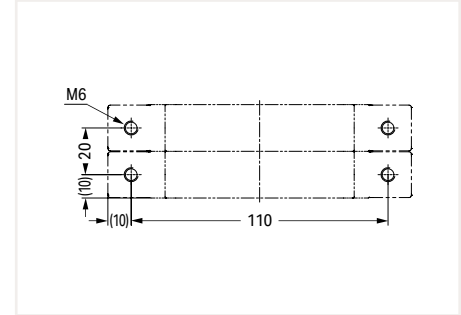

Dimensions (in mm):
Drill hole separation distance



High-Current Through Terminal Block, High-Current Ground Conductor Terminal Block 95 mm²; 285 Series

Technical Data	
25 ... 95 mm ²	4 ... 4/0 AWG
1000 VAC/DC/1500 VDC/12 kV/3	2 600 V, 200 A
I _N 232 A	1000 V, 210 A
Terminal block width: 25 mm / 0.984 inch	
35 mm / 1.38 inch	

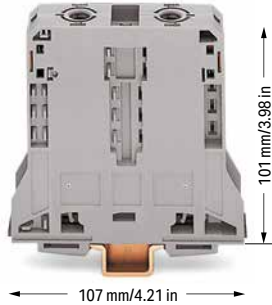

Technical Data	
0.2 ... 10 (16) mm ² 1	24 ... 8 AWG
1000 V/8 kV/3 2	600 V, 50 A
I _N 57 A	600 V, 57 A
Module width: 20 mm / 0.787 inch	
12 ... 13 mm / 0.47 ... 0.51 inch	



- 1 Power tap; for 95 mm² high-current terminal blocks
Max. conductor size: 16 mm²
- 2 1000 VAC/DC
1500 VDC = rated voltage
12 kV = rated impulse voltage
3 = pollution degree
(see Section 15)
- 3 1000 V = rated voltage
8 kV = rated impulse voltage
3 = pollution degree
- 4 Terminal blocks with an Ex mark are suitable for Ex e II applications.
25 ... 95 mm² / 4 ... 4/0 AWG
880 V, 211 A
1 jumper, 211 A
2 ... 4 jumpers, 175 A
35 ... 70 mm² / 2 ... 2/0 AWG
for ground conductor terminal blocks
(see Section 15)

Please observe the application notes:
Marking, from page 640

Approvals and corresponding ratings,
visit www.wago.com

Accessories; for high-current terminal blocks

Appropriate marking systems:
WMB/WMB Inline/Marking strips

Marking strip; plain; 11 mm wide; 50 m reel

white	2009-110	1
-------	----------	---

WMB marking card; white; 10 strips with 10 markers/card; for 5 ... 17.5 mm terminal block width

plain	793-501	5
-------	---------	---

WMB marking card; white; 10 strips with 10 markers/card; 5 ... 5.2 mm stretchable

plain	793-5501	5
-------	----------	---

Marker carrier; for POWER CAGE CLAMP 35/50/95 mm²; 10.4 mm wide

gray	285-442	25
------	---------	----



Marker carrier (285-442) for marking strip (2009-110) or 2 x WMB markers

5

2-conductor through terminal block; only for DIN 35 x 15 rail

Color	Item No.	Pack. Unit
gray	285-195	5
blue	285-194	5
light gray	285-995 1	5
dark gray/yellow	285-191	5

2-conductor ground terminal block; only suitable for DIN 35 x 15 rail; 2.3 mm thick; copper

green-yellow	285-197	5
green-yellow	285-197/999-950 1	5

Accessories; item-specific

Adjacent jumper; insulated; I_N 232 A, for 1 jumper; I_N 192 A, for 2 ... 4 jumpers

gray	285-495	25
------	---------	----

Protective warning marker; with a black high-voltage symbol

yellow	285-170	50 (25)
--------	---------	---------

Protective warning marker; with a black high-voltage symbol

yellow	285-175	25
--------	---------	----

Finger guard; touch-proof cover protects unused conductor entries and jumper slots

yellow	285-169	25
--------	---------	----

Three-phase set; with 95 mm² high-current terminal blocks

	285-199	1
--	---------	---

Copper DIN-rail; per EN 60715; 35 x 15 mm; 2.3 mm thick; 2 m long

unslotted	210-198	10
-----------	---------	----

Screwless end stop; for DIN-35 rail; 14 mm wide

gray	249-197	10
------	---------	----

T-wrench with a partially insulated shaft

	285-172	1
--	---------	---

Power tap; for 95 mm² high-current terminal blocks

Color	Item No.	Pack. Unit
gray	285-407	5

Accessories; item-specific

Protective warning marker; with black high-voltage symbol; for 5 terminal blocks

yellow	284-415	50 (25)
--------	---------	---------

WMB marking card; white; 10 strips with 10 markers/card; for 5 ... 17.5 mm terminal block width

plain	793-501	5
-------	---------	---

WMB marking card; white; 10 strips with 10 markers/card; 5 ... 5.2 mm stretchable

plain	793-5501	5
-------	----------	---

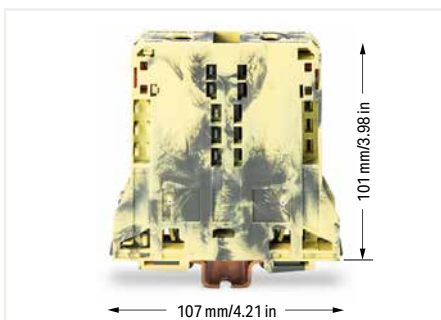

2-conductor through terminal block, dark gray/yellow (285-191), for ground connection without contact to the DIN-rail

High-Current Through Terminal Block; with Mounting Flanges

95 mm²; 285 Series

Technical Data	
25 ... 95 mm ²	4 ... 4/0 AWG
1000 V/8 kV/3 ①	600 V, 200 A ②
I _N 232 A	1000 V, 210 A ③
Terminal block width: 25 mm / 0.984 inch	
35 mm / 1.38 inch	

Technical Data	
25 ... 95 mm ²	4 ... 4/0 AWG
1000 V/8 kV/3 ①	600 V, 200 A ②
I _N 232 A	1000 V, 210 A ③
Terminal block width: 25 mm / 0.984 inch	
35 mm / 1.38 inch	

- ① 1000 V = rated voltage
8 kV = rated impulse voltage
3 = pollution degree
(see Section 15)
- Please observe the application notes:
Marking, from page 640
- Approvals and corresponding ratings,
visit www.wago.com

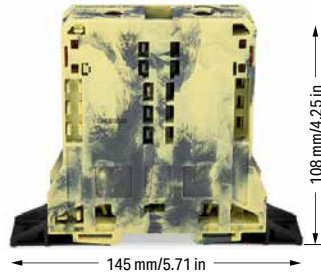

2-conductor through terminal block; with mounting flanges		
Color	Item No.	Pack. Unit
gray	285-181	5
blue	285-184	5

2-conductor through terminal block; with mounting flanges		
Color	Item No.	Pack. Unit
dark gray/yellow	285-187	5

Accessories; for high-current terminal blocks

Appropriate marking systems: WMB/WMB Inline/Marking strips

Adjacent jumper; insulated; I _N 232 A, for 1 jumper; I _N 192 A, for 2 ... 4 jumpers		
Color	Item No.	Pack. Unit
gray	285-495	25

Marking strip; plain; 11 mm wide; 50 m reel		
Color	Item No.	Pack. Unit
white	2009-110	1

Block-to-block connector; for 95 mm ² high-current terminal blocks		
Color	Item No.	Pack. Unit
orange	285-168	50 (25)

WMB marking card; white; 10 strips with 10 markers/card; for 5 ... 17.5 mm terminal block width		
Color	Item No.	Pack. Unit
plain	793-501	5

Protective warning marker; with a black high-voltage symbol		
Color	Item No.	Pack. Unit
yellow	285-170	25

WMB marking card; white; 10 strips with 10 markers/card; 5 ... 5.2 mm stretchable		
Color	Item No.	Pack. Unit
plain	793-5501	5

Protective warning marker; with a black high-voltage symbol		
Color	Item No.	Pack. Unit
yellow	285-175	25

Marker carrier; for POWER CAGE CLAMP 35/50/95 mm ² ; 10.4 mm wide		
Color	Item No.	Pack. Unit
gray	285-442	25

Finger guard; touch-proof cover protects unused conductor entries and jumper slots		
Color	Item No.	Pack. Unit
yellow	285-169	25

Three-phase set; with 95 mm ² high-current terminal blocks		
Item No.	Pack. Unit	
285-188	1	

Power tap; for 95 mm ² high-current terminal blocks		
Item No.	Pack. Unit	
285-407	5	

T-wrench with a partially insulated shaft		
Item No.	Pack. Unit	
285-172	1	



Optionally, insert block-to-block connector (285-168) into housing slot.



Align and snap high-current, through terminal blocks together.

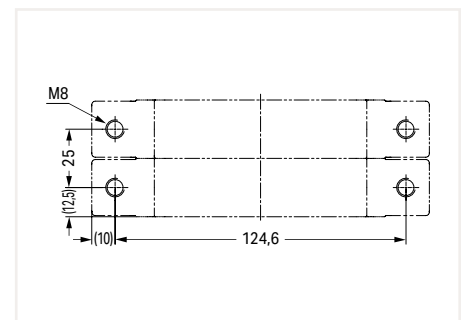

Dimensions (in mm):
Drill hole separation distance

5



High-Current Through Terminal Block, High-Current Ground Conductor Terminal Block 185 mm²; 285 Series

Technical Data

50 ... 185 mm ² ①	1/0 AWG ... 350 kcmil
1000 VAC/DC/1500 VDC/12 kV/3 ③ 600 V, 310 A ④	
I _N 353 A	1000 V, 310 A ⑥
Terminal block width: 32 mm / 1.26 inch	
45 ... 47 mm / 1.77 ... 1.85 inch	



Technical Data

0.2 ... 10 (16) mm ² ②	24 ... 8 AWG
1000 V/8 kV/3 ④	600 V, 50 A ④
I _N 57 A	600 V, 50 A ⑥
Module width: 20 mm / 0.787 inch	
12 ... 13 mm / 0.47 ... 0.51 inch	



- ① 50 ... 120 mm² / 1/0 AWG ... 250 kcmil for ground conductor terminal blocks (285-1187)
- ② Power tap; for 185 mm² high-current terminal blocks. Max. conductor size: 16 mm²
- ③ 1000 VAC/DC
1500 VDC = rated voltage
12 kV = rated impulse voltage
3 = pollution degree (see Section 15)
- ④ 1000 V = rated voltage
8 kV = rated impulse voltage
3 = pollution degree (see Section 15)
- ⑤ Terminal blocks with an Ex mark are suitable for Ex e II applications.
50 ... 185 mm² / 1/0 AWG ... 350 kcmil
1000 V, 250 A
1 jumper, 250 A
4 ... 5 jumpers, 236 A
50 ... 120 mm² / 1/0 AWG ... 250 kcmil for ground conductor terminal blocks (see Section 15)

Please observe the application notes:
Marking, from page 640

Approvals and corresponding ratings,
visit www.wago.com

Accessories; for high-current terminal blocks

Appropriate marking systems:
WMB/WMB Inline/Marking strips

Marking strip; plain; 11 mm wide; 50 m reel

white	2009-110	1
-------	----------	---

WMB marking card; white; 10 strips with 10 markers/card; for 5 ... 17.5 mm terminal block width

plain	793-501	5
-------	---------	---

WMB marking card; white; 10 strips with 10 markers/card; 5 ... 5.2 mm stretchable

plain	793-5501	5
-------	----------	---

Marker carrier; for POWER CAGE CLAMP 35/50/95 mm²; 10.4 mm wide

gray	285-442	25
------	---------	----

5

2-conductor through terminal block; only for DIN 35 x 15 rail

Color	Item No.	Pack. Unit
gray	285-1185	5
blue	285-1184	5
light gray ⑤	285-1189 ⑤	5
dark gray/yellow	285-1181	5

2-conductor ground terminal block; only suitable for DIN 35 x 15 rail; 2.3 mm thick; copper

green-yellow	285-1187	5
green-yellow ⑤	285-1187/999-950 ⑤	5

Accessories; item-specific

Adjacent jumper; insulated; I_N 309 A for 1 jumper

gray	285-1171	25
------	----------	----

Protective warning marker; with a black high-voltage symbol

yellow	285-1177	50 (25)
--------	----------	---------

Protective warning marker; with a black high-voltage symbol

yellow	285-1176	25
--------	----------	----

Finger guard; touch-proof cover protects unused conductor entries and jumper slots

yellow	285-1178	25
--------	----------	----

Three-phase set; with 185 mm² high-current terminal blocks

	285-1169	1
--	----------	---

Copper DIN-rail; per EN 60715; 35 x 15 mm; 2.3 mm thick; 2 m long

unslotted	210-198	10
-----------	---------	----

Screwless end stop; for DIN-35 rail; 14 mm wide

gray	249-197	10
------	---------	----

T-wrench with a partially insulated shaft

	285-172	1
--	---------	---

Power tap; for 185 mm² high-current terminal blocks

Color	Item No.	Pack. Unit
gray	285-1175	5

Accessories; item-specific

Protective warning marker; with black high-voltage symbol; for 5 terminal blocks

yellow	284-415	50 (25)
--------	---------	---------

WMB marking card; white; 10 strips with 10 markers/card; for 5 ... 17.5 mm terminal block width

plain	793-501	5
-------	---------	---

WMB marking card; white; 10 strips with 10 markers/card; 5 ... 5.2 mm stretchable

plain	793-5501	5
-------	----------	---



Tapping directly into the power supply.



In addition to WMB markers, marking strips can be directly applied to 185 mm² (350 kcmil) high-current terminal blocks.

High-Current Through Terminal Block; with Mounting Flanges 185 mm²; 285 Series

Technical Data	
50 ... 185 mm ²	1/0 AWG ... 350 kcmil
1000 VAC/DC/1500 VDC/12 kV/3 Ⓢ 600 V, 310 A A	
I _N 353 A	1000 V, 310 A Ⓢ
Terminal block width: 32 mm / 1.26 inch	
45 ... 47 mm / 1.77 ... 1.85 inch	

Technical Data	
50 ... 185 mm ²	1/0 AWG ... 350 kcmil
1000 VAC/DC/1500 VDC/12 kV/3 Ⓢ 600 V, 310 A A	
I _N 353 A	1000 V, 310 A Ⓢ
Terminal block width: 32 mm / 1.26 inch	
45 ... 47 mm / 1.77 ... 1.85 inch	

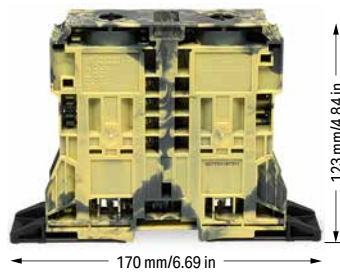

2-conductor through terminal block; with mounting flanges		
Color	Item No.	Pack. Unit
○ gray	285-1161	4
● blue	285-1164	4
○ light gray Ⓢ	285-1163 ②	4

2-conductor through terminal block; with mounting flanges		
Color	Item No.	Pack. Unit
● dark gray/yellow	285-1167	4
● dark gray/yellow Ⓢ	285-1167/999-950 ②	4

Accessories; for high-current terminal blocks
Appropriate marking systems: WMB/WMB Inline/Marking strips

Adjacent jumper; insulated; I _N 309 A for 1 jumper			
Color	Item No.	Pack. Unit	Image
gray	285-1171	25	

Marking strip; plain; 11 mm wide; 50 m reel			
Color	Item No.	Pack. Unit	Image
white	2009-110	1	

Block-to-block connector; for 185 mm ² high-current terminal blocks			
Color	Item No.	Pack. Unit	Image
orange	285-1179	50 (25)	

WMB marking card; white; 10 strips with 10 markers/card; for 5 ... 17.5 mm terminal block width			
Color	Item No.	Pack. Unit	Image
plain	793-501	5	

Protective warning marker; with a black high-voltage symbol			
Color	Item No.	Pack. Unit	Image
yellow	285-1177	50 (25)	

WMB marking card; white; 10 strips with 10 markers/card; 5 ... 5.2 mm stretchable			
Color	Item No.	Pack. Unit	Image
plain	793-5501	5	

Protective warning marker; with a black high-voltage symbol			
Color	Item No.	Pack. Unit	Image
yellow	285-1176	25	

Finger guard; touch-proof cover protects unused conductor entries and jumper slots			
Color	Item No.	Pack. Unit	Image
yellow	285-1178	25	

Three-phase set; with 185 mm ² high-current terminal blocks			
Item No.	Pack. Unit	Image	Image
285-1165	1		

Power tap; for 185 mm ² high-current terminal blocks			
Item No.	Pack. Unit	Image	Image
285-1175	5		

T-wrench with a partially insulated shaft			
Item No.	Pack. Unit	Image	Image
285-172	1		

- ① 1000 VAC/DC
1500 VDC = rated voltage
12 kV = rated impulse voltage
3 = pollution degree
(see Section 15)

- ② Terminal blocks with an Ex mark are suitable for Ex e II applications.
50 ... 185 mm² / 1/0 AWG ... 350 kcmil
1000 V, 250 A
1 jumper, 250 A
4 ... 5 jumpers, 236 A
(see Section 15)

Please observe the application notes:
Marking, from page 640

Approvals and corresponding ratings,
visit www.wago.com

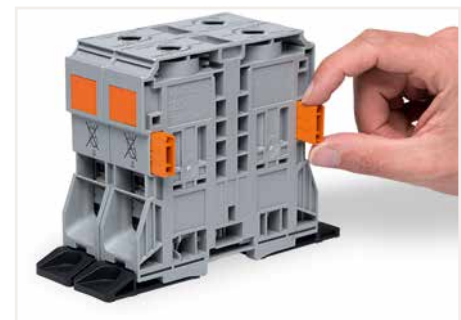

Optionally, insert block-to-block connector (285-1179) into housing slot.

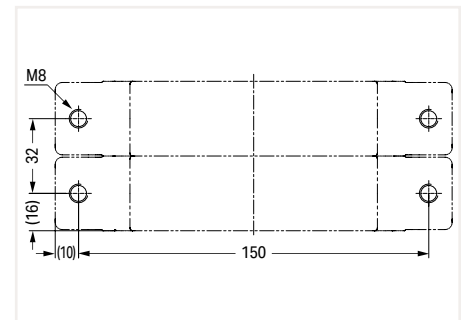

Dimensions (in mm):
Drill hole separation distance



Secure the terminal block to a mounting plate using two M8 cylinder-head screws and appropriate washers.

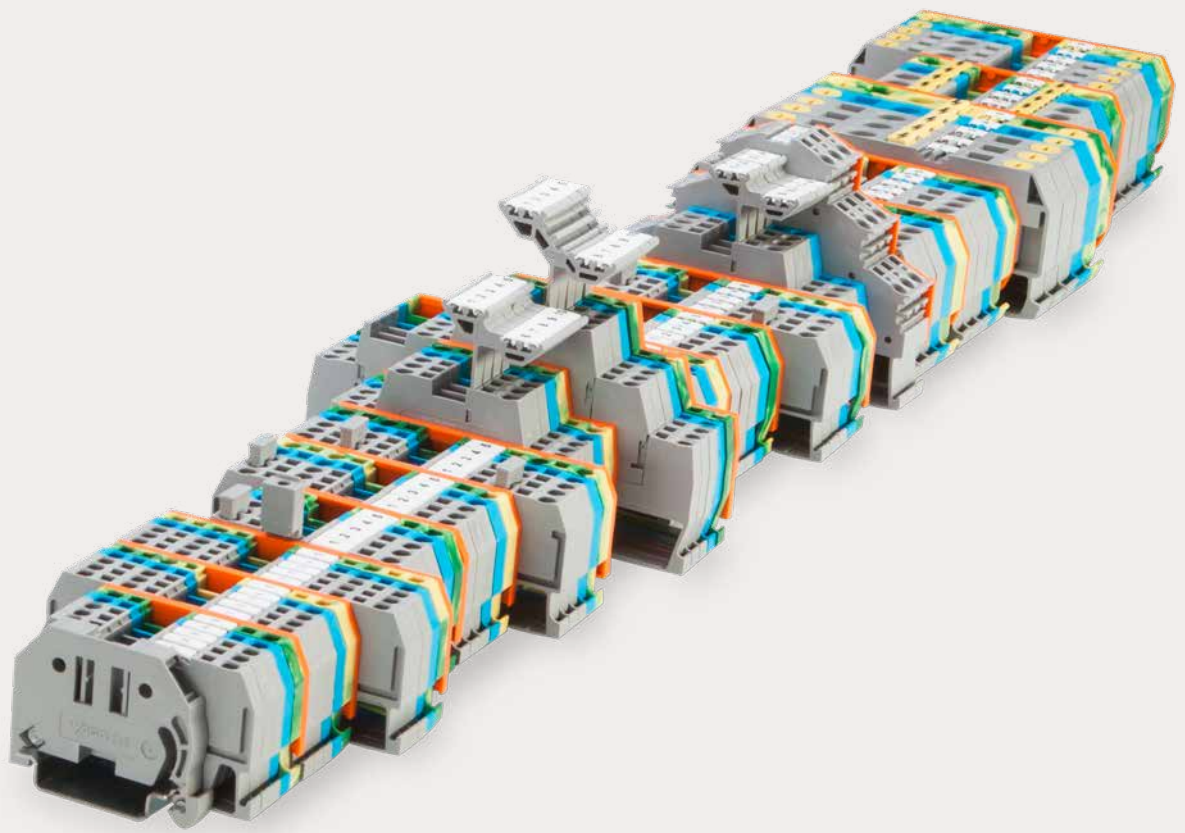

WAGO Rail-Mount Terminal Blocks Classic

WAGO Rail-Mount Terminal Blocks Classic

WAGO Installation Rail-Mount Terminal Blocks TOPJOB® Classic

Front-Entry Wiring

			Page
	Through/Ground Conductor/Shield Conductor and Ex Terminal Blocks 0.08 ... 35 mm ² (28 ... 2 AWG)	279 ... 285/880 Series	272
	Distribution Terminal Blocks 10 mm ² (8 AWG) / 35 mm ² (2 AWG)	284 Series	285
	Multilevel Rail-Mount Terminal Blocks 1.5/2.5/4 mm ² (16/12 AWG)	279/280/281 Series	288
	TOPJOB® Classic Through/Ground Conductor/Shield Conductor and Ex Terminal Blocks 0.08 ... 35 mm ² (28 ... 2 AWG)	780 ... 785 Series	303
	Disconnect/Test Terminal Blocks 0.08 ... 4 mm ² (28 ... 12 AWG) and 0.2 ... 6 mm ² (24 ... 10 AWG)	280/281/282 Series	312
	Disconnect/Ground Conductor Disconnect and Fuse Terminal Blocks 0.2 ... 6 mm ² (24 ... 10 AWG)	282 Series	328
	Fused Disconnect Terminal Blocks with a Pivoting Fuse Holder 0.08 ... 4 mm ² (28 ... 12 AWG)	281 Series	334
	Fuse Plugs on Carrier Terminal Blocks	281/280 Series	338
	Sensor and Actuator Terminal Blocks 0.08 ... 2.5 mm ² (28 ... 12 AWG)	280 Series	348
	Diode and LED Terminal Blocks 0.08 ... 4 mm ² (28 ... 12 AWG)	279/280/281 Series	364
	Multilevel Diode and LED Terminal Blocks 0.08 ... 4 mm ² (28 ... 12 AWG)	280/281 Series	370
	Diode and LED Modules	280 Series	374
	Accessories for Rail-Mount Terminal Blocks		378

Rail-Mount Terminal Blocks Classic

279 ... 285 and 880 Series

Description and Installation



By snapping a ground conductor terminal block onto the DIN-rail, a direct electrical connection is automatically made to the rail.



Quick assembly keys prevent reverse mounting.



Removing a terminal block from the assembly.

6

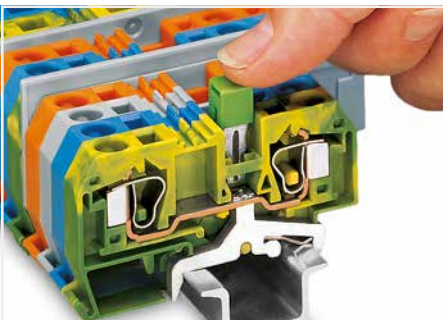

Commoning ground conductor terminal blocks with through terminal blocks is possible in one direction only (via rear side of terminal block) using adjacent jumpers. Recommends using yellow-green adjacent jumpers in addition to the required marking of these blocks.

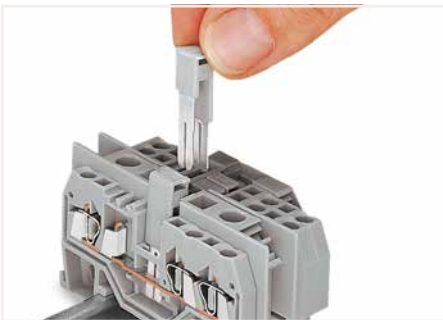

Commoning terminal blocks of different sizes via step-down jumpers.

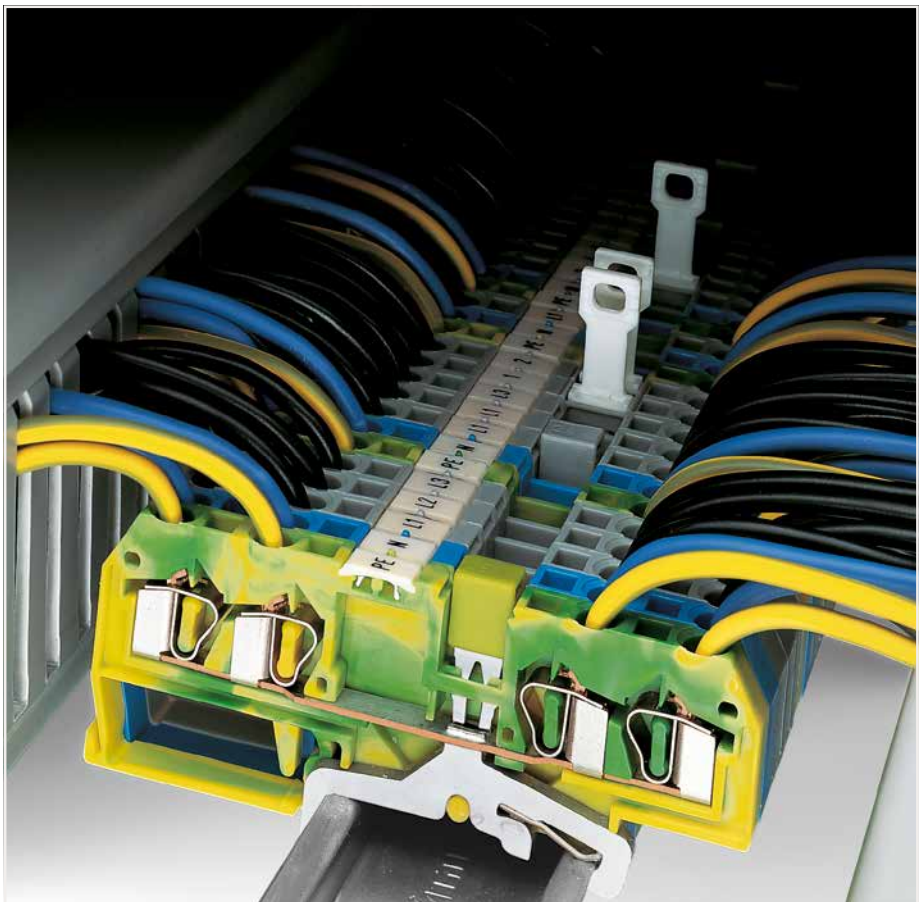

Steel DIN-rails are not suited for PEN (ground and N-conductor) applications per EN 60947-7-2 (VDE 0611, Part 3).



Staggered jumpers for sophisticated circuit requirements – push jumpers down until fully inserted.



880 Series Terminal Blocks have an additional test slot for the 2-pole voltage tester.



Protective warning markers inserted into the operating slots



CAGE CLAMP® terminates the following copper conductors: solid "s"



stranded "st"



fine-stranded "f-st", also with tinned single strands



CAGE CLAMP® connection
Inserting a conductor.



CAGE CLAMP® connection
Inserting a conductor.
With ferruled conductors, it is necessary to use a terminal block one size larger than the conductor's nominal cross section.



Testing with a test plug.
(picture shows a test plug fitted with CAGE CLAMP®)

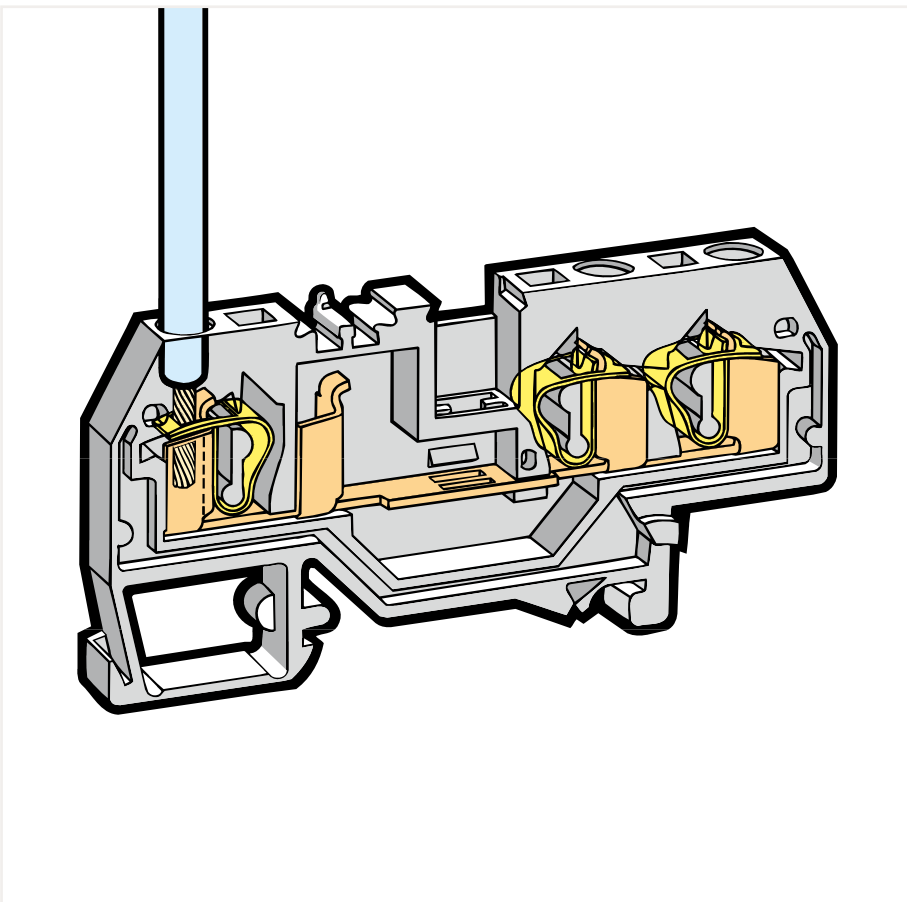

L-type test plug modules fitted with CAGE CLAMP®

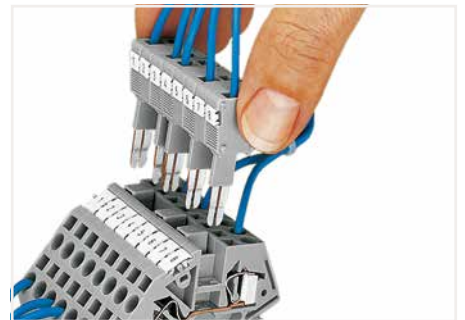

B-type test plug modules fitted with CAGE CLAMP®



Labeling via WMB Multi Marking System.

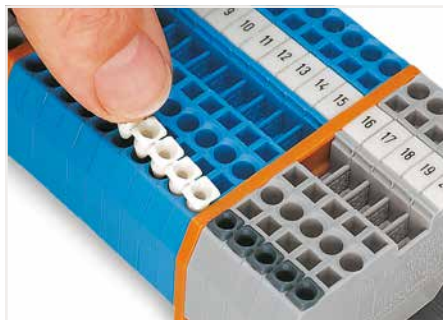

Inserting insulation stops.



Testing with a test plug.
(picture shows 209-170 Test Plug Adapter)



fine-stranded,
tip-bonded



fine-stranded,
with ferrule
(gastight crimped)



fine-stranded,
with pin terminal
(gastight crimped)

Through/Ground Conductor/Shield Conductor/Ex and Double-Potential Terminal Block 1.5 mm²; 279 Series

Technical Data	
0.08 ... 1.5 mm ²	28 ... 16 AWG
800 V/8 kV/3 ①	600 V, 10 A ②
I _N 18 A	600 V, 10 A ③
Terminal block width: 4 mm / 0.157 inch	
8 ... 9 mm / 0.31 ... 0.35 inch	

Technical Data	
0.08 ... 1.5 mm ²	28 ... 16 AWG
800 V/8 kV/3 ①	600 V, 10 A ②
I _N 18 A	600 V, 10 A ③
Terminal block width: 4 mm / 0.157 inch	
8 ... 9 mm / 0.31 ... 0.35 inch	

Technical Data	
0.08 ... 1.5 mm ²	28 ... 16 AWG
800 V/8 kV/3 ①	600 V, 10 A ②
I _N 18 A	600 V, 10 A ③
Terminal block width: 4 mm / 0.157 inch	
8 ... 9 mm / 0.31 ... 0.35 inch	

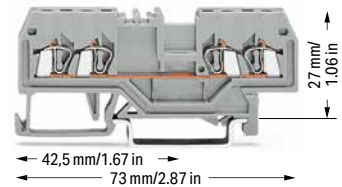
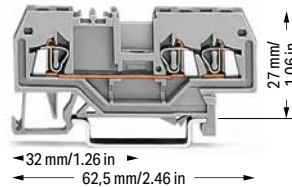
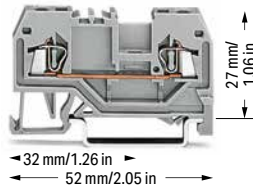

2-conductor through terminal block

Color	Item No.	Pack. Unit
gray	279-901	100
blue	279-904 ②	100
orange	279-902	100
red	279-903	100
black	279-905	100
yellow	279-906	100
light gray ③	279-992 ③	100

3-conductor through terminal block

Color	Item No.	Pack. Unit
gray	279-681	100
blue	279-684 ②	100
orange	279-682	100
red	279-683	100
black	279-685	100
yellow	279-686	100
light gray ③	279-993 ③	100

4-conductor through terminal block

Color	Item No.	Pack. Unit
gray	279-831	100
blue	279-834 ②	100
orange	279-832	100
red	279-833	100
black	279-835	100
yellow	279-836	100
light gray ③	279-994 ③	100

2-conductor ground terminal block

green-yellow	279-907	100
green-yellow ③	279-907/999-950 ③	100

3-conductor ground terminal block

green-yellow	279-687	100
green-yellow ③	279-687/999-950 ③	100

4-conductor ground terminal block

green-yellow	279-837	100
green-yellow ③	279-837/999-950 ③	100

4-conductor shield terminal block

white	279-838	100
-------	---------	-----

Other terminal blocks with the same profile:

Diode	279-915/281-410	Page 364
-------	-----------------	----------

Other terminal blocks with the same profile:

Diode	279-673/281-410	Page 364
-------	-----------------	----------

LED	279-674/281-434	Page 364
-----	-----------------	----------

Other terminal blocks with the same profile:

Diode	279-815/281-410	Page 364
-------	-----------------	----------

LED	279-809/281-434	Page 364
-----	-----------------	----------

Double-potential	279-826	Page 273
------------------	---------	----------

Accessories; item-specific

End and intermediate plate; 2 mm thick

orange	279-328	100 (25)
gray	279-325	100 (25)
light gray	279-330	100 (25)

Separator; oversized; 2 mm thick

orange	279-329	100 (25)
gray	279-326	100 (25)
light gray	279-331	100 (25)

Ex e/Ex i separator; orange; 3 mm thick

90 mm	209-190	50 (25)
120 mm	209-191	50 (25)

Accessories; item-specific

End and intermediate plate; 2 mm thick

orange	279-339	100 (25)
gray	279-308	100 (25)
light gray	279-341	100 (25)

Separator; oversized; 2 mm thick

orange	279-340	100 (25)
gray	279-309	100 (25)
light gray	279-342	100 (25)

Ex e/Ex i separator; orange; 3 mm thick

120 mm	209-191	50 (25)
--------	---------	---------

Accessories; item-specific

End and intermediate plate; 2 mm thick

orange	279-346	100 (25)
gray	279-344	100 (25)
light gray	279-348	100 (25)

Separator; oversized; 2 mm thick

orange	279-347	100 (25)
gray	279-345	100 (25)
light gray	279-349	100 (25)

Ex e/Ex i separator; orange; 3 mm thick

120 mm	209-191	50 (25)
--------	---------	---------

Step-down cover plate; 1 mm thick

gray	284-336	100 (25)
orange	284-346	100 (25)

Accessories; 279 Series

Appropriate marking systems: WMB/WMB Inline/WFB

Insulation stop; 0.08 ... 0.2 mm² "s" (0.14 mm² "f-st"); 5 pcs/strip

white	279-470	200 (25)
-------	---------	----------

Insulation stop; 0.25 mm²; 5 pcs/strip

dark gray	279-471	200 (25)
-----------	---------	----------

Adjacent jumper; insulated; I_N 15 A

gray	279-402	200 (25)
yellow-green	279-422	200 (25)

Alternate jumper; insulated; I_N 15 A

gray	279-409	100 (25)
------	---------	----------

Technical Data

0.08 ... 1.5 mm ²	28 ... 16 AWG
800 V/8 kV/3 ①	600 V, 10 A ②
I _N 18 A	600 V, 10 A ③
Terminal block width: 4 mm / 0.157 inch	
8 ... 9 mm / 0.31 ... 0.35 inch	

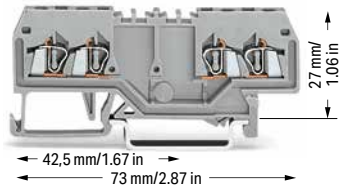

Double-potential terminal block; with double, center marking level

Color	Item No.	Pack. Unit
○ gray	279-826	100
○ light gray ④	279-995 ⑤	100

- 800 V = rated voltage
8 kV = rated impulse voltage
3 = pollution degree
(see Section 15)
- Terminal blocks with a blue insulated housing are suitable for Ex i applications.
- Terminal blocks with an Ex mark are suitable for Ex e II applications.
0.2 ... 1.5 mm² / 24 ... 16 AWG
550 V; 15 A
(see Section 15)

Please observe the application notes:
Insulation stop, page 382
Push-in type wire jumper, page 385
Step-down jumper, page 286
Comb-style jumper bar, page 383
Marking, from page 640

Approvals and corresponding ratings, visit www.wago.com

Accessories; 279 Series

Appropriate marking systems:
WMB/WMB Inline/WFB

Push-in type wire jumper; insulated; 0.75 mm² conductor cross section; I_N 9 A

L = 60 mm	249-125	100 (10)
L = 110 mm	249-126	100 (10)
L = 250 mm	249-127	100 (10)

Step-down jumper; insulated; commons 10/6 mm² (8/10 AWG) down to 4/2.5/1.5 mm² (12/14/16 AWG); I_N 15 A

gray	284-414	50 (25)
------	---------	---------

Cover plate; 1 mm thick; for 2-, 3- and 4-conductor terminal blocks

gray	284-334	100 (25)
orange	284-344	100 (25)

Comb-style jumper bar; insulated; I_N = I_N of terminal block

2-way	279-482	200 (25)
3-way	279-483	200 (25)

Comb-style jumper bar; insulated; I_N = I_N of terminal block

10-way	279-490	50 (25)
--------	---------	---------

Alternate comb-style jumper bar; insulated; I_N = I_N of terminal block

2-way	279-492	200 (25)
-------	---------	----------

Operating tool; insulated

2-way	279-432	1
3-way	279-433	1

Operating tool; insulated

10-way	279-440	1
--------	---------	---

Test plug adapter; 8.3 mm wide; for 4 mm Ø test plug; for 1.5 ... 10 mm² terminal blocks

gray	209-170	50 (25)
------	---------	---------

Test plug adapter; 5 mm wide; for 4 mm Ø test plug; for 1.5 ... 4 mm² terminal blocks

gray	280-404	100 (25)
------	---------	----------

Accessories; item-specific

End and intermediate plate; 2 mm thick

orange	279-346	100 (25)
gray	279-344	100 (25)
light gray	279-348	100 (25)

Separator; oversized; 2 mm thick

orange	279-347	100 (25)
gray	279-345	100 (25)
light gray	279-349	100 (25)

Protective warning marker; with black high-voltage symbol; for 5 terminal blocks

yellow	279-415	100 (25)
--------	---------	----------

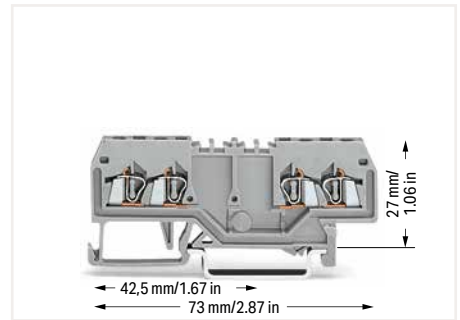

Notice: These double-potential terminal blocks cannot be commoned via adjacent jumpers!
Front-entry double-potential terminal blocks are space savers.
Two independent feedthrough circuits are placed in one insulated housing on one level in just 4 mm. This achieves a width of just 2 mm versus standard through terminal blocks.

Input and output of a circuit are placed on the same side of the terminal block. Both circuits can be individually marked according to input and output.

For technical data and accessories, see www.wago.com



Marking directly on the terminal block via WMB markers.



Terminal block marking with double marker carriers (209-128)
Terminal blocks with side marking (see online catalog at www.wago.com)

Through/Ground Conductor/Shield Conductor/Ex and Double-Potential Terminal Block 2.5 mm²; 280 Series

Technical Data	
0.08 ... 2.5 mm ²	28 ... 12 AWG*
800 V/8 kV/3 ①	600 V, 20 A ②
I _N 24 A	600 V, 25 A ③
Terminal block width: 5 mm / 0.197 inch	
8 ... 9 mm / 0.31 ... 0.35 inch	

Technical Data	
0.08 ... 2.5 mm ²	28 ... 12 AWG*
800 V/8 kV/3 ①	600 V, 20 A ②
I _N 24 A	600 V, 15 A ③
Terminal block width: 5 mm / 0.197 inch	
8 ... 9 mm / 0.31 ... 0.35 inch	

Technical Data	
0.08 ... 2.5 mm ²	28 ... 12 AWG*
800 V/8 kV/3 ①	600 V, 20 A ②
I _N 20 A	600 V, 25 A ③
Terminal block width: 5 mm / 0.197 inch	
8 ... 9 mm / 0.31 ... 0.35 inch	

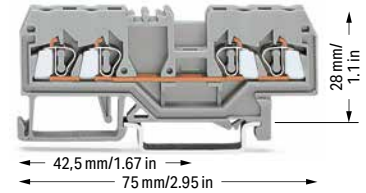
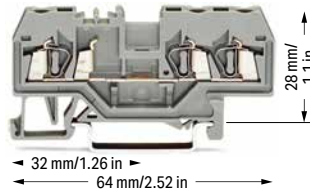
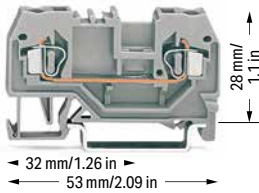

2-conductor through terminal block

Color	Item No.	Pack. Unit
gray	280-901	100
blue	280-904 ②	100
orange	280-902	100
red	280-903	100
black	280-905	100
yellow	280-906	100
light gray ⑤	280-992 ③	100

3-conductor through terminal block

Color	Item No.	Pack. Unit
gray	280-681	100
blue	280-684 ②	100
orange	280-650	100
red	280-653	100
black	280-671	100
yellow	280-672	100
light gray ⑤	280-993 ③	100

4-conductor through terminal block

Color	Item No.	Pack. Unit
gray	280-833	100
blue	280-834 ②	100
orange	280-835	100
red	280-830	100
black	280-831	100
yellow	280-832	100
light gray ⑤	280-994 ③	100

2-conductor ground terminal block

green-yellow	280-907	100
green-yellow ⑤	280-907/999-950 ④	100

3-conductor ground terminal block

green-yellow	280-687	100
green-yellow ⑤	280-687/999-950 ④	100

4-conductor ground terminal block

green-yellow	280-837	100
green-yellow ⑤	280-837/999-950 ④	100

4-conductor shield terminal block

white	280-838	100
-------	---------	-----

Other terminal blocks with the same profile:

Diode	280-915/281-410	Page 366
Disconnect	280-912	Page 314
Carrier	280-916	Page 340

Other terminal blocks with the same profile:

Diode	280-673/281-410	Page 366
Disconnect	280-683	Page 314
Carrier	280-610	Page 340

Other terminal blocks with the same profile:

Diode	280-815/281-410	Page 366
LED	280-809/281-434	Page 366
Disconnect	280-836	Page 314
Disc./test	280-829	Page 314
Carrier	280-816	Page 340
Double-potential	280-826	Page 275

Accessories; item-specific

End and intermediate plate; 2.5 mm thick

orange	280-309	100 (25)
gray	280-308	100 (25)
light gray	280-356	100 (25)

Separator; oversized; 2 mm thick

orange	280-311	100 (25)
gray	280-310	100 (25)
light gray	280-357	100 (25)

Ex e/Ex i separator; orange; 3 mm thick

90 mm	209-190	50 (25)
120 mm	209-191	50 (25)

Spacer with same profile; for 2-conductor terminal blocks of horizontal type; 5 mm thick

orange	280-902/056-000	100 (25)
--------	-----------------	----------

Accessories; item-specific

End and intermediate plate; 2.5 mm thick

orange	280-326	100 (25)
gray	280-324	100 (25)
light gray	280-358	100 (25)

Separator; oversized; 2 mm thick

orange	280-346	100 (25)
gray	280-344	100 (25)
light gray	280-359	100 (25)

Ex e/Ex i separator; orange; 3 mm thick

120 mm	209-191	50 (25)
--------	---------	---------

Spacer with same profile; for 3-conductor terminal blocks of horizontal type; 5 mm thick

orange	280-650/056-000	100 (25)
--------	-----------------	----------

Accessories; item-specific

End and intermediate plate; 2.5 mm thick

orange	280-315	100 (25)
gray	280-314	100 (25)
light gray	280-352	100 (25)

Separator; oversized; 2 mm thick

orange	280-335	100 (25)
gray	280-334	100 (25)
light gray	280-353	100 (25)

Ex e/Ex i separator; orange; 3 mm thick

120 mm	209-191	50 (25)
--------	---------	---------

Spacer with same profile; for 4-conductor terminal blocks of horizontal type; 5 mm thick

orange	280-835/056-000	100 (25)
--------	-----------------	----------

Step-down cover plate; 1 mm thick

gray	284-336	100 (25)
orange	284-346	100 (25)

6

Technical Data

0.08 ... 2.5 mm ²	28 ... 12 AWG*
800 V/8 kV/3 ①	600 V, 20 A ②
I _N 24 A	600 V, 25 A ③
Terminal block width: 5 mm / 0.197 inch	
8 ... 9 mm / 0.31 ... 0.35 inch	

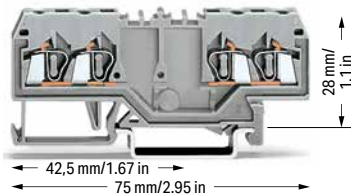

Double-potential terminal block; with double, center marking level

Color	Item No.	Pack. Unit
○ gray	280-826	100
○ light gray ④	280-995 ④	100

Notice: These double-potential terminal blocks cannot be commoned via adjacent jumpers!
 Front-entry double-potential terminal blocks are space savers.
 Two independent feedthrough circuits are placed in one insulated housing on one level in just 5 mm. This achieves a width of just 2.5 mm versus standard through terminal blocks.
 Input and output of a circuit are placed on the same side of the terminal block. Both circuits can be individually marked according to input and output.

For technical data and accessories, see www.wago.com

Accessories; item-specific

End and intermediate plate; 2.5 mm thick		
orange	280-315	100 (25)
gray	280-314	100 (25)
light gray	280-352	100 (25)
Separator; oversized; 2 mm thick		
orange	280-335	100 (25)
gray	280-334	100 (25)
light gray	280-353	100 (25)

* 12 AWG: THHN, THWN

- 800 V = rated voltage
8 kV = rated impulse voltage
3 = pollution degree
(see Section 15)
- Terminal blocks with a blue insulated housing are suitable for Ex i applications.
- Terminal blocks with an Ex mark are suitable for Ex e II applications.
0.2 ... 2.5 mm²/24 ... 12 AWG*
550 V
23 A, for 2-conductor terminal blocks
22 A, for 3-conductor terminal blocks
20 A, for 4-conductor terminal blocks
(see Section 15)
Using staggered jumpers reduces the maximum rated voltage to 275 V.

Please observe the application notes:
 Insulation stop, page 382
 Jumpers, from page 384
 Step-down jumper, page 286
 Comb-style jumper bar, page 383
 Testing accessories, from page 378
 Marking, from page 640

Approvals and corresponding ratings, visit www.wago.com

Accessories; 280 Series

Appropriate marking systems:
 WMB/WMB Inline/WFB

Insulation stop; 0.08 ... 0.2 mm² "s" (0.14 mm² "f-st"); 5 pcs/strip

white	280-470	200 (25)
-------	---------	----------



Insulation stop; 0.25 ... 0.5 mm²; 5 pcs/strip

light gray	280-471	200 (25)
------------	---------	----------



Insulation stop; 0.75 ... 1 mm²; 5 pcs/strip

dark gray	280-472	200 (25)
-----------	---------	----------



Protective warning marker; with black high-voltage symbol; for 5 terminal blocks

yellow	280-415	100 (25)
--------	---------	----------



Adjacent jumper; insulated; I_N = I_N terminal block

gray	280-402	200 (25)
yellow-green	280-422	200 (25)



Alternate jumper, insulated; I_N = I_N terminal block

gray	280-409	100 (25)
------	---------	----------



Staggered jumper; insulated; 5 mm wide; I_N 24 A

1 to 2	780-452	100 (25)
1 to 3	780-453	100 (25)
1 to 4	780-454	100 (25)
1 to 5	780-455	50 (25)
1 to 6	780-456	50 (25)
1 to 7	780-457	50 (25)
1 to 8	780-458	50 (25)



Push-in type wire jumper; insulated; 0.75 mm² conductor cross section; I_N 9 A

L = 60 mm	249-125	100 (10)
L = 110 mm	249-126	100 (10)
L = 250 mm	249-127	100 (10)



Accessories; 280 Series

Appropriate marking systems:
 WMB/WMB Inline/WFB

Step-down jumper; insulated; commons 10/6 mm² (8/10 AWG) down to 4/2.5/1.5 mm² (12/14/16 AWG); I_N 15 A

gray	284-414	50 (25)
------	---------	---------



Cover plate; 1 mm thick; for 2-, 3- and 4-conductor terminal blocks

gray	284-334	100 (25)
orange	284-344	100 (25)



Comb-style jumper bar; insulated; I_N = I_N of terminal block

2-way	280-482	200 (25)
3-way	280-483	200 (25)



Comb-style jumper bar; insulated; I_N = I_N of terminal block

10-way	280-490	50 (25)
--------	---------	---------



Alternate comb-style jumper bar; insulated; I_N = I_N of terminal block

2-way	280-492	200 (25)
-------	---------	----------



Operating tool; insulated

2-way	280-432	1
3-way	280-433	1



Operating tool; insulated

10-way	280-440	1
--------	---------	---



Test plug module; snaps together; 5 mm wide

gray	280-418	100 (25)
------	---------	----------



Spacer module; snaps together; 5 mm wide

gray	280-419	100 (25)
------	---------	----------



Test plug adapter; 8.3 mm wide; for 4 mm Ø test plug; for 1.5 ... 10 mm² terminal blocks

gray	209-170	50 (25)
------	---------	---------



Test plug adapter; 5 mm wide; for 4 mm Ø test plug; for 1.5 ... 4 mm² terminal blocks

gray	280-404	100 (25)
------	---------	----------



Test plug adapter; 6 mm wide; with CAGE CLAMP®; for 0.08 ... 2.5 mm²

I _N 24 A	281-407	100 (25)
---------------------	---------	----------



Through/Ground Conductor/Shield Conductor and Ex Terminal Block

2.5 mm²; 280 Series

Technical Data

0.08 ... 2.5 mm ²	28 ... 12 AWG*
800 V/8 kV/3 ①	600 V, 20 A ②
I _N 24 A	
Terminal block width: 5 mm / 0.197 inch	
8 ... 9 mm / 0.31 ... 0.35 inch	

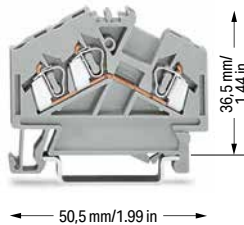

3-conductor through terminal block

Color	Item No.	Pack. Unit
gray	280-641	100
blue	280-651 ②	100
orange	280-654	100
light gray ③	280-998 ③	100

3-conductor ground terminal block

green-yellow	280-637	100
green-yellow ③	280-637/999-950 ③	100

3-conductor shield terminal block

white	280-640	100
-------	---------	-----

Accessories; 280 Series

Appropriate marking systems:
WMB/WMB Inline/WFB

End and intermediate plate; 2.5 mm thick

orange	280-313	100 (25)
gray	280-312	100 (25)
light gray	280-354	100 (25)

Separator; oversized; 2 mm thick

orange	280-318	100 (25)
gray	280-348	100 (25)
light gray	280-355	100 (25)

Ex e/Ex i separator; orange; 3 mm thick

120 mm	209-191	50 (25)
--------	---------	---------

Spacer with same profile; for 3- and 4-conductor terminal blocks (angled type); 5 mm thick

orange	280-654/056-000	100 (25)
--------	-----------------	----------

Insulation stop; 0.08 ... 0.2 mm² "s" (0.14 mm² "f-st"); 5 pcs/strip

white	280-470	200 (25)
-------	---------	----------

Insulation stop; 0.25 ... 0.5 mm²; 5 pcs/strip

light gray	280-471	200 (25)
------------	---------	----------

Insulation stop; 0.75 ... 1 mm²; 5 pcs/strip

dark gray	280-472	200 (25)
-----------	---------	----------

* 12 AWG: THHN, THWN

- 800 V = rated voltage
8 kV = rated impulse voltage
3 = pollution degree
(see Section 15)
- Terminal blocks with a blue insulated housing are suitable for Ex i applications.
- Terminal blocks with an Ex mark are suitable for Ex e II applications.
0.2 ... 2.5 mm² / 24 ... 12 AWG*
550 V; 23 A
(see Section 15)
Using staggered jumpers reduces the maximum rated voltage to 275 V.
- Please observe the application notes:
Insulation stop, page 382
Jumpers, from page 384
Comb-style jumper bar, page 383
Testing accessories, from page 378
Marking, from page 640

Approvals and corresponding ratings, visit www.wago.com

Accessories; 280 Series

Appropriate marking systems:
WMB/WMB Inline/WFB

Adjacent jumper; insulated; I_N = I_N terminal block

gray	280-402	200 (25)
yellow-green	280-422	200 (25)

Alternate jumper, insulated; I_N = I_N terminal block

gray	280-409	100 (25)
------	---------	----------

Staggered jumper; insulated; 5 mm wide; I_N 24 A

1 to 2	780-452	100 (25)
1 to 3	780-453	100 (25)
1 to 4	780-454	100 (25)
1 to 5	780-455	50 (25)
1 to 6	780-456	50 (25)
1 to 7	780-457	50 (25)
1 to 8	780-458	50 (25)

Push-in type wire jumper; insulated; 0.75 mm² conductor cross section; I_N 9 A

L = 60 mm	249-125	100 (10)
L = 110 mm	249-126	100 (10)
L = 250 mm	249-127	100 (10)

Comb-style jumper bar; insulated; I_N = I_N of terminal block

2-way	280-482	200 (25)
3-way	280-483	200 (25)

Comb-style jumper bar; insulated; I_N = I_N of terminal block

10-way	280-490	50 (25)
--------	---------	---------

Alternate comb-style jumper bar; insulated; I_N = I_N of terminal block

2-way	280-492	200 (25)
-------	---------	----------

Operating tool; insulated

2-way	280-432	1
3-way	280-433	1
10-way	280-440	1

Protective warning marker; with black high-voltage symbol; for 5 terminal blocks

yellow	280-415	100 (25)
--------	---------	----------

Accessories; 280 Series

Appropriate marking systems:
WMB/WMB Inline/WFB

Test plug module; snaps together; 5 mm wide

gray	280-418	100 (25)
------	---------	----------

Spacer module; snaps together; 5 mm wide

gray	280-419	100 (25)
------	---------	----------

Test plug adapter; 8.3 mm wide; for 4 mm Ø test plug; for 1.5 ... 10 mm² terminal blocks

gray	209-170	50 (25)
------	---------	---------

Test plug adapter; 5 mm wide; for 4 mm Ø test plug; for 1.5 ... 4 mm² terminal blocks

gray	280-404	100 (25)
------	---------	----------

Test plug adapter; 6 mm wide; with CAGE CLAMP®; for 0.08 ... 2.5 mm²

I _N 24 A	281-407	100 (25)
---------------------	---------	----------

WMB Inline, plain; 1,500 WMB markers (5 mm)/reel; 5 ... 5.2 mm stretchable

white	2009-115	1
-------	----------	---

WMB marking card; white; 10 strips with 10 markers/card; stretchable 5 ... 5.2 mm

plain	793-5501	5
-------	----------	---

6

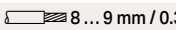

Through and Ex Terminal Block 2.5 mm²; 280 Series

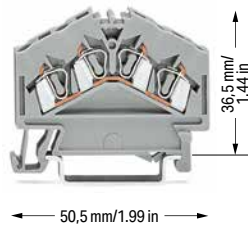

Technical Data	
0.08 ... 2.5 mm ²	28 ... 12 AWG*
800 V/8 kV/3 ①	600 V, 20 A ②
I _N 24 A	600 V, 25 A ③
Terminal block width: 5 mm / 0.197 inch	
 8 ... 9 mm / 0.31 ... 0.35 inch	





4-conductor through terminal block		
Notice: These terminal blocks cannot be commoned using adjacent jumpers.		
Color	Item No.	Pack. Unit
gray	280-646	100
blue	280-656 ②	100
orange	280-946	100
light gray ③	280-996 ③	100

Accessories; 280 Series	
Appropriate marking systems: WMB/WMB Inline/WFB	

End and intermediate plate; 2.5 mm thick		
 orange	280-313	100 (25)
 gray	280-312	100 (25)
 light gray	280-354	100 (25)

Separator; oversized; 2 mm thick		
 orange	280-318	100 (25)
 gray	280-348	100 (25)
 light gray	280-355	100 (25)

Ex e/Ex i separator; orange; 3 mm thick		
 120 mm	209-191	50 (25)

Spacer with same profile; for 3- and 4-conductor terminal blocks (angled type); 5 mm thick		
 orange	280-654/056-000	100 (25)

Insulation stop; 0.08 ... 0.2 mm ² "s" (0.14 mm ² "f-st"); 5 pcs/strip		
 white	280-470	200 (25)

Insulation stop; 0.25 ... 0.5 mm ² ; 5 pcs/strip		
 light gray	280-471	200 (25)

Insulation stop; 0.75 ... 1 mm ² ; 5 pcs/strip		
 dark gray	280-472	200 (25)

Protective warning marker; with black high-voltage symbol; for 5 terminal blocks		
 yellow	280-415	100 (25)

* 12 AWG: THHN, THWN

① 800 V = rated voltage
8 kV = rated impulse voltage
3 = pollution degree (see Section 15)



② Terminal blocks with a blue insulated housing are suitable for Ex i applications.

③ Terminal blocks with an Ex mark are suitable for Ex e II applications.
0.2 ... 2.5 mm² / 24 ... 12 AWG*
550 V; 23 A (see Section 15)

Please observe the application notes:
Insulation stop, page 382
Comb-style jumper bar, page 383
Testing accessories, from page 378
Marking, from page 640



Approvals and corresponding ratings, visit www.wago.com

Accessories; 280 Series
Appropriate marking systems:
WMB/WMB Inline/WFB

Comb-style jumper bar; insulated; I _N = I _N of terminal block			
 2-way	280-482	200 (25)	
 3-way	280-483	200 (25)	

Comb-style jumper bar; insulated; I _N = I _N of terminal block			
 10-way	280-490	50 (25)	

Alternate comb-style jumper bar; insulated; I _N = I _N of terminal block			
 2-way	280-492	200 (25)	

Operating tool; insulated			
 2-way	280-432	1	
 3-way	280-433	1	

Operating tool; insulated			
 10-way	280-440	1	

Test plug module; snaps together; 5 mm wide			
 gray	249-141	100 (25)	

WMB Inline, plain; 1,500 WMB markers (5 mm)/reel; 5 ... 5.2 mm stretchable			
 white	2009-115	1	

WMB marking card; white; 10 strips with 10 markers/card; stretchable 5 ... 5.2 mm			
 plain	793-5501	5	

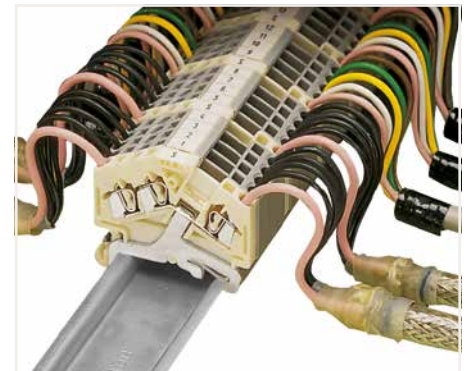

Application example for shield conductor terminal blocks

Shielded control cables are becoming an increasingly common solution to external signal interference. Front-entry shield conductor terminal blocks are ideal for connecting braided cables. Like front-entry ground conductor terminal blocks, they are equipped with a grounding foot for direct electrical connection to the rail, however they differ significantly by their white insulated housing. Shield conductor terminal blocks for front-entry wiring can be directly mounted beside signal-conductor terminal blocks, providing excellent deflection of interfering signals.

Through/Ground Conductor/Shield Conductor and Ex Terminal Block 4 mm²; 281 Series

Technical Data	
0.08 ... 4 mm ²	28 ... 12 AWG
800 V/8 kV/3 ①	600 V, 20 A ②
I _N 32 A	600 V, 25 A ③
Terminal block width: 6 mm / 0.236 inch	
9 ... 10 mm / 0.35 ... 0.39 inch	

Technical Data	
0.08 ... 4 mm ²	28 ... 12 AWG
800 V/8 kV/3 ①	600 V, 20 A ②
I _N 32 A	600 V, 25 A ③
Terminal block width: 6 mm / 0.236 inch	
9 ... 10 mm / 0.35 ... 0.39 inch	

Technical Data	
0.08 ... 4 mm ²	28 ... 12 AWG
800 V/8 kV/3 ①	600 V, 20 A ②
I _N 26 A	600 V, 25 A ③
Terminal block width: 6 mm / 0.236 inch	
9 ... 10 mm / 0.35 ... 0.39 inch	

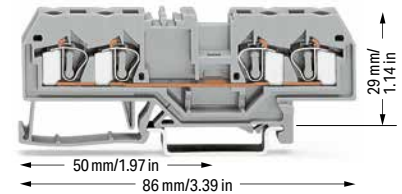
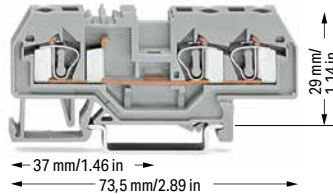
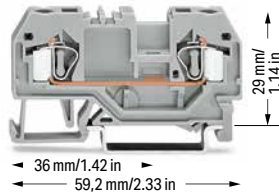

2-conductor through terminal block		
Color	Item No.	Pack. Unit
gray	281-901	50
blue	281-904 ②	50
orange	281-902	50
red	281-903	50
black	281-905	50
yellow	281-906	50
light gray ⑤	281-992 ③	50

3-conductor through terminal block		
Color	Item No.	Pack. Unit
gray	281-681	50
blue	281-684 ②	50
orange	281-678	50
red	281-679	50
black	281-685	50
yellow	281-686	50
light gray ⑤	281-993 ③	50

4-conductor through terminal block		
Color	Item No.	Pack. Unit
gray	281-652	50
blue	281-654 ②	50
orange	281-653	50
red	281-663	50
black	281-664	50
yellow	281-668	50
light gray ⑤	281-994 ③	50

2-conductor ground terminal block		
green-yellow	281-907	50
green-yellow ⑤	281-907/999-950 ③	50

3-conductor ground terminal block		
green-yellow	281-687	50
green-yellow ⑤	281-687/999-950 ③	50

4-conductor ground terminal block		
green-yellow	281-657	50
green-yellow ⑤	281-657/999-950 ③	50

4-conductor shield terminal block		
white	281-658	50

Other terminal blocks with the same profile:		
Diode	281-915/281-410	Page 368
Disconnect	281-912	Page 316
Carrier	281-916	Page 338

Other terminal blocks with the same profile:		
Diode	281-673/281-410	Page 368
Disconnect	281-683	Page 316
Carrier	281-610	Page 338

Other terminal blocks with the same profile:		
Diode	281-665/281-410	Page 368
Disconnect	281-659	Page 316
Disc./test	281-666	Page 316
Carrier	281-656	Page 338

Accessories; item-specific			
End and intermediate plate; 2.5 mm thick			
orange	281-329	100 (25)	
gray	281-328	100 (25)	
light gray	281-349	100 (25)	
Separator; oversized; 2 mm thick			
orange	281-331	100 (25)	
gray	281-330	100 (25)	
light gray	281-350	100 (25)	
Ex e/Ex i separator; orange; 3 mm thick			
90 mm	209-190	50 (25)	
120 mm	209-191	50 (25)	

Accessories; item-specific			
End and intermediate plate; 2.5 mm thick			
orange	281-326	100 (25)	
gray	281-324	100 (25)	
light gray	281-355	100 (25)	
Separator; oversized; 2 mm thick			
orange	281-346	100 (25)	
gray	281-344	100 (25)	
light gray	281-356	100 (25)	
Ex e/Ex i separator; orange; 3 mm thick			
120 mm	209-191	50 (25)	

Accessories; item-specific			
End and intermediate plate; 2.5 mm thick			
orange	281-335	100 (25)	
gray	281-334	100 (25)	
light gray	281-345	100 (25)	
Separator; oversized; 2 mm thick			
orange	281-339	100 (25)	
gray	281-338	100 (25)	
light gray	281-347	100 (25)	
Ex e/Ex i separator; orange; 3 mm thick			
120 mm	209-191	50 (25)	

Step-down cover plate; 1 mm thick		
gray	284-336	100 (25)
orange	284-346	100 (25)

Accessories; 281 Series

Appropriate marking systems: WMB/WMB Inline/WFB

Insulation stop; 0.08 ... 0.2 mm ² "s" (0.14 mm ² "f-st"); 5 pcs/strip		
white	281-470	200 (25)

Insulation stop; 0.25 ... 0.5 mm ² ; 5 pcs/strip		
light gray	281-471	200 (25)

Insulation stop; 0.75 ... 1.5 mm ² ; 5 pcs/strip		
dark gray	281-472	200 (25)

Technical Data

0.08 ... 4 mm ²	28 ... 12 AWG
800 V/8 kV/3 ①	600 V, 20 A ②
I _N 32 A	600 V, 25 A ③
Terminal block width: 6 mm / 0.236 inch	
9 ... 10 mm / 0.35 ... 0.39 inch	

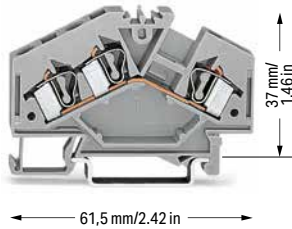

3-conductor through terminal block

Color	Item No.	Pack. Unit
gray	281-631	100
blue	281-651 ②	100
light gray ③	281-998 ③	100

3-conductor ground terminal block

green-yellow	281-637	100
green-yellow ③	281-637/999-950 ③	100

Accessories; item-specific

End and intermediate plate; 2.5 mm thick

	orange	281-313	100 (25)
	gray	281-312	100 (25)
	light gray	281-357	100 (25)

Separator; oversized; 2 mm thick

	orange	281-318	100 (25)
	gray	281-348	100 (25)
	light gray	281-358	100 (25)

Protective warning marker; with black high-voltage symbol; for 5 terminal blocks

	yellow	281-415	100 (25)
---	--------	---------	----------

① 800 V = rated voltage
8 kV = rated impulse voltage
3 = pollution degree
(see Section 15)

② Terminal blocks with a blue insulated housing are suitable for Ex i applications.

③ Terminal blocks with an Ex mark are suitable for Ex e II applications.
0.2 ... 4 mm² / 24 ... 12 AWG
550 V; 30 A
(see Section 15)
Using staggered jumpers reduces the maximum rated voltage to 275 V.

Please observe the application notes:
Insulation stop, page 382
Jumpers, from page 384
Comb-style jumper bar, page 383
Testing accessories, from page 378
Marking, from page 640

Approvals and corresponding ratings, visit www.wago.com

Accessories; 281 Series

Appropriate marking systems:
WMB/WMB Inline/WFB

Adjacent jumper; insulated; I_N = I_N terminal block

	gray	281-402	200 (25)
	yellow-green	281-422	200 (25)

Alternate jumper, insulated; I_N = I_N terminal block

	gray	281-409	100 (25)
---	------	---------	----------

Staggered jumper; insulated; 6 mm wide; I_N 32 A

	1 to 2	781-452	100 (25)
	1 to 3	781-453	100 (25)
	1 to 4	781-454	100 (25)
	1 to 5	781-455	50 (25)
	1 to 6	781-456	50 (25)

Push-in type wire jumper; insulated; 0.75 mm² conductor cross section; I_N 9 A

	L = 60 mm	249-125	100 (10)
	L = 110 mm	249-126	100 (10)
	L = 250 mm	249-127	100 (10)

Step-down jumper; insulated; commons 10/6 mm² (8/10 AWG) down to 6/4 mm² (10/12 AWG); I_N 30 A

	gray	284-413	50 (25)
---	------	---------	---------

Cover plate; 1 mm thick; for 2-, 3- and 4-conductor terminal blocks

	gray	284-334	100 (25)
	orange	284-344	100 (25)

Comb-style jumper bar; insulated; I_N = I_N of terminal block

	2-way	281-482	100 (25)
	3-way	281-483	100 (25)
	5-way	281-485	100 (25)
	10-way	281-490	50 (25)

Alternate comb-style jumper bar; insulated; I_N = I_N of terminal block

	2-way	281-492	100 (25)
---	-------	---------	----------

Operating tool; insulated

	2-way	280-432	1
	3-way	280-433	1
	5-way	281-440	1

Accessories; 281 Series

Appropriate marking systems:
WMB/WMB Inline/WFB

Test plug module; snaps together; 6 mm wide

	gray	281-418	100 (25)
---	------	---------	----------

Spacer module; snaps together; 6 mm wide

	gray	281-419	100 (25)
---	------	---------	----------

Test plug adapter; 8.3 mm wide; for 4 mm Ø test plug; for 1.5 ... 10 mm² terminal blocks

	gray	209-170	50 (25)
---	------	---------	---------

Test plug adapter; 5 mm wide; for 4 mm Ø test plug; for 1.5 ... 4 mm² terminal blocks

	gray	280-404	100 (25)
---	------	---------	----------

Test plug adapter; 6 mm wide; with CAGE CLAMP®; for 0.08 ... 2.5 mm²

	I _N 24 A	281-407	100 (25)
---	---------------------	---------	----------

WMB Inline, plain; 1,500 WMB markers (5 mm)/reel; 5 ... 5.2 mm stretchable

	white	2009-115	1
---	-------	----------	---

WMB marking card; white; 10 strips with 10 markers/card; stretchable 5 ... 5.2 mm

	plain	793-5501	5
---	-------	----------	---

Through/Ground Conductor and Ex Terminal Block 6 mm²; 282 Series

Technical Data

0.2 ... 6 mm ²	24 ... 10 AWG
800 V/8 kV/3 ①	600 V, 30 A ②
I _N 41 A	600 V, 40 A ③
Terminal block width: 8 mm / 0.315 inch	
12 ... 13 mm / 0.47 ... 0.51 inch	

Technical Data

0.2 ... 6 mm ²	24 ... 10 AWG
800 V/8 kV/3 ①	600 V, 30 A ②
I _N 41 A	600 V, 40 A ③
Terminal block width: 8 mm / 0.315 inch	
12 ... 13 mm / 0.47 ... 0.51 inch	

- ① 800 V = rated voltage
8 kV = rated impulse voltage
3 = pollution degree
(see Section 15)
- ② Terminal blocks with a blue insulated housing are suitable for Ex i applications.
- ③ Terminal blocks with an Ex mark are suitable for Ex e II applications.
0.5 ... 6 mm² / 20 ... 10 AWG
550 V; 39 A
35 A jumper
(see Section 15)

Please observe the application notes:
Step-down jumper, page 286
Test plug module, page 381
Marking, from page 640

Approvals and corresponding ratings,
visit www.wago.com

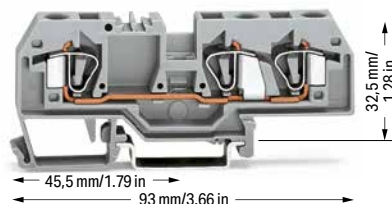
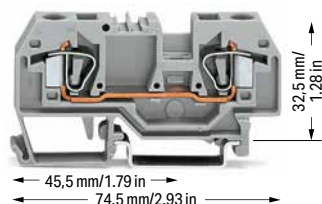

2-conductor through terminal block

Color	Item No.	Pack. Unit
gray	282-901	50
blue	282-904 ②	50
orange	282-902	50
light gray ③	282-992 ③	50

3-conductor through terminal block

Color	Item No.	Pack. Unit
gray	282-681	25
blue	282-684 ②	25
orange	282-682	25
light gray ③	282-993 ③	50

2-conductor ground terminal block

green-yellow	282-907	50
green-yellow ③	282-907/999-950 ③	50

3-conductor ground terminal block

green-yellow	282-687	25
green-yellow ③	282-687/999-950 ③	50

Accessories; item-specific

End and intermediate plate; 2.5 mm thick

orange	282-328	100 (25)
gray	282-325	100 (25)
light gray	282-330	100 (25)

Accessories; item-specific

End and intermediate plate; 2.5 mm thick

orange	282-339	100 (25)
gray	282-308	100 (25)
light gray	282-341	100 (25)

Separator; oversized; 2 mm thick

orange	282-329	100 (25)
gray	282-326	100 (25)
light gray	282-331	100 (25)

Separator; oversized; 2 mm thick

orange	282-340	100 (25)
gray	282-309	100 (25)
light gray	282-342	100 (25)

Step-down cover plate; 1 mm thick

gray	282-357	100 (25)
orange	282-367	100 (25)

Step-down cover plate; 1 mm thick

gray	282-358	100 (25)
orange	282-368	100 (25)

Accessories; 282 Series

Appropriate marking systems: WMB/WMB Inline/WFB

Ex e/Ex i separator; orange; 3 mm thick

120 mm	209-191	50 (25)
--------	---------	---------

Step-down jumper; insulated; commons 10/6 mm² (8/10 AWG) down to 6/4 mm² (10/12 AWG); I_N 30 A

gray	284-413	50 (25)
------	---------	---------

Protective warning marker; with black high-voltage symbol; for 5 terminal blocks

yellow	282-415	100 (25)
--------	---------	----------

Test plug adapter; 8.3 mm wide; for 4 mm Ø test plug; for 1.5 ... 10 mm² terminal blocks

gray	209-170	50 (25)
------	---------	---------

Adjacent jumper; insulated; I_N 41 A

gray	282-402	100 (25)
yellow-green	282-422	100 (25)

B-type test plug module; snaps together; 8 mm wide

gray	709-310	100 (25)
------	---------	----------

Alternate jumper; insulated; I_N 41 A

gray	282-409	100 (25)
------	---------	----------

B-type spacer module; snaps together; 5 mm wide

gray	709-311	100 (25)
------	---------	----------

Step-down jumper; insulated; commons 10/6 mm² (8/10 AWG) down to 4/2.5/1.5 mm² (12/14/16 AWG); I_N 15 A

gray	284-414	50 (25)
------	---------	---------

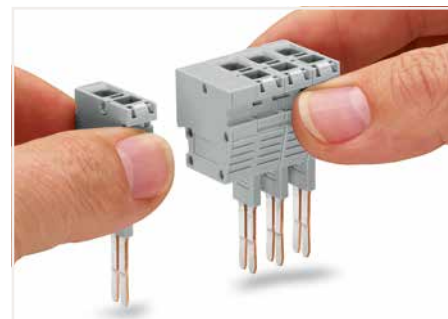

Snapping test plug and spacer modules together to assemble a multi-pole test plug module (max. 10 poles) for 8 mm terminal block width.

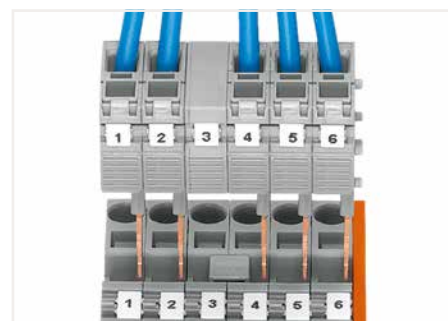

The test plug modules are directly plugged into the jumper contact slot of the current bar (picture shows 282 Series).

6

Through/Ground Conductor and Ex Terminal Block 10 mm²; 284 Series

Technical Data

0.2 ... 10 mm ²	24 ... 8 AWG
800 V/8 kV/3 ①	600 V, 50 A
I _N 57 A	600 V, 54 A
Terminal block width: 10 mm / 0.394 inch	
12 ... 13 mm / 0.47 ... 0.51 inch	

Technical Data

0.2 ... 10 mm ²	24 ... 8 AWG
800 V/8 kV/3 ①	600 V, 50 A
I _N 57 A	600 V, 54 A
Terminal block width: 10 mm / 0.394 inch	
12 ... 13 mm / 0.47 ... 0.51 inch	

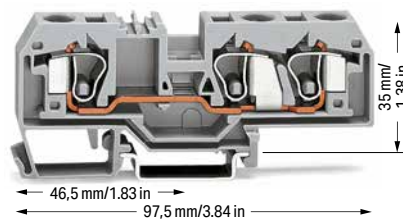
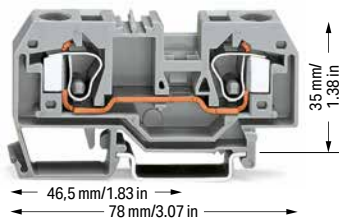

2-conductor through terminal block

Color	Item No.	Pack. Unit
gray	284-901	25
blue	284-904	25
orange	284-902	25
light gray	284-992 ②	25

3-conductor through terminal block

Color	Item No.	Pack. Unit
gray	284-681	25
blue	284-684	25
orange	284-682	25
light gray	284-993 ②	25

2-conductor ground terminal block

green-yellow	284-907	25
green-yellow	284-907/999-950 ②	25

3-conductor ground terminal block

green-yellow	284-687	25
green-yellow	284-687/999-950 ②	25

Accessories; item-specific

End and intermediate plate; 2.5 mm thick

orange	284-328	100 (25)
gray	284-325	100 (25)
light gray	284-330	100 (25)

Accessories; item-specific

End and intermediate plate; 2.5 mm thick

orange	284-339	100 (25)
gray	284-308	100 (25)
light gray	284-341	100 (25)

Separator; oversized; 2 mm thick

orange	284-329	100 (25)
gray	284-326	100 (25)
light gray	284-331	100 (25)

Separator; oversized; 2 mm thick

orange	284-340	100 (25)
gray	284-309	100 (25)
light gray	284-342	100 (25)

Step-down cover plate; 1 mm thick

gray	284-357	100 (25)
orange	284-367	100 (25)

Step-down cover plate; 1 mm thick

gray	284-358	100 (25)
orange	284-368	100 (25)

Accessories; 282 Series

Appropriate marking systems: WMB/WMB Inline/WFB

Protective warning marker; with black high-voltage symbol; for 5 terminal blocks

yellow	284-415	50 (25)
--------	---------	---------

Step-down jumper; insulated; commons 10/6 mm² (8/10 AWG) down to 6/4 mm² (10/12 AWG); I_N 30 A

gray	284-413	50 (25)
------	---------	---------

Finger guard; touch-proof cover protects unused conductor entries

yellow	284-400	100 (25)
--------	---------	----------

Test plug adapter; 8.3 mm wide; for 4 mm Ø test plug; for 1.5 ... 10 mm² terminal blocks

gray	209-170	50 (25)
------	---------	---------

Adjacent jumper; insulated; I_N 57 A

gray	284-402	100 (25)
yellow-green	284-422	100 (25)

B-type test plug module; snaps together; 8 mm wide

gray	709-310	100 (25)
------	---------	----------

Alternate jumper; insulated; I_N 57 A

gray	284-409	50 (25)
------	---------	---------

B-type spacer plate; snaps together; 2 mm wide

gray	709-312	100 (25)
------	---------	----------

Step-down jumper; insulated; commons 10/6 mm² (8/10 AWG) down to 4/2.5/1.5 mm² (12/14/16 AWG); I_N 15 A

gray	284-414	50 (25)
------	---------	---------

- 800 V = rated voltage
8 kV = rated impulse voltage
3 = pollution degree
(see Section 15)
- Terminal blocks with an Ex mark are suitable for Ex e II applications.
0.5 ... 10 mm² / 20 ... 8 AWG
550 V; 53 A
(see Section 15)

Please observe the application notes:
Step-down jumper, page 286
Test plug module, page 381
Marking, from page 640

Approvals and corresponding ratings,
visit www.wago.com

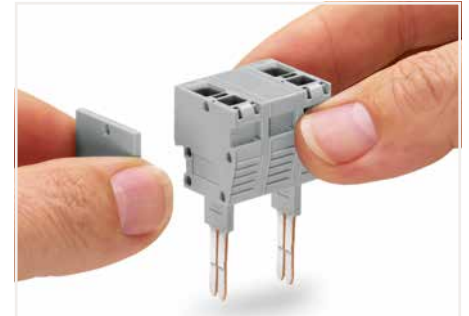

Snapping test plug and spacer modules (each with a spacer plate) together to assemble a multi-pole test plug module (max. 10 poles) for 10 mm terminal block width.



The test plug modules are directly plugged into the jumper contact slot of the current bar (picture shows 284 Series).



Finger guard seals an unused conductor entry.

Through/Ground Conductor and Ex Terminal Block 16 mm²; 283 Series

Technical Data

0.2 ... 16 mm²	24 ... 6 AWG
800 V/8 kV/3 ①	600 V, 65 A ②
I _N 76 A	600 V, 70 A ③
Terminal block width: 12 mm / 0.472 inch	
16 ... 17 mm / 0.63 ... 0.67 inch	

- ① 800 V = rated voltage
8 kV = rated impulse voltage
3 = pollution degree
(see Section 15)
- ② Terminal blocks with an Ex mark are suitable for Ex e II applications.
0.5 ... 16 mm² / 20 ... 6 AWG
550 V; 68 A
63 A jumper
(see Section 15)

Please observe the application notes:
Step-down jumper, page 286
Marking, from page 640

Approvals and corresponding ratings,
visit www.wago.com

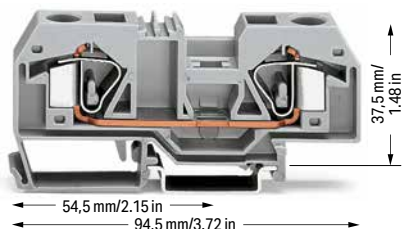

Accessories; 283 Series

Appropriate marking systems:
WMB/WMB Inline/WFB

Test plug adapter; 8.3 mm wide; for 4 mm Ø test plug; for 1.5 ... 10 mm² terminal blocks

	gray	283-404	25
--	------	---------	----

Power tap; I_N 24 A; with 500 mm cable; for 16 mm² (283/783 Series) and 35 mm² (285/785 Series) rail-mount terminal blocks

	gray	283-407	25
--	------	---------	----



The markers are not covered by the wiring when marking terminal blocks in center position.

2-conductor through terminal block

Color	Item No.	Pack. Unit
	283-901	20
	283-904	20
	283-902	20
	283-992 ②	20

2-conductor ground terminal block

	283-907	20
	283-907/999-950 ②	20

Accessories; 283 Series

Appropriate marking systems:
WMB/WMB Inline/WFB

End and intermediate plate; 2.5 mm thick

	orange	283-328	50 (25)
	gray	283-325	50 (25)
	light gray	283-330	50 (25)

Separator; oversized; 2 mm thick

	orange	283-329	50 (25)
	gray	283-326	50 (25)
	light gray	283-331	50 (25)

Protective warning marker; with black high-voltage symbol; for 5 terminal blocks

	yellow	283-415	50 (25)
--	--------	---------	---------

Finger guard; touch-proof cover protects unused conductor entries

	yellow	283-400	100 (25)
--	--------	---------	----------

Adjacent jumper; insulated; I_N 70 A

	gray	283-402	50 (25)
	yellow-green	283-422	50 (25)

Alternate jumper; insulated; I_N 76 A

	gray	283-409	50 (25)
--	------	---------	---------

Step-down jumper; insulated; commons 16 mm² (6 AWG) down to 4 mm² (12 AWG); I_N 32 A

	gray	283-414	50 (25)
--	------	---------	---------

Step-down cover plate; 1 mm thick

	gray	283-357	100 (25)
	orange	283-367	100 (25)



Always push voltage tap (283-407) down into the terminal block until fully inserted!

6

Through/Ground Conductor and Ex Terminal Block 16 mm²; 283 Series

Technical Data

0.2 ... 16 mm ²	24 ... 6 AWG
800 V/8 kV/3 ①	600 V, 65 A ②
I _N 76 A	600 V, 70 A ③
Terminal block width: 12 mm / 0.472 inch	
16 ... 17 mm / 0.63 ... 0.67 inch	

- 800 V = rated voltage
8 kV = rated impulse voltage
3 = pollution degree
(see Section 15)
- Terminal blocks with an Ex mark are suitable for Ex e II applications.
0.5 ... 16 mm² / 20 ... 6 AWG
550 V; 68 A
(see Section 15)

Please observe the application notes:
Marking, from page 640

Approvals and corresponding ratings,
visit www.wago.com

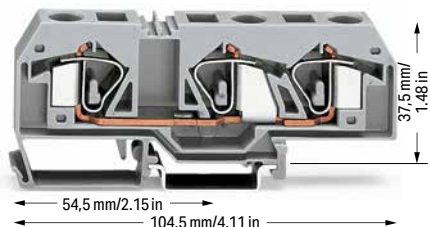

3-conductor through terminal block

Notice: This terminal block cannot be commoned with adjacent jumpers.

Color	Item No.	Pack. Unit
gray	283-671	20
blue	283-674	20
orange	283-672	20
light gray ⑤	283-998 ②	20

3-conductor ground terminal block

Notice: This terminal block cannot be commoned with adjacent jumpers.

green-yellow	283-677	20
green-yellow ⑤	283-677/999-950 ②	20



Finger guard seals an unused conductor entry.

Accessories; 283 Series

Appropriate marking systems:
WMB/WMB Inline/WFB

End and intermediate plate; 2.5 mm thick

orange	283-352	50 (25)
gray	283-350	50 (25)
light gray	283-354	50 (25)

Separator; oversized; 2 mm thick

orange	283-353	50 (25)
gray	283-351	50 (25)
light gray	283-355	50 (25)

Protective warning marker; with black high-voltage symbol; for 5 terminal blocks

yellow	283-415	50 (25)
--------	---------	---------



Finger guard; touch-proof cover protects unused conductor entries

yellow	283-400	100 (25)
--------	---------	----------



Through/Ground Conductor and Ex Terminal Block 35 mm²; 285 Series

Technical Data

6 ... 35 mm ²	10 ... 2 AWG
1000 V/8 kV/3 ①	600 V, 115 A W
I _N 125 A	600 V, 120 A Ⓢ
Terminal block width: 16 mm / 0.63 inch	
23 mm / 0.91 inch	

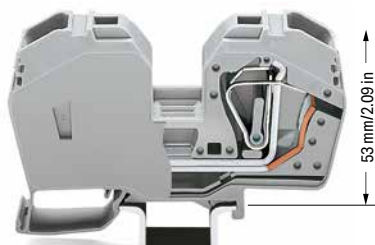

100 mm / 3.94 in

53 mm / 2.09 in

- ① 1000 V = rated voltage
8 kV = rated impulse voltage
3 = pollution degree
(see Section 15)
- ② Terminal blocks with an Ex mark are suitable for Ex e II applications.
6 ... 35 mm² / 8 ... 2 AWG
880 V; 85 A
6 ... 25 mm² / 8 ... 4 AWG
for ground conductor terminal blocks
(see Section 15)

Please observe the application notes:
Marking, from page 640

Approvals and corresponding ratings,
visit www.wago.com



Terminating a 35 mm² (2 AWG) conductor –

2-conductor through terminal block; with integrated end plate; only for DIN 35 x 15 rail

Color	Item No.	Pack. Unit
○ gray	285-635	15
● blue	285-634	15
○ light gray Ⓢ	285-992 Ⓢ	15

2-conductor ground terminal block; with integrated end plate; only for DIN 35 x 15 rail

● green-yellow	285-637	15
● green-yellow Ⓢ	285-637/999-950 Ⓢ	15

Accessories; 285 Series

Appropriate marking systems:
WMB/WMB Inline/WFB

Adjacent jumper; insulated; I_N 85 A

	gray	285-435	50 (25)
--	------	---------	---------

Step-down jumper; insulated; I_N 90 A

	gray	285-430	50 (25)
--	------	---------	---------

Protective warning marker; with a black high-voltage symbol

	yellow	285-416	100 (25)
--	--------	---------	----------

Finger guard; touch-proof cover protects unused conductor entries

	yellow	285-401	100 (25)
--	--------	---------	----------

Power tap; I_N 24 A; with 500 mm cable; for 16 mm² (283/783 Series) and 35 mm² (285/785 Series) rail-mount terminal blocks

	gray	283-407	25
--	------	---------	----



Protective warning markers inserted into the operating slots

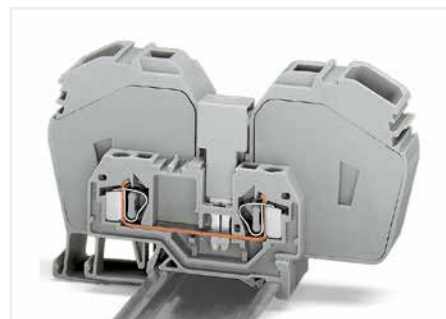

Commoning a 285 Series terminal block (35 mm²/ 2 AWG) with a 281 Series terminal block (4 mm²/ 12 AWG) using a step-down jumper (283-414).



Finger guard seals an unused conductor entry.

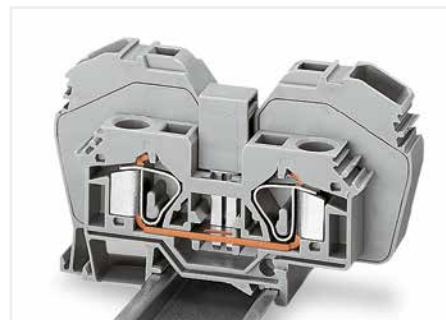

The following 285 Series Through Terminal Blocks can be commoned with 283 Series Through Terminal Blocks: 285-635 or 285-634 with 283-601 or 283-604 (terminal blocks with side marking, visit www.wago.com)
Adjacent jumper required: 285-435

Please note that the nominal current of the adjacent jumper must not exceed 63 A.

6

Distribution Terminal Block; 3 x 10 mm² CAGE CLAMP® Connection and 1 x 35 mm² Screw Clamp Connection

284 Series

Technical Data

0.2 ... 10 mm² ① | 24 ... 8 AWG6 ... 35 mm² ② | 10 ... 2 AWG

800 V/8 kV/3 ③

I_N 125 A

Terminal block width: 17.5 mm / 0.689 inch

 12 ... 14 mm / 0.47 ... 0.55 inch

- ① CAGE CLAMP® connection
- ② Screw-type connection
- ③ 800 V = rated voltage
8 kV = rated impulse voltage
3 = pollution degree
(see Section 15)
- ④ Individual arrangement: 125 A
Two jumpers combined in one clamping unit: 100 A

Please observe the application notes:
Marking, from page 640

Approvals and corresponding ratings,
visit www.wago.com

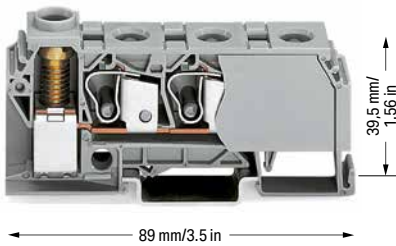

Terminating a 35 mm² (2 AWG) conductor – screw clamp connection, side-entry wiring

Distribution terminal block; with 3 x CAGE CLAMP® connection (10 mm²/8 AWG); 1 x screw clamp connection (35 mm²/2 AWG) and 3.5 Nm screw torque

Color	Item No.	Pack. Unit
○ gray	284-621	15
● blue	284-624	15

Accessories; distribution terminal block

Appropriate marking system:
WMB

Adjacent jumper; insulated; I_N 125 A; for 1 jumper;
I_N 100 A; for 2 jumpers

	gray	284-412 ④	100 (25)
---	------	-----------	----------

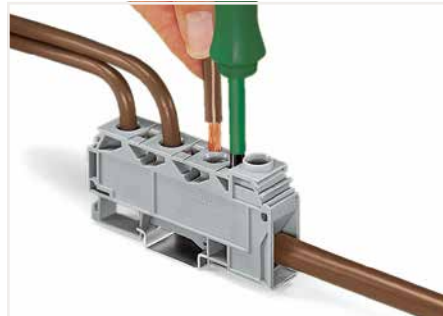

Terminating a 10 mm² (8 AWG) conductor – CAGE CLAMP® connection, front-entry wiring.



Commoning with comb-style jumper bar.

6

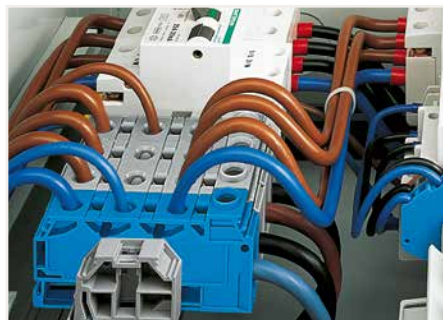

Side-entry distribution terminal block with screw clamp connection (35 mm²/2 AWG) and front-entry CAGE CLAMP® connection (3 x 10 mm²/8 AWG) snaps onto

This terminal block snaps onto DIN-35 rail – it is enclosed on both sides and requires no end or intermediate plate.

When connecting 3 x 10 mm² (8 AWG) conductors on the distribution side, make sure that the nominal current of 125 A is not exceeded.

Step-Down Jumpers; for Front-Entry Through Terminal Blocks up to 16 mm² Installation



Step-down jumper from 10/6 mm² (8/10 AWG) to 4/2.5/1.5 mm² (12/14/16 AWG)
I_N 15 A, Item No. 284-414



Step-down jumper from 10/6 mm² (8/10 AWG) to 6/4 mm² (10/12 AWG)
I_N 30 A, Item No. 284-413



Step-down jumper from 16 mm² (6 AWG) to 4 mm² (12 AWG)
I_N 32 A, Item No. 283-414

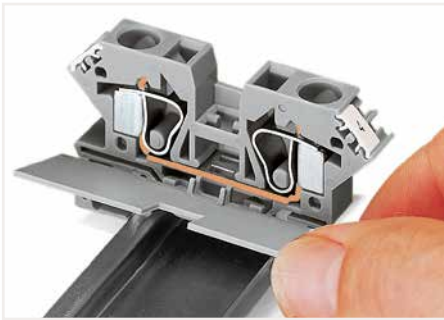

Snapping a cover plate onto open side of terminal block.

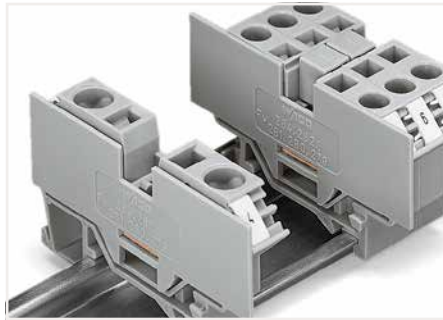

A cover plate must also be snapped onto the other side of the larger terminal block.



Commoning terminal blocks of different sizes – step down. Push down the step-down jumper until fully inserted.

Step-down jumpers common terminal blocks of different sizes, without losing a conductor clamping point. This can be beneficial on long conductor runs where voltage drop can be a problem. A large conductor can be easily connected to smaller conductors at the distribution point.

Step-down jumpers are simply pushed for full insertion, similar to adjacent jumpers. Commoning may be made in either direction using the special thin end plate to cover the open side. Additional through terminal blocks having a smaller cross section may be commoned using adjacent jumpers.

In this case, pay attention that:

- The total current of the outgoing circuits does not exceed the nominal current of the step-down jumper.
- The standard or special thin cover plate is installed on the open side of the larger block.



Note: Jumpers are marked with suitable terminal block sizes for correct installation.

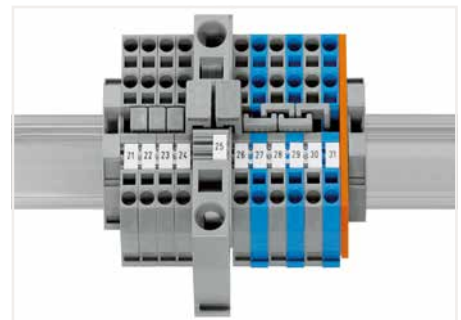

Commoning from 16 mm²/6 AWG (283 Series) to 4 mm²/12 AWG (281 Series) rail-mount terminal blocks via step-down jumpers.

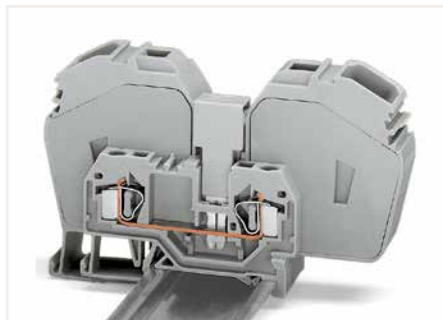

Commoning a 285 Series terminal block (35 mm²/ 2 AWG) with a 281 Series terminal block (4 mm²/ 12 AWG) using a step-down jumper (283-414).

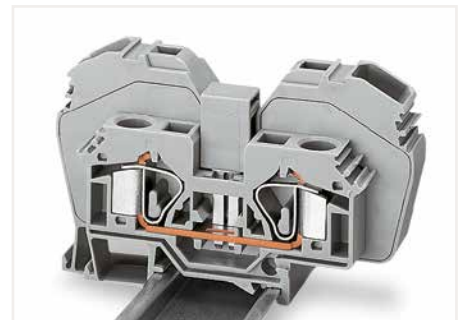

The following 285 Series Through Terminal Blocks can be commoned with 283 Series Through Terminal Blocks: 285-635 or 285-634 with 283-601 or 283-604 (terminal blocks with side marking, visit www.wago.com)
Adjacent jumper required: 285-435

Please note that the nominal current of the adjacent jumper must not exceed 63 A.

Assembly Examples

Step-Down Jumpers; for Front-Entry Through Terminal Blocks

Terminal blocks with side marking, visit www.wago.com

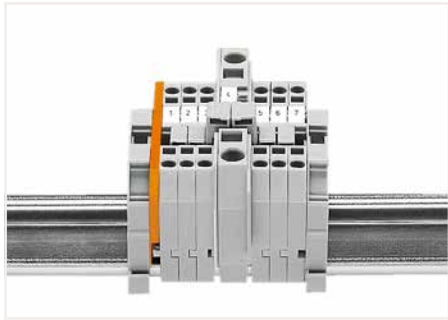

Commoning from 6 mm²/10 AWG (282 Series) to 1.5 mm²/16 AWG (279 Series) rail-mount terminal blocks via step-down jumpers.



Commoning from 10 mm²/8 AWG (284 Series) to 6 mm²/10 AWG (282 Series) rail-mount terminal blocks via step-down jumpers.

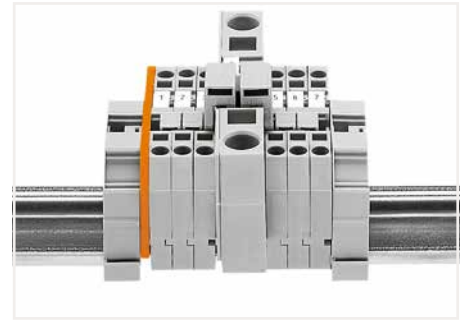

Commoning from 16 mm²/6 AWG (283 Series) to 4 mm²/12 AWG (281 Series) rail-mount terminal blocks via step-down jumpers.

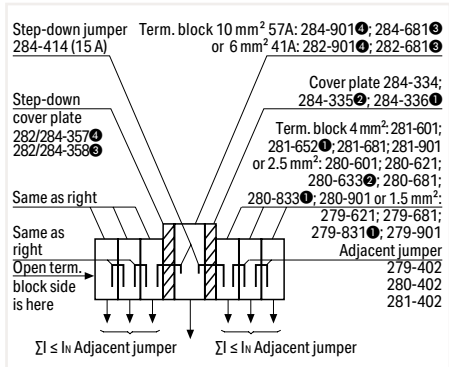

Assembly example: Commoning from 10/6 mm² (8/10 AWG) to 4/2.5/1.5 mm² (12/14/16 AWG) rail-mount terminal blocks via step-down jumper (284-414).

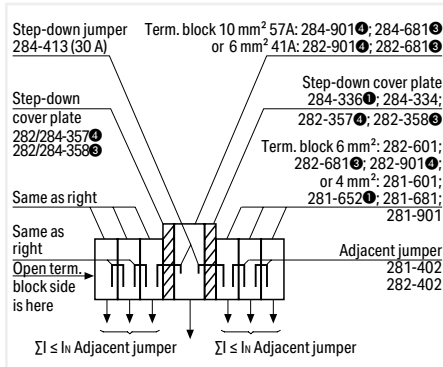

Assembly example: Commoning from 10/6 mm² (8/10 AWG) to 6 mm² (10 AWG) rail-mount terminal blocks via step-down jumper (284-413).

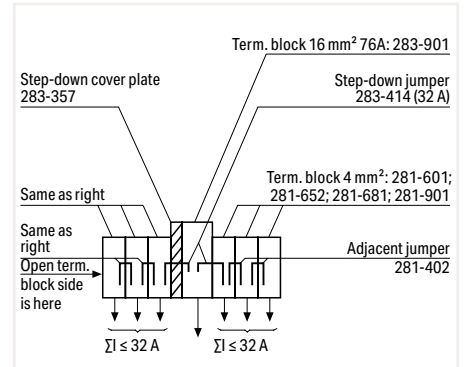

Assembly example: Commoning from 16 mm²/6 AWG to 4 mm²/12 AWG rail-mount terminal blocks via step-down jumper (283-414).

6



Commoning from 6 mm²/10 AWG (282 Series) to 1.5 mm²/16 AWG (279 Series) rail-mount terminal blocks via step-down jumpers.



Commoning from 10 mm²/8 AWG (284 Series) to 6 mm²/10 AWG (282 Series) rail-mount terminal blocks via step-down jumpers.

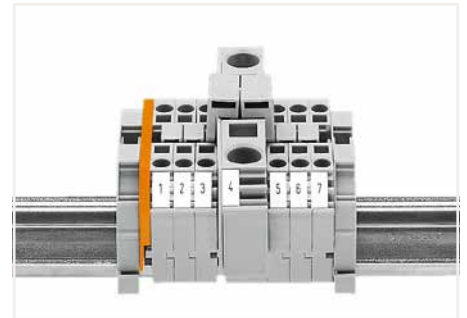

Commoning from 16 mm²/6 AWG (283 Series) to 4 mm²/12 AWG (281 Series) rail-mount terminal blocks via step-down jumpers.

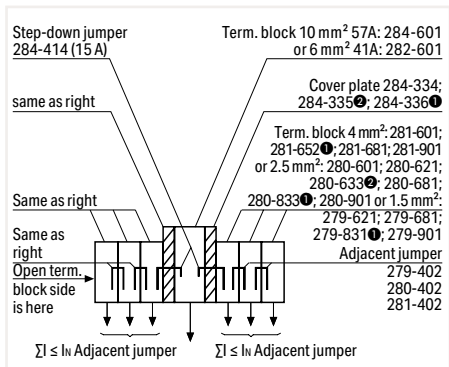

Assembly example: Commoning from 10/6 mm² (8/10 AWG) to 4/2.5/1.5 mm² (12/14/16 AWG) rail-mount terminal blocks via step-down jumper (284-414).

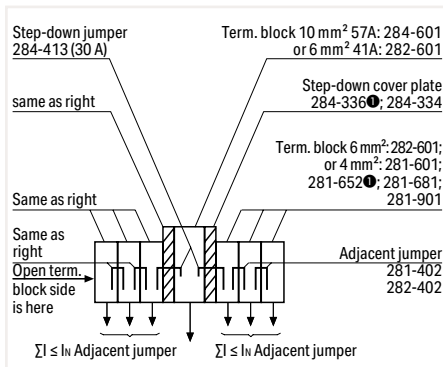

Assembly example: Commoning from 10/6 mm² (8/10 AWG) to 6 mm² (10 AWG) rail-mount terminal blocks via step-down jumper (284-413).

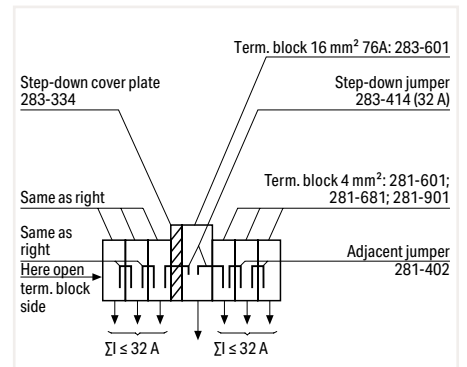

Assembly example: Commoning from 16 mm²/6 AWG to 4 mm²/12 AWG rail-mount terminal blocks via step-down jumper (283-414).

Double-Deck Terminal Block 1.5 mm²; 279 Series

Technical Data	
0.08 ... 1.5 mm ²	28 ... 16 AWG
500 V/6 kV/3 ①	300 V, 10 A ②
I _N 18 A	
Terminal block width: 4 mm / 0.157 inch	
8 ... 9 mm / 0.31 ... 0.35 inch	

Technical Data	
0.08 ... 1.5 mm ²	28 ... 16 AWG
500 V/6 kV/3 ①	300 V, 10 A ②
I _N 18 A	
Terminal block width: 4 mm / 0.157 inch	
8 ... 9 mm / 0.31 ... 0.35 inch	

Technical Data	
0.08 ... 1.5 mm ²	28 ... 16 AWG
500 V/6 kV/3 ①	300 V, 10 A ②
I _N 18 A	
Terminal block width: 4 mm / 0.157 inch	
8 ... 9 mm / 0.31 ... 0.35 inch	

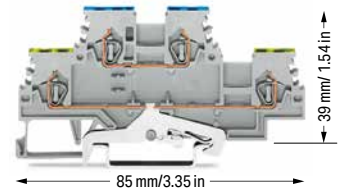
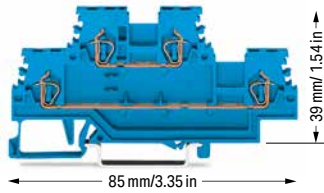
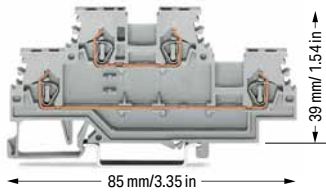

Double-deck terminal block; through/through terminal block; gray		
	Item No.	Pack. Unit
<input type="radio"/> L/L	279-501	50
<input type="radio"/> N/L	279-512	50
<input type="radio"/> L/N	279-513	50

Double-deck terminal block; through/through terminal block; blue		
	Item No.	Pack. Unit
<input checked="" type="radio"/> N/N	279-504 ②	50

Double-deck terminal block; ground conductor/through terminal block; gray		
	Item No.	Pack. Unit
<input type="radio"/> PE/N	279-517	50
<input type="radio"/> PE/L	279-527	50

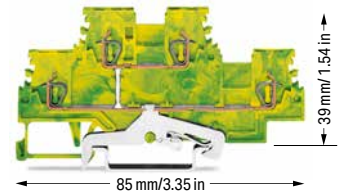
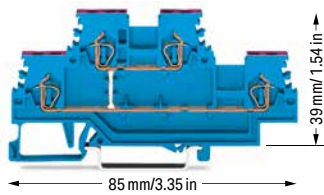
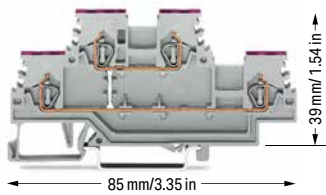

Double-deck terminal block; 4-conductor through terminal block; internally commoned; violet conductor entry; gray		
	Item No.	Pack. Unit
<input type="radio"/> L	279-508	50

Double-deck terminal block; 4-conductor through terminal block; internally commoned; violet conductor entry; blue		
	Item No.	Pack. Unit
<input checked="" type="radio"/> N	279-509 ②	50

Double-deck terminal block; 4-conductor ground terminal block; internally commoned; green-yellow		
	Item No.	Pack. Unit
<input checked="" type="radio"/> PE	279-507	50

6

1 500 V = rated voltage
6 kV = rated impulse voltage
3 = pollution degree
(see Section 15)

2 Terminal blocks with a blue insulated housing are suitable for Ex i applications.

Please observe the application notes:
Insulation stop, page 382
Comb-style jumper bar, page 383
Marking, from page 640

Approvals and corresponding ratings, visit www.wago.com

Accessories; 279 Series

Appropriate marking systems:
WMB/WMB Inline/WFB

End and intermediate plate; 2 mm thick

	orange	279-519	200 (25)
	gray	279-518	

Insulation stop; 0.08 ... 0.2 mm² "s" (0.14 mm² "f-st"); 5 pcs/strip

	white	279-470	200 (25)
---	-------	---------	----------

Insulation stop; 0.25 mm²; 5 pcs/strip

	dark gray	279-471	200 (25)
--	-----------	---------	----------

Protective warning marker; with black high-voltage symbol; for 5 terminal blocks

	yellow	279-415	100 (25)
---	--------	---------	----------

Adjacent jumper; insulated; I_N 15 A

	gray	279-402	200 (25)
	yellow-green	279-422	200 (25)

Alternate jumper; insulated; I_N 15 A

	gray	279-409	100 (25)
---	------	---------	----------

Comb-style jumper bar; insulated; I_N = I_N of terminal block

	2-way	279-482	200 (25)
	3-way	279-483	200 (25)

Comb-style jumper bar; insulated; I_N = I_N of terminal block

	10-way	279-490	50 (25)
---	--------	---------	---------

Alternate comb-style jumper bar; insulated; I_N = I_N of terminal block

	2-way	279-492	200 (25)
---	-------	---------	----------

Operating tool; insulated

	2-way	279-432	1
	3-way	279-433	1

Operating tool; insulated

	10-way	279-440	1
---	--------	---------	---

Accessories; 279 Series

Appropriate marking systems:
WMB/WMB Inline/Marking Strips

Double-deck marker carrier

	gray	279-529	50 (25)
---	------	---------	---------

WMB Inline; plain; 2,000 WMB markers (4 mm)/reel; stretchable 4 ... 4.2 mm

	white	2009-114	1
---	-------	----------	---

WMB marking card; white; 10 strips with 10 markers/card; stretchable 4 ... 4.2 mm

	plain	793-4501	5
---	-------	----------	---

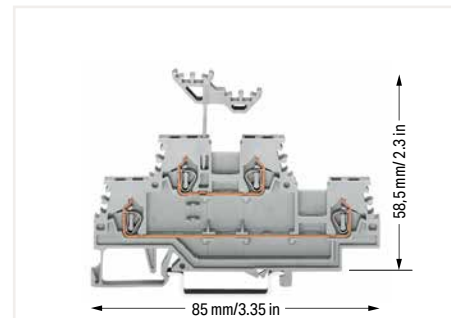

Double-deck marker carrier
(height including marker carrier)

Double- and Triple-Deck Terminal Blocks 280 and 281 Series Description and Installation

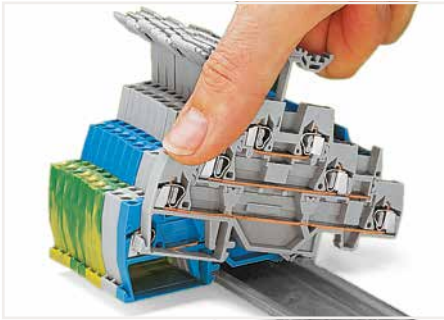

Snapping a terminal block onto the DIN-rail.



Removing a terminal block from the assembly.

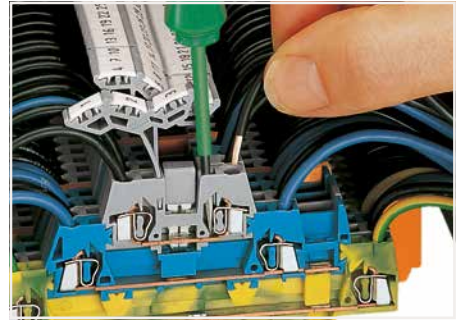

CAGE CLAMP® connection
Inserting a conductor.
With ferruled conductors, it is necessary to use a terminal block one size smaller than the conductor's nominal cross section.

6



Commoning using an adjacent jumper (280-402).
push jumpers down until fully inserted.

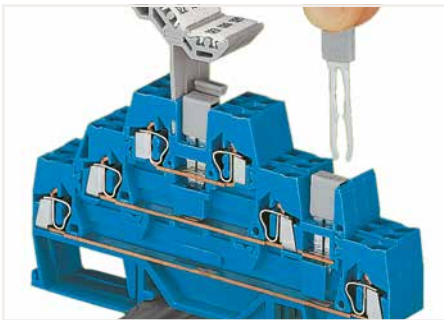

Combining vertical and adjacent jumpers.

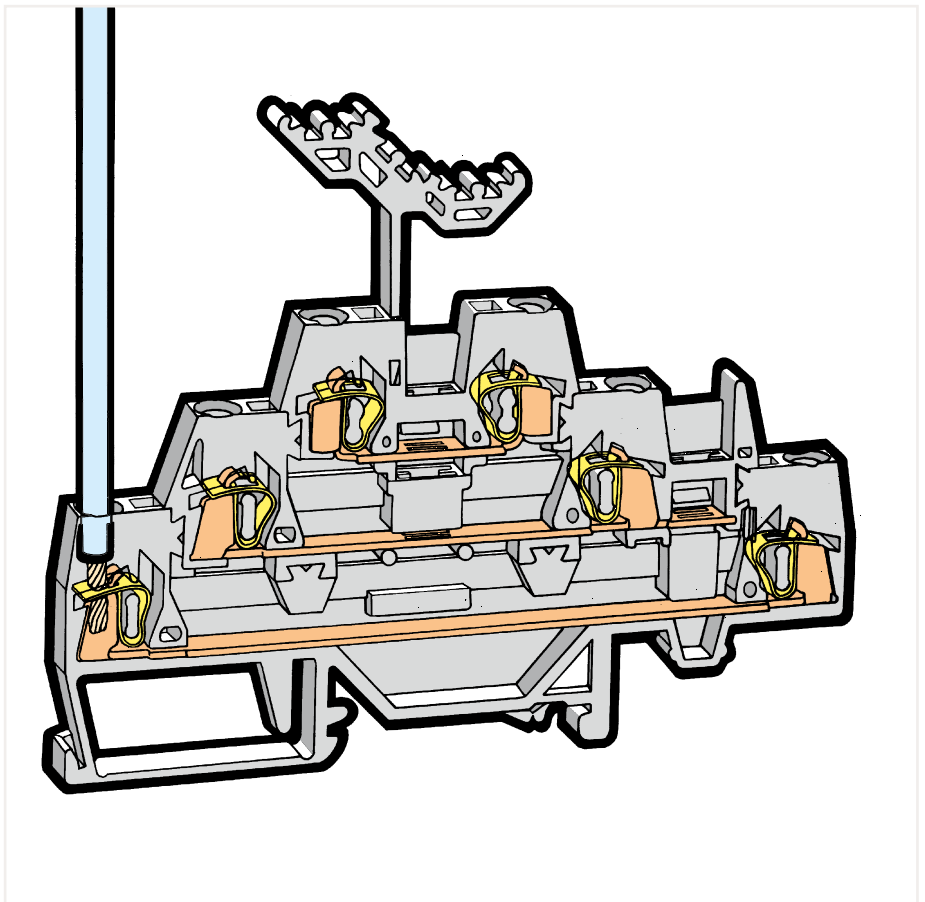

Labeling via WMB Multi Marking System.

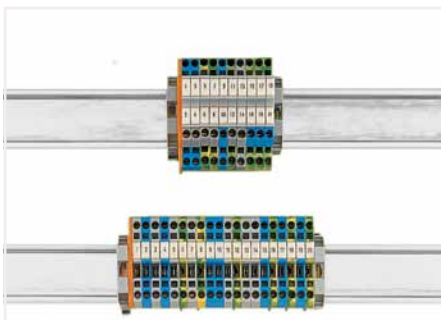

Use 50 % less rail space with double-deck terminal blocks.

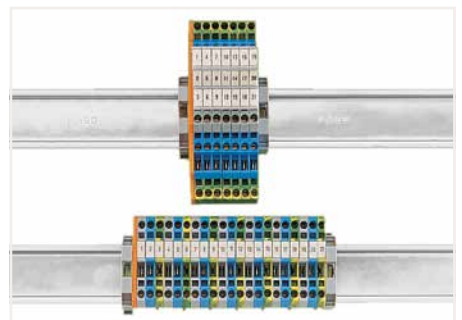

Use 67 % less rail space with triple-deck terminal blocks.



CAGE CLAMP® terminates the following copper conductors:
solid "s"



stranded "st"



fine-stranded "f-st",
also with tinned
single strands

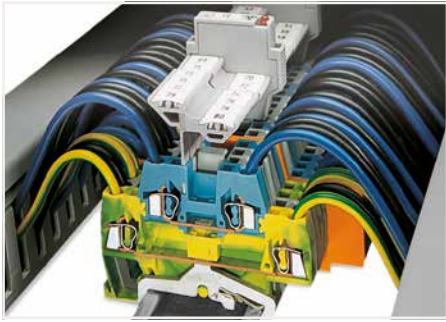

Example of a mixed assembly with double-deck terminal blocks. The 280 Series Double-Deck Terminal Blocks are available with decks of same or different color according to their function. This is an additional visual aid during wiring, service or maintenance.

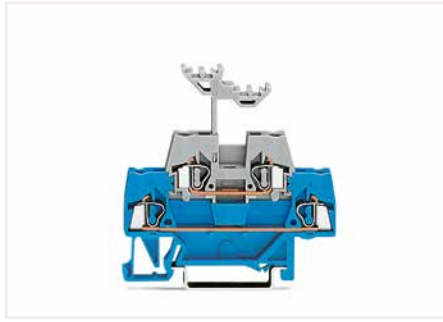

Double-deck terminal blocks accommodate two circuits of different potentials on two decks; different circuits can be differentiated by color coding either deck (280 Series). The lower deck is wider than the upper for ease of wiring.

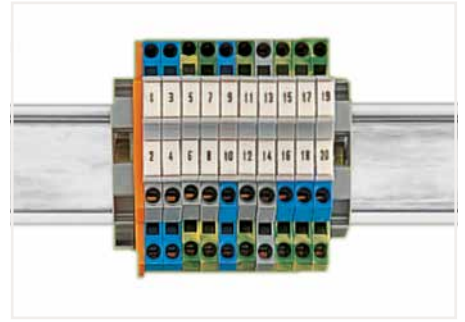

With a terminal block width of just 5 mm, an effective width of just 2.5 mm for terminal blocks of same or different potentials can be realized for conductors ranging 0.08 mm² ... 2.5 mm² (28 ... 14 AWG).

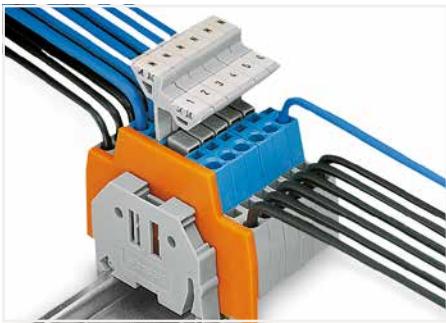

Double-deck terminal blocks used as control conductor terminal blocks (e.g., for magnetic valves) with the upper deck commoned.

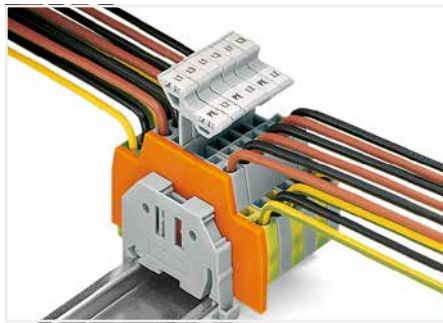

Double-deck terminal blocks used for connecting a three-phase motor.

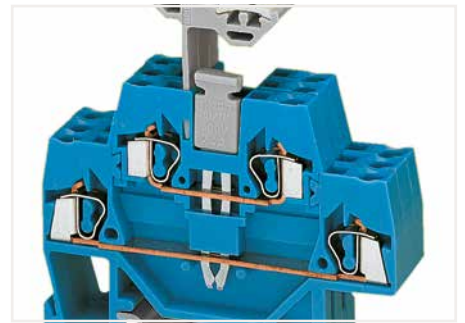

Commoning with a vertical jumper (281-421). Push vertical jumper down until fully inserted.

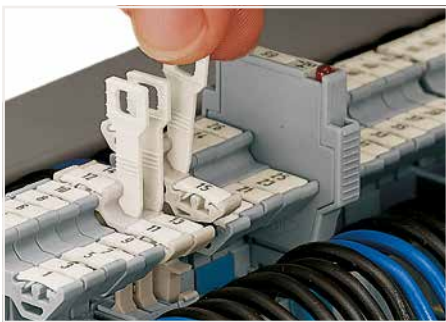

Pulling the disconnect tab.

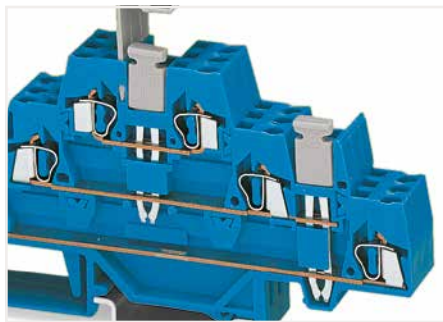

A vertical jumper allows commoning of the upper and lower levels, providing a 6-conductor feedthrough terminal block in one housing. Two adjacent triple-deck terminal blocks may be commoned together on the same level using a push-in adjacent jumper.

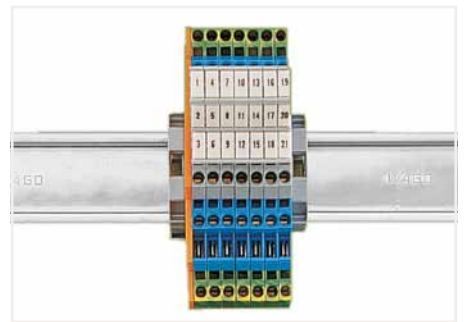

Double-deck (triple-deck) terminal blocks accommodate two (three) circuits of different potentials on two (three) decks; different circuits can be differentiated by color coding either deck (280 Series). The lower deck is wider than the upper for ease of wiring.

6



fine-stranded, tip-bonded



fine-stranded, with ferrule (gastight crimped)



fine-stranded, with pin terminal (gastight crimped)

Double-Deck Terminal Block

2.5 mm²; 280 Series

Technical Data	
0.08 ... 2.5 mm ²	28 ... 12 AWG*
500 V/6 kV/3 ①	300 V, 15 A ②
I _N 20 A	300 V, 20 A ③
Terminal block width: 5 mm / 0.197 inch	
8 ... 9 mm / 0.31 ... 0.35 inch	

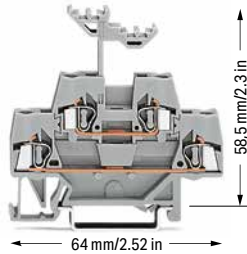

Double-deck terminal block; through/through terminal block

Color	Item No.	Pack. Unit
○ gray	280-519	50
● blue	280-529 ②	50

Other terminal blocks with the same profile:

Diode	280-940/281-410	Page 370
LED	280-943/281-434	Page 370

Accessories; item-specific

End and intermediate plate; 2.5 mm thick

orange	280-341	100 (25)
gray	280-340	100 (25)

Intermediate plate; 1.1 mm thick

orange	280-366	100 (25)
--------	---------	----------

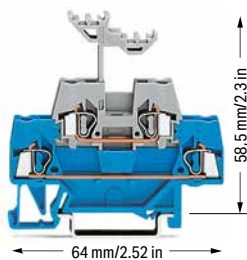

Double-deck terminal block; through/through terminal block

Color	Item No.	Pack. Unit
blue/gray	280-523	50
gray/blue	280-533	50

Accessories; item-specific

End and intermediate plate; 2.5 mm thick

orange	280-341	100 (25)
gray	280-340	100 (25)

Intermediate plate; 1.1 mm thick

orange	280-366	100 (25)
--------	---------	----------

Technical Data	
0.08 ... 2.5 mm ²	28 ... 12 AWG*
500 V/6 kV/3 ①	300 V, 15 A ②
I _N 20 A	300 V, 20 A ③
Terminal block width: 5 mm / 0.197 inch	
8 ... 9 mm / 0.31 ... 0.35 inch	

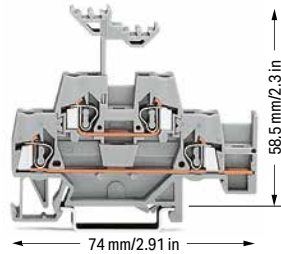

Double-deck terminal block; through/through terminal block; with slot for adjacent jumper

Color	Item No.	Pack. Unit
○ gray	280-520	50
● blue	280-530 ②	50

Accessories; item-specific

End and intermediate plate; 2.5 mm thick

orange	280-343	100 (25)
gray	280-342	100 (25)

Intermediate plate; 1.1 mm thick

orange	280-369	100 (25)
--------	---------	----------

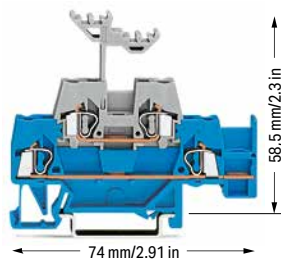

Double-deck terminal block; through/through terminal block; with slot for adjacent jumper

Color	Item No.	Pack. Unit
blue/gray	280-524	50
gray/blue	280-534	50

Accessories; item-specific

End and intermediate plate; 2.5 mm thick

orange	280-343	100 (25)
gray	280-342	100 (25)

Intermediate plate; 1.1 mm thick

orange	280-369	100 (25)
--------	---------	----------

Technical Data	
0.08 ... 2.5 mm ²	28 ... 12 AWG*
500 V/6 kV/3 ①	300 V, 20 A ③
I _N 20 A	300 V, 20 A ③
Terminal block width: 5 mm / 0.197 inch	
8 ... 9 mm / 0.31 ... 0.35 inch	

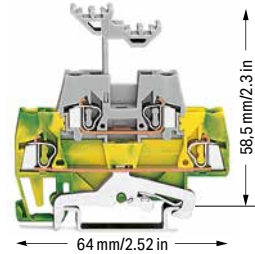

Double-deck terminal block; ground conductor/through terminal block

Color	Item No.	Pack. Unit
green-yellow/gray	280-527	50
green-yellow/blue	280-537	50

Accessories; item-specific

End and intermediate plate; 2.5 mm thick

orange	280-341	100 (25)
gray	280-340	100 (25)

Intermediate plate; 1.1 mm thick

orange	280-366	100 (25)
--------	---------	----------

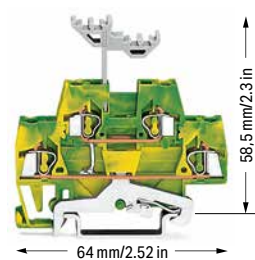

Double-deck terminal block; 4-conductor ground terminal block; internally commoned

Color	Item No.	Pack. Unit
● green-yellow	280-517	50

Accessories; item-specific

End and intermediate plate; 2.5 mm thick

orange	280-341	100 (25)
gray	280-340	100 (25)

Intermediate plate; 1.1 mm thick

orange	280-366	100 (25)
--------	---------	----------

6

Technical Data	
0.08 ... 2.5 mm ²	28 ... 12 AWG*
400 V/6 kV/3 ①	300 V, 15 A ②
I _N 10 A	300 V, 20 A ③
Terminal block width: 5 mm / 0.197 inch	
8 ... 9 mm / 0.31 ... 0.35 inch	

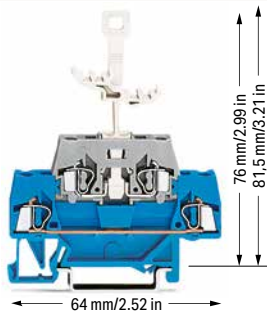

Double-deck terminal block; through/disconnect terminal block

Color	Item No.	Pack. Unit
blue/gray	280-525	50
○ gray/gray	280-521	50

Accessories; item-specific			
End and intermediate plate; 2.5 mm thick			
	orange	280-341	100 (25)
	gray	280-340	100 (25)

Accessories; item-specific			
Intermediate plate; 1.1 mm thick			
	orange	280-366	100 (25)

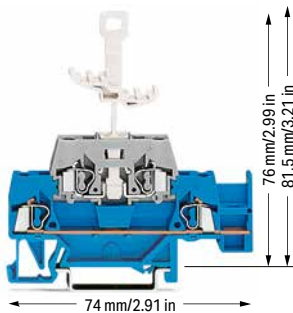

Double-deck terminal block; through/disconnect terminal block; with slot for adjacent jumper

Color	Item No.	Pack. Unit
blue/gray	280-526	50
○ gray/gray	280-522	50

Accessories; item-specific			
End and intermediate plate; 2.5 mm thick			
	orange	280-343	100 (25)
	gray	280-342	100 (25)

Accessories; item-specific			
Intermediate plate; 1.1 mm thick			
	orange	280-369	100 (25)

Technical Data	
0.08 ... 2.5 mm ²	28 ... 12 AWG*
500 V/6 kV/3 ①	300 V, 15 A ②
I _N 20 A	300 V, 20 A ③
Terminal block width: 5 mm / 0.197 inch	
8 ... 9 mm / 0.31 ... 0.35 inch	

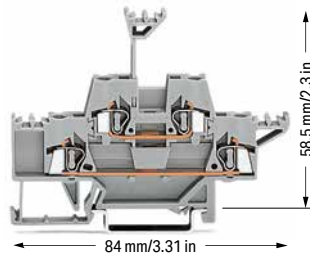

Double-deck terminal block; through/through terminal block; with additional marking options on both terminal block sides

Color	Item No.	Pack. Unit
○ gray	280-513	50

Accessories; item-specific			
End and intermediate plate; 2.5 mm thick			
	orange	280-341	100 (25)
	gray	280-340	100 (25)

Accessories; item-specific			
Intermediate plate; 1.1 mm thick			
	orange	280-366	100 (25)

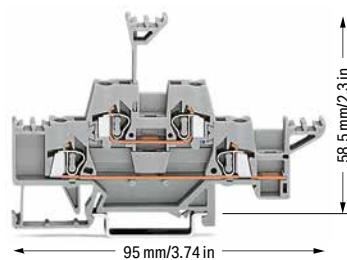

Double-deck terminal block; through/through terminal block; with additional marking options on both terminal block sides; with slot for adjacent jumper

Color	Item No.	Pack. Unit
○ gray	280-543	50

Accessories; item-specific			
End and intermediate plate; 2.5 mm thick			
	orange	280-343	100 (25)
	gray	280-342	100 (25)

Accessories; item-specific			
Intermediate plate; 1.1 mm thick			
	orange	280-369	100 (25)

*12 AWG: THHN, THWN

① 500 V / 400 V = rated voltage
6 kV = rated impulse voltage
3 = pollution degree
(see Section 15)

② Terminal blocks with a blue insulated housing are suitable for Ex i applications.

Please observe the application notes:
Insulation stop, page 382
Comb-style jumper bar, page 383
Marking, from page 640

Approvals and corresponding ratings, visit www.wago.com

Accessories; 280 Series

Appropriate marking systems:
WMB/WMB Inline

Insulation stop; 0.08 ... 0.2 mm² "s" (0.14 mm² "f-st"); 5 pcs/strip

	white	280-470	200 (25)
--	-------	---------	----------

Insulation stop; 0.25 ... 0.5 mm²; 5 pcs/strip

	light gray	280-471	200 (25)
--	------------	---------	----------

Insulation stop; 0.75 ... 1 mm²; 5 pcs/strip

	dark gray	280-472	200 (25)
--	-----------	---------	----------

Adjacent jumper; insulated; I_N = I_N terminal block

	gray	280-402	200 (25)
	yellow-green	280-422	200 (25)

Alternate jumper; insulated; I_N = I_N terminal block

	gray	280-409	100 (25)
--	------	---------	----------

Vertical jumper; insulated; I_N 24 A

	gray	281-421	200 (25)
--	------	---------	----------

Comb-style jumper bar; insulated; I_N = I_N of terminal block

	2-way	280-482	200 (25)
	3-way	280-483	200 (25)

Comb-style jumper bar; insulated; I_N = I_N of terminal block

	10-way	280-490	50 (25)
--	--------	---------	---------

Alternate comb-style jumper bar; insulated; I_N = I_N of terminal block

	2-way	280-492	200 (25)
--	-------	---------	----------

Operating tool; insulated

	2-way	280-432	1
	3-way	280-433	1

Operating tool; insulated

	10-way	280-440	1
--	--------	---------	---

Double- and Triple-Deck Carrier Terminal Block for Fuse Plugs 2.5 mm²; 280 Series

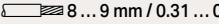
Technical Data	
0.08 ... 2.5 mm ²	28 ... 12 AWG*
400 V/6 kV/3 1 2	300 V, 15 A 1 2
I _N 10 A (20 A)	300 V, 20 A 2
Terminal block width: 5 mm / 0.197 inch	
 8 ... 9 mm / 0.31 ... 0.35 inch	

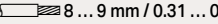
Technical Data	
0.08 ... 2.5 mm ²	28 ... 12 AWG*
400 V/6 kV/3 1 2	300 V, 15 A 1 2
I _N 10 A (20 A)	300 V, 20 A 2
Terminal block width: 5 mm / 0.197 inch	
 8 ... 9 mm / 0.31 ... 0.35 inch	

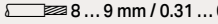
Technical Data	
0.08 ... 2.5 mm ²	28 ... 12 AWG*
400 V/6 kV/3 1 2	300 V, 15 A 1 2
I _N 10 A (10 A)	
Terminal block width: 5 mm / 0.197 inch	
 8 ... 9 mm / 0.31 ... 0.35 inch	

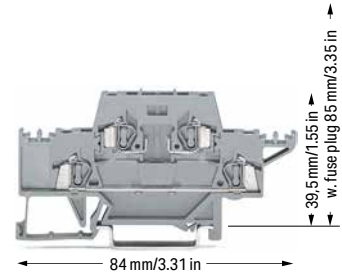
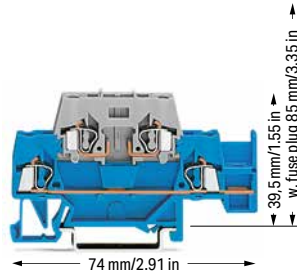
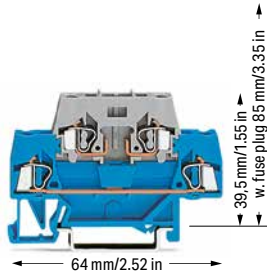

Double-deck terminal block; through/carrier terminal block for fuse plugs

Color	Item No.	Pack. Unit
blue/gray	280-531	50
○ gray/gray	280-514	50



Double-deck terminal block; through/carrier terminal block for fuse plugs; with slot for adjacent jumper

Color	Item No.	Pack. Unit
blue/gray	280-532	50
○ gray/gray	280-891	50



Double-deck terminal block; through/carrier terminal block for fuse plugs

Color	Item No.	Pack. Unit
○ gray/gray	280-528	50

Accessories; item-specific
End and intermediate plate; 2.5 mm thick

 orange	280-341	100 (25)
 gray	280-340	100 (25)

Accessories; item-specific
End and intermediate plate; 2.5 mm thick

 orange	280-343	100 (25)
 gray	280-342	100 (25)

Accessories; item-specific
End and intermediate plate; 2.5 mm thick

 orange	280-341	100 (25)
 gray	280-340	100 (25)

Intermediate plate; 1.1 mm thick

 orange	280-366	100 (25)
--	---------	----------

Intermediate plate; 1.1 mm thick

 orange	280-369	100 (25)
--	---------	----------

Intermediate plate; 1.1 mm thick

 orange	280-366	100 (25)
--	---------	----------

Adjacent jumper; insulated; I_N = I_N terminal block

 gray	280-402	200 (25)
--	---------	----------

Alternate jumper; insulated; I_N = I_N terminal block

 gray	280-409	100 (25)
--	---------	----------

Accessories

Appropriate marking systems: 4 mm wide WSB for plug and WMB terminal block

Insulation stop; 0.08 ... 0.2 mm² "s" (0.14 mm² "f-st"); 5 pcs/strip

 white	280-470	200 (25)
---	---------	----------

Fuse plug with pull-tab; 6 mm wide

	281-512	50
---	---------	----

Operating tool; insulated

 2-way	280-432	1
3-way	280-433	1

Insulation stop; 0.25 ... 0.5 mm²; 5 pcs/strip

 light gray	280-471	200 (25)
--	---------	----------

Fuse plug with pull-tab; 24 VAC/DC; with LED; 6 mm wide

	281-512/281-501	50
---	-----------------	----

WMB marking card; white; 10 strips with 10 markers/card; 4 ... 4.2 mm stretchable

 plain	793-4501	5
---	----------	---

Insulation stop; 0.75 ... 1 mm²; 5 pcs/strip

 dark gray	280-472	200 (25)
---	---------	----------

Comb-style jumper bar; insulated; I_N = I_N of terminal block

 2-way	280-482	200 (25)
3-way	280-483	200 (25)

WMB marking card; white; 10 strips with 10 markers/card; 4 ... 4.2 mm stretchable

 F1, ..., F10 (10x)	794-4615	5
F11, ..., F20 (10x)	794-4616	5
F21, ..., F30 (10x)	794-4617	5
F31, ..., F40 (10x)	794-4618	5
F41, ..., F50 (10x)	794-4619	5

Fuse plug with pull-tab; 6 mm wide

	281-511	50
---	---------	----

Alternate comb-style jumper bar; insulated; I_N = I_N of terminal block

 2-way	280-492	200 (25)
---	---------	----------

Technical Data	
0.08 ... 2.5 mm ²	28 ... 12 AWG*
400 V/6 kV/3 ①②	300 V, 15 A ③
I _N 20 A (20 A)	300 V, 20 A ④
Terminal block width: 5 mm / 0.197 inch	
8 ... 9 mm / 0.31 ... 0.35 inch	

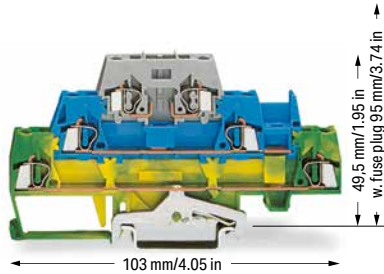

Triple-deck terminal block; ground conductor/through/carrier terminal block for fuse plugs

Color	Item No.	Pack. Unit
green-yellow/blue/gray	280-510	50

Technical Data	
0.08 ... 2.5 mm ²	28 ... 12 AWG*
400 V/6 kV/3 ①②	300 V, 15 A ③
I _N 20 A (20 A)	300 V, 20 A ④
Terminal block width: 5 mm / 0.197 inch	
8 ... 9 mm / 0.31 ... 0.35 inch	

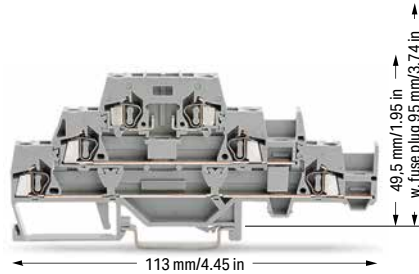

Triple-deck terminal block; through/through/carrier terminal block for fuse plugs; with slot for adjacent jumper on lower level

Color	Item No.	Pack. Unit
gray/gray/gray	280-889	50

Accessories; item-specific
End and intermediate plate; 2.5 mm thick

	orange	280-304	50 (25)
	gray	280-303	50 (25)

Intermediate plate; 1.1 mm thick

	orange	280-336	50 (25)
--	--------	---------	---------

Adjacent jumper; insulated; I_N = I_N terminal block

	gray	280-402	200 (25)
--	------	---------	----------

Alternate jumper; insulated; I_N = I_N terminal block

	gray	280-409	100 (25)
--	------	---------	----------

Vertical jumper; insulated; I_N 24 A

	gray	281-421	200 (25)
--	------	---------	----------

WSB marking card; white, 10 strips with 10 markers/card; 4 mm wide WSB markers

	plain	209-701	5
--	-------	---------	---

WSB marking card; plain; 10 strips with 10 markers/card; 4 mm wide WSB markers

	yellow	209-701/000-002	5
	red	209-701/000-005	5
	blue	209-701/000-006	5
	gray	209-701/000-007	5
	orange	209-701/000-012	5
	light green	209-701/000-017	5
	green	209-701/000-023	5
	violet	209-701/000-024	5

Accessories; item-specific
End and intermediate plate; 2.5 mm thick

	orange	280-306	50 (25)
	gray	280-305	50 (25)

Intermediate plate; 1.1 mm thick

	orange	280-339	50 (25)
--	--------	---------	---------

Adjacent jumper; insulated; I_N = I_N terminal block

	gray	280-402	200 (25)
--	------	---------	----------

Alternate jumper; insulated; I_N = I_N terminal block

	gray	280-409	100 (25)
--	------	---------	----------

Vertical jumper; insulated; I_N 24 A

	gray	281-421	200 (25)
--	------	---------	----------

WSB marking card; for fuse plugs (281-5...); white; 4 mm wide WSB markers

	F1, ..., F10 (10x)	209-787	5
	F11, ..., F20 (10x)	209-700/209-124	5
	F21, ..., F30 (10x)	209-700/209-125	5
	F31, ..., F40 (10x)	209-700/209-126	5
	F41, ..., F50 (10x)	209-700/209-127	5

*12 AWG: THHN, THWN

- 500 V / 400 V = rated voltage
6 kV = rated impulse voltage
3 = pollution degree
(see Section 15)

- Electrical ratings are given by the fuse or LED nominal voltage (see page 344).

Please observe the application notes:
Insulation stop, page 382
Comb-style jumper bar, page 383
Marking, from page 640

Approvals and corresponding ratings, visit www.wago.com

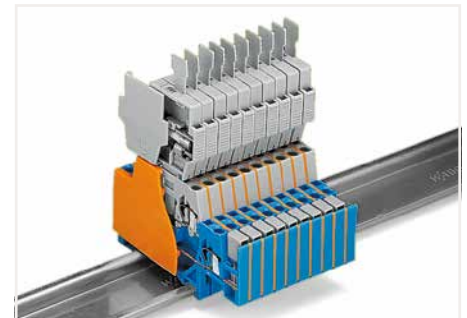

When double-deck terminal blocks are used with a fuse plug (6 mm wide) in the receptacle (top) level, the extra width can be compensated for the 280 Series (5 mm wide) via an intermediate plate (1.1 mm thick). If required, this special intermediate plate still allows commoning on the lower level via push-in adjacent jumpers (280-402).

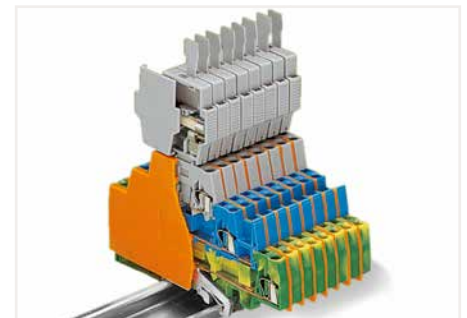

When triple-deck terminal blocks are used with a fuse plug (6 mm wide) in the receptacle (top) level, the extra width can be compensated for the 280 Series (5 mm wide) via an intermediate plate (1.1 mm thick).

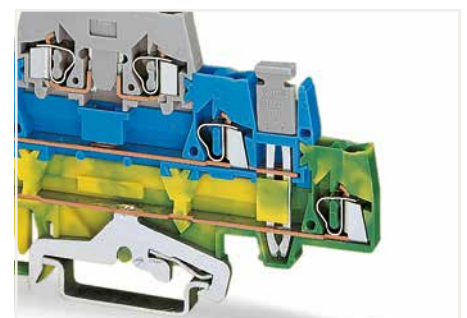

Grounding to DIN-rail:
Connecting N-level to ground level via vertical jumper.

Double-Deck Terminal Block

4 mm²; 281 Series

Technical Data

0.08 ... 4 mm ²	28 ... 12 AWG
500 V/6 kV/3 ①	600 V, 20 A ②
I _N 26 A	600 V, 25 A ②

Terminal block width: 6 mm / 0.236 inch

9 ... 10 mm / 0.35 ... 0.39 inch

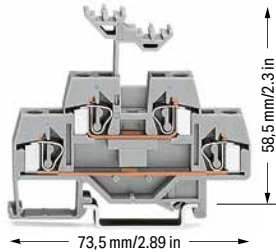

Technical Data

0.08 ... 4 mm ²	28 ... 12 AWG
500 V/6 kV/3 ①	600 V, 20 A ②
I _N 26 A	600 V, 25 A ②

Terminal block width: 6 mm / 0.236 inch

9 ... 10 mm / 0.35 ... 0.39 inch

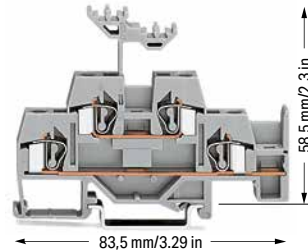

Double-deck terminal block; through/through terminal block

Color	Item No.	Pack. Unit
○ gray	281-619	50
● blue	281-629 ②	50

Other terminal blocks with the same profile:

Diode	281-633/281-410	Page 372
LED	281-634/281-434	Page 372

Accessories; item-specific

End and intermediate plate; 2.5 mm thick

	orange	281-341	100 (25)
	gray	281-340	100 (25)

Double-deck terminal block; through/through terminal block; with slot for adjacent jumper

Color	Item No.	Pack. Unit
○ gray	281-620	50
● blue	281-630 ②	50

Accessories; item-specific

End and intermediate plate; 2.5 mm thick

	orange	281-343	100 (25)
	gray	281-342	100 (25)

Accessories; 281 Series

Appropriate marking systems: WMB/WMB Inline

Insulation stop; 0.08 ... 0.2 mm² "s" (0.14 mm² "f-st"); 5 pcs/strip

	white	281-470	200 (25)
--	-------	---------	----------

Insulation stop; 0.25 ... 0.5 mm²; 5 pcs/strip

	light gray	281-471	200 (25)
--	------------	---------	----------

Insulation stop; 0.75 ... 1.5 mm²; 5 pcs/strip

	dark gray	281-472	200 (25)
--	-----------	---------	----------

Adjacent jumper; insulated; I_N = I_N terminal block

	gray	281-402	200 (25)
	yellow-green	281-422	200 (25)

Alternate jumper; insulated; I_N = I_N terminal block

	gray	281-409	100 (25)
--	------	---------	----------

Vertical jumper; insulated; I_N 24 A

	gray	281-421	200 (25)
--	------	---------	----------

Comb-style jumper bar; insulated; I_N = I_N of terminal block

	2-way	281-482	100 (25)
	3-way	281-483	100 (25)
	5-way	281-485	100 (25)
	10-way	281-490	50 (25)

- ① 500 V = rated voltage
6 kV = rated impulse voltage
3 = pollution degree
(see Section 15)

- ② Terminal blocks with a blue insulated housing are suitable for Ex i applications.

Please observe the application notes:
Insulation stop, page 382
Comb-style jumper bar, page 383
Marking, from page 640

Approvals and corresponding ratings,
visit www.wago.com



The flexible marker carrier, which is placed above the wiring level, can be pushed aside during wiring or commoning. The carrier has two staggered levels for WMB markers that perfectly align with the terminal block decks.

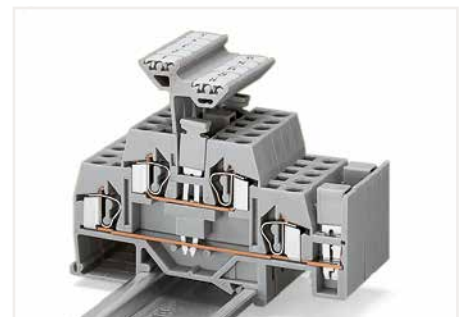

A vertical jumper allows commoning of upper and lower level, giving a 4-conductor commoned through terminal block in one housing. Two adjacent terminals may be commoned together on the same level using a push-in adjacent jumper.

6

Triple-Deck Terminal Block 2.5 mm²; 280 Series

Technical Data

0.08 ... 2.5 mm ²	28 ... 12 AWG*
500 V/6 kV/3 ①	300 V, 15 A ②
I _N 20 A	300 V, 20 A ③

Terminal block width: 5 mm / 0.197 inch

8 ... 9 mm / 0.31 ... 0.35 inch

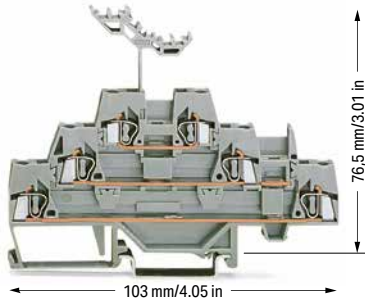



Triple-deck terminal block; through/through/through terminal block

Color	Item No.	Pack. Unit
○ gray	280-549	40
● blue	280-551	40

Accessories; item-specific

End and intermediate plate; 2.5 mm thick

 orange	280-304	50 (25)
 gray	280-303	50 (25)

Intermediate plate; 1.1 mm thick

 orange	280-336	50 (25)
---	---------	---------

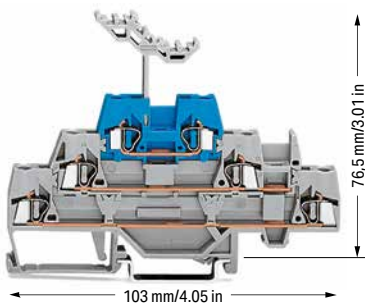

Triple-deck terminal block; through/through/through terminal block

Color	Item No.	Pack. Unit
gray/gray/blue	280-552	40

Accessories; item-specific

End and intermediate plate; 2.5 mm thick

 orange	280-304	50 (25)
 gray	280-303	50 (25)

Intermediate plate; 1.1 mm thick

 orange	280-336	50 (25)
---	---------	---------

Technical Data

0.08 ... 2.5 mm ²	28 ... 12 AWG*
500 V/6 kV/3 ①	300 V, 15 A ②
I _N 20 A	300 V, 20 A ③

Terminal block width: 5 mm / 0.197 inch

8 ... 9 mm / 0.31 ... 0.35 inch

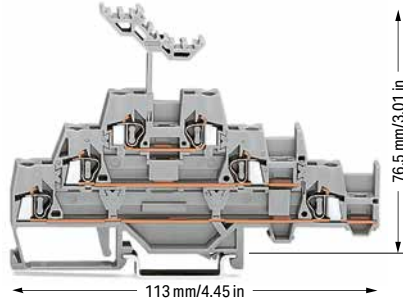



Triple-deck terminal block; through/through/through terminal block; with slot for adjacent jumper on lower level

Color	Item No.	Pack. Unit
○ gray	280-550	40

Accessories; item-specific

End and intermediate plate; 2.5 mm thick

 orange	280-306	50 (25)
 gray	280-305	50 (25)

Intermediate plate; 1.1 mm thick

 orange	280-339	50 (25)
--	---------	---------

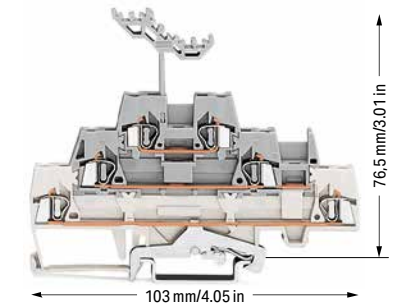

Triple-deck terminal block; shield conductor/through/through terminal block

Color	Item No.	Pack. Unit
white/gray/gray	280-548	40
white/blue/gray	280-558	40

Accessories; item-specific

End and intermediate plate; 2.5 mm thick

 orange	280-304	50 (25)
 gray	280-303	50 (25)

Intermediate plate; 1.1 mm thick

 orange	280-336	50 (25)
--	---------	---------

Technical Data

0.08 ... 2.5 mm ²	28 ... 12 AWG*
500 V/6 kV/3 ①	300 V, 20 A ③
I _N 20 A	

Terminal block width: 5 mm / 0.197 inch

8 ... 9 mm / 0.31 ... 0.35 inch

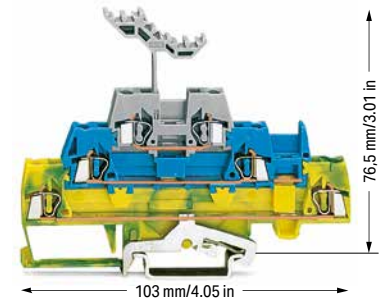

Triple-deck terminal block; ground conductor/through/through terminal block

Color	Item No.	Pack. Unit
green-yellow/blue/gray	280-547	40
green-yellow/gray/gray	280-557	40

Accessories; item-specific

End and intermediate plate; 2.5 mm thick

 orange	280-304	50 (25)
 gray	280-303	50 (25)

Intermediate plate; 1.1 mm thick

 orange	280-336	50 (25)
--	---------	---------

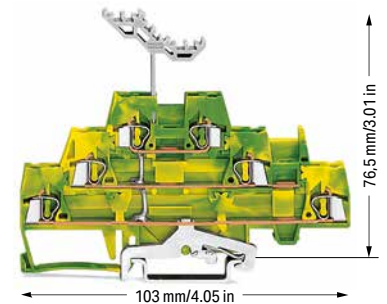

Triple-deck terminal block; 6-conductor ground terminal block; internally commoned

Color	Item No.	Pack. Unit
● green-yellow	280-597	40

Accessories; item-specific

End and intermediate plate; 2.5 mm thick

 orange	280-304	50 (25)
 gray	280-303	50 (25)

Intermediate plate; 1.1 mm thick

 orange	280-336	50 (25)
--	---------	---------

6

*12 AWG: THHN, THWN

- ① 500 V = rated voltage
- 6 kV = rated impulse voltage
- 3 = pollution degree (see Section 15)

Please observe the application notes:
 Insulation stop, page 382
 Comb-style jumper bar, page 383
 Marking, from page 640

Approvals and corresponding ratings, visit www.wago.com

Accessories; 280 Series

Appropriate marking systems:
 WMB/WMB Inline

Insulation stop; 0.08 ... 0.2 mm² "s" (0.14 mm² "f-st"); 5 pcs/strip

	white	280-470	200 (25)
---	-------	---------	----------

Insulation stop; 0.25 ... 0.5 mm²; 5 pcs/strip

	light gray	280-471	200 (25)
---	------------	---------	----------

Insulation stop; 0.75 ... 1 mm²; 5 pcs/strip

	dark gray	280-472	200 (25)
---	-----------	---------	----------

Adjacent jumper; insulated; I_N = I_N terminal block

	gray	280-402	200 (25)
	yellow-green	280-422	200 (25)

Alternate jumper; insulated; I_N = I_N terminal block

	gray	280-409	100 (25)
---	------	---------	----------

Vertical jumper; insulated; I_N 24 A

	gray	281-421	200 (25)
---	------	---------	----------

Comb-style jumper bar; insulated; I_N = I_N of terminal block

	2-way	280-482	200 (25)
	3-way	280-483	200 (25)

Comb-style jumper bar; insulated; I_N = I_N of terminal block

	10-way	280-490	50 (25)
---	--------	---------	---------

Alternate comb-style jumper bar; insulated; I_N = I_N of terminal block

	2-way	280-492	200 (25)
---	-------	---------	----------

Operating tool; insulated

	2-way	280-432	1
	3-way	280-433	1

Operating tool; insulated

	10-way	280-440	1
---	--------	---------	---

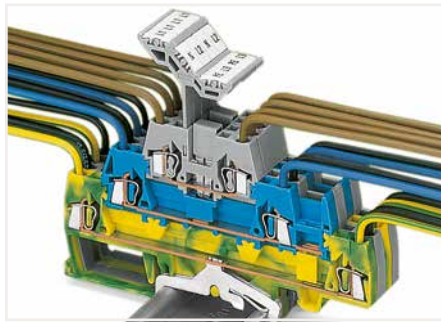

Three-conductor power circuit with additional branch circuit tapping

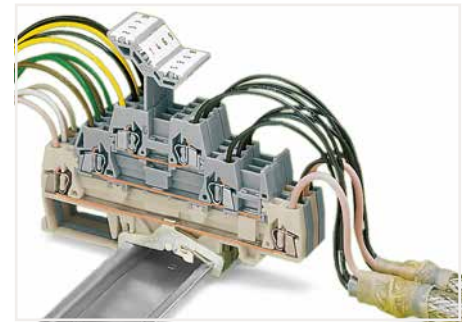

Shielded twisted pair cables

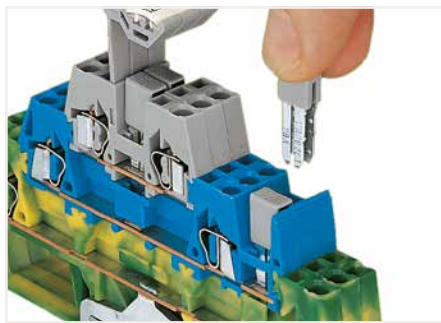

Triple-deck terminal blocks accommodate three circuits of different potentials on three decks; different circuits can be differentiated by color coding either deck (280 Series).

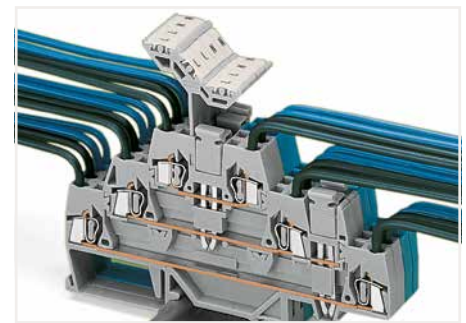

Commoning with vertical and adjacent jumpers.

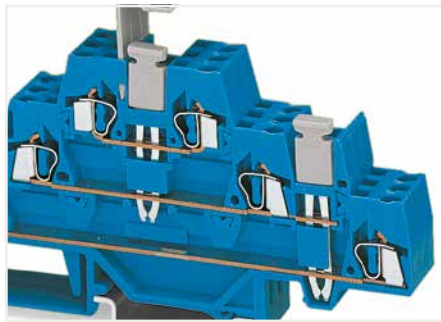

A vertical jumper allows commoning of the upper and lower levels, providing a 6-conductor feedthrough terminal block in one housing. Two adjacent triple-deck terminal blocks may be commoned together on the same level using a push-in adjacent jumper.



Both ground and shield conductor terminal blocks have a contact foot in the bottom level, automatically establishing direct contact to the DIN-rail or busbar. The flexible marker carrier, which is placed above the wiring level, can be pushed aside during wiring. The carrier has two staggered levels for WMB markers that perfectly align with the terminal block decks. With a terminal block width of just 5 mm, an effective width of just 1.67 mm for terminal blocks of same or different potentials can be realized for conductors ranging 0.08 mm² ... 2.5 mm² (28 ... 14 AWG).

Quadruple-Deck Rail-Mount Terminal Block for Electric Motor Wiring 4 mm²; 281 Series

Technical Data	
0.08 ... 4 mm ²	28 ... 12 AWG
400 V/6 kV/3 ①	600 V, 20 A, $\sqrt{3}$
I _N 20 A (2.5 mm ²)	300 V, 25 A ②
I _N 25 A (4 mm ²)	
Terminal block width: 6 mm / 0.236 inch	
8 ... 9 mm / 0.31 ... 0.35 inch	

Technical Data	
0.08 ... 4 mm ²	28 ... 12 AWG
400 V/6 kV/3 ①	600 V, 20 A, $\sqrt{3}$
I _N 20 A (2.5 mm ²)	300 V, 25 A ②
I _N 25 A (4 mm ²)	
Terminal block width: 6 mm / 0.236 inch	
8 ... 9 mm / 0.31 ... 0.35 inch	

Technical Data	
0.08 ... 4 mm ²	28 ... 12 AWG
400 V/6 kV/3 ①	600 V, 20 A, $\sqrt{3}$
I _N 20 A (2.5 mm ²)	300 V, 25 A ②
I _N 25 A (4 mm ²)	
Terminal block width: 6 mm / 0.236 inch	
8 ... 9 mm / 0.31 ... 0.35 inch	

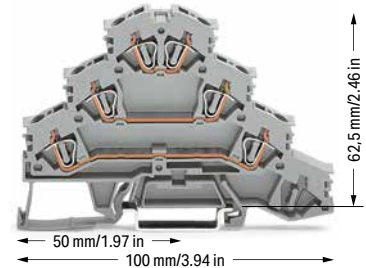
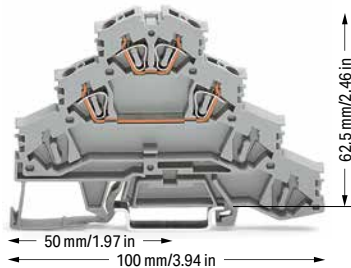
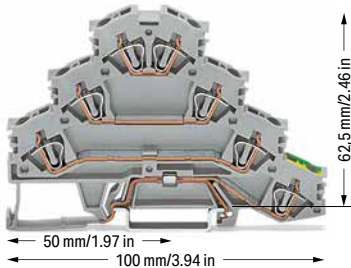

Quadruple-deck rail-mount terminal block; Rail-mount terminal block for electric motor wiring; gray		
	Item No.	Pack. Unit
○ L1 - L2 - L3 - PE	281-530	50

Quadruple-deck rail-mount terminal block; Rail-mount terminal block for electric motor wiring; gray		
	Item No.	Pack. Unit
○ L1 - L2	281-531	50

Quadruple-deck rail-mount terminal block; Rail-mount terminal block for electric motor wiring; gray		
	Item No.	Pack. Unit
○ L1 - L2 - L3	281-532	50

6

Accessories; 281 Series

End and intermediate plate; 1 mm thick			
	orange	281-366	100 (25)
	gray	281-365	100 (25)

	white	281-470	200 (25)
---	-------	---------	----------

Insulation stop; 0.25 ... 0.5 mm ² ; 5 pcs/strip			
	light gray	281-471	200 (25)

Insulation stop; 0.75 ... 1.5 mm ² ; 5 pcs/strip			
	dark gray	281-472	200 (25)

Comb-style jumper bar; insulated; I _N = I _N of terminal block			
	2-way	281-482	100 (25)
	3-way	281-483	100 (25)
	5-way	281-485	100 (25)
	10-way	281-490	50 (25)

Alternate comb-style jumper bar; insulated; I _N = I _N of terminal block			
	2-way	281-492	100 (25)

Operating tool; insulated			
	2-way	280-432	1
	3-way	280-433	1
	5-way	281-440	1

Test plug; with 500 mm cable; 2 mm Ø; max. 42 V			
	red	210-136	50

Appropriate marking systems: WMB/Marking strips

Marking strip; plain; 7.5 mm wide; 50 m reel			
	translucent	709-177	1

WMB marking card; white; 10 strips with 10 markers/card; stretchable 5 ... 5.2 mm			
	plain	793-5501	5

- ① 400 V = rated voltage
- 6 kV = rated impulse voltage
- 3 = pollution degree
- (see Section 15)

Please observe the application notes:
 Insulation stop, page 382
 Comb-style jumper bar, page 383
 Marking, from page 640

Approvals and corresponding ratings,
 visit www.wago.com

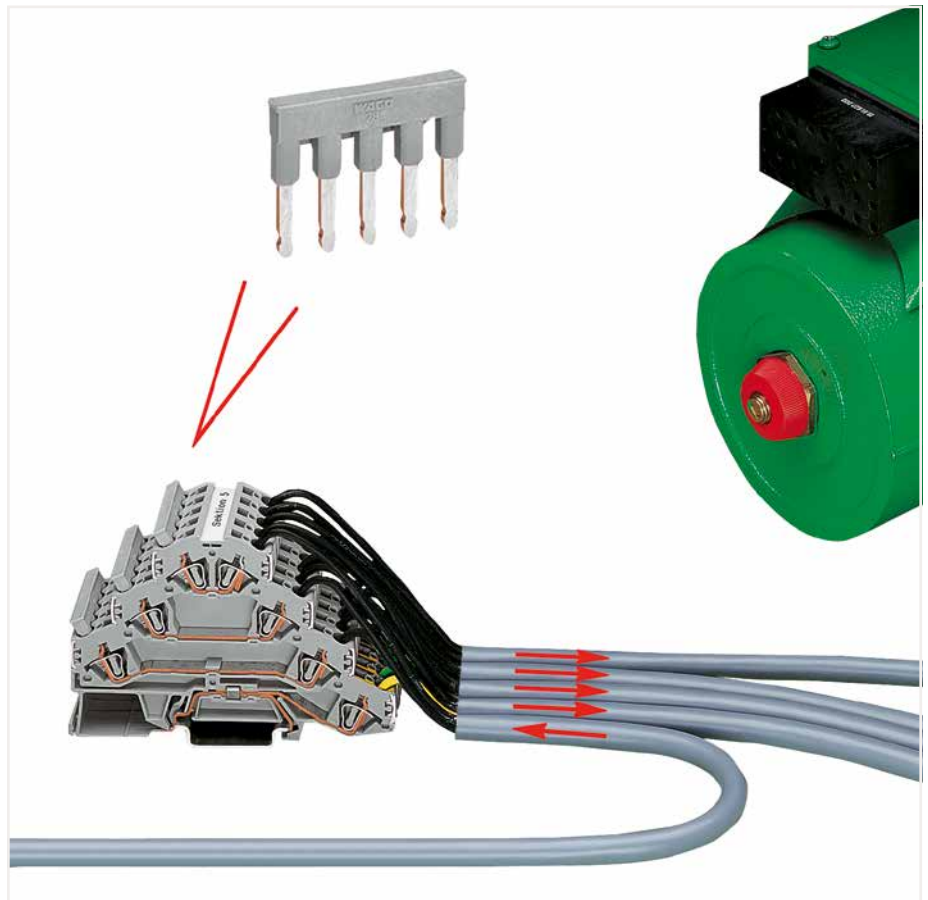

6



In addition to rail-mount terminal blocks for electric motor wiring, special versions are also available:

- Version **without** ground contact and only two potentials: These terminal blocks were custom designed to support additional functions, such as engine brakes or temperature sensors. Sharing a common profile, this terminal block version can be put next to the appropriate electric motor wiring terminal block without using intermediate plates. That makes the rail assembly easier to understand and wire. This also prevents wiring errors as no conductor entry is unused.
- Version **without** ground contact and with three potentials:

Clearly designated clamping units are the primary advantage to this terminal block design. When using devices with protective insulation, for example, there are no open ground clamping units that could create confusion.



Commoning using comb-style jumper bars.
 Push comb-style jumper bars down until fully inserted.



Testing with voltage tester.



Marking clamping points via WMB Multi Marking System.
 Marking groups via marking strips (709-177).

Rail-Mount Terminal Blocks TOPJOB® Classic

780 ... 785 Series

Description and Installation

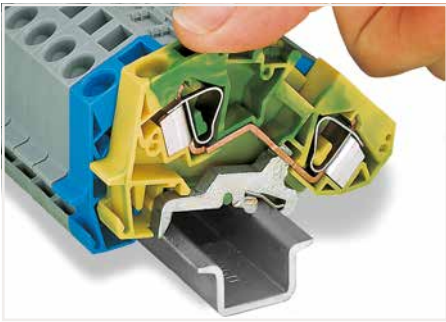

By snapping a ground conductor terminal block onto the DIN-rail, a direct electrical connection is automatically made to the rail.



Removing a terminal block from the assembly.

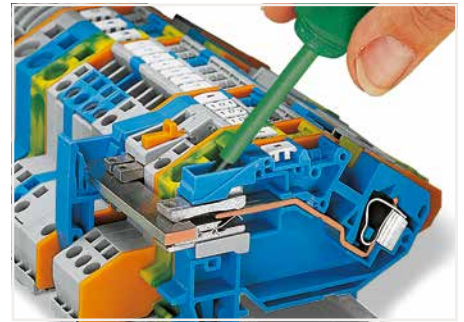

Operating an N-disconnect slide link.



Commoning ground conductor terminal blocks with through terminal blocks is possible in one direction only (via rear side of terminal block) using adjacent jumpers. Recommends using yellow-green adjacent jumpers in addition to the required marking of these blocks.



Staggered jumpers for sophisticated circuit requirements – push jumpers down until fully inserted.

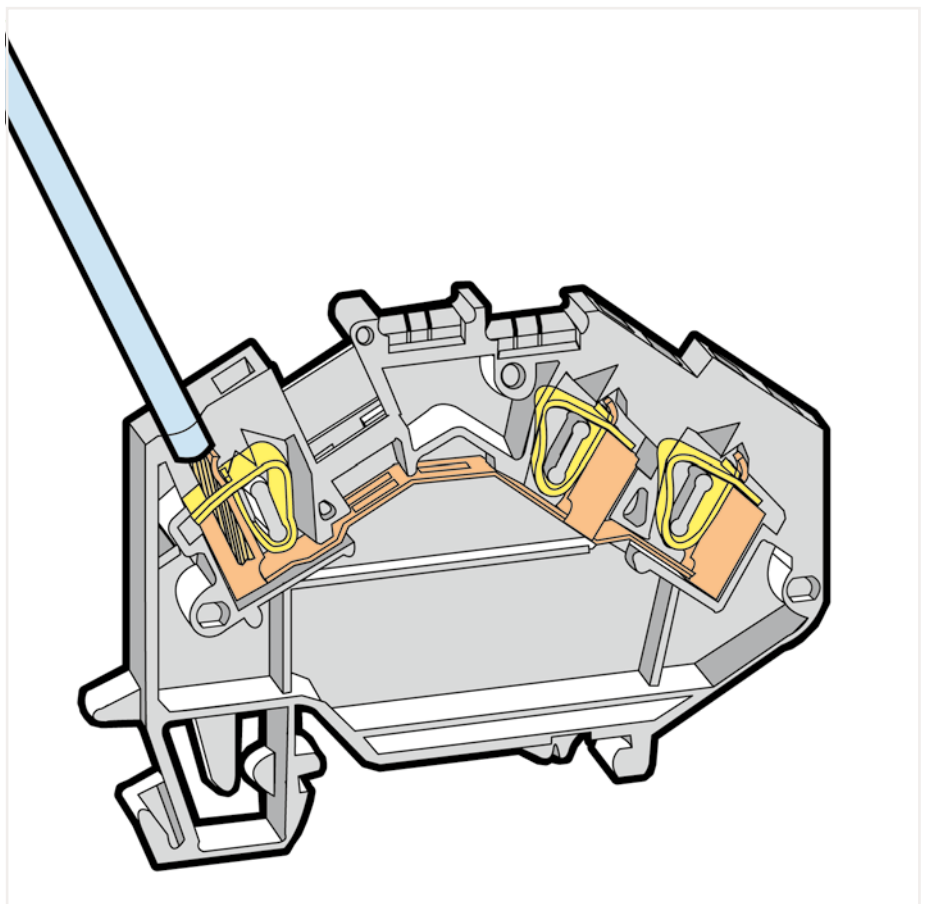

Test plug module assembly – combining test plug and spacer modules.



Insulation stop: Prevents the conductor insulation from being pushed into the clamping unit. (Available for terminal blocks up to 4 mm²/12 AWG)



Labeling via WMB Multi markers and WFB continuous marking strips.

CAGE CLAMP® terminates the following copper conductors:
solid "s" stranded "st"

fine-stranded "f-st", also with tinned single strands

fine-stranded, tip-bonded

fine-stranded, with ferrule (gastight crimped)

fine-stranded, with pin terminal (gastight crimped)

For aluminum conductors, see notes in Section 15. With ferruled conductors, it is necessary to use a terminal block one size larger than the conductor's nominal cross section.

6

Through/Ground Conductor/Shield Conductor and Ex Terminal Block TOPJOB® Classic 2.5 mm²; 780 Series

Technical Data	
0.08 ... 2.5 mm ²	28 ... 12 AWG*
1000 V/8 kV/3 ①	600 V, 20 A ②
I _N 24 A	600 V, 20 A ②
Terminal block width: 5 mm / 0.197 inch	
 8 ... 9 mm / 0.31 ... 0.35 inch	

Technical Data	
0.08 ... 2.5 mm ²	28 ... 12 AWG*
1000 V/8 kV/3 ①	600 V, 20 A ②
I _N 24 A	600 V, 25 A ③
Terminal block width: 5 mm / 0.197 inch	
 8 ... 9 mm / 0.31 ... 0.35 inch	

*12 AWG: THHN, THWN
① 1000 V = rated voltage 8 kV = rated impulse voltage 3 = pollution degree (see Section 15)

- ② Terminal blocks with a blue insulated housing are suitable for Ex i applications.
- ③ Terminal blocks with an Ex mark are suitable for Ex e II applications.
0.2 ... 2.5 mm² / 24 ... 12 AWG*
690 V; 23 A
(see Section 15)
Using staggered jumpers reduces the maximum rated voltage to 275 V.

Please observe the application notes:
Insulation stop, page 382
Jumpers, from page 384
Comb-style jumper bar, page 383
Testing accessories, from page 378
Marking, from page 640

Approvals and corresponding ratings, visit www.wago.com

Accessories; 780 Series

Appropriate marking systems:
WMB/WMB Inline/WFB

Test plug module; snaps together; 5 mm wide

	gray	280-418	100 (25)
--	------	---------	----------

Spacer module; snaps together; 5 mm wide

	gray	280-419	100 (25)
---	------	---------	----------

Test plug adapter; 8.3 mm wide; for 4 mm Ø test plug; for 1.5 ... 10 mm² terminal blocks

	gray	209-170	50 (25)
---	------	---------	---------

Test plug adapter; 5 mm wide; for 4 mm Ø test plug; for 1.5 ... 4 mm² terminal blocks

	gray	280-404	100 (25)
---	------	---------	----------

Test plug adapter; 6 mm wide; with CAGE CLAMP®; for 0.08 ... 2.5 mm²

	I _N 24 A	281-407	100 (25)
---	---------------------	---------	----------

WFB continuous marking strip; 1000 mm long

	transparent	210-612	10
---	-------------	---------	----

Carrier for WFB continuous marking strip; snaps into marker slot

	gray	209-185	200 (25)
---	------	---------	----------

Operating tool; specialty blade; for all TOPJOB® terminal blocks

		777-310	1
---	--	---------	---

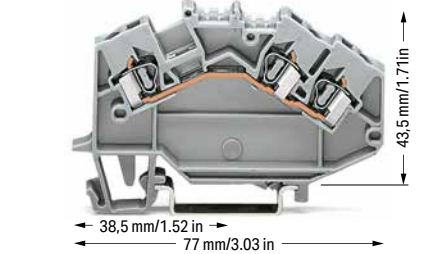
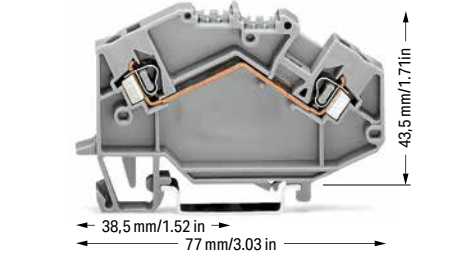



2-conductor through terminal block

Color	Item No.	Pack. Unit
gray	780-601	50
blue	780-604 ②	50
orange	780-602	50
light gray ③	780-992 ③	50



3-conductor through terminal block

Color	Item No.	Pack. Unit
gray	780-631	50
blue	780-651 ②	50
orange	780-654	50
light gray ③	780-993 ③	50

2-conductor ground terminal block

	green-yellow	780-607	50
	green-yellow ③	780-607/999-950 ③	50

3-conductor ground terminal block

	green-yellow	780-637	50
	green-yellow ③	780-637/999-950 ③	50

3-conductor shield terminal block

	white	780-640	50
---	-------	---------	----

Other terminal blocks with the same profile:

N-disconnect	780-613	Page 307
--------------	---------	----------

Accessories; 780 Series

Appropriate marking systems: WMB/WMB Inline/WFB

End and intermediate plate; 1.5 mm thick

	orange	780-317	100 (25)
---	--------	---------	----------

Alternate jumper; insulated; I_N = I_N terminal block

	gray	280-409	100 (25)
---	------	---------	----------

Ex e/Ex i separator; orange; 3 mm thick

	125.5 mm	209-192	50 (25)
---	----------	---------	---------

Staggered jumper; insulated; 5 mm wide; I_N 24 A

	1 to 2	780-452	100 (25)
	1 to 3	780-453	100 (25)
	1 to 4	780-454	100 (25)
	1 to 5	780-455	50 (25)
	1 to 6	780-456	50 (25)
	1 to 7	780-457	50 (25)
	1 to 8	780-458	50 (25)

Insulation stop; 0.08 ... 0.2 mm² "s" (0.14 mm² "f-st"); 5 pcs/strip

	white	280-470	200 (25)
---	-------	---------	----------

Push-in type wire jumper; insulated; 0.75 mm² conductor cross section; I_N 9 A

	L = 60 mm	249-125	100 (10)
	L = 110 mm	249-126	100 (10)
	L = 250 mm	249-127	100 (10)

Insulation stop; 0.25 ... 0.5 mm²; 5 pcs/strip

	light gray	280-471	200 (25)
---	------------	---------	----------

Comb-style jumper bar; insulated; I_N = I_N of terminal block

	2-way	280-482	200 (25)
	3-way	280-483	200 (25)
	10-way	280-490	50 (25)

Insulation stop; 0.75 ... 1 mm²; 5 pcs/strip

	dark gray	280-472	200 (25)
---	-----------	---------	----------

Alternate comb-style jumper bar; insulated; I_N = I_N of terminal block

	2-way	280-492	200 (25)
---	-------	---------	----------

Protective warning marker; with black high-voltage symbol; for 5 terminal blocks

	yellow	280-415	100 (25)
---	--------	---------	----------

Adjacent jumper; insulated; I_N = I_N terminal block

	gray	280-402	200 (25)
	yellow-green	280-422	200 (25)

Operating tool; insulated

	2-way	280-432	1
	3-way	280-433	1
	10-way	280-440	1

Through/Ground Conductor and Ex Terminal Block TOPJOB® Classic 4 mm²; 781 Series

Technical Data	
0.08 ... 4 mm ²	28 ... 12 AWG
1000 V/8 kV/3 ①	600 V, 20 A ②
I _N 32 A	600 V, 20 A ③
Terminal block width: 6 mm / 0.236 inch	
9 ... 10 mm / 0.35 ... 0.39 inch	

Technical Data	
0.08 ... 4 mm ²	28 ... 12 AWG
1000 V/8 kV/3 ①	600 V, 20 A ②
I _N 32 A	600 V, 20 A ③
Terminal block width: 6 mm / 0.236 inch	
9 ... 10 mm / 0.35 ... 0.39 inch	

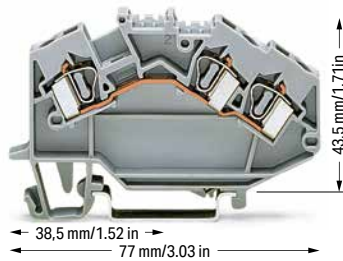
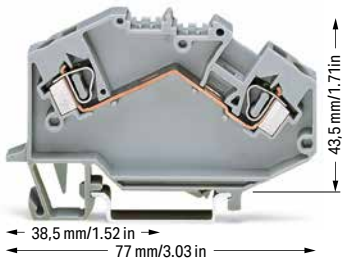

2-conductor through terminal block		
Color	Item No.	Pack. Unit
gray	781-601	50
blue	781-604 ②	50
light gray ③	781-992 ③	50

3-conductor through terminal block		
Color	Item No.	Pack. Unit
gray	781-631	50
blue	781-651 ②	50
light gray ③	781-993 ③	50

2-conductor ground terminal block		
green-yellow	781-607	50
green-yellow ③	781-607/999-950 ③	50

3-conductor ground terminal block		
green-yellow	781-637	50
green-yellow ③	781-637/999-950 ③	50

Other terminal blocks with the same profile:		
N-disconnect	781-613	Page 307
Potential	781-623	Page 307

Other terminal blocks with the same profile:		
N-disconnect	781-643	Page 307
Potential	781-653	Page 307

Accessories; 781 Series
Appropriate marking systems: WMB/WMB Inline/WFB

End and intermediate plate; 1.5 mm thick		
orange	780-317	100 (25)

Alternate jumper; insulated; I _N = I _N terminal block		
gray	281-409	100 (25)

Ex e/Ex i separator; orange; 3 mm thick		
125.5 mm	209-192	50 (25)

Staggered jumper; insulated; 6 mm wide; I _N 32 A		
1 to 2	781-452	100 (25)
1 to 3	781-453	100 (25)
1 to 4	781-454	100 (25)
1 to 5	781-455	50 (25)
1 to 6	781-456	50 (25)

Insulation stop; 0.08 ... 0.2 mm ² "s" (0.14 mm ² "f-st"); 5 pcs/strip		
white	281-470	200 (25)

Push-in type wire jumper; insulated; 0.75 mm ² conductor cross section; I _N 9 A		
L = 60 mm	249-125	100 (10)
L = 110 mm	249-126	100 (10)
L = 250 mm	249-127	100 (10)

Insulation stop; 0.25 ... 0.5 mm ² ; 5 pcs/strip		
light gray	281-471	200 (25)

Comb-style jumper bar; insulated; I _N = I _N of terminal block		
2-way	281-482	100 (25)
3-way	281-483	100 (25)
5-way	281-485	100 (25)
10-way	281-490	50 (25)

Insulation stop; 0.75 ... 1.5 mm ² ; 5 pcs/strip		
dark gray	281-472	200 (25)

Alternate comb-style jumper bar; insulated; I _N = I _N of terminal block		
2-way	281-492	100 (25)

Protective warning marker; with black high-voltage symbol; for 5 terminal blocks		
yellow	281-415	100 (25)

Operating tool; insulated		
2-way	280-432	1
3-way	280-433	1
5-way	281-440	1

Adjacent jumper; insulated; I _N = I _N terminal block		
gray	281-402	200 (25)
yellow-green	281-422	200 (25)

① 1000 V = rated voltage
8 kV = rated impulse voltage
3 = pollution degree
(see Section 15)

② Terminal blocks with a blue insulated housing are suitable for Ex i applications.

③ Terminal blocks with an Ex mark are suitable for Ex e II applications.
0.2 ... 4 mm² / 24 ... 12 AWG
690 V
30 A, for 2-conductor terminal blocks
27 A, for 3-conductor terminal blocks
(see Section 15)
Using staggered jumpers reduces the maximum rated voltage to 275 V.

Please observe the application notes:
Insulation stop, page 382
Jumpers, from page 384
Comb-style jumper bar, page 383
Testing accessories, from page 378
Marking, from page 640

Approvals and corresponding ratings, visit www.wago.com

Accessories; 781 Series

Appropriate marking systems:
WMB/WMB Inline/WFB

Test plug module; snaps together; 6 mm wide		
gray	280-418	100 (25)

Spacer module; snaps together; 5 mm wide		
gray	280-419	100 (25)

Test plug adapter; 8.3 mm wide; for 4 mm Ø test plug; for 1.5 ... 10 mm ² terminal blocks		
gray	209-170	50 (25)

Test plug adapter; 5 mm wide; for 4 mm Ø test plug; for 1.5 ... 4 mm ² terminal blocks		
gray	280-404	100 (25)

Test plug adapter; 6 mm wide; with CAGE CLAMP®; for 0.08 ... 2.5 mm ²		
I _N 24 A	281-407	100 (25)

WFB continuous marking strip; 1000 mm long		
transparent	210-612	10

Carrier for WFB continuous marking strip; snaps into marker slot		
gray	209-185	200 (25)

Operating tool; specialty blade; for all TOPJOB® terminal blocks		
	777-310	1

6

Through/Ground Conductor and Ex Terminal Block TOPJOB® Classic

6 mm²; 782 Series and 10 (16) mm²; 784 Series

Technical Data	
0.2 ... 6 mm ²	24 ... 10 AWG
1000 V/8 kV/3 ②	600 V, 30 A ③
I _N 41 A	600 V, 25 A ④
Terminal block width: 8 mm / 0.315 inch	
 12 ... 13 mm / 0.47 ... 0.51 inch	

Technical Data	
0.2 ... 10 (16) mm ² ①	24 ... 6 AWG
1000 V/8 kV/3 ②	600 V, 50 A ③
I _N 57 A	600 V, 35 A ④
Terminal block width: 10 mm / 0.394 inch	
 12 ... 13 mm / 0.47 ... 0.51 inch	

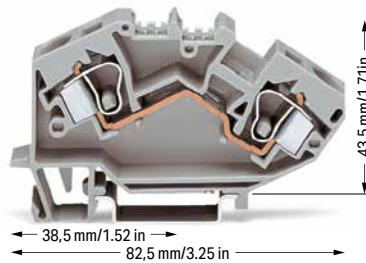
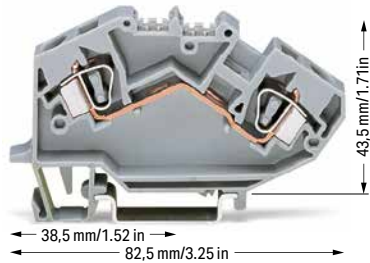

2-conductor through terminal block		
Color	Item No.	Pack. Unit
○ gray	782-601	25
● blue	782-604 ⑤	25
○ light gray ⑥	782-992 ④	50



2-conductor through terminal block		
Color	Item No.	Pack. Unit
○ gray	784-601	25
● blue	784-604 ⑤	25
○ light gray ⑥	784-992 ⑤	25



2-conductor ground terminal block		
Color	Item No.	Pack. Unit
● green-yellow	782-607	25
● green-yellow ⑥	782-607/999-950 ④	25

2-conductor ground terminal block		
Color	Item No.	Pack. Unit
● green-yellow	784-607	25
● green-yellow ⑥	784-607/999-950 ⑤	25

Other terminal blocks with the same profile:		
N-disconnect	782-613	Page 308
Potential	782-623	Page 308

Other terminal blocks with the same profile:		
N-disconnect	784-613	Page 308
Potential	784-623	Page 308

Accessories; item-specific			
Adjacent jumper; insulated; I _N 41 A			
	gray	282-402	100 (25)
	yellow-green	282-422	100 (25)

Accessories; item-specific			
Adjacent jumper; insulated; I _N 57 A			
	gray	284-402	100 (25)
	yellow-green	284-422	100 (25)

Alternate jumper; insulated; I _N 41 A			
	gray	282-409	100 (25)

Alternate jumper; insulated; I _N 57 A			
	gray	284-409	50 (25)

Protective warning marker; with black high-voltage symbol; for 5 terminal blocks			
	yellow	282-415	100 (25)

Protective warning marker; with black high-voltage symbol; for 5 terminal blocks			
	yellow	284-415	50 (25)

B-type test plug module; snaps together; 8 mm wide			
	gray	709-310	100 (25)

B-type test plug module; snaps together; 8 mm wide			
	gray	709-310	100 (25)

B-type spacer module; snaps together; 8 mm wide			
	gray	709-311	100 (25)

B-type spacer module; snaps together; 8 mm wide			
	gray	709-311	100 (25)

B-type spacer plate; snaps together; 2 mm wide			
	gray	709-312	100 (25)

Finger guard; touch-proof cover protects unused conductor entries			
	yellow	284-400	100 (25)

- ① Max. conductor cross section: 16 mm²
- ② 1000 V = rated voltage
8 kV = rated impulse voltage
3 = pollution degree (see Section 15)
- ③ Terminal blocks with a blue insulated housing are suitable for Ex i applications.
- ④ Terminal blocks with an Ex mark are suitable for Ex e II applications.
0.2 ... 6 mm² / 24 ... 10 AWG
690 V; 39 A (see Section 15)
- ⑤ Terminal blocks with an Ex mark are suitable for Ex e II applications.
0.2 ... 10 mm²/24 ... 8 AWG
690 V; 53 A (see Section 15)

Please observe the application notes:
Test plug module, page 381
Marking, from page 640

Approvals and corresponding ratings, visit www.wago.com

Accessories
Appropriate marking systems:
WMB/WMB InLine/WFB

End and intermediate plate; 1.5 mm thick		
	orange	782-317 100 (25)

Ex e/Ex i separator; orange; 3 mm thick		
	125.5 mm	209-192 50 (25)

Test plug adapter; 8.3 mm wide; for 4 mm Ø test plug; for 1.5 ... 10 mm ² terminal blocks			
	gray	209-170	50 (25)

Busbar carrier; with end stop function and detachable separator plate; snaps onto DIN-35 rail; 8 mm thick			
	blue	777-305	25

WFB continuous marking strip; 1000 mm long			
	transparent	210-612	10

Carrier for WFB continuous marking strip; snaps into marker slot			
	gray	209-185	200 (25)

Operating tool; specialty blade; for all TOPJOB® terminal blocks			
		777-310	1

Through/Ground Conductor and Ex Terminal Block TOPJOB® Classic



16 mm²; 783 Series and 35 mm²; 785 Series

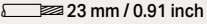

Technical Data	
0.2 ... 16 mm ²	24 ... 6 AWG
1000 V/8 kV/3 ①	600 V, 65 A W
I _N 76 A	600 V, 50 A @
Terminal block width: 12 mm / 0.472 inch	
 16 ... 17 mm / 0.63 ... 0.67 inch	

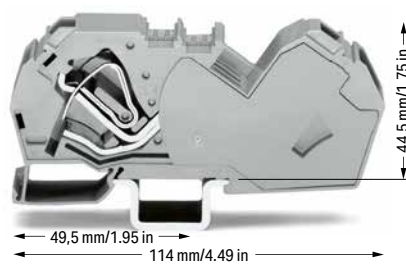
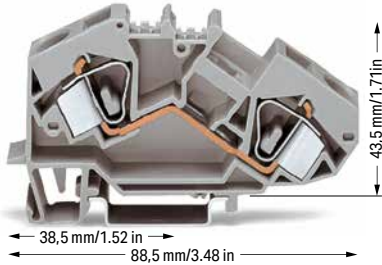
Technical Data	
6 ... 35 mm ²	8 ... 2 AWG
1000 V/8 kV/3 ①	600 V, 115 A W
I _N 125 A	600 V, 125 A @
Terminal block width: 16 mm / 0.63 inch	
 23 mm / 0.91 inch	

- ① 1000 V = rated voltage
8 kV = rated impulse voltage
3 = pollution degree
(see Section 15)
 - ② Terminal blocks with a blue insulated housing are suitable for Ex i applications.
 - ④ Terminal blocks with an Ex mark are suitable for Ex e II applications.
0.2 ... 6 mm² / 24 ... 10 AWG
690 V; 39 A
(see Section 15)
 - ⑤ Terminal blocks with an Ex mark are suitable for Ex e II applications.
0.2 ... 10 mm²/24 ... 8 AWG
690 V; 53 A
(see Section 15)
- Please observe the application notes:
Marking, from page 640
- Approvals and corresponding ratings,
visit www.wago.com



2-conductor through terminal block		
Color	Item No.	Pack. Unit
 gray	783-601	25
 blue	783-604 ②	25
 light gray ⑤	783-992 ③	25

2-conductor through terminal block		
Color	Item No.	Pack. Unit
 gray	785-601	25
 blue	785-604	25

2-conductor ground terminal block		
 green-yellow	783-607	25
 green-yellow ④	783-607/999-950 ④	25

2-conductor ground terminal block		
 green-yellow	785-607	25

Other terminal blocks with the same profile:		
N-disconnect	783-613	Page 308
Potential	783-623	Page 308

Other terminal blocks with the same profile:		
N-disconnect	785-613	Page 309
Potential	785-623	Page 309

Accessories; item-specific			
End and intermediate plate; 1.5 mm thick			
	orange	783-317	100 (25)



Accessories; item-specific			
Adjacent jumper; insulated; I _N 85 A			
	gray	285-435	50 (25)

Protective warning marker; with black high-voltage symbol; for 5 terminal blocks			
	yellow	283-415	50 (25)

Protective warning marker; with black high-voltage symbol; for 5 terminal blocks			
	yellow	285-416	50 (25)

Finger guard; touch-proof cover protects unused conductor entries			
	yellow	283-400	100 (25)

Finger guard; touch-proof cover protects unused conductor entries			
	yellow	285-401	100

Adjacent jumper; insulated; I _N 70 A			
	gray	283-402	100 (25)
	yellow-green	283-422	100 (25)

Power tap; I _N 24 A; with 500 mm cable; for 16 mm ² (283/783 Series) and 35 mm ² (285/785 Series) rail-mount terminal blocks			
	gray	283-407	25

Alternate jumper; insulated; I _N 76 A			
	gray	283-409	100 (25)

Test plug adapter; 11.6 mm wide; for 4 mm Ø test plug; for 1.5 ... 16 mm ² terminal blocks			
	gray	283-404	25

Power tap; I _N 24 A; with 500 mm cable; for 16 mm ² (283/783 Series) and 35 mm ² (285/785 Series) rail-mount terminal blocks			
	gray	283-407	25

Test plug adapter; 11.6 mm wide; for 4 mm Ø test plug; for 1.5 ... 16 mm ² terminal blocks			
	gray	283-404	25

Accessories

Appropriate marking systems:
WMB/WMB Inline/WFB

Test plug adapter; 8.3 mm wide; for 4 mm Ø test plug; for 1.5 ... 10 mm² terminal blocks

	gray	283-404	25
--	------	---------	----

Busbar carrier; with end stop function and detachable separator plate; snaps onto DIN-35 rail; 8 mm thick

	blue	777-305	25
---	------	---------	----

WMB marking card; white; 10 strips with 10 markers/card; for 5 ... 17.5 mm terminal block width

	plain	793-501	5
---	-------	---------	---

WMB marking card; white; 10 strips with 10 markers/card; stretchable 5 ... 5.2 mm

	plain	793-5501	5
---	-------	----------	---

WFB continuous marking strip; 1000 mm long

	transparent	210-612	10
---	-------------	---------	----

Carrier for WFB continuous marking strip; snaps into marker slot

	gray	209-185	200 (25)
---	------	---------	----------

Operating tool; specialty blade; for all TOPJOB® terminal blocks

		777-310	1
---	--	---------	---

6

N-Disconnect Terminal Block and Power Distribution Disconnect Terminal Block

TOPJOB® Classic

2.5 mm²; 780 Series and 4 mm²; 781 Series

Technical Data	
0.08 ... 2.5 mm ²	28 ... 12 AWG*
400 V/6 kV/3 ①	600 V, 20 A ②
I _N 24 A	
Terminal block width: 5 mm / 0.197 inch	
8 ... 9 mm / 0.31 ... 0.35 inch	

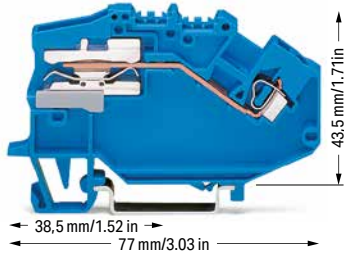

1-conductor N-disconnect terminal block		
Color	Item No.	Pack. Unit
● blue	780-613 ②	50

Other terminal blocks with the same profile:		
Through	780-601	Page 303

Technical Data	
0.08 ... 4 mm ²	28 ... 12 AWG
400 V/6 kV/3 ①	600 V, 20 A ②
I _N 32 A	
Terminal block width: 6 mm / 0.236 inch	
9 ... 10 mm / 0.35 ... 0.39 inch	



1-conductor N-disconnect terminal block		
Color	Item No.	Pack. Unit
● blue	781-613 ②	50

1-conductor power distribution disconnect terminal block		
○ gray	781-623 ③	50

Other terminal blocks with the same profile:		
Through	781-601	Page 304

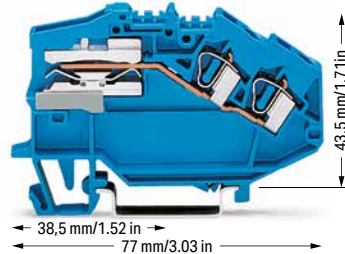

2-conductor N-disconnect terminal block		
Color	Item No.	Pack. Unit
● blue	781-643 ②	50

2-conductor power distribution disconnect terminal block		
○ gray	781-653 ③	50

Other terminal blocks with the same profile:		
Through	781-631	Page 304

- *12 AWG: THHN, THWN
- ① 400 V = rated voltage
6 kV = rated impulse voltage
3 = pollution degree (see Section 15)
- ② See page 309
- ③ See page 309
- Approvals and corresponding ratings, visit www.wago.com

Accessories
Appropriate marking systems:
WMB/WMB Inline/WFB

End and intermediate plate; 1.5 mm thick		
orange	780-317	100 (25)

Busbar carrier; not suitable as an end stop; snaps onto DIN-35 rail; 1.5 mm thick

blue	780-321	100 (25)
------	---------	----------

Busbar carrier; with end stop function and detachable separator plate; snaps onto DIN-35 rail; 8 mm thick

blue	777-305	25
------	---------	----

Busbar; tin-plated; 1000 mm long; copper (10 x 3) mm

I _N 140 A	210-133	1
----------------------	---------	---

Busbar cover; 1000 mm long

transparent	777-303	1
-------------	---------	---

Connector; for busbar; with blue cover; 2.5 ... 16 mm²

blue	210-281	100 (50)
------	---------	----------

Connector; for busbar; 2.5 ... 35 mm²

unplated	209-105	50
----------	---------	----

Lock-out; prevents reclosing of slide link; snap-on type

orange	777-300	100 (25)
--------	---------	----------

Step-down test plug; from 4 mm socket to 2 mm plug; max. 42 V

red	210-297	100 (25)
-----	---------	----------

Operating tool; specialty blade; for all TOPJOB® terminal blocks

	777-310	1
--	---------	---

6

N-Disconnect Terminal Block and Power Distribution Disconnect Terminal Block

TOPJOB® Classic

6 mm²; 782 Series and 10 (16) mm²; 784 Series and 16 mm²; 783 Series and 35 mm²; 785 Series

Technical Data	
0.2 ... 6 mm ²	24 ... 10 AWG
400 V/6 kV/3 ②	600 V, 30 A ③
I _N 41 A	
Terminal block width: 8 mm / 0.315 inch	
12 ... 13 mm / 0.47 ... 0.51 inch	

Technical Data	
0.2 ... 10 (16) mm ² ①	24 ... 6 AWG
400 V/6 kV/3 ②	
I _N 57 A	
Terminal block width: 10 mm / 0.394 inch	
12 ... 13 mm / 0.47 ... 0.51 inch	

Technical Data	
0.2 ... 16 mm ²	24 ... 6 AWG
400 V/6 kV/3 ②	600 V, 65 A ③
I _N 68 A	
Terminal block width: 12 mm / 0.472 inch	
16 ... 17 mm / 0.63 ... 0.67 inch	

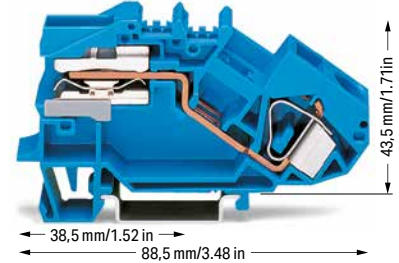
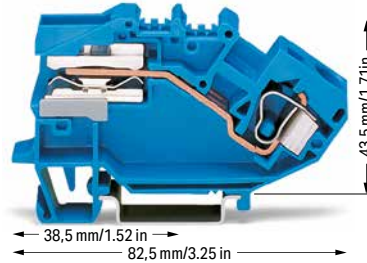
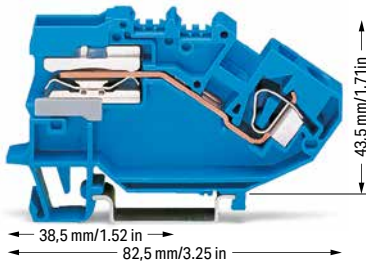

1-conductor N-disconnect terminal block		
Color	Item No.	Pack. Unit
● blue	782-613	25

1-conductor N-disconnect terminal block		
Color	Item No.	Pack. Unit
● blue	784-613	25

1-conductor N-disconnect terminal block		
Color	Item No.	Pack. Unit
● blue	783-613	25

1-conductor power distribution disconnect terminal block		
Color	Item No.	Pack. Unit
○ gray	782-623	25

1-conductor power distribution disconnect terminal block		
Color	Item No.	Pack. Unit
○ gray	784-623	25

1-conductor power distribution disconnect terminal block		
Color	Item No.	Pack. Unit
○ gray	783-623	25

Other terminal blocks with the same profile:		
Through	782-601	Page 305

Other terminal blocks with the same profile:		
Through	784-601	Page 305

Other terminal blocks with the same profile:		
Through	783-601	Page 306

Accessories; item-specific			
Busbar carrier; not suitable as an end stop; snaps onto DIN-35 rail; 1.5 mm thick			
	blue	782-321	100 (25)

Accessories; item-specific			
Busbar carrier; not suitable as an end stop; snaps onto DIN-35 rail; 1.5 mm thick			
	blue	782-321	100 (25)

Accessories; item-specific			
Busbar carrier; not suitable as an end stop; snaps onto DIN-35 rail; 1.5 mm thick			
	blue	783-321	100 (25)

Accessories

Busbar carrier; with end stop function and detachable separator plate; snaps onto DIN-35 rail; 8 mm thick			
	blue	777-305	25

Appropriate marking systems: WMB/WMB Inline/WFB			
Step-down test plug; from 4 mm socket to 2 mm plug; max. 42 V			
	red	210-297	100 (25)

Busbar; tin-plated; 1000 mm long; copper (10 x 3) mm			
	I _N 140 A	210-133	1

WMB marking card; white; 10 strips with 10 markers/card; for 5 ... 17.5 mm terminal block width			
	plain	793-501	5

Busbar cover; 1000 mm long			
	transparent	777-303	1

WMB marking card; white; 10 strips with 10 markers/card; stretchable 5 ... 5.2 mm			
	plain	793-5501	5

Connector; for busbar; with blue cover; 2.5 ... 16 mm ²			
	blue	210-281	100 (50)

WFB continuous marking strip; 1000 mm long			
	transparent	210-612	10

Connector; for busbar; 2.5 ... 35 mm ²			
	unplated	209-105	50

Carrier for WFB continuous marking strip; snaps into marker slot			
	gray	209-185	200 (25)

Lock-out; prevents reclosing of slide link; snap-on type			
	orange	782-300	100 (25)

Operating tool; specialty blade; for all TOPJOB® terminal blocks			
		777-310	1

Technical Data6 ... 35 mm² | 8 ... 2 AWG

400 V/6 kV/3 ②

I_N 125 A | 600 V, 125 AⓈ

Terminal block width: 16 mm / 0.63 inch

23 mm / 0.91 inch

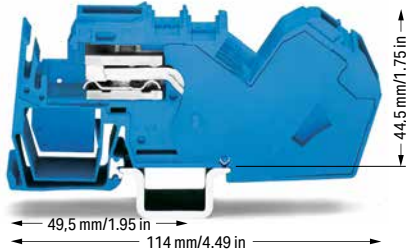
**1-conductor N-disconnect terminal block**

Color	Item No.	Pack. Unit
● blue	785-613	15

1-conductor power distribution disconnect terminal block

○ gray	785-623	15
--------	---------	----

Other terminal blocks with the same profile:

Through	783-601	Page 306
---------	---------	----------

Accessories; item-specific

Busbar carrier; not suitable as an end stop; snaps onto DIN-35 rail; 1.5 mm thick

	blue	783-321	100 (25)
---	------	---------	----------

① Max. conductor cross section: 16 mm²② 400 V = rated voltage
6 kV = rated impulse voltage
3 = pollution degree
(see Section 15)

③ See column 5 (bottom)

④ See column 6 (bottom)

Approvals and corresponding ratings,
visit www.wago.com

The 35 mm² (2 AWG) terminal blocks are the latest addition to WAGO TOPJOB®, the professional range of rail-mount terminal blocks for building installations. These terminal blocks, which include an end plate, are just 16 mm wide. Their compact design allows them to fit into standard distribution boxes. The lower conductor entry angle makes it much easier to terminate 35 mm² (2 AWG) conductors.

Furthermore, the N-busbar holder is integrated into the terminal block, eliminating separate holders.

6



Removing the separator plate from the busbar carrier or from the N-disconnect terminal block.



Inserting the separator plate into the busbar carrier to protect the N-busbar against accidental contact.

N-conductor disconnect terminal blocks:

For the construction and operation of power installations in fire-prone, hazardous locations or public buildings – such as conference centers, stores, hospitals, schools, theaters or hotels – the DIN VDE 0100-710 or DIN VDE 0100-718 standards shall be observed. DIN VDE 0100-482 shall also be observed for fire-prone, hazardous locations. These VDE regulations mandate that every neutral conductor must be provided with a disconnection device so, e.g., insulation testing is possible for every circuit without disconnecting the N-conductor. WAGO's N-disconnect terminal blocks meet this requirement.

Power distribution disconnect terminal blocks:

According to DIN VDE 0100-710, "Requirements for operating facilities, rooms and special installations – medical facilities," equipotential bonding conductors shall be run on a potential equalization busbar. The potential equalization busbar and the protective ground conductor busbar must be mounted in a common housing and be connected to each other using a disconnectable copper conductor of minimum 16 mm² (6 AWG). Furthermore, all equipotential bonding conductors must be connected to the potential equalization busbar and clearly arranged so they can be disconnected individually and accessed at any time. Depending on their function, they must be provided with captive marking.

WAGO's power distribution disconnect terminal blocks meet these requirements.

Disconnect/Test Terminal Blocks; with a Pivoting Knife Disconnect

280 Series

Description and Installation

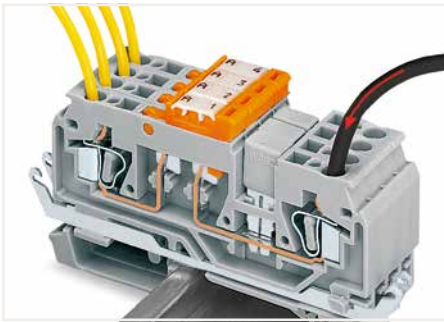

Power distribution using an adjacent jumper – knife disconnect used to disconnect individual outputs.



Pivoting a knife disconnect.

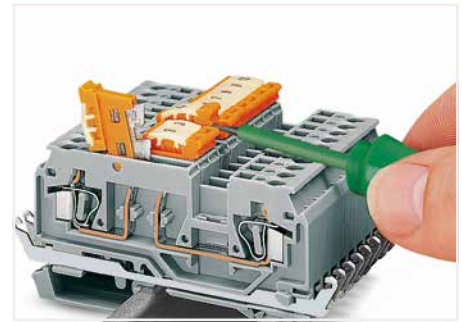

Pivoting knife disconnect clearly indicates circuit state by defined, notched positions "ON" ↔ "OFF."

6

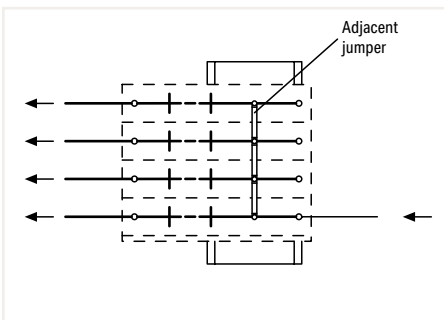
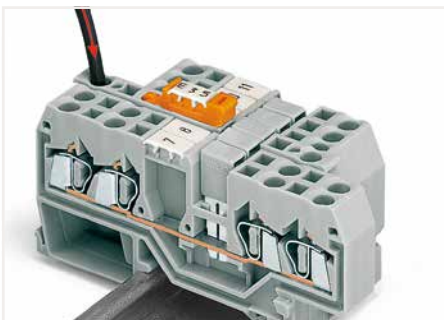

Diagram of the assembly as shown in the picture above



Power distribution using disconnect link in supply line – disconnection of all outputs.

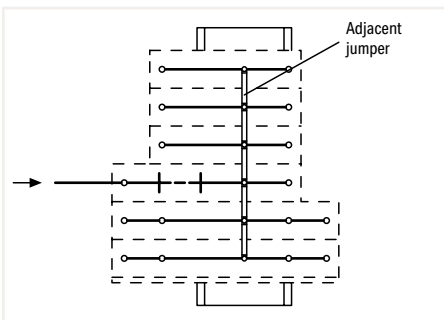
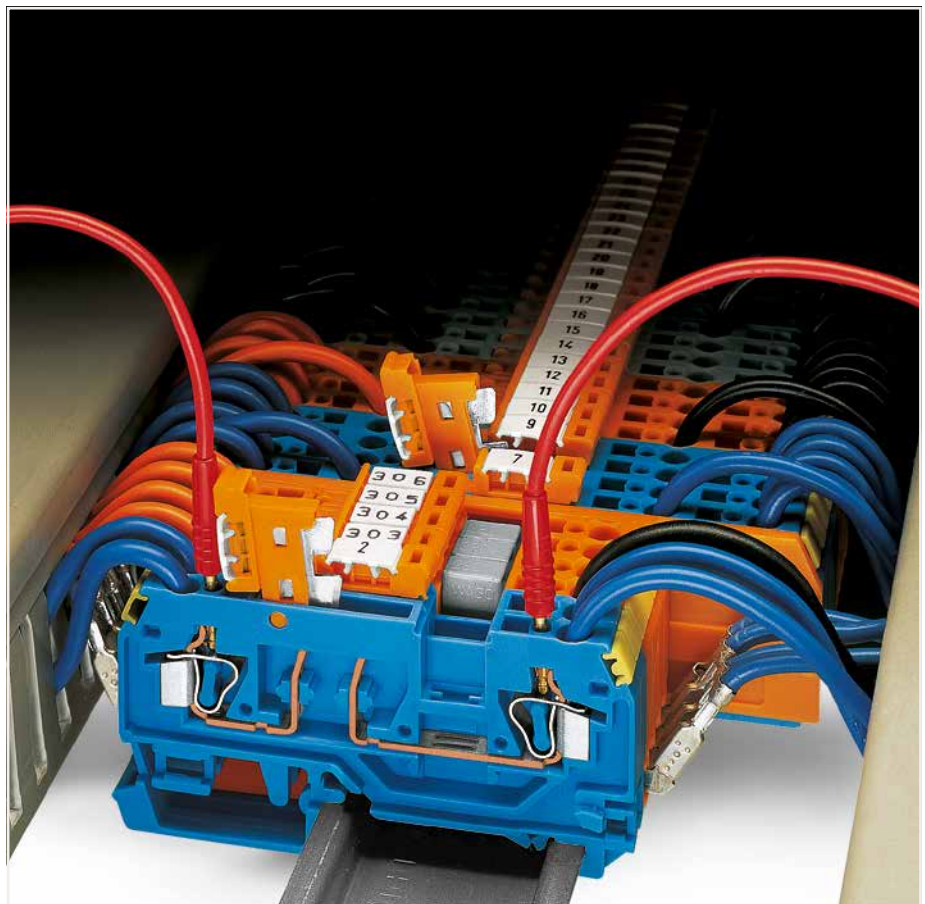
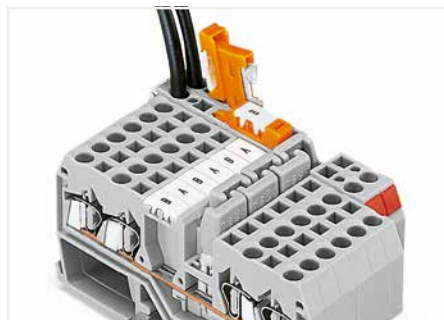

Diagram of the assembly as shown in the picture above



Staggered jumpers for sophisticated circuit requirements – push jumpers down until fully inserted.

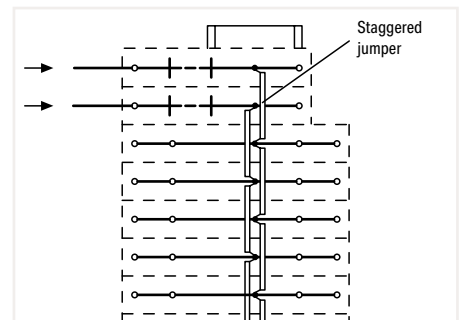

Diagram of the assembly as shown in the picture on the left



CAGE CLAMP® terminates the following copper conductors: solid "s"



stranded "st"



fine-stranded "f-st", also with tinned single strands

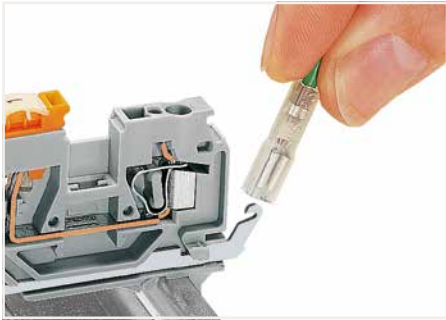

Shield contact via (2.5 x 0.8) mm solder/crimp quick disconnect terminal



Testing with voltage tester.



Terminal block marking: with WMB (center position) and Mini-WSB markers (on the sides)

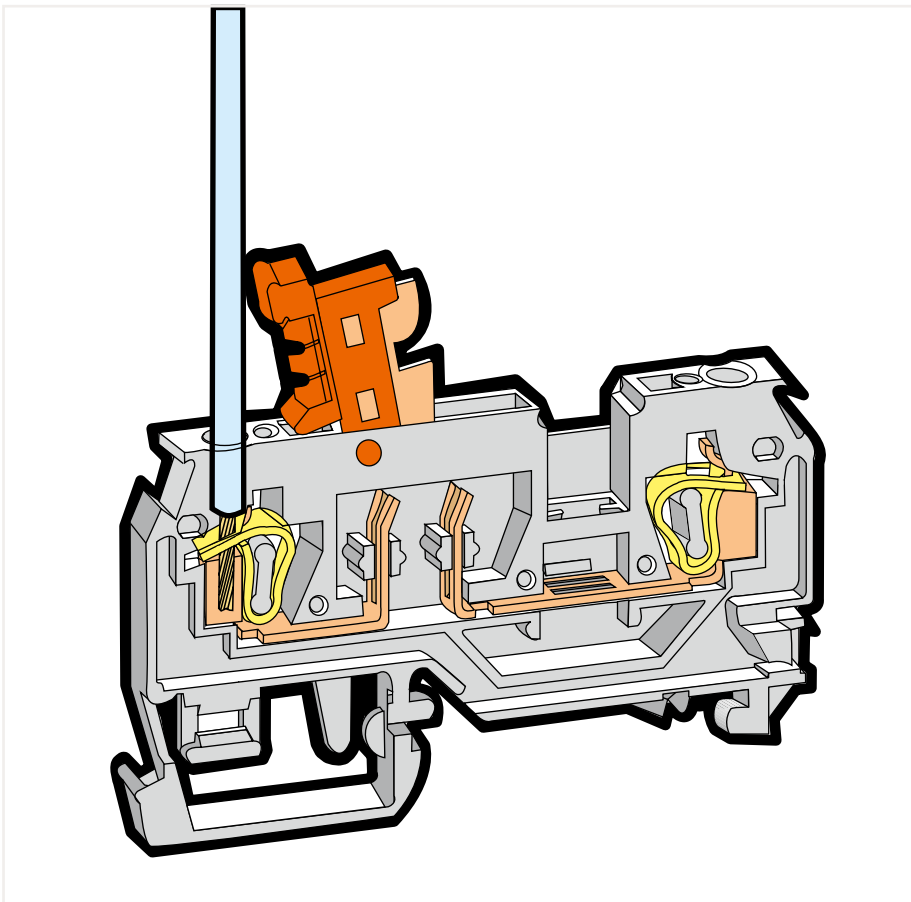

6



fine-stranded, tip-bonded



fine-stranded, with ferrule (gastight crimped)



fine-stranded, with pin terminal (gastight crimped)

2-Conductor Disconnect/Test Terminal Block without/with Shield Contact

2.5 mm²; 280 Series

Technical Data

0.08 ... 2.5 mm ²	28 ... 12 AWG*
400 V/6 kV/3 ①	600 V, 15 A I_N
I_N 16 A	300 V, 15 A I_N

Terminal block width: 5 mm / 0.197 inch

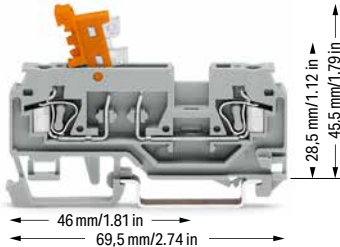
 8 ... 9 mm / 0.31 ... 0.35 inch

2-conductor disconnect/test terminal block; with shield port; with pivoting knife disconnect
Gray terminal block housing
Orange disconnect link

Color	Item No.	Pack. Unit
○ gray	280-870	100

Gray terminal block housing
Gray disconnect link

○ gray	280-868	100
--------	---------	-----

Blue terminal block housing
Orange disconnect link

● blue	280-876 ②	100
--------	-----------	-----

Orange terminal block housing
Orange disconnect link

● orange	280-879	100
----------	---------	-----

Accessories; 280 Series

Appropriate marking systems: WMB/WMB Inline/WFB

End and intermediate plate; 2.5 mm thick

orange	280-371	100 (25)
gray	280-374	100 (25)

Insulation stop; 0.08 ... 0.2 mm² "s" (0.14 mm² "f-st"); 5 pcs/strip

white	280-470	200 (25)
-------	---------	----------

Insulation stop; 0.25 ... 0.5 mm²; 5 pcs/strip

light gray	280-471	200 (25)
------------	---------	----------

Insulation stop; 0.75 ... 1 mm²; 5 pcs/strip

dark gray	280-472	200 (25)
-----------	---------	----------

Protective warning marker; with black high-voltage symbol; for 5 terminal blocks

yellow	280-415	100 (25)
--------	---------	----------

Adjacent jumper; insulated; $I_N = I_N$ terminal block

gray	280-402	200 (25)
yellow-green	280-422	200 (25)

Alternate jumper; insulated; $I_N = I_N$ terminal block

gray	280-409	100 (25)
------	---------	----------

Technical Data

0.08 ... 2.5 mm ²	28 ... 12 AWG*
250 V/4 kV/3 ①	600 V, 15 A I_N
I_N 16 A	300 V, 15 A I_N

Terminal block width: 5 mm / 0.197 inch

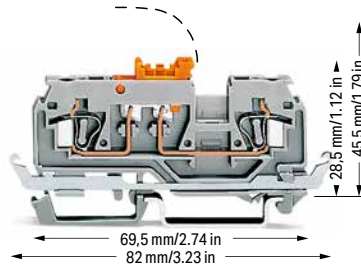
 8 ... 9 mm / 0.31 ... 0.35 inch

2-conductor disconnect/test terminal block; with test port; with pivoting knife disconnect
Gray terminal block housing
Orange disconnect link

Color	Item No.	Pack. Unit
○ gray	280-871	100

Gray terminal block housing
Gray disconnect link

○ gray	280-869	100
--------	---------	-----

Orange terminal block housing
Orange disconnect link

● blue	280-880	100
--------	---------	-----

*12 AWG: THHN, THWN

① 400 V / 250 V = rated voltage
6 kV / 4 kV = rated impulse voltage
3 = pollution degree
(see Section 15)

② Terminal blocks with a blue insulated housing are suitable for Ex i applications.

Please observe the application notes:
Insulation stop, page 382
Jumpers, from page 384
Comb-style jumper bar, page 383
Testing accessories, from page 378
Marking, from page 640

Approvals and corresponding ratings,
visit www.wago.com

Accessories; 280 Series

Appropriate marking systems:
WMB/WMB Inline/WFB

Operating tool; insulated

2-way	280-432	1
3-way	280-433	1

Operating tool; insulated

10-way	280-440	1
--------	---------	---

Test plug module; snaps together; 5 mm wide

gray	280-418	100 (25)
------	---------	----------

Spacer module; snaps together; 5 mm wide

gray	280-419	100 (25)
------	---------	----------

Test plug adapter; 8.3 mm wide; for 4 mm Ø test plug; for 1.5 ... 10 mm² terminal blocks

gray	209-170	50 (25)
------	---------	---------

Test plug adapter; 5 mm wide; for 4 mm Ø test plug; for 1.5 ... 4 mm² terminal blocks

gray	280-404	100 (25)
------	---------	----------

Test plug; with 500 mm cable; 2 mm Ø; max. 42 V

red	210-136	50
-----	---------	----

WMB marking card; white; 10 strips with 10 markers/card; stretchable 5 ... 5.2 mm

plain	793-5501	5
-------	----------	---

Mini-WSB marking card; white; 10 strips with 10 markers/card; 5 mm wide markers

plain	248-501	5
-------	---------	---

4-Conductor Disconnect/Test Terminal Block without/with Shield Contact

2.5 mm²; 280 Series

Technical Data	
0.08 ... 2.5 mm ²	28 ... 12 AWG*
400 V/6 kV/3 ①	600 V, 15 A ②
I _N 16 A	300 V, 15 A ③
Terminal block width: 5 mm / 0.197 inch	
8 ... 9 mm / 0.31 ... 0.35 inch	

Technical Data	
0.08 ... 2.5 mm ²	28 ... 12 AWG*
250 V/4 kV/3 ①	600 V, 15 A ②
I _N 16 A	300 V, 15 A ③
Terminal block width: 5 mm / 0.197 inch	
8 ... 9 mm / 0.31 ... 0.35 inch	

- *12 AWG: THHN, THWN
- 400 V / 250 V = rated voltage
6 kV / 4 kV = rated impulse voltage
3 = pollution degree
(see Section 15)
 - Terminal blocks with a blue insulated housing are suitable for Ex i applications.
- Please observe the application notes:
Insulation stop, page 382
Comb-style jumper bar, page 383
Marking, from page 640
- Approvals and corresponding ratings, visit www.wago.com

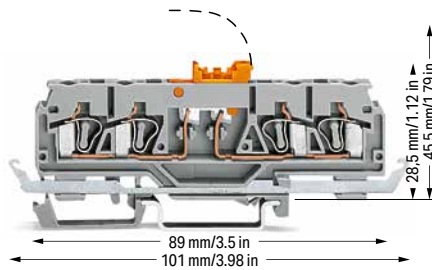
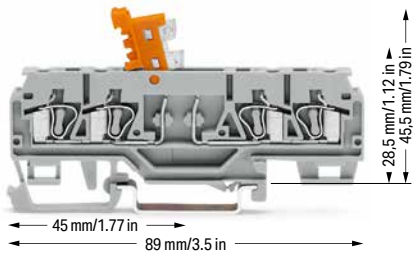

4-conductor disconnect/test terminal block; with test port; with pivoting knife disconnect Gray terminal block housing Orange disconnect link		
Color	Item No.	Pack. Unit
○ gray	280-874	100

4-conductor disconnect/test terminal block; with test port; with pivoting knife disconnect Gray terminal block housing Orange disconnect link		
Color	Item No.	Pack. Unit
○ gray	280-875	100

Gray terminal block housing Gray disconnect link		
Color	Item No.	Pack. Unit
○ gray	280-881	100

Gray terminal block housing Gray disconnect link		
Color	Item No.	Pack. Unit
○ gray	280-882	100

Blue terminal block housing Orange disconnect link		
Color	Item No.	Pack. Unit
● blue	280-885 ②	100

Orange terminal block housing Orange disconnect link		
Color	Item No.	Pack. Unit
● blue	280-884	100

Orange terminal block housing Orange disconnect link		
Color	Item No.	Pack. Unit
● orange	280-883	100

Accessories; 280 Series Appropriate marking systems: WMB/WMB Inline/WFB

End and intermediate plate; 2.5 mm thick		
Color	Item No.	Pack. Unit
orange	280-373	100 (25)
gray	280-376	100 (25)

Alternate comb-style jumper bar; insulated; I _N = I _N of terminal block		
Way	Item No.	Pack. Unit
2-way	280-492	200 (25)

Insulation stop; 0.08 ... 0.2 mm ² "s" (0.14 mm ² "f-st"); 5 pcs/strip		
Color	Item No.	Pack. Unit
white	280-470	200 (25)

Operating tool; insulated		
Way	Item No.	Pack. Unit
2-way	280-432	1
3-way	280-433	1

Insulation stop; 0.25 ... 0.5 mm ² ; 5 pcs/strip		
Color	Item No.	Pack. Unit
light gray	280-471	200 (25)

Operating tool; insulated		
Way	Item No.	Pack. Unit
10-way	280-440	1

Insulation stop; 0.75 ... 1 mm ² ; 5 pcs/strip		
Color	Item No.	Pack. Unit
dark gray	280-472	200 (25)

Test plug; with 500 mm cable; 2 mm Ø; max. 42 V		
Color	Item No.	Pack. Unit
red	210-136	50

Protective warning marker; with black high-voltage symbol; for 5 terminal blocks		
Color	Item No.	Pack. Unit
yellow	280-415	100 (25)

Comb-style jumper bar; insulated; I _N = I _N of terminal block		
Way	Item No.	Pack. Unit
2-way	280-482	200 (25)
3-way	280-483	200 (25)

Comb-style jumper bar; insulated; I _N = I _N of terminal block		
Way	Item No.	Pack. Unit
10-way	280-490	50 (25)

Disconnect/Test Terminal Block; with Disconnect Tab 2.5 mm²; 280 Series

Technical Data	
0.08 ... 2.5 mm ²	28 ... 12 AWG*
400 V/6 kV/3 ⚡	300 V, 15 A VA
I _N 10 A	300 V, 15 A Ⓞ
Terminal block width: 5 mm / 0.197 inch	
8 ... 9 mm / 0.31 ... 0.35 inch	

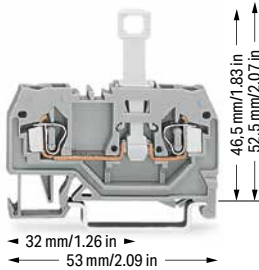

2-conductor disconnect terminal block; with disconnect tab		
Color	Item No.	Pack. Unit
○ gray	280-912	50
● blue	280-914	50
● orange	280-913	50

Other terminal blocks with the same profile:		
Through	280-901	Page 274

Accessories; item-specific			
End and intermediate plate; 2.5 mm thick			
● orange	orange	280-309	100 (25)
● gray	gray	280-308	100 (25)
● light gray	light gray	280-356	100 (25)
Separator; oversized; 2 mm thick			
● orange	orange	280-311	100 (25)
● gray	gray	280-310	100 (25)
● light gray	light gray	280-357	100 (25)

Technical Data	
0.08 ... 2.5 mm ²	28 ... 12 AWG*
400 V/6 kV/3 ⚡	300 V, 15 A VA
I _N 10 A	600 V, 15 A Ⓞ
Terminal block width: 5 mm / 0.197 inch	
8 ... 9 mm / 0.31 ... 0.35 inch	

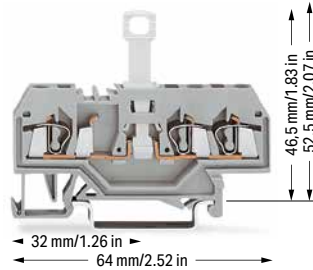

3-conductor disconnect terminal block; with disconnect tab		
Color	Item No.	Pack. Unit
○ gray	280-683	50

Other terminal blocks with the same profile:		
Through	280-681	Page 274

Accessories; item-specific			
End and intermediate plate; 2.5 mm thick			
● orange	orange	280-326	100 (25)
● gray	gray	280-324	100 (25)
● light gray	light gray	280-358	100 (25)
Separator; oversized; 2 mm thick			
● orange	orange	280-346	100 (25)
● gray	gray	280-344	100 (25)
● light gray	light gray	280-359	100 (25)

Technical Data	
0.08 ... 2.5 mm ²	28 ... 12 AWG*
400 V/6 kV/3 ⚡	300 V, 15 A VA
I _N 10 A	600 V, 15 A Ⓞ
Terminal block width: 5 mm / 0.197 inch	
8 ... 9 mm / 0.31 ... 0.35 inch	

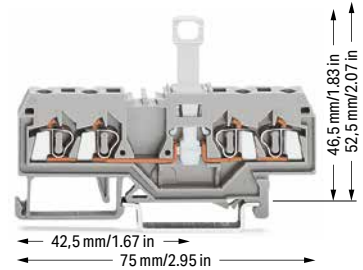

4-conductor disconnect terminal block; with disconnect tab		
Color	Item No.	Pack. Unit
○ gray	280-836	50
● blue	280-839	50
● orange	280-805	50

Other terminal blocks with the same profile:		
Through	280-833	Page 274

Accessories; item-specific			
End and intermediate plate; 2.5 mm thick			
● orange	orange	280-315	100 (25)
● gray	gray	280-314	100 (25)
● light gray	light gray	280-352	100 (25)
Separator; oversized; 2 mm thick			
● orange	orange	280-335	100 (25)
● gray	gray	280-334	100 (25)
● light gray	light gray	280-353	100 (25)

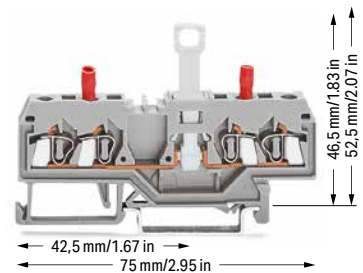

2-conductor disconnect/test terminal block; with disconnect tab; with integrated test sockets		
Color	Item No.	Pack. Unit
○ gray	280-829	50

Accessories; item-specific			
End and intermediate plate; 2.5 mm thick			
● orange	orange	280-315	100 (25)
● gray	gray	280-314	100 (25)
● light gray	light gray	280-352	100 (25)
Separator; oversized; 2 mm thick			
● orange	orange	280-335	100 (25)
● gray	gray	280-334	100 (25)
● light gray	light gray	280-353	100 (25)

6

*12 AWG: THHN, THWN

- ① 400 V = rated voltage
- 6 kV = rated impulse voltage
- 3 = pollution degree (see Section 15)

Please observe the application notes:
 Insulation stop, page 382
 Comb-style jumper bar, page 383
 Marking, from page 640

Approvals and corresponding ratings, visit www.wago.com

Accessories; 280 Series

Appropriate marking systems:
 WMB/WMB Inline/WFB

Insulation stop; 0.08 ... 0.2 mm² "s" (0.14 mm² "f-st"); 5 pcs/strip

	white	280-470	200 (25)
---	-------	---------	----------

Insulation stop; 0.25 ... 0.5 mm²; 5 pcs/strip

	light gray	280-471	200 (25)
---	------------	---------	----------

Insulation stop; 0.75 ... 1 mm²; 5 pcs/strip

	dark gray	280-472	200 (25)
---	-----------	---------	----------

Protective warning marker; with black high-voltage symbol; for 5 terminal blocks

	yellow	280-415	100 (25)
---	--------	---------	----------

Comb-style jumper bar; insulated; I_N = I_N of terminal block

	2-way	280-482	200 (25)
	3-way	280-483	200 (25)
	10-way	280-490	50 (25)

Alternate comb-style jumper bar; insulated; I_N = I_N of terminal block

	2-way	280-492	200 (25)
---	-------	---------	----------

Operating tool; insulated

	2-way	280-432	1
	3-way	280-433	1
	10-way	280-440	1

Disconnect lock; for disconnect tab used on disconnect terminal blocks (280/281 and 769 Series)

	red	709-170	200 (25)
---	-----	---------	----------

Test socket; insulated; 2 mm Ø

	red	209-107	
---	-----	---------	--

Test socket; insulated; 2.3 mm Ø

	yellow	209-108	100 (25)
---	--------	---------	----------

Test plug; with 500 mm cable; 2 mm Ø; max. 42 V

	red	210-136	50
---	-----	---------	----

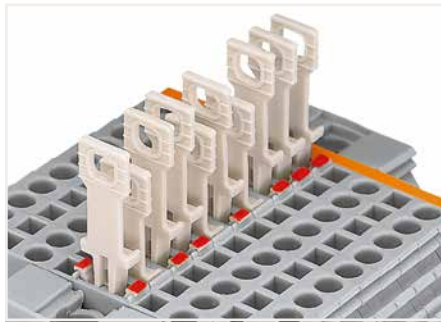

Disconnect terminal block with colored tab to indicate the switching status (red = disconnected)



Commoning front-entry disconnect terminal blocks via comb-style jumper bar using a 10-pole operating tool.

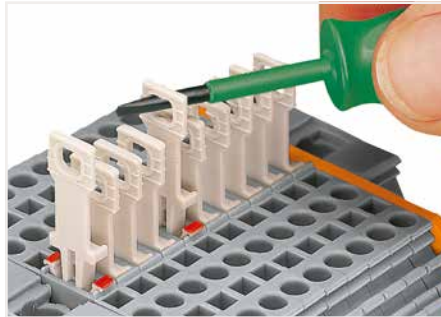

Pulling the disconnect tab via operating tool.



Pulling the disconnect tab by hand.

Disconnect/Test Terminal Block; with Disconnect Tab

4 mm²; 281 Series

Technical Data	
0.08 ... 4 mm ²	28 ... 12 AWG
400 V/6 kV/3 ①	300 V, 15 A ②
I _N 10 A	300 V, 15 A ③
Terminal block width: 6 mm / 0.236 inch	
9 ... 10 mm / 0.35 ... 0.39 inch	

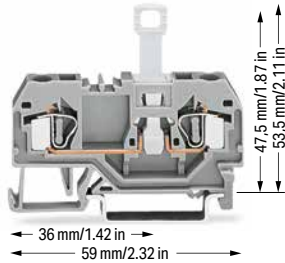

2-conductor disconnect terminal block; with disconnect tab		
Color	Item No.	Pack. Unit
○ gray	281-912	50

Technical Data	
0.08 ... 4 mm ²	28 ... 12 AWG
400 V/6 kV/3 ①	300 V, 15 A ②
I _N 10 A	600 V, 15 A ③
Terminal block width: 6 mm / 0.236 inch	
9 ... 10 mm / 0.35 ... 0.39 inch	

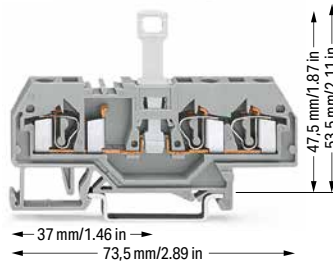

3-conductor disconnect terminal block; with disconnect tab		
Color	Item No.	Pack. Unit
○ gray	281-683	50

Technical Data	
0.08 ... 4 mm ²	28 ... 12 AWG
400 V/6 kV/3 ①	300 V, 15 A ②
I _N 10 A	600 V, 15 A ③
Terminal block width: 6 mm / 0.236 inch	
9 ... 10 mm / 0.35 ... 0.39 inch	

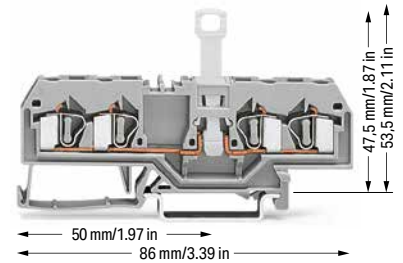

4-conductor disconnect terminal block; with disconnect tab		
Color	Item No.	Pack. Unit
○ gray	281-659	50
● blue	281-660	50

6

Other terminal blocks with the same profile:		
Through	281-901	Page 278

Other terminal blocks with the same profile:		
Through	281-681	Page 278

Other terminal blocks with the same profile:		
Through	281-652	Page 278

Accessories; item-specific			
End and intermediate plate; 2.5 mm thick			
	orange	281-329	100 (25)
	gray	281-328	100 (25)
	light gray	281-349	100 (25)

Accessories; item-specific			
End and intermediate plate; 2.5 mm thick			
	orange	281-326	100 (25)
	gray	281-324	100 (25)
	light gray	281-355	100 (25)

Accessories; item-specific			
End and intermediate plate; 2.5 mm thick			
	orange	281-335	100 (25)
	gray	281-334	100 (25)
	light gray	281-345	100 (25)

Separator; oversized; 2 mm thick			
	orange	281-331	100 (25)
	gray	281-330	100 (25)
	light gray	281-350	100 (25)

Separator; oversized; 2 mm thick			
	orange	281-346	100 (25)
	gray	281-344	100 (25)
	light gray	281-356	100 (25)

Separator; oversized; 2 mm thick			
	orange	281-339	100 (25)
	gray	281-338	100 (25)
	light gray	281-347	100 (25)

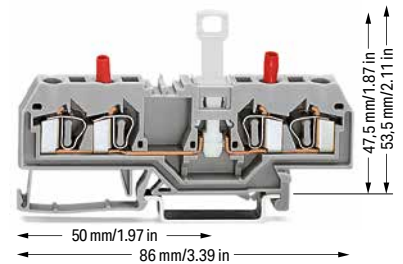

2-conductor disconnect/test terminal block; with disconnect tab; with integrated test sockets		
Color	Item No.	Pack. Unit
○ gray	281-666	50

Accessories; item-specific			
End and intermediate plate; 2.5 mm thick			
	orange	281-335	100 (25)
	gray	281-334	100 (25)
	light gray	281-345	100 (25)
Separator; oversized; 2 mm thick			
	orange	281-339	100 (25)
	gray	281-338	100 (25)
	light gray	281-347	100 (25)

- ① 400 V = rated voltage
6 kV = rated impulse voltage
3 = pollution degree
(see Section 15)

Please observe the application notes:
Insulation stop, page 382
Comb-style jumper bar, page 383
Marking, from page 640

Approvals and corresponding ratings,
visit www.wago.com

Accessories; 281 Series

Appropriate marking systems:
WMB/WMB Inline/WFB

Insulation stop; 0.08 ... 0.2 mm² "s" (0.14 mm² "f-st"); 5 pcs/strip

white	281-470	200 (25)
-------	---------	----------



Insulation stop; 0.25 ... 0.5 mm²; 5 pcs/strip

light gray	281-471	200 (25)
------------	---------	----------



Insulation stop; 0.75 ... 1.5 mm²; 5 pcs/strip

dark gray	281-472	200 (25)
-----------	---------	----------



Protective warning marker; with black high-voltage symbol; for 5 terminal blocks

yellow	281-415	100 (25)
--------	---------	----------



Comb-style jumper bar; insulated; I_N = I_N of terminal block

2-way	281-482	100 (25)
3-way	281-483	100 (25)
5-way	281-485	100 (25)
10-way	281-490	50 (25)



Alternate comb-style jumper bar; insulated; I_N = I_N of terminal block

2-way	281-492	100 (25)
-------	---------	----------



Operating tool; insulated

2-way	280-432	1
3-way	280-433	1
10-way	281-440	1



Disconnect lock; for disconnect tab used on disconnect terminal blocks (280/281 and 769 Series)

red	709-170	200 (25)
-----	---------	----------



Test socket; insulated; 2 mm Ø

red	209-107	
-----	---------	--



Test socket; insulated; 2.3 mm Ø

yellow	209-108	100 (25)
--------	---------	----------



Test plug; with 500 mm cable; 2 mm Ø; max. 42 V

red	210-136	50
-----	---------	----

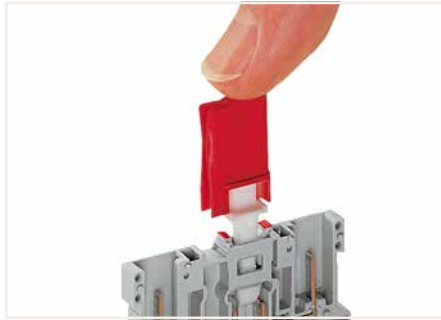

Installing a disconnect lock on the terminal block's disconnect tab (picture shows a 2-pin disconnect carrier terminal block, 769 Series).



Unlocking a disconnect lock.



Removing a disconnect lock.

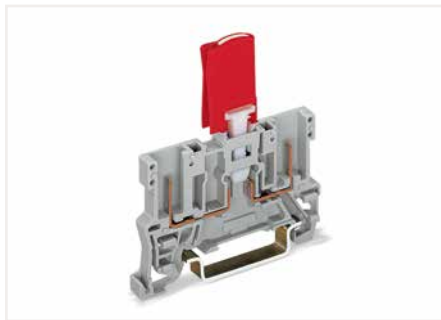

Double Safety:

The disconnect tab has been designed for maximum operational safety.

As soon as the disconnect tab is in the disconnect position, it can be protected against unintentional reconnection by using the disconnect lock. Only through intentional and focused use of a tool, can the disconnect lock be removed and the circuit reconnected.

Features/Benefits:

- Easy to use
- Install/remove disconnect lock with just one hand
- Clearly identify disconnect tab position
- Higher safety
- Intentional effort is required to reconnect the circuit

Disconnect/Test Terminal Blocks; for Current and Voltage Transformer Circuits

282 Series

Description and Installation

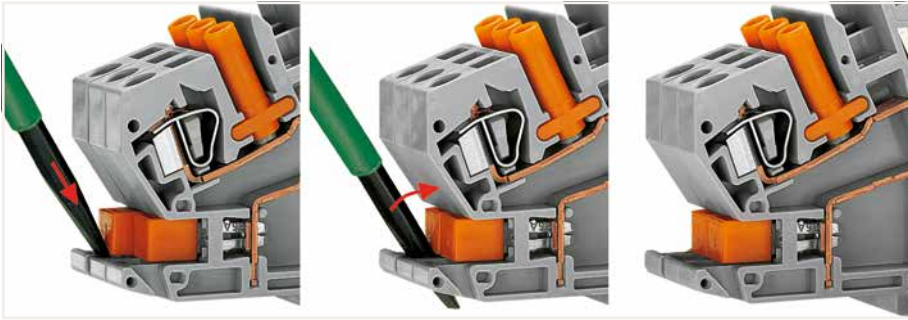

Inserting an insulated, touch-proof adjacent jumper into the protected shorting position.



Terminal strip permanently prepared for current transformer circuits.

6



Lock-out snaps into one of two notched positions, preventing accidental operation of the disconnect link.



Snapping a transparent locking cover onto 1-8 disconnect links:
 a) Mechanically lock several links for multi-pole switching applications
 b) Protect markers

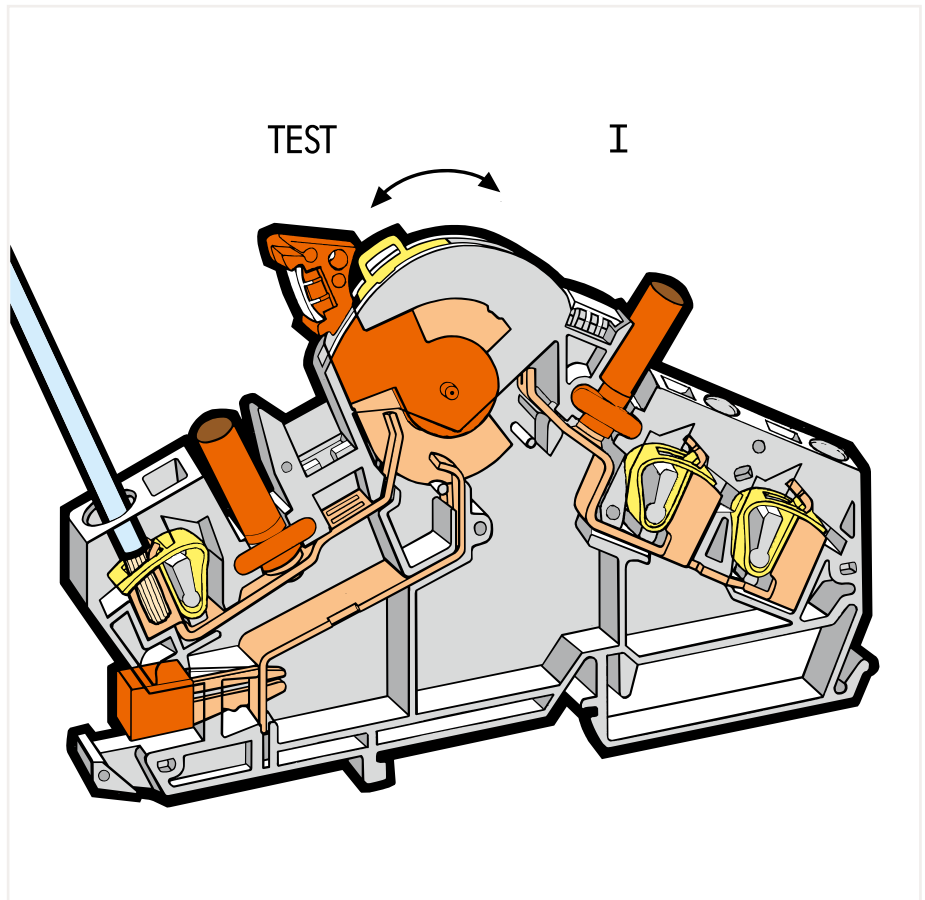

Interlocking link mechanically locks multiple links for multi-pole switching applications.



Touch-proof test sockets for touch-proof 4 mm Ø test plugs (not available from WAGO, but are offered by industry suppliers such as, Fabrikat Multi-Contact)



Labeling via WMB Multi Marking System.



CAGE CLAMP® terminates the following copper conductors: solid "s"



stranded "st"



fine-stranded "f-st", also with tinned single strands

With ferruled conductors, it is necessary to use a terminal block one size smaller than the conductor's nominal cross section.



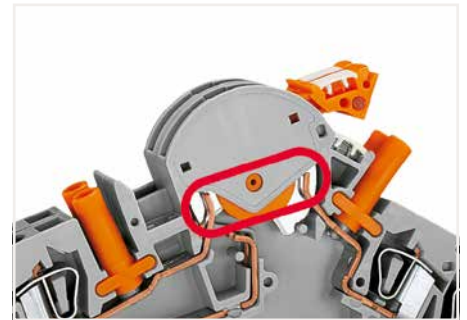
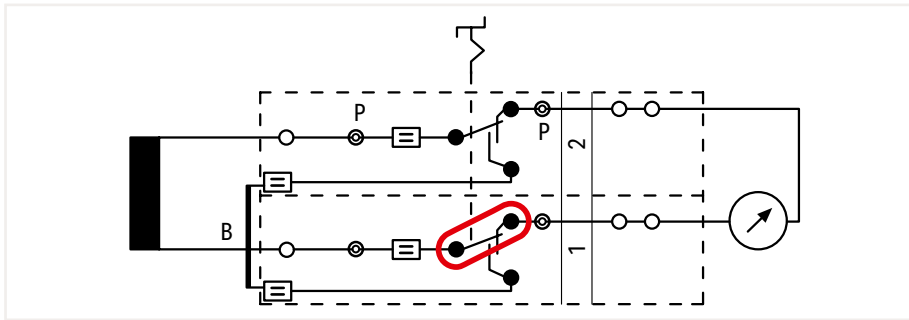

Disconnect link in notched "I" position
In "I" operating position, the measurement device is connected to the transformer.

B = shorting jumper, P = test socket

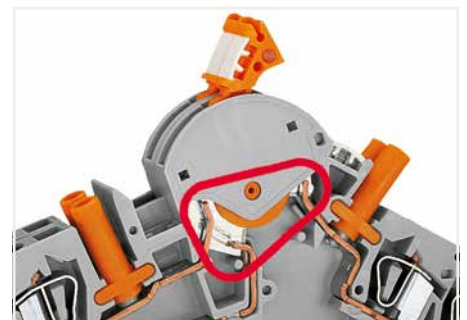
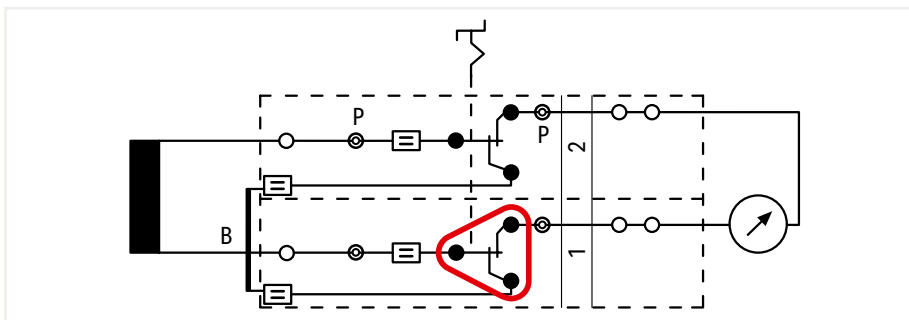

Disconnect link in transition from "I" to "TEST" (terminal blocks 1 + 2)
The transformer is not disconnected from the measurement device, yet the shorting path is activated by moving the disconnect link from "I" to "TEST."

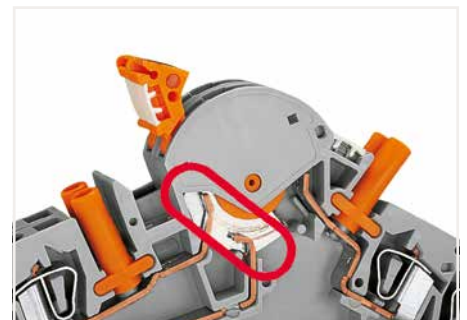
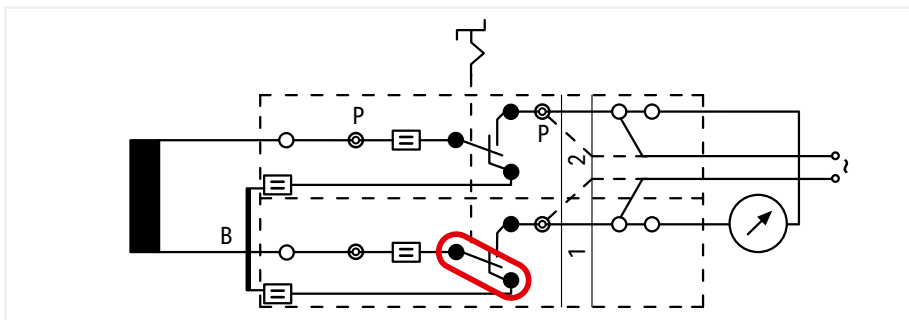

Disconnect link in notched "TEST" position (terminal blocks 1 + 2)
The measurement device/relay is electrically disconnected from the transformer. If required, external voltage can be applied to the measurement device/relay via the test socket, or the 2nd CAGE CLAMP® connection.

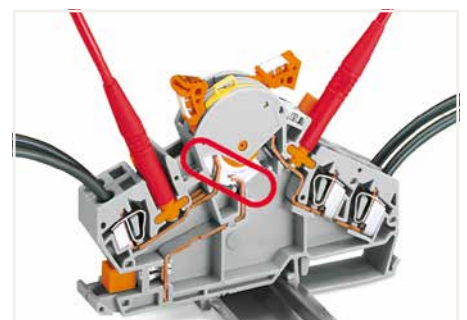
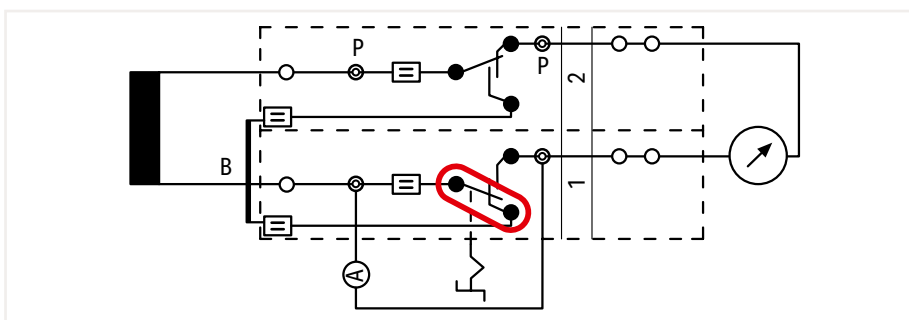

Disconnect link in notched position "I" (terminal block 2) Disconnect link in notched position "TEST" (terminal block 1) – measurement testing
Before moving the disconnect link of terminal block 1 into the notched "TEST" position, the reference current meter must be inserted into the test socket of terminal block 1.



fine-stranded,
tip-bonded



fine-stranded,
with ferrule
(gastight crimped)



fine-stranded,
with pin terminal
(gastight crimped)

Circuit Configuration Examples

6

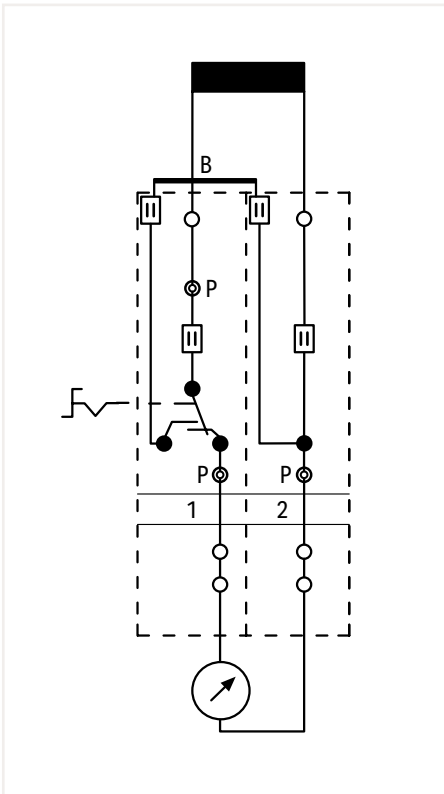

Measuring set for a single-phase current transformer (without measurement testing)



Terminal blocks required:

- 1 x disconnect/test terminal block (282-870)
- 1 x through terminal block (282-865)
- 1 x jumper, orange (282-424)
- 1 x end plate, orange (282-386)
- In addition: locking cover, lock-out

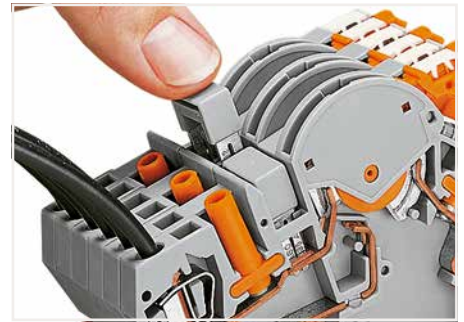

Additional commoning possible with circuit-related adjacent jumpers or testing option via test plug adapter (209-170) on transformer side.

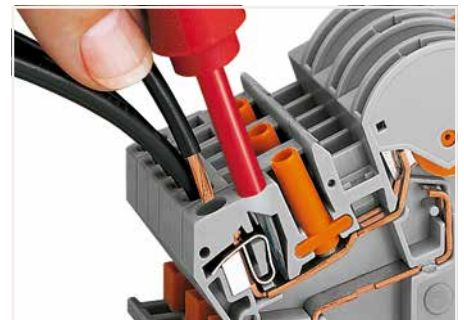

CAGE CLAMP® connection

Inserting a conductor via operating tool (5.5 x 0.8 mm blade).

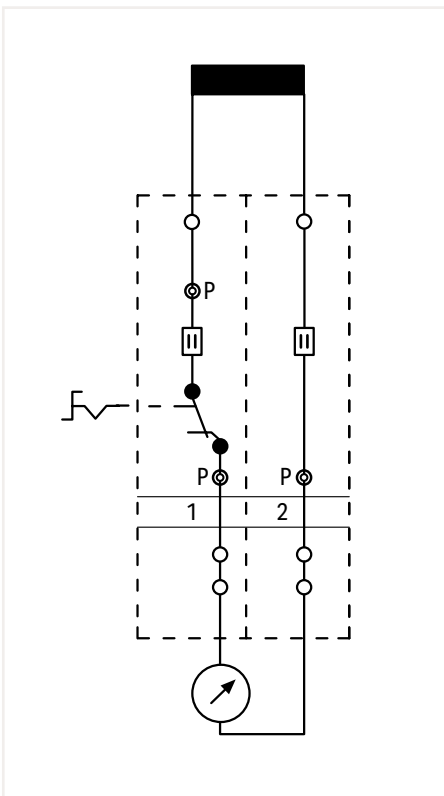

Measuring set for a single-phase voltage transformer



Terminal blocks required:

- 1 x disconnect/test terminal block (282-860)
- 1 x through terminal block (282-866)
- 1 x end plate, orange (282-386)
- In addition: locking cover, lock-out



A lock-out seal can be used on the disconnect link in notched "I" position.



Additional CAGE CLAMP® connection on the measurement device side, e.g., when connecting wire commoning chains or applying an external voltage.

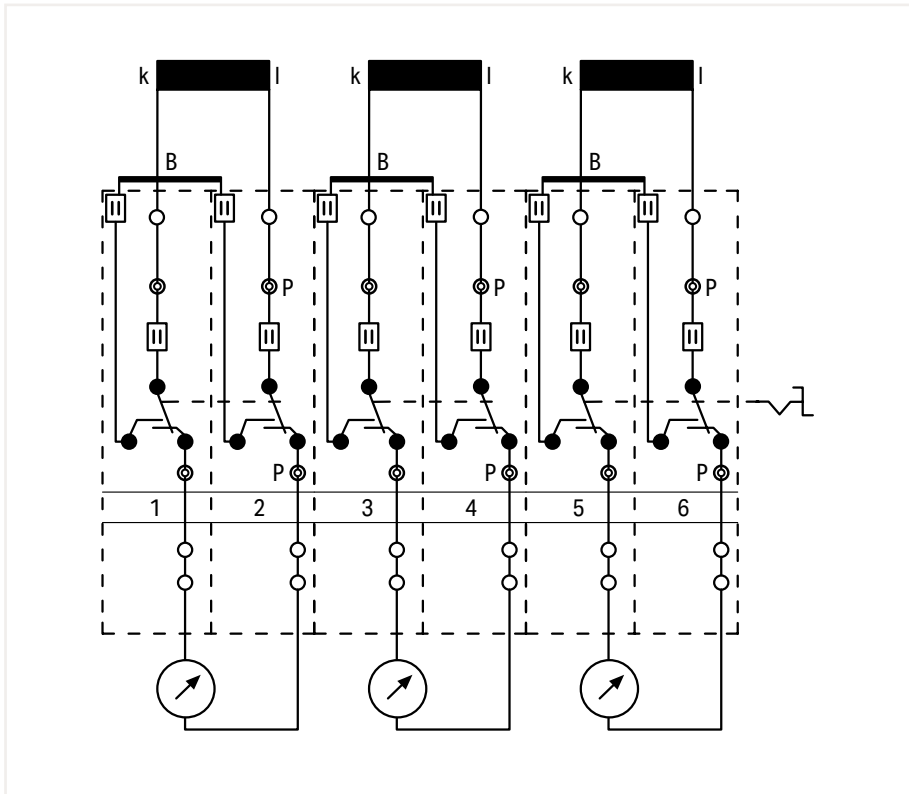

Measuring set for a three-phase current transformer

Pairs of disconnect links are interconnected via interlocking link or locking cover. Measurement testing is performed after the interlocking is released.

B = shorting jumper, P = test socket

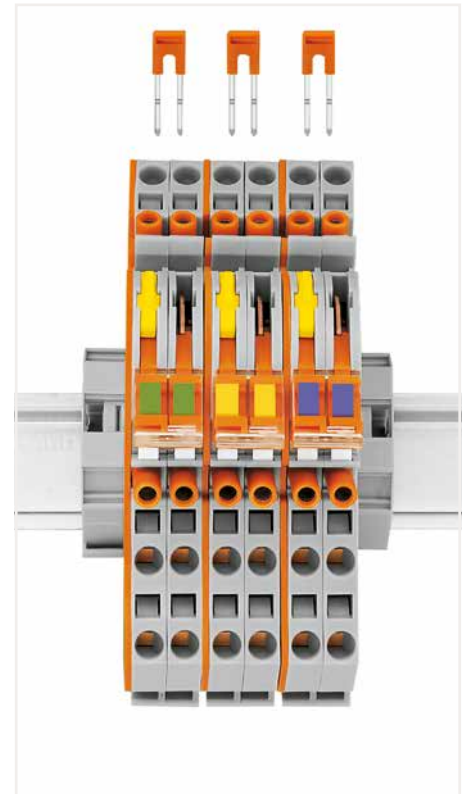

Terminal blocks required:

- 6 x disconnect/test terminal block (282-870)
- 3 x jumper, orange (282-424)
- 3 x end plate, orange (282-386)
- In addition: interlocking link, locking cover, lock-out

6

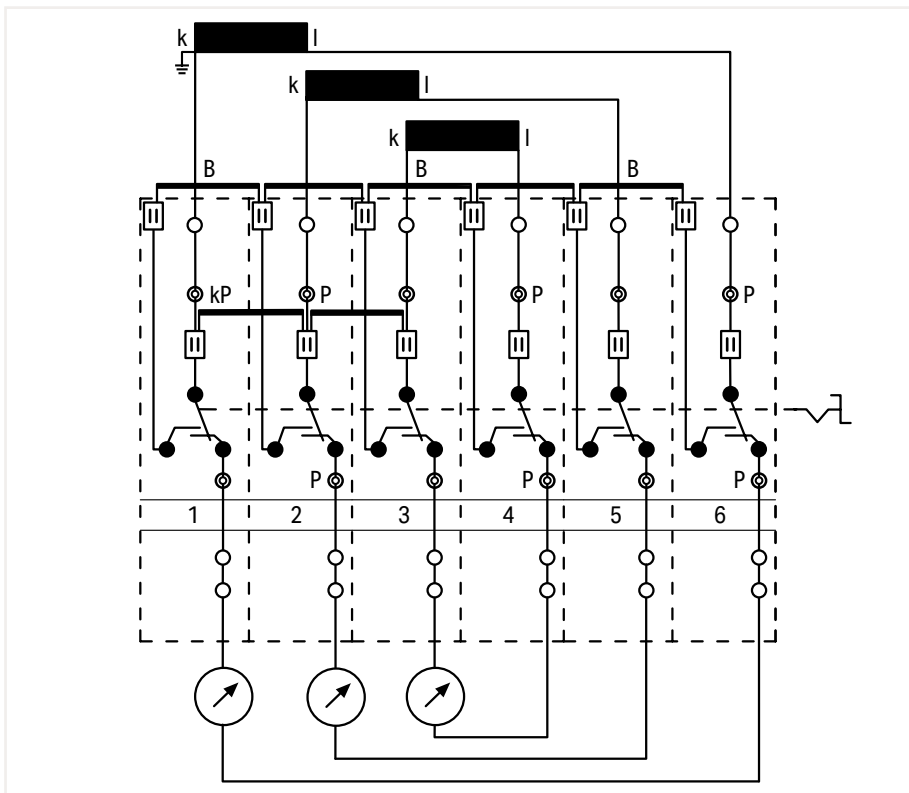

Measuring set for a three-phase current transformer with 'Y' point

All six disconnect links are interconnected via interlocking link.

kP = 'Y' point jumper

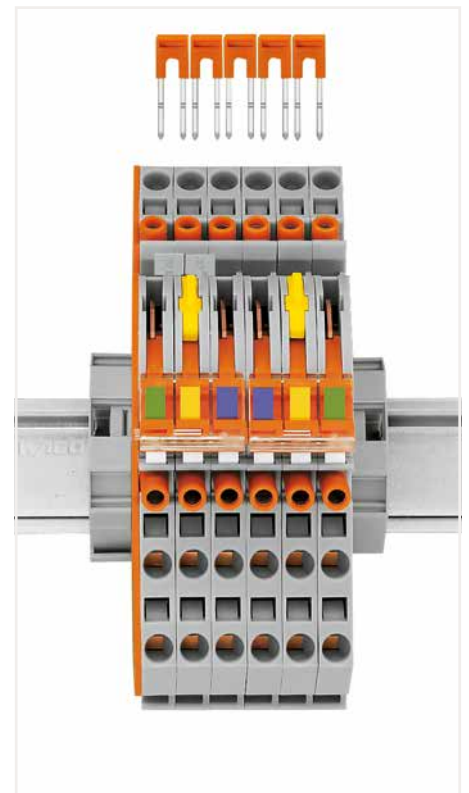

Terminal blocks required:

- 6 x disconnect/test terminal block (282-870)
- 5 x jumper, orange (282-424)
- 2 x jumper, gray (282-402)
- 1 x end plate, orange (282-386)
- In addition: interlocking link, locking cover, lock-out

Disconnect/Test Terminal Block, Through/Ground Conductor Terminal Block; for Current and Voltage Transformer Circuits 6 mm²; 282 Series

Technical Data	
0.2 ... 6 mm ²	24 ... 10 AWG
500 V/6 kV/3 ①	600 V, 30 A ②
I _N 30 A	300 V, 5 A ③
Terminal block width: 8 mm / 0.315 inch	
12 ... 13 mm / 0.47 ... 0.51 inch	

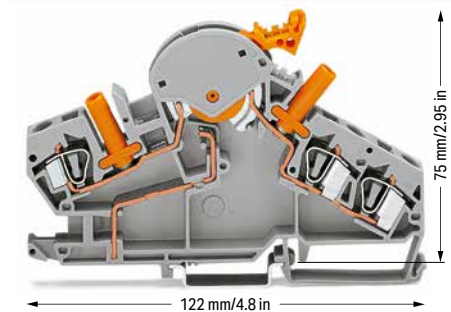

Disconnect/test terminal block; with touch-proof test sockets; for 4 mm Ø test plugs; e.g., for current transformer circuits; orange disconnect link

Color	Item No.	Pack. Unit
○ gray	282-870 ② ③	20

Accessories; item-specific			
End and separator plate; 1.5 mm thick; without lock-out seal option			
	orange	282-386	50 (10)
	gray	282-391	50 (10)

End and separator plate; 1.5 mm thick; with lock-out seal option			
	orange	282-387	50 (10)
	gray	282-392	50 (10)

Lock-out device; for disconnect link			
	yellow	282-384	100 (20)

Locking cover; mechanically locks multiple links; transparent			
	1-pole	282-881	50 (10)
	2-pole	282-882	50 (10)
	3-pole	282-883	50 (10)
	4-pole	282-884	50 (10)
	5-pole	282-885	50 (10)
	6-pole	282-886	50 (10)
	7-pole	282-887	50 (10)
	8-pole	282-888	50 (10)

Interlocking link; mechanically locks multiple links; 1 m long			
	transparent	210-254	1

Adjacent jumper; insulated; I _N 41 A			
	orange	282-424	100 (25)

WMB marking card; 10 strips with 10 markers/card; stretchable 5 ... 5.2 mm; yellow			
	k/l (50x)	794-5553/000-002	5

Technical Data	
0.2 ... 6 mm ²	24 ... 10 AWG
500 V/6 kV/3 ①	600 V, 30 A ②
I _N 30 A	300 V, 5 A ③
Terminal block width: 8 mm / 0.315 inch	
12 ... 13 mm / 0.47 ... 0.51 inch	

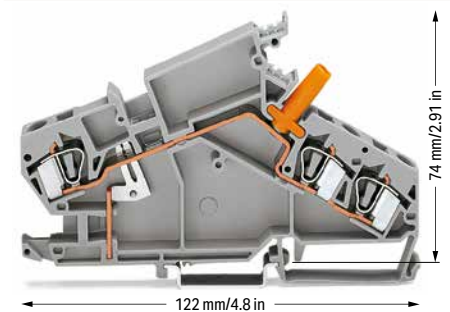

Through terminal block; with touch-proof test socket; for 4 mm Ø test plugs; e.g., for current transformer circuits

Color	Item No.	Pack. Unit
○ gray	282-865 ③	20

Accessories; item-specific			
End and intermediate plate; 1.5 mm thick			
	orange	282-385	50 (10)
	gray	282-390	50 (10)

WMB marking card; 10 strips with 10 markers/card; stretchable 5 ... 5.2 mm; yellow			
	k/l (50x)	794-5553/000-002	5

Adjacent jumper; insulated; I _N 41 A			
	orange	282-424	100 (25)

Technical Data	
0.2 ... 6 mm ²	24 ... 10 AWG
500 V/6 kV/3 ①	600 V, 30 A ②
I _N 30 A	300 V, 5 A ③
Terminal block width: 8 mm / 0.315 inch	
12 ... 13 mm / 0.47 ... 0.51 inch	

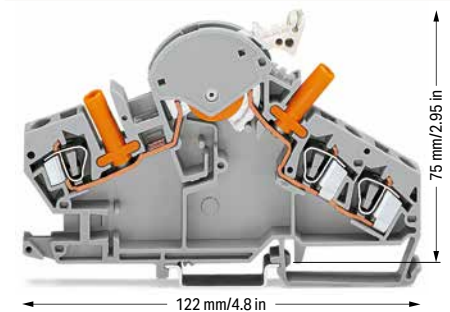

Disconnect/test terminal block; with touch-proof test sockets; for 4 mm Ø test plugs; e.g., for voltage transformer circuits; light gray disconnect link

Color	Item No.	Pack. Unit
○ gray	282-860 ② ③	20

Accessories; item-specific			
End and separator plate; 1.5 mm thick; without lock-out seal option			
	orange	282-386	50 (10)
	gray	282-391	50 (10)

End and separator plate; 1.5 mm thick; with lock-out seal option			
	orange	282-387	50 (10)
	gray	282-392	50 (10)

Lock-out device; for disconnect link			
	yellow	282-384	100 (20)

Locking cover; mechanically locks multiple links; transparent			
	1-pole	282-881	50 (10)
	2-pole	282-882	50 (10)
	3-pole	282-883	50 (10)
	4-pole	282-884	50 (10)
	5-pole	282-885	50 (10)
	6-pole	282-886	50 (10)
	7-pole	282-887	50 (10)
	8-pole	282-888	50 (10)

Interlocking link; mechanically locks multiple links; 1 m long			
	transparent	210-254	1

WMB marking card; 10 strips with 10 markers/card; stretchable 5 ... 5.2 mm; blue			
	U/V (50x)	794-5554/000-006	5

6

Technical Data

0.2 ... 6 mm ²	24 ... 10 AWG
500 V/6 kW/3 ①	600 V, 30 A ②
I _N 30 A	300 V, 5 A ③
Terminal block width: 8 mm / 0.315 inch	
12 ... 13 mm / 0.47 ... 0.51 inch	

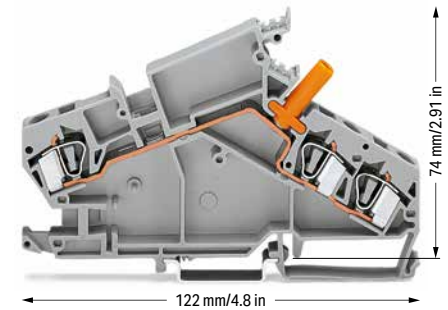

Through terminal block; with touch-proof test socket; for 4 mm Ø test plugs; e.g., for voltage transformer circuits

Color	Item No.	Pack. Unit
○ gray	282-866 ④	20

Accessories; item-specific

End and intermediate plate; 1.5 mm thick

	orange	282-385	50 (10)
	gray	282-390	50 (10)

WMB marking card; 10 strips with 10 markers/card; stretchable 5 ... 5.2 mm; blue

	U/V (50x)	794-5554/000-006	5
--	-----------	------------------	---

Technical Data

0.2 ... 6 mm ²	24 ... 10 AWG
Terminal block width: 8 mm / 0.315 inch	
12 ... 13 mm / 0.47 ... 0.51 inch	

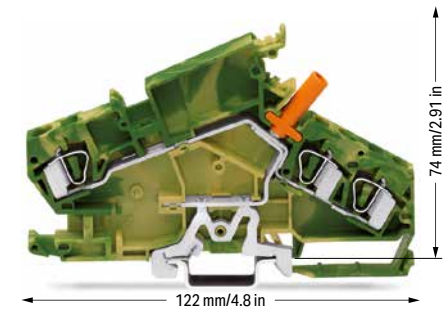

Ground conductor terminal block; with touch-proof test socket; for 4 mm Ø test plugs; e.g., for voltage transformer circuits

Color	Item No.	Pack. Unit
○ gray	282-868 ⑤	20

Accessories; item-specific

End and intermediate plate; 1.5 mm thick

	orange	282-385	50 (10)
	gray	282-390	50 (10)

① 500 V = rated voltage
6 kV = rated impulse voltage
3 = pollution degree
(see Section 15)

② Max. height when rotating the disconnect link (incl. locking cover): 92 mm/3.62 inch

③ For operating stickers, please refer to our online catalog:
• for 282-870: Item No. 210-412
• for 282-865: Item No. 210-415
• for 282-860: Item No. 210-414
• for 282-866: Item No. 210-413

Approvals and corresponding ratings, visit www.wago.com

Accessories; 282 Series

Appropriate marking systems:
WMB/WMB Inline/WFB

Protective warning marker; with black high-voltage symbol; for 5 terminal blocks

	yellow	282-415	100 (25)
--	--------	---------	----------

Adjacent jumper; insulated; I_N 41 A

	gray	282-402	100 (25)
	yellow-green	282-422	100 (25)

Alternate jumper; insulated; I_N 41 A

	gray	282-409	100 (25)
--	------	---------	----------

Wire commoning chain; insulated; 4 connections; 3 x 110 mm; I_N 24 A

	black	709-110	1
--	-------	---------	---

Wire commoning chain; insulated; 3 connections; 2 x 120 mm; I_N 24 A

	black	709-111	1
--	-------	---------	---

Wire commoning chain; insulated; 3 connections; 2 x 170 mm; I_N 24 A

	black	709-112	1
--	-------	---------	---

Group marker carrier; e.g., for 282 Series; angled

	gray	209-144	50 (25)
--	------	---------	---------

WMB marking card; white; 10 strips with 10 markers/card; for 5 ... 17.5 mm terminal block width

	plain	793-501	5
--	-------	---------	---

Transverse Switching Terminal Blocks and Longitudinal Switching Disconnect Terminal Blocks

282 Series

Description and Installation



Transverse switching terminal blocks
Left: Adjacent jumper for commoning of switching lever
Right: Commoning with orange jumper

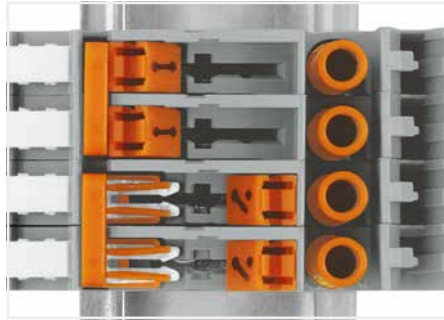

Switch positions
Left: closed
Right: open

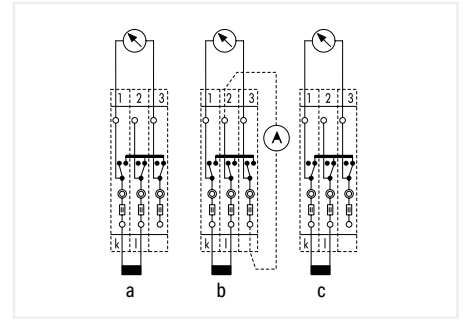

Current transformer circuit with transverse switching terminal blocks
a = Normal operation b = Transformer short circuit
c = Transformer short circuit



Testing via touch-proof 4 mm Ø test plugs (not available from WAGO, but offered by industry suppliers such as, Multi-Contact Deutschland GmbH).

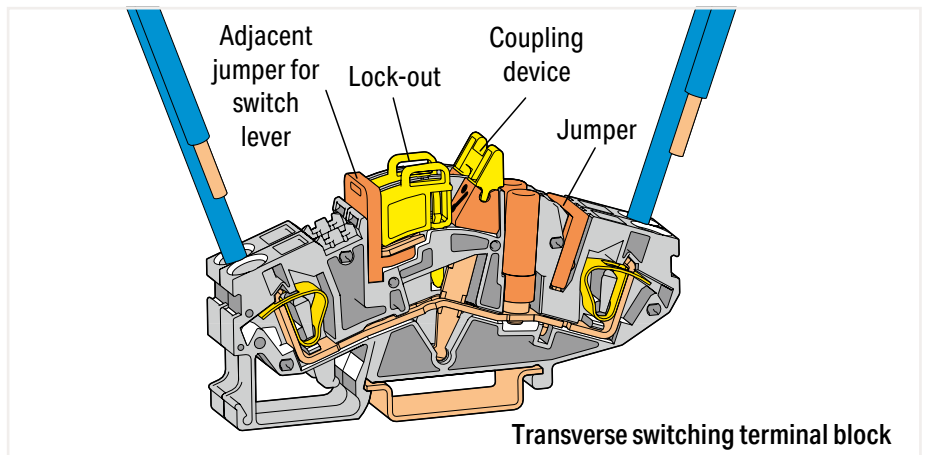

CAGE CLAMP® connection
Inserting a conductor.

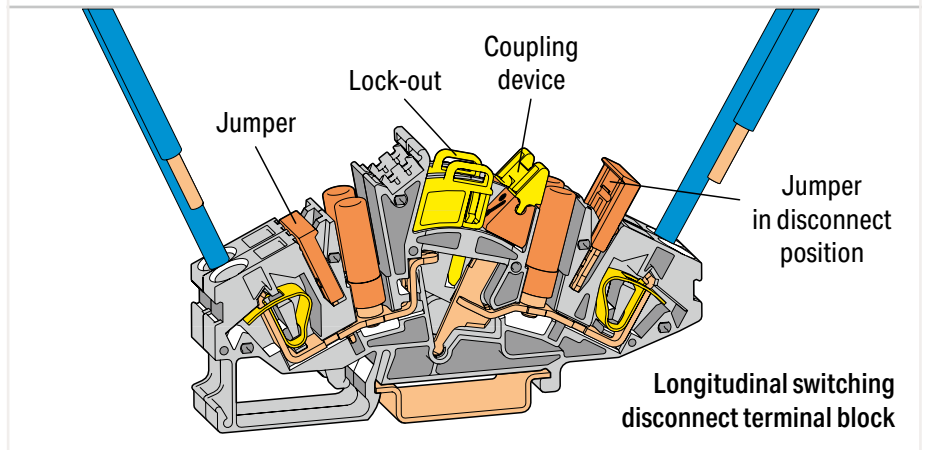

Inserting a lock-out.



Longitudinal switching disconnect terminal blocks

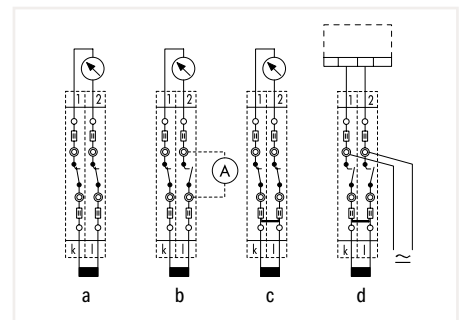

Current transformer circuit with longitudinal switching disconnect terminal blocks
a = Normal operation b = Measured value test
c = Transformer short circuit d = Relay test



CAGE CLAMP® terminates the following copper conductors:
solid "s"



stranded "st"



fine-stranded "f-st",
also with tinned
single strands

Jumpers with Safety Lid; for Longitudinal Switching Disconnect Terminal Blocks 282 Series

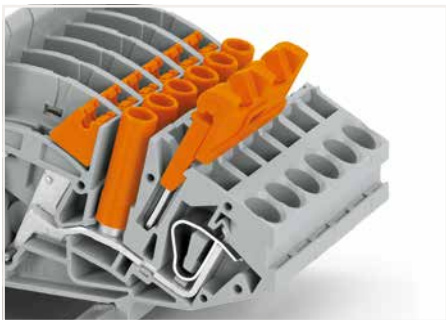

Jumper with safety lid
Jumper in pre-locked position

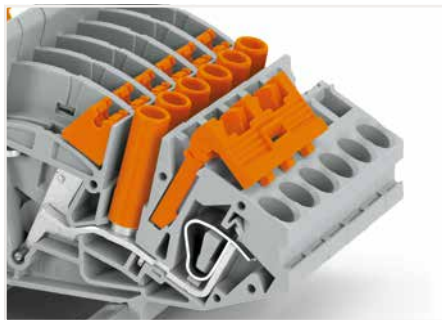

Jumper with safety lid
Longitudinal switching disconnect terminal blocks with
inserted jumper, including safety lid



Jumper with safety lid
Jumper with raised safety lid

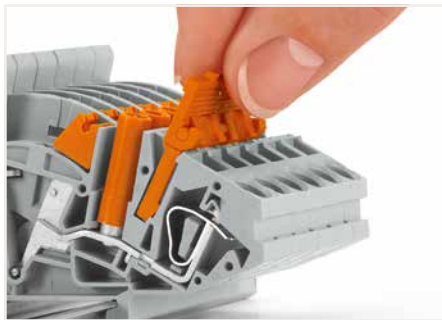

Jumper with safety lid
Removing a jumper via safety lid.



fine-stranded,
tip-bonded



fine-stranded,
with ferrule
(gastight crimped)



fine-stranded,
with pin terminal
(gastight crimped)

Transverse Switching Terminal Block, Longitudinal Switching Disconnect Terminal Block and Through Terminal Block (e.g., for Current Transformer Circuits) 6 mm²; 282 Series

Technical Data	
0.2 ... 6 mm ²	24 ... 10 AWG
500 V/6 kV/3 ①	600 V, 30 A VA
I _N 30 A	300 V, 36 A Ⓢ
Terminal block width: 8 mm / 0.315 inch	
12 ... 13 mm / 0.47 ... 0.51 inch	

Technical Data	
0.2 ... 6 mm ²	24 ... 10 AWG
500 V/6 kV/3 ①	600 V, 30 A VA
I _N 30 A	300 V, 36 A Ⓢ
Terminal block width: 8 mm / 0.315 inch	
12 ... 13 mm / 0.47 ... 0.51 inch	

Technical Data	
0.2 ... 6 mm ²	24 ... 10 AWG
500 V/6 kV/3 ①	600 V, 30 A VA
I _N 30 A	300 V, 36 A Ⓢ
Terminal block width: 8 mm / 0.315 inch	
12 ... 13 mm / 0.47 ... 0.51 inch	

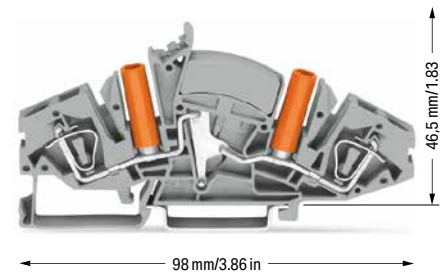
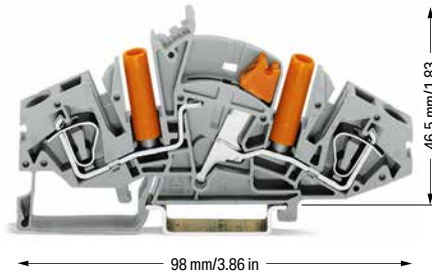
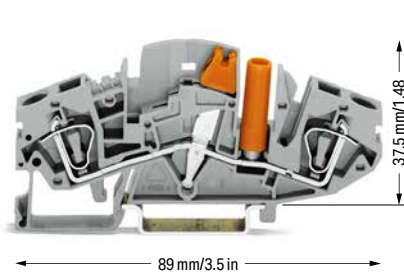

2-conductor disconnect/test terminal block; transverse switching; with touch-proof test socket; for 4 mm Ø test plug

Color	Item No.	Pack. Unit
○ gray	282-811 ②	20

2-conductor disconnect/test terminal block; longitudinal switching; with touch-proof test sockets; for 4 mm Ø test plugs



Color	Item No.	Pack. Unit
○ gray	282-821 ②	20

2-conductor through terminal block; with touch-proof test sockets; for 4 mm Ø test plugs

Color	Item No.	Pack. Unit
○ gray	282-841	20



Accessories; item-specific

End and separator plate; 1.5 mm thick

 orange	282-366	50 (10)
 gray	282-361	50 (10)



Accessories; item-specific

End and separator plate; 1.5 mm thick

 orange	282-365	50 (10)
 gray	282-360	50 (10)

Accessories; item-specific

End and separator plate; 1.5 mm thick

 orange	282-365	50 (10)
 gray	282-360	50 (10)



Lock-out device; for disconnect link

 yellow	282-370	100 (25)
--	---------	----------



Lock-out device; for disconnect link

 yellow	282-370	100 (25)
--	---------	----------





Coupling device; mechanically locks multiple links; yellow

 2-way	282-372	50 (10)
 3-way	282-373	50 (10)
 4-way	282-374	50 (10)

Coupling device; mechanically locks multiple links; yellow

 2-way	282-372	50 (10)
 3-way	282-373	50 (10)
 4-way	282-374	50 (10)

Adjacent jumper for switching lever; insulated; I_N 30 A; orange

 2-way	282-442	50 (10)
 3-way	282-443	50 (10)
 4-way	282-444	50 (10)
 5-way	282-445	50 (10)
 6-way	282-446	50 (10)











Accessories; 282 Series

Appropriate marking systems: WMB/WMB Inline/WFB

Protective warning marker; with black high-voltage symbol; for 5 terminal blocks

 yellow	282-415	100 (20)
--	---------	----------









Jumper; insulated; I_N 30 A; orange

 1-3	282-433/011-000	50 (10)
 1-3-5	282-435/011-000	50 (10)
 1-4-5	282-435/301-000	50 (10)
 1-3-4-5	282-435/300-000	50 (10)
 1-2-4-6	282-436/301-000	50 (10)
 1-4-6	282-436/304-000	50 (10)
 1-3-5-7	282-437/011-000	50 (10)
 1-4-7	282-437/012-000	50 (10)
 1-2-5-8	282-438/300-000	50 (10)
 1-4-7-8	282-438/301-000	50 (10)
 1-3-5-7-9	282-439/011-000	50 (10)

WMB marking card; 10 strips with 10 markers/card; stretchable 5 ... 5.2 mm; yellow

 k/I (50x)	794-5553/000-002	5
---	------------------	---



Jumper; insulated; I_N 30 A; orange

 2-way	282-432	50 (10)
 3-way	282-433	50 (10)
 4-way	282-434	50 (10)
 5-way	282-435	50 (10)
 6-way	282-436	50 (10)
 7-way	282-437	50 (10)
 8-way	282-438	50 (10)
 9-way	282-439	50 (10)
 10-way	282-440	50 (10)

WMB marking card; 10 strips with 10 markers/card; stretchable 5 ... 5.2 mm; blue

 U/V (50x)	794-5554/000-006	5
---	------------------	---

Jumper with safety lid; insulated; I_N 30 A; orange

 2-way	282-432/100-000	50 (10)
 3-way	282-433/100-000	50 (10)
 4-way	282-434/100-000	50 (10)

Collective jumper carrier; for DIN-35 rail; compatible with jumpers for transverse switching terminal block (282-811) and longitudinal switching disconnect terminal block (282-821)

 gray	282-369	25
--	---------	----

WMB marking card; white; 10 strips with 10 markers/card; stretchable 5 ... 5.2 mm

 plain	793-5501	5
---	----------	---

Technical Data0.2 ... 6 mm² | 24 ... 10 AWG

500 V/6 kV/3 ①

I_N 30 A

Terminal block width: 8 mm / 0.315 inch

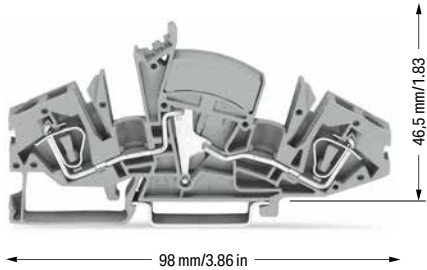
 12 ... 13 mm / 0.47 ... 0.51 inch

- ① 500 V = rated voltage
6 kV = rated impulse voltage
3 = pollution degree
(see Section 15)
- ② Max. height when rotating the disconnect link (incl. locking cover): 45 mm / 1.77 inch
For operating stickers, please refer to our online catalog:
• for 282-811: Item No. 210-424
• for 282-821: Item No. 210-423

Approvals and corresponding ratings,
visit www.wago.com

2-conductor through terminal block; without test sockets



Color	Item No.	Pack. Unit
○ gray	282-841/049-000	20



Accessories; item-specific

End and separator plate; 1.5 mm thick

	orange	282-365	50 (10)
	gray	282-360	50 (10)

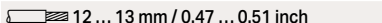
Disconnect Terminal Block and Ground Conductor Disconnect Terminal Block and Through Terminal Block of Same Profile 6 mm²; 282 Series

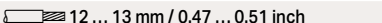

Technical Data	
0.2 ... 6 mm ²	24 ... 10 AWG
400 V/6 kV/3 	600 V, 30 A 
I _N 30 A	300 V, 35 A 
Terminal block width: 8 mm / 0.315 inch	
 12 ... 13 mm / 0.47 ... 0.51 inch	

Technical Data	
0.2 ... 6 mm ²	24 ... 10 AWG
800 V/8 kV/3 	600 V, 30 A 
I _N 41 A	600 V, 35 A 
Terminal block width: 8 mm / 0.315 inch	
 12 ... 13 mm / 0.47 ... 0.51 inch	

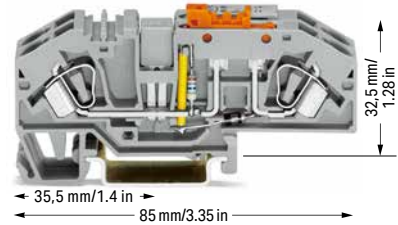
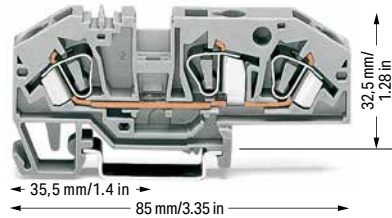
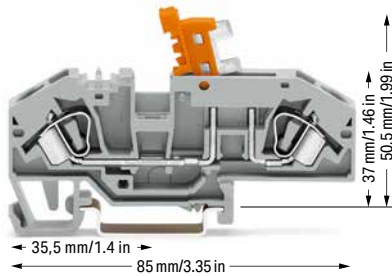

Technical Data	
0.2 ... 6 mm ²	24 ... 10 AWG
Terminal block width: 16 mm / 0.63 inch	
 12 ... 13 mm / 0.47 ... 0.51 inch	







2-conductor disconnect terminal block; with test point; orange disconnect link

Color	Item No.	Pack. Unit
 gray	282-697	25
 blue	282-695	25

3-conductor through terminal block; with test point; same profile as disconnect terminal blocks

Color	Item No.	Pack. Unit
 gray	282-699	25
 blue	282-694	25

Ground conductor disconnect terminal block; with test point; orange disconnect link; gray

	Item No.	Pack. Unit
 24 V	282-640	12
 48 V	282-641	12
 120 V	282-638	12
 230 V	282-639	12

Other terminal blocks with the same profile:

Through	282-699	Page 328
---------	---------	----------

Other terminal blocks with the same profile:

Disconnect	282-697	Page 328
Ground cond. disc.	282-640	Page 328
Fuse	282-696	Page 330

Other terminal blocks with the same profile:

Through	282-699	Page 328
---------	---------	----------

Accessories; item-specific

Adjacent jumper; insulated; I_N 41 A

	gray	282-402	100 (25)
---	------	---------	----------

Accessories; item-specific

Adjacent jumper; insulated; I_N 41 A

	gray	282-402	100 (25)
---	------	---------	----------

Alternate jumper; insulated; I_N 41 A

	gray	282-409	100 (25)
---	------	---------	----------

Alternate jumper; insulated; I_N 41 A

	gray	282-409	100 (25)
---	------	---------	----------

Test plug adapter; 8.3 mm wide; for 4 mm Ø test plug; for 1.5 ... 10 mm² terminal blocks

	gray	209-170	50 (25)
---	------	---------	---------

Test plug adapter; 8.3 mm wide; for 4 mm Ø test plug; for 1.5 ... 10 mm² terminal blocks

	gray	209-170	50 (25)
---	------	---------	---------

B-type test plug module; snaps together; 8 mm wide

	gray	709-310	100 (25)
---	------	---------	----------

B-type test plug module; snaps together; 8 mm wide

	gray	709-310	100 (25)
---	------	---------	----------

B-type spacer module; snaps together; 5 mm wide

	gray	709-311	100 (25)
---	------	---------	----------

B-type spacer module; snaps together; 5 mm wide

	gray	709-311	100 (25)
---	------	---------	----------

Accessories; 282 Series

Appropriate marking systems: WMB/WMB Inline/WFB

End plate; 2 mm thick

	orange	282-333	100 (25)
	gray	282-334	100 (25)

Protective warning marker; with black high-voltage symbol; for 5 terminal blocks

	yellow	282-415	100 (25)
--	--------	---------	----------

① 400 V / 800 V = rated voltage
 6 kV / 8 kV = rated impulse voltage
 3 = pollution degree
 (see Section 15)

Approvals and corresponding ratings,
 visit www.wago.com



Ground conductor disconnect terminal block – top view

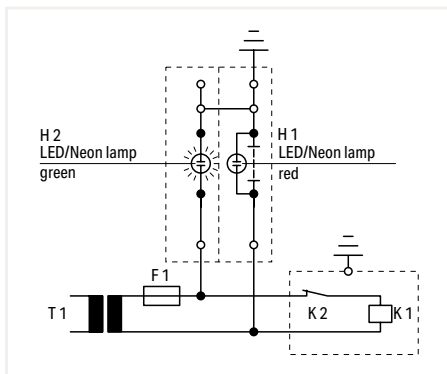

Operating condition
 Slide link closed, auxiliary circuit grounded,
 green LED/neon lamp illuminates.

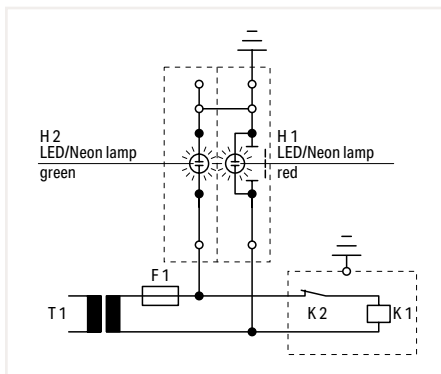

Test condition – no grounding
 Slide link open, auxiliary circuit not grounded.

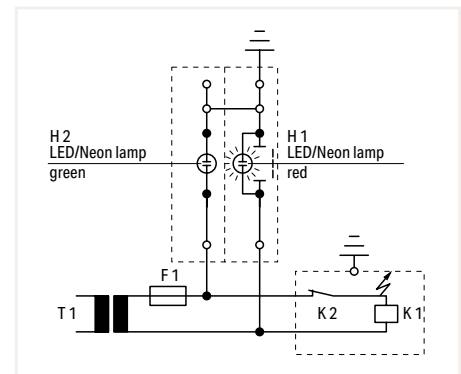

Test condition – grounding
 Slide link open, auxiliary circuit not grounded, red LED/
 neon lamp illuminates.



Testing via conductor entry.



Testing via jumper contact slot.

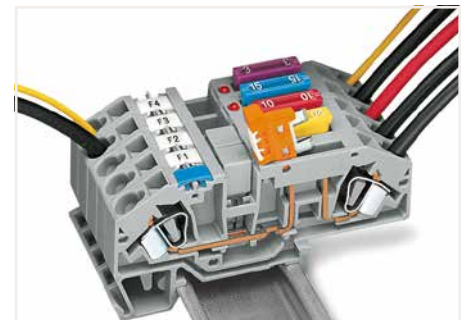

Power supply via disconnect link – disconnecting all out-puts.

IEC 60204/DIN VDE 0113 "Safety of machinery – Electrical equipment of machines – Part 1: General requirements," Section 9.4.3.1:

Ground faults on control circuits must not cause unintentional starting, hazardous movements, or prevent stopping of the machine.

In order to fulfill this requirement, a connection to the protective bonding circuit must be provided in accordance with Section 8.2 and the devices must be connected as described in Section 9.1.4. Control circuits fed from a transformer and not connected to the protective bonding circuit must be provided with an insulation monitoring device (e.g., residual current device), which either indicates a ground fault or interrupts the circuit automatically after a ground fault.

In the case of electronic circuits, the connection of one side of the control circuit to the protective bonding circuit in accordance with Section 9.1.4 can prevent unintentional operation. When this does not help, or if due to other reasons that electronic circuits cannot be connected to the protective bonding circuit, other measures must be taken to achieve the same level of safety.

Multipole control switches that interrupt all live conductors must be used where the control circuit is directly connected between the phase conductors of the supply or between a phase conductor and a neutral conductor, which is either not grounded or grounded through a high impedance. This is required for starting or stopping machine functions, which can cause a hazardous situation including: damaging the machine or halting work in progress in the event of unintentional starting or failure to stop.

Fuse Terminal Block for Automotive Blade-Style Fuses

6 mm²; 282 Series

Technical Data	
0.2 ... 6 mm ²	24 ... 10 AWG
400 V/6 kV/3 ① ②	12 V, 30 A ④
I _N 25 A (30 A) ③	12 V, 30 A ⑥
Terminal block width: 8 mm / 0.315 inch	
12 ... 13 mm / 0.47 ... 0.51 inch	

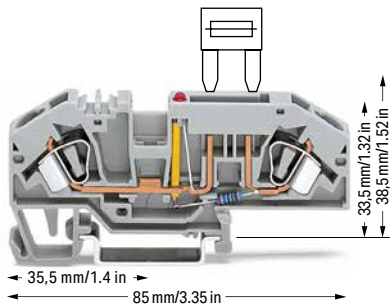

282-698/281-429

282-698/281-449

Technical Data	
0.2 ... 6 mm ²	24 ... 10 AWG
400 V/6 kV/3 ① ②	24 V, 30 A ④
I _N 25 A (30 A) ③	24 V, 30 A ⑥
Terminal block width: 8 mm / 0.315 inch	
12 ... 13 mm / 0.47 ... 0.51 inch	

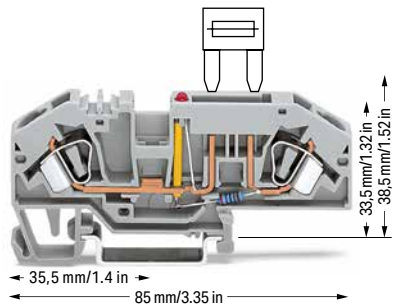

282-698/281-413

282-698/281-434

Technical Data	
0.2 ... 6 mm ²	24 ... 10 AWG
400 V/6 kV/3 ① ②	600 V, 30 A ④
I _N 25 A (30 A) ③	24 V, 30 A ⑥
Terminal block width: 8 mm / 0.315 inch	
12 ... 13 mm / 0.47 ... 0.51 inch	

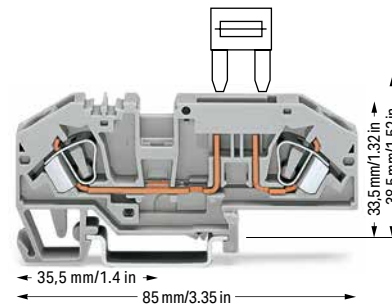

282-696

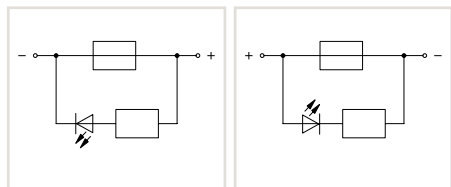

2-conductor fuse terminal block for automotive blade-style fuses; 12 V; with test point; with blown fuse indication by LED; LED power consumption: 4.8 mA
Electrical ratings are given by the fuse and blown fuse indication. Blade-style fuses: Observe touch-proof protection for 42 V and higher voltages!

Color	Item No.	Pack. Unit
○ gray	282-698/281-429	25
○ gray	282-698/281-449	25

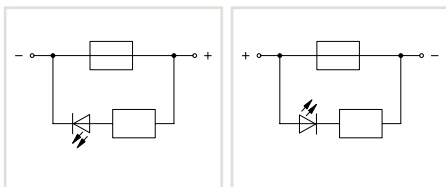

2-conductor fuse terminal block for automotive blade-style fuses; 24 V; with test point; with blown fuse indication by LED; LED power consumption: 4.8 mA
Electrical ratings are given by the fuse and blown fuse indication. Blade-style fuses: Observe touch-proof protection for 42 V and higher voltages!

Color	Item No.	Pack. Unit
○ gray	282-698/281-413	25
○ gray	282-698/281-434	25

2-conductor fuse terminal block for automotive blade-style fuses; with test point; without blown fuse indication; Electrical ratings are given by the fuse. Blade-style fuses: Observe touch-proof protection for 42 V and higher voltages!

Color	Item No.	Pack. Unit
○ gray	282-696	25

Other terminal blocks with the same profile:		
Through	282-699	Page 328

Accessories; 282 Series

Appropriate marking systems: WMB/Marking strips

End plate; 2 mm thick			
	gray	282-333	100 (25)
	orange	282-334	100 (25)

Adjacent jumper; insulated; I _N 41 A			
	gray	282-402	100 (25)
	yellow-green	282-422	100 (25)

Alternate jumper; insulated; I _N 41 A			
	gray	282-409	100 (25)

Test plug adapter; 8.3 mm wide; for 4 mm Ø test plug; for 1.5 ... 10 mm ² terminal blocks			
	gray	209-170	50 (25)

B-type test plug module; snaps together; 8 mm wide			
	gray	709-310	100 (25)

B-type spacer module; snaps together; 5 mm wide			
	gray	709-311	100 (25)

- ❶ 400 V = rated voltage
6 kV = rated impulse voltage
3 = pollution degree
 - ❷ Electrical ratings are given by the fuse (see page 344).
 - ❸ LED power consumption: 4.8 mA
- Blade-style fuses are not offered by WAGO.
Thermal automotive circuit breakers are not offered by WAGO.
WAGO recommends automotive circuit breakers from ETA.
- Please observe the application notes:
Marking, from page 640
- Approvals and corresponding ratings,
visit www.wago.com

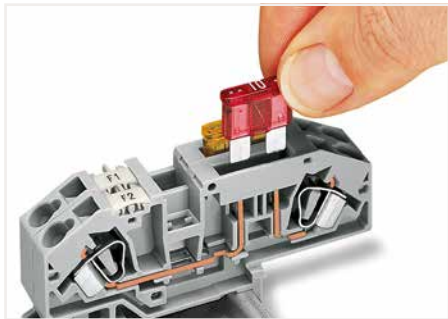

Inserting a fuse.



Blown fuse indication by LED

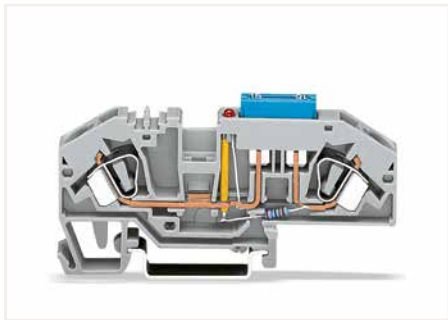

2-conductor fuse terminal block with mini-automotive blade-style fuse

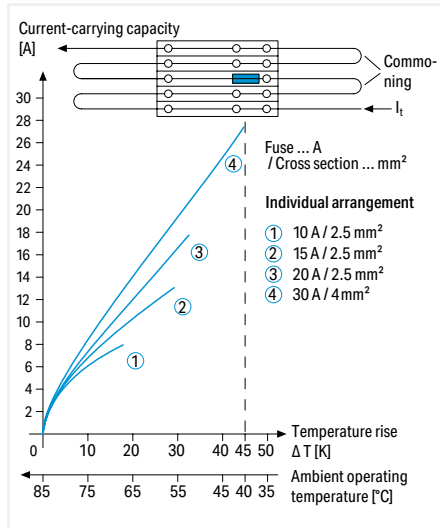

Application Notes on Fuse Terminal Blocks
Diagram: Individual arrangement

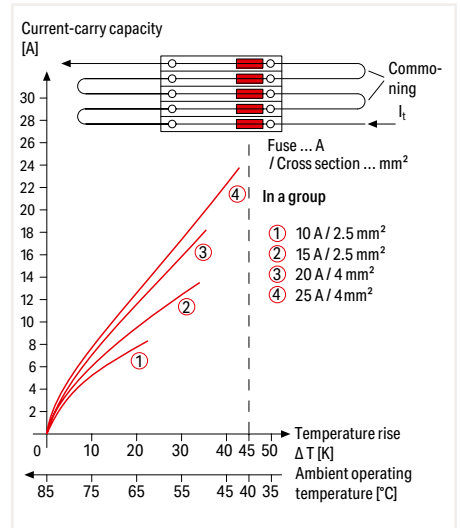

Application Notes on Fuse Terminal Blocks
Diagram: Block arrangement

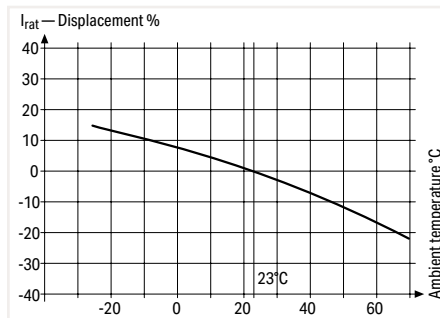

Application Notes on Fuse Terminal Blocks
Nominal current ratings for fuse cartridges are defined differently in international standards. This is why the recommended continuous current-carrying capacity of the fuses is a max. 80% of their nominal current according to DIN 72581/Part 3 (for a surrounding air temperature of 23°C).
Selecting the correct fuse cartridge is important for product safety within applications, as well as for fuse cartridge service life and reliability. Fuse cartridges will only operate perfectly as protection components (break-off point) if they are properly selected and used as intended (i.e., according to the state of the technology and valid specifications, as well as data sheet characteristics), according to basic safety requirements (i.e., persons, animals and property must be protected against hazards).

Information from the mini-automotive, blade-type fuse manufacturers

Derating T _{amb} / °C	%	F _T
-25	14	0.877
-20	13	0.885
-15	12	0.893
-10	11	0.901
- 5	10	0.909
0	9	0.917
5	8	0.926
10	6	0.943
15	4	0.962
20	2	0.980
23	0	1.000
30	- 2	1.020
35	- 4	1.042
40	- 6	1.064
45	- 8	1.087
50	-10	1.111
55	-13	1.149
60	-16	1.190
65	-19	1.235
70	-22	1.282

With regard to product safety, fuse cartridges must generally be tested both under normal and faulty operating conditions within your application.

Fused Disconnect Terminal Blocks with a Pivoting Fuse Holder; for Glass Cartridge Fuses

282 Series

Description and Installation



Blown fuse indication by LED or neon lamp



Fuse replacement:
Before replacing a fuse, pivot the fuse holder into the locked open position.

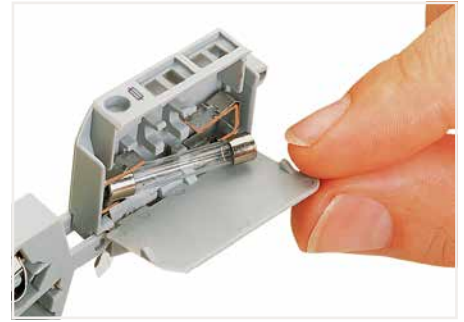

Fuse replacement:
One end of the fuse is automatically ejected from the holder when opening the cover.

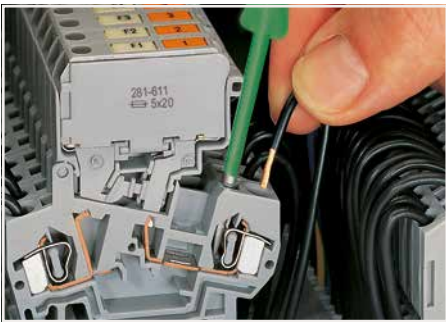

CAGE CLAMP® connection
Inserting a conductor.
With ferruled conductors, it is necessary to use a terminal block one size smaller than the conductor's nominal cross section.

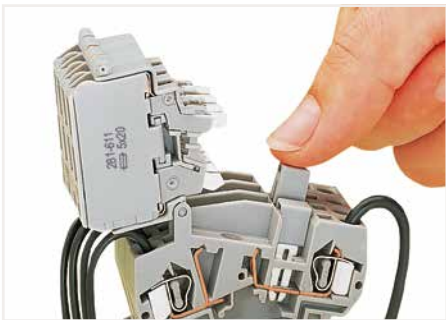

Commoning
Distributing current to several fuse-protected circuits via insulated push-in type jumpers.

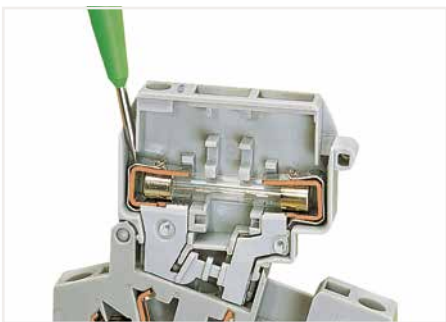
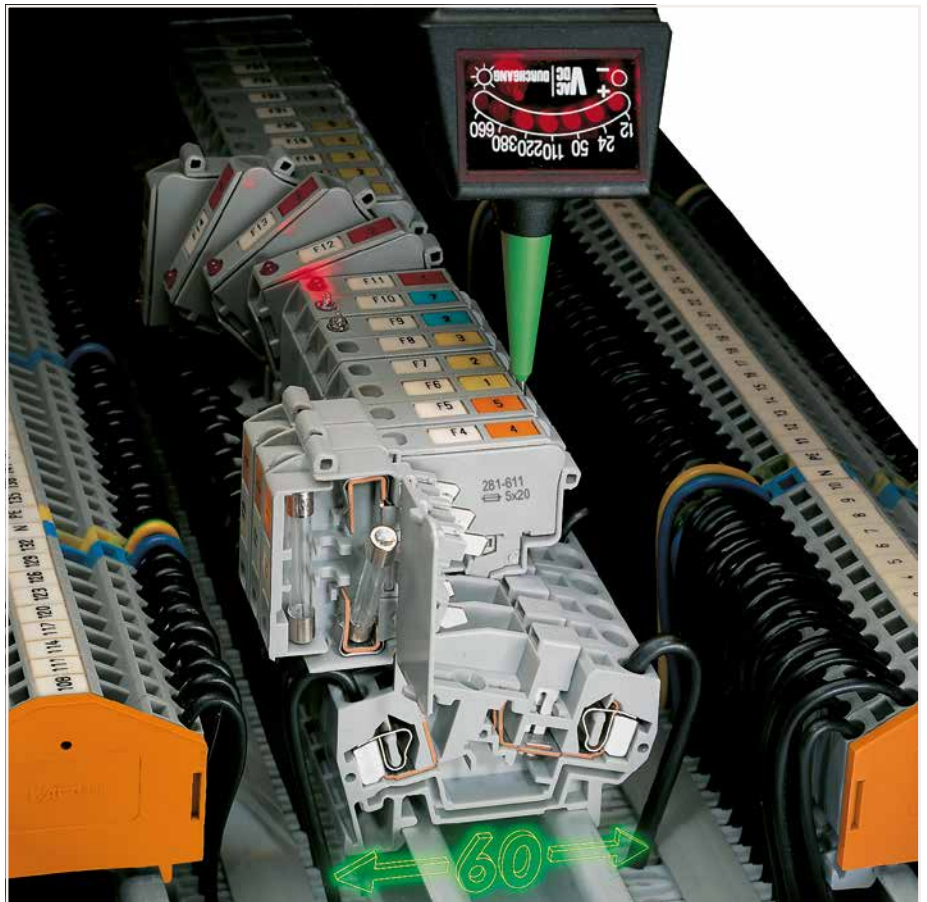

Voltage test, either at input or output with fuse holder in closed position (live)

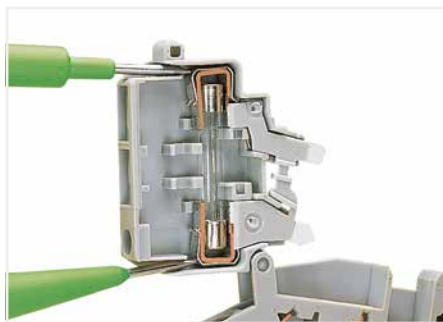

Through test with fuse holder in open position (no voltage)



Voltage test at input in the test slot of the current bar



CAGE CLAMP® terminates the following copper conductors: solid "s"



stranded "st"



fine-stranded "f-st", also with tinned single strands

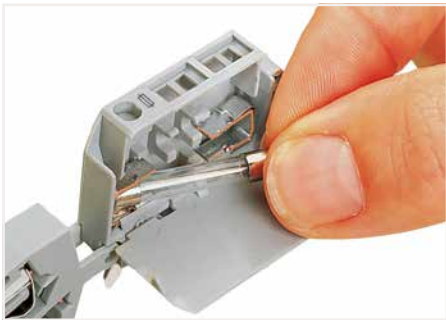

Fuse replacement:
Easily removing a fuse by hand.



Fuse replacement:
Insert a new fuse and snap the cover closed.



Storing a spare fuse (fuse holder without blown fuse indication).

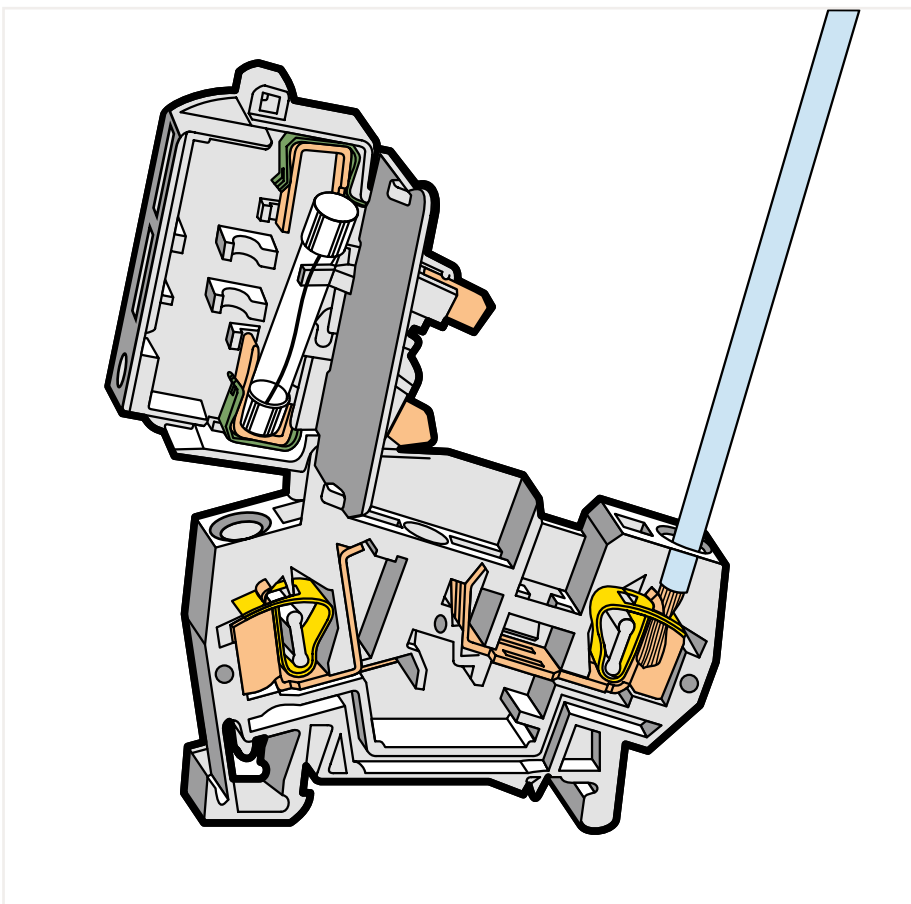

Touch-proof protection in all positions of the fuse holder

6



Fuse holder will remain safely locked open in vertical assemblies.



Testing voltage at the output via separate test slot.



Measuring current between jumper slot and separate test slot.



fine-stranded,
tip-bonded



fine-stranded,
with ferrule
(gastight crimped)



fine-stranded,
with pin terminal
(gastight crimped)

Fused Disconnect Terminal Block with a Pivoting Fuse Holder; for 5 x 20 mm, 5 x 25 mm and 5 x 30 mm Glass Cartridge Fuses 4 mm²; 281 Series

Technical Data	
0.08 ... 4 mm ²	28 ... 12 AWG
800 V/8 kV/3 ① ②	600 V, 10 A \overline{V}
I _N 10 A	600 V, 10 A [ⓐ]
Terminal block width: 8 mm / 0.315 inch	
9 ... 10 mm / 0.35 ... 0.39 inch	

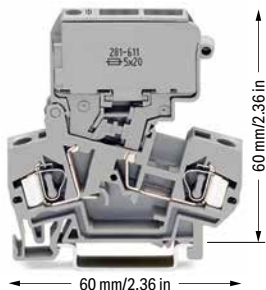

Dimensions (in mm):

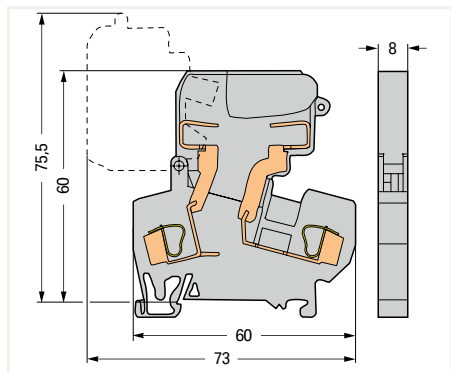

Fused disconnect terminal block with a pivoting fuse holder; for 5 x 20 mm glass cartridge fuse; without blown fuse indication
Electrical ratings are given by the fuse.

Color	Item No.	Pack. Unit
○ gray	281-611	50
● orange	281-616	50

Fused disconnect terminal block with a pivoting fuse holder; for 5 x 25 mm glass cartridge fuse; without blown fuse indication
Electrical ratings are given by the fuse.

○ gray	281-612	50
--------	---------	----

Fused disconnect terminal block with a pivoting fuse holder; for 5 x 30 mm glass cartridge fuse; without blown fuse indication
Electrical ratings are given by the fuse.

○ gray	281-622	50
--------	---------	----

Glass cartridge fuses are available upon request.

Technical Data	
0.08 ... 4 mm ²	28 ... 12 AWG
800 V/8 kV/3 ① ②	30 V, 10 A \overline{V}
I _N 10 A	230 V, 10 A [ⓐ]
Terminal block width: 8 mm / 0.315 inch	
9 ... 10 mm / 0.35 ... 0.39 inch	

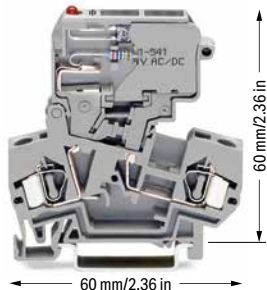

Dimensions (in mm):

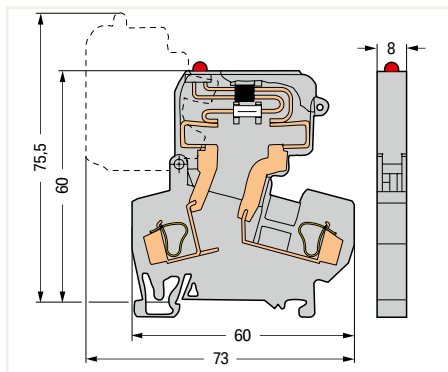

Fused disconnect terminal block with a pivoting fuse holder; for 5 x 20 mm glass cartridge fuse; with blown fuse indication by LED; gray
Electrical ratings are given by the fuse and blown fuse indication. Leakage current in case of a blown fuse: LED 6 mA

	Item No.	Pack. Unit
○ 15 ... 30 V	281-611/281-541	50
○ 30 ... 65 V	281-611/281-542	50

Fused disconnect terminal block with a pivoting fuse holder; for 5 x 25 mm glass cartridge fuse; with blown fuse indication by LED; gray
Electrical ratings are given by the fuse and blown fuse indication. Leakage current in case of a blown fuse: LED 6 mA

○ 15 ... 30 V	281-612/281-541	50
○ 30 ... 65 V	281-612/281-542	50

Fused disconnect terminal block with a pivoting fuse holder; for 5 x 30 mm glass cartridge fuse; with blown fuse indication by LED; gray
Electrical ratings are given by the fuse and blown fuse indication. Leakage current in case of a blown fuse: LED 6 mA

○ 15 ... 30 V	281-622/281-541	50
○ 30 ... 65 V	281-622/281-542	50

Glass cartridge fuses are available upon request.

Technical Data	
0.08 ... 4 mm ²	28 ... 12 AWG
800 V/8 kV/3 ① ②	220 V, 10 A \overline{V}
I _N 10 A	230 V, 10 A [ⓐ]
Terminal block width: 8 mm / 0.315 inch	
9 ... 10 mm / 0.35 ... 0.39 inch	

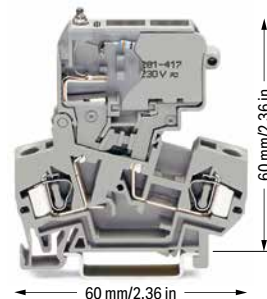

Dimensions (in mm):

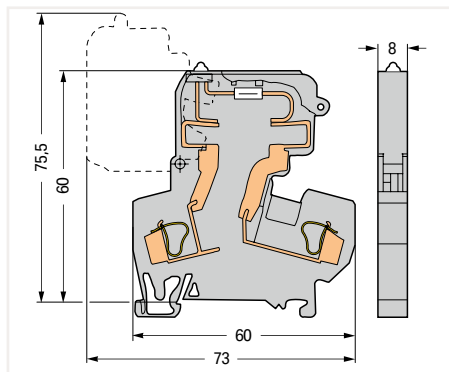

Fused disconnect terminal block with a pivoting fuse holder; for 5 x 20 mm glass cartridge fuse; with blown fuse indication by neon lamp; gray
Electrical ratings are given by the fuse and blown fuse indication. Leakage current in case of a blown fuse: Neon lamp < 0.4 mA

	Item No.	Pack. Unit
○ 230 V	281-611/281-417	50
○ 120 V	281-611/281-418	50

Fused disconnect terminal block with a pivoting fuse holder; for 5 x 25 mm glass cartridge fuse; with blown fuse indication by neon lamp; gray
Electrical ratings are given by the fuse and blown fuse indication. Leakage current in case of a blown fuse: Neon lamp < 0.4 mA

○ 230 V	281-612/281-417	50
○ 120 V	281-612/281-418	50

Fused disconnect terminal block with a pivoting fuse holder; for 5 x 30 mm glass cartridge fuse; with blown fuse indication by neon lamp; gray
Electrical ratings are given by the fuse and blown fuse indication. Leakage current in case of a blown fuse: Neon lamp < 0.4 mA

○ 230 V	281-622/281-417	50
○ 120 V	281-622/281-418	50

Glass cartridge fuses are available upon request.

Technical Data

0.08 ... 4 mm ²	28 ... 12 AWG
800 V/8 kW/3 ①	600 V, 16 A ②
<i>I_N</i> 16 A	
Terminal block width: 8 mm / 0.315 inch	
9 ... 10 mm / 0.35 ... 0.39 inch	



Dimensions (in mm):

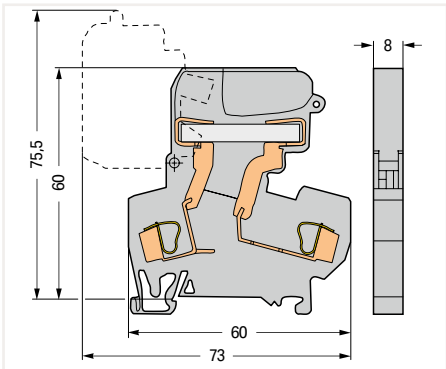

2-conductor disconnect terminal block

Color	Item No.	Pack. Unit
gray	281-624	100
orange	281-672	100

- ① 800 V = rated voltage
8 kV = rated impulse voltage
3 = pollution degree
(see Section 15)

- ② Electrical ratings are given by the fuse (see page 344).

Please observe the application notes:
Marking, from page 640

Approvals and corresponding ratings,
visit www.wago.com

Accessories; 281 Series

Appropriate marking systems:
WMB/WMB Inline/WFB

End and intermediate plate; 2.5 mm thick

gray	281-309	100 (25)
orange	281-311	100 (25)

Adjacent jumper; insulated; *I_N* = *I_N* terminal block

gray	281-402	200 (25)
------	---------	----------

Push-in type wire jumper; insulated; 0.75 mm² conductor cross section; *I_N* 9 A

L = 60 mm	249-125	100 (10)
L = 110 mm	249-126	100 (10)
L = 250 mm	249-127	100 (10)

Test plug adapter; 5 mm wide; for 4 mm Ø test plug; for 1.5 ... 4 mm² terminal blocks

gray	280-404	100 (25)
------	---------	----------

Test plug adapter; 6 mm wide; with CAGE CLAMP®; for 0.08 ... 2.5 mm²

<i>I_N</i> 24 A	281-407	100 (25)
---------------------------	---------	----------

Interlocking link; mechanically locks multiple links; 1 m long

transparent	210-254	1
-------------	---------	---



Fused disconnect or disconnect terminal blocks with a width of 8 mm can be assembled adjacently. At the end of an assembly or if there is no adjacent fused disconnect or disconnect terminal block, an end or intermediate plate must be used.



All fuse holders are printed with correct fuse size.

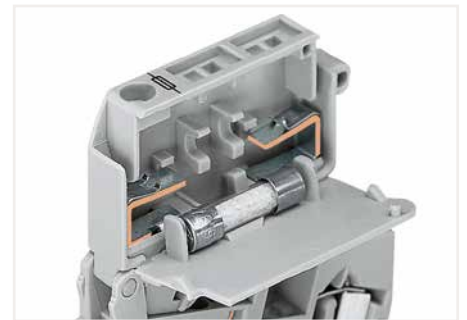

5 x 20 mm, 5 x 25 mm and ¼" x 1" fuse holders are fitted with stops on the inside of the cover.

Fused Disconnect Terminal Block with a Pivoting Fuse Holder; for 1/4" x 1" and 1/4" x 1 1/4" Glass Cartridge Fuses 4 mm²; 281 Series

Technical Data	
0.08 ... 4 mm ²	28 ... 12 AWG
800 V/8 kV/3 ① ②	600 V, 10 A ④
I _N 10 A	600 V, 10 A⑥
Terminal block width: 10 mm / 0.394 inch	
9 ... 10 mm / 0.35 ... 0.39 inch	



Dimensions (in mm):

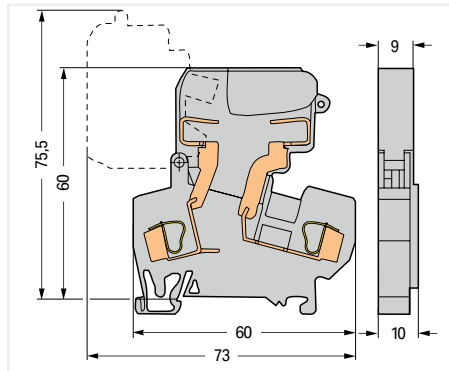

Fused disconnect terminal block with a pivoting fuse holder; for 1/4" x 1" glass cartridge fuse; without blown fuse indication
Electrical ratings are given by the fuse.

Color	Item No.	Pack. Unit
○ gray	281-613	50

Technical Data	
0.08 ... 4 mm ²	28 ... 12 AWG
800 V/8 kV/3 ① ②	30 V, 10 A ④
I _N 10 A	30 V, 10 A⑥
Terminal block width: 10 mm / 0.394 inch	
9 ... 10 mm / 0.35 ... 0.39 inch	



Dimensions (in mm):

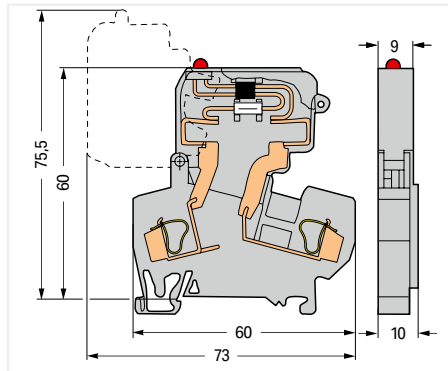

Fused disconnect terminal block with a pivoting fuse holder; for 1/4" x 1" glass cartridge fuse; with blown fuse indication by LED; gray
Electrical ratings are given by the fuse and blown fuse indication. Leakage current in case of a blown fuse: LED 6 mA

	Item No.	Pack. Unit
○ 15 ... 30 V	281-613/281-541	50
○ 30 ... 65 V	281-613/281-542	50

Technical Data	
0.08 ... 4 mm ²	28 ... 12 AWG
800 V/8 kV/3 ① ②	220 V, 10 A ④
I _N 10 A	100 V, 10 A⑥
Terminal block width: 10 mm / 0.394 inch	
9 ... 10 mm / 0.35 ... 0.39 inch	



Dimensions (in mm):

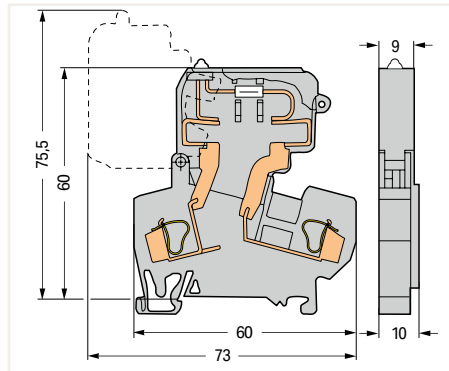

Fused disconnect terminal block with a pivoting fuse holder; for 1/4" x 1" glass cartridge fuse; with blown fuse indication by neon lamp; gray
Electrical ratings are given by the fuse and blown fuse indication. Leakage current in case of a blown fuse: Neon lamp < 0.4 mA

	Item No.	Pack. Unit
○ 230 V	281-613/281-417	50
○ 120 V	281-613/281-418	50

Fused disconnect terminal block with a pivoting fuse holder; for 1/4" x 1 1/4" glass cartridge fuse; without blown fuse indication Electrical ratings are given by the fuse.		
○ gray	281-623	50

Fused disconnect terminal block with a pivoting fuse holder; for 1/4" x 1 1/4" glass cartridge fuse; with blown fuse indication by LED; gray Electrical ratings are given by the fuse and blown fuse indication. Leakage current in case of a blown fuse: LED 6 mA		
○ 15 ... 30 V	281-623/281-541	50
○ 30 ... 65 V	281-623/281-542	50

Fused disconnect terminal block with a pivoting fuse holder; for 1/4" x 1 1/4" glass cartridge fuse; with blown fuse indication by neon lamp; gray Electrical ratings are given by the fuse and blown fuse indication. Leakage current in case of a blown fuse: Neon lamp < 0.4 mA		
○ 230 V	281-623/281-417	50
○ 120 V	281-623/281-418	50

Glass cartridge fuses are available upon request.

Glass cartridge fuses are available upon request.

Glass cartridge fuses are available upon request.

- ① 800 V = rated voltage
8 kV = rated impulse voltage
3 = pollution degree
(see Section 15)

- ② Electrical ratings are given by the fuse (see page 344).

Please observe the application notes:
Marking, from page 640

Approvals and corresponding ratings,
visit www.wago.com

Accessories; 281 Series

Appropriate marking systems:
WMB/WMB Inline/WFB

End and intermediate plate; 2.5 mm thick



gray	281-309	100 (25)
orange	281-311	100 (25)

Adjacent jumper; insulated; $I_N = I_N$ terminal block



gray	281-402	200 (25)
------	---------	----------

Push-in type wire jumper; insulated; 0.75 mm² conductor cross section; I_N 9 A



L = 60 mm	249-125	100 (10)
L = 110 mm	249-126	100 (10)
L = 250 mm	249-127	100 (10)

Test plug adapter; 5 mm wide; for 4 mm Ø test plug; for 1.5 ... 4 mm² terminal blocks



gray	280-404	100 (25)
------	---------	----------

Test plug adapter; 6 mm wide; with CAGE CLAMP®; for 0.08 ... 2.5 mm²



I_N 24 A	281-407	100 (25)
------------	---------	----------

Interlocking link; mechanically locks multiple links; 1 m long



transparent	210-254	1
-------------	---------	---



An intermediate plate is supplied with all 10 mm wide fused disconnect terminal blocks. At the end of an assembly or if there is no adjacent fused disconnect terminal block, an end or intermediate plate must be used.

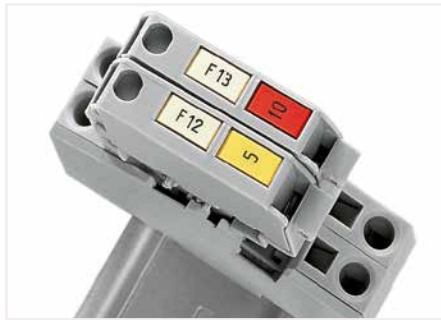

Each fuse holder features two marker slots for custom WMB Multi markers (example shows 8 mm wide terminal blocks).



Ganging several fuse holders with an interlocking link (example shows 8 mm wide terminal blocks).

Fuse Plug on Carrier Terminal Block 4 mm² 281 Series

Technical Data

250 V / I_N 6,3 A ④
Plug width: 6 mm / 0.236 inch



281-511

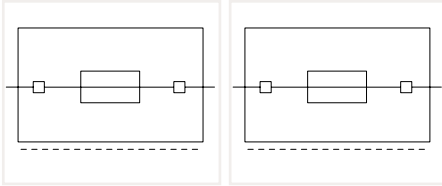

Fuse plug with pull-tab; for 5 x 20 mm and 5 x 25 mm glass cartridge fuses; 6 mm wide
Electrical ratings are given by the fuse.

Color	Item No.	Pack. Unit
○ gray	281-511	50

Fuse plug with pull-tab; for 5 x 20 mm and 5 x 25 mm glass cartridge fuses; with hole for one LED (for self-assembly); 6 mm wide; gray
Electrical ratings are given by the fuse and blown fuse indication.

○ gray	281-512	50
--------	---------	----

Technical Data

250 V / I_N 6,3 A ④
Plug width: 6 mm / 0.236 inch



281-512/281-501

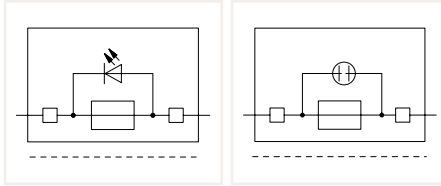

Fuse plug with pull-tab; for 5 x 20 mm and 5 x 25 mm glass cartridge fuses; with LED; 24 VAC/DC; 6 mm wide
Electrical ratings are given by the fuse and blown fuse indication. Leakage current in case of a blown fuse: LED 5 ... 20 mA

Color	Item No.	Pack. Unit
○ gray	281-512/281-501	50

Fuse plug with pull-tab; for 5 x 20 mm and 5 x 25 mm glass cartridge fuses; with neon lamp; 120 VAC/DC; 6 mm wide
Electrical ratings are given by the fuse and blown fuse indication. Leakage current in case of a blown fuse: Neon lamp < 0.4 mA

○ gray	281-512/281-418	50
--------	-----------------	----

Fuse plug with pull-tab; for 5 x 20 mm and 5 x 25 mm glass cartridge fuses; with neon lamp; 230 VAC/DC; 6 mm wide
Electrical ratings are given by the fuse and blown fuse indication. Leakage current in case of a blown fuse: Neon lamp < 0.4 mA

○ gray	281-512/281-417	50
--------	-----------------	----

Accessories; for fuse plugs

Appropriate marking systems: 4 mm wide WSB for plug and WMB terminal block

2-conductor carrier terminal block;
0.08 ... 4 mm² / 28 ... 12 AWG
Terminal block width: 6 mm / 0.236 inch

gray	281-916	50
------	---------	----

End and intermediate plate; 2.5 mm thick

orange	281-329	100 (25)
gray	281-328	100 (25)

3-conductor carrier terminal block;
0.08 ... 4 mm² / 28 ... 12 AWG
Terminal block width: 6 mm / 0.236 inch

gray	281-610	50
------	---------	----

End and intermediate plate; 2.5 mm thick

orange	281-326	100 (25)
gray	281-324	100 (25)

4-conductor carrier terminal block;
0.08 ... 4 mm² / 28 ... 12 AWG
Terminal block width: 6 mm / 0.236 inch

gray	281-656	50
------	---------	----

End and intermediate plate; 2.5 mm thick

orange	281-335	100 (25)
gray	281-334	100 (25)

Wire commoning chain; insulated; 50 connections; I_N 8 A

black	210-103	5
-------	---------	---

Wire commoning chain; insulated; 50 connections; I_N 8 A

blue	210-123	5
------	---------	---

④ Electrical ratings are given by the fuse or LED nominal voltage (see page 344).

Please observe the application notes:
Marking, from page 640

Approvals and corresponding ratings,
visit www.wago.com

Accessories; for fuse plugs

Appropriate marking systems:
WMB/WMB Inline

Comb-style jumper bar; insulated; I_N = I_N of terminal block

2-way	281-482	100 (25)
3-way	281-483	100 (25)
5-way	281-485	100 (25)
10-way	281-490	50 (25)

Alternate comb-style jumper bar; insulated; I_N = I_N of terminal block

2-way	281-492	100 (25)
-------	---------	----------

Operating tool; insulated

2-way	280-432	1
3-way	280-433	1
5-way	281-440	1

Shorting link; 5 x 20 mm; allows the fuse plug to be used as a disconnect plug

I _N 6.3 A	281-503	250 (25)
----------------------	---------	----------

WSB marking card; white, 10 strips with 10 markers/card; 4 mm wide WSB markers

plain	209-701	5
-------	---------	---

WSB marking card; plain; 10 strips with 10 markers/card; 4 mm wide WSB markers

yellow	209-701/000-002	5
red	209-701/000-005	5
blue	209-701/000-006	5
gray	209-701/000-007	5
orange	209-701/000-012	5
light green	209-701/000-017	5
green	209-701/000-023	5
violet	209-701/000-024	5

WSB marking card; for fuse plugs (281-5...); white; 4 mm wide WSB markers

F1, ..., F10 (10x)	209-787	5
F11, ..., F20 (10x)	209-700/209-124	5
F21, ..., F30 (10x)	209-700/209-125	5
F31, ..., F40 (10x)	209-700/209-126	5
F41, ..., F50 (10x)	209-700/209-127	5

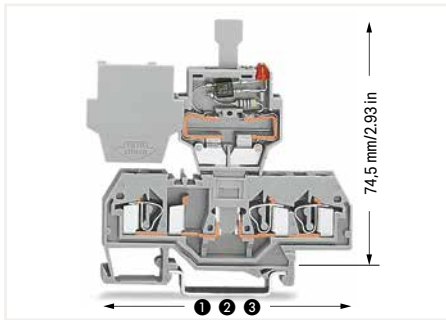

Length of carrier terminal blocks with a fuse plug:

- ① 59 mm / 2.32 inch for 281-916
- ② 73.5 mm / 2.89 inch for 281-610
- ③ 86 mm / 3.39 inch for 281-656

Terminal blocks with side marking, visit www.wago.com



Using fuse plugs with rail-mount terminal blocks for control circuit protection is highly advantageous because the function and wiring levels are separated:

- No additional cost for assembly and wiring
- No risk of accidental contact with live parts when disconnecting the fuse plug
- The fuse plug is completely separated from the carrier terminal block when replacing a fuse – away from current carrying parts
- The fuse plug can be removed by service personnel
- No unintentional reclosing of the circuit by another person
- Quickly exchange a fuse by using a prepared "stand-by plug"

Fuse plug features for quick and safe applications:

- Optional LED indicates blown fuse
- Top-of-unit marking slot provides clear carrier terminal block identification
- Two test slots with touch contacts
- Terminal blocks/plugs provide high-density wiring in a width of just 6 mm
- May be used as a disconnect plug in combination with a shorting link

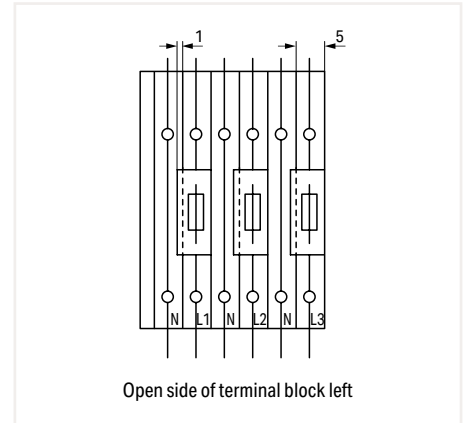

Open side of terminal block left

When a corresponding neutral circuit is adjacent to the fuse plug, a 5 mm wide space-saving terminal block may be used, as a 6 mm fuse plug may overlap the terminal block (see diagram).

For example, 5 mm (0.197 inch) wide carrier terminal blocks can be used with an end plate.

Fuse Plug on Carrier Terminal Block 2.5 mm² 280 Series

Technical Data

125 V / I_N 5 A ④

Plug width: 5 mm / 0.197 inch



280-850

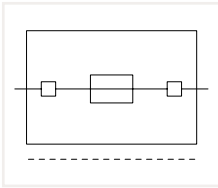

Fuse plug; with soldered miniature fuse; 5 mm wide; gray
Electrical ratings are given by the fuse.

	Item No.	Pack. Unit
○ 250 mA FF	280-850	100
○ 500 mA FF	280-852	100
○ 1 A FF	280-854	100
○ 2 A FF	280-856	100

Technical Data

125 V / I_N 5 A ④

Plug width: 5 mm / 0.197 inch



280-850/281-413

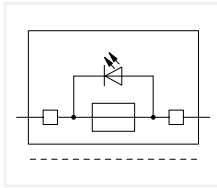

Fuse plug; with soldered miniature fuse; with additional indicator lamp; red LED; 15 ... 30 VDC; 5 mm wide; gray
Electrical ratings are given by the fuse and blown fuse indication. Leakage current in case of a blown fuse: LED 5 ... 20 mA

	Item No.	Pack. Unit
○ 250 mA FF	280-850/281-413	100
○ 500 mA FF	280-852/281-413	100
○ 1 A FF	280-854/281-413	100
○ 2 A FF	280-856/281-413	100

Accessories; for fuse plugs

Appropriate marking system: WMB

2-conductor carrier terminal block;
0.08 ... 2.5 mm² / 28 ... 12 AWG*
Terminal block width: 5 mm / 0.197 inch



gray 280-916 100

End and intermediate plate; 2.5 mm thick



orange 280-309 100 (25)
gray 280-308 100 (25)

3-conductor carrier terminal block;
0.08 ... 2.5 mm² / 28 ... 12 AWG*
Terminal block width: 5 mm / 0.197 inch



gray 280-610 100

End and intermediate plate; 2.5 mm thick



orange 280-326 100 (25)
gray 280-324 100 (25)

4-conductor carrier terminal block;
0.08 ... 2.5 mm² / 28 ... 12 AWG*
Terminal block width: 5 mm / 0.197 inch



gray 280-816 100

End and intermediate plate; 2.5 mm thick



orange 280-315 100 (25)
gray 280-314 100 (25)

Comb-style jumper bar; insulated; I_N = I_N of terminal block



2-way 280-482 200 (25)
3-way 280-483 200 (25)

Comb-style jumper bar; insulated; I_N = I_N of terminal block



10-way 280-490 50 (25)

Alternate comb-style jumper bar; insulated; I_N = I_N of terminal block



2-way 280-492 200 (25)

Operating tool; insulated



2-way 280-432 1
3-way 280-433 1

Operating tool; insulated



10-way 280-440 1

Wire commoning chain; insulated; 50 connections; I_N 8 A



black 210-103 5

Wire commoning chain; insulated; 50 connections; I_N 8 A



blue 210-123 5

*12 AWG: THHN, THWN

④ Electrical ratings are given by the fuse or LED nominal voltage (see page 344).

Please observe the application notes:
Marking, from page 640

Approvals and corresponding ratings,
visit www.wago.com

Accessories; for fuse plugs

Appropriate marking system:
WMB

WMB Inline, plain; 1,500 WMB markers (5 mm)/reel;
5 ... 5.2 mm stretchable



white 2009-115 1

WMB marking card; white; 10 strips with 10 markers/card;
5 ... 5.2 mm stretchable



plain 793-5501 5

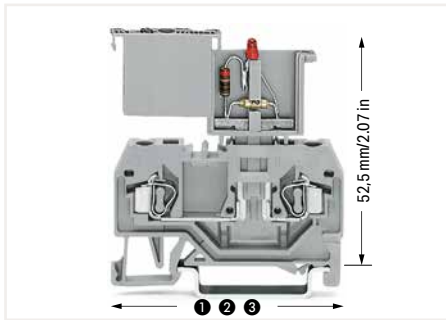

Length of carrier terminal blocks with a fuse plug:

- ① 53 mm / 2.09 inch for 280-916
- ② 64 mm / 2.52 inch for 280-610
- ③ 75 mm / 2.95 inch for 280-816

Terminal blocks with side marking, visit www.wago.com

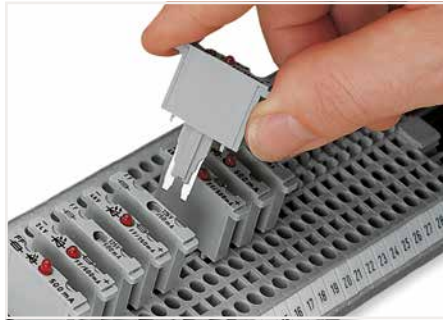

Using fuse plugs with rail-mount terminal blocks (280/281 and 769 Series) for control circuit protection is highly advantageous because the function and wiring levels are separated:

- No additional cost for assembly and wiring
- No risk of accidental contact with live parts when disconnecting the fuse plug
- Quick plug replacement in case of a blown fuse
- The fuse plug can be removed by service personnel
- No unintentional reclosing of the circuit by another person
- Terminal blocks/plugs provide ultra high-density wiring in a width of just 5 mm
- Optional LED indicates blown fuse

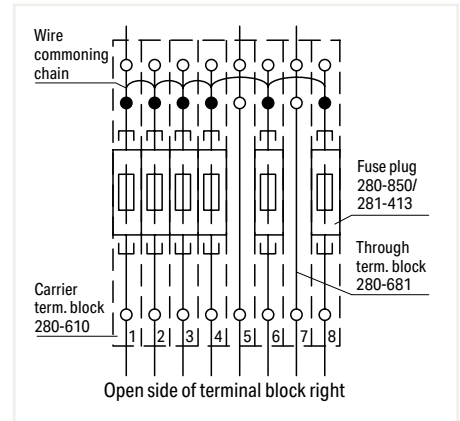

Fuse protection of individual outputs – supply via wire commoning chain

Fuse Terminal Block for 10 x 38 mm (1 3/32" x 1 1/2") Cylindrical Fuses and Class CC Fuses 16 mm²; 811 Series

Technical Data	
2.5 ... 16 mm ²	14 ... 6 AWG
1000 VDC, 32 A	1000 VDC, 30 A [Ⓢ]

Terminal block width: 17.5 mm / 0.689 inch
 12 ... 13 mm / 0.47 ... 0.51 inch

Technical Data	
2.5 ... 16 mm ²	14 ... 6 AWG
690 VAC, 32 A	750 VAC, 30 A [Ⓢ]
1000 VDC, 32 A	600 VAC, 30 A [Ⓢ]
	1000 VDC, 30 A [Ⓢ] Ⓢ

Terminal block width: 17.5 mm / 0.689 inch
 12 ... 13 mm / 0.47 ... 0.51 inch

Technical Data	
2.5 ... 16 mm ²	14 ... 6 AWG
32 A	600 V, 30 A [Ⓢ]
	600 V, 30 A [Ⓢ]

Terminal block width: 17.5 mm / 0.689 inch
 12 ... 13 mm / 0.47 ... 0.51 inch



Dimensions (in mm):

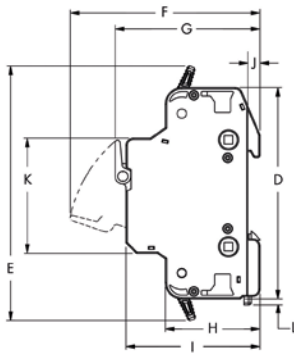

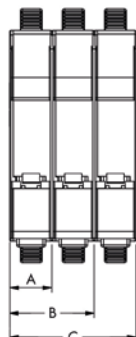

Dimension	mm (inch)
A	17.3 (0.68)
B	34.6 (1.36)
C	51.9 (2.04)
D	87 (3.43)
E	104.9 (4.13)
F	78.3 (3.08)
G	59.7 (2.35)
H	39 (1.54)
I	55.2 (2.17)
J	5 (0.2)
K	47.4 (1.87)
L	2.5 (0.1)

Fuse terminal block for 10 x 38 mm (1 3/32" x 1 1/2") cylindrical fuses; for photovoltaic applications; without blown fuse indication; for DIN-35 rail per EN 60715; light gray

Pole No.	Item No.	Pack. Unit
○ 1-pole	811-316	12

Fuse terminal block for 10 x 38 mm (1 3/32" x 1 1/2") cylindrical fuses; without blown fuse indication; for DIN-35 rail per EN 60715; light gray

Pole No.	Item No.	Pack. Unit
○ 1-pole	811-310	12
○ 2-pole	811-320	6
○ 3-pole	811-330	4

Fuse terminal block for class CC fuses; without blown fuse indication; for DIN-35 rail per EN 60715; light gray

Pole No.	Item No.	Pack. Unit
○ 1-pole	811-410	12
○ 2-pole	811-420	6
○ 3-pole	811-430	4

Fuse terminal block for 10 x 38 mm (1 3/32" x 1 1/2") cylindrical fuses; for photovoltaic applications; with blown fuse indication; 230 ... 1000 VDC; for DIN-35 rail; light gray

○ 1-pole	811-317	12
----------	---------	----

Fuse terminal block for 10 x 38 mm (1 3/32" x 1 1/2") cylindrical fuses; with blown fuse indication; 90 ... 600 VAC; 115 ... 600 VDC; for DIN-35 rail; light gray

○ 1-pole	811-311	12
○ 2-pole	811-321	6
○ 3-pole	811-331	4

Fuse terminal block for class CC fuses; with blown fuse indication; 90 ... 600 VAC; 115 ... 600 VDC; for DIN-35 rail; light gray

○ 1-pole	811-411	12
○ 2-pole	811-421	6
○ 3-pole	811-431	4

Fuse terminal block for 10 x 38 mm (1 3/32" x 1 1/2") cylindrical fuses; with blown fuse indication; 24 VDC; for DIN-35 rail; light gray

○ 1-pole	811-314	12
----------	---------	----

Fuse terminal block for class CC fuses; with blown fuse indication; 24 VDC; for DIN-35 rail; light gray

○ 1-pole	811-414	12
----------	---------	----

Accessories; 811 Series

Appropriate marking systems: WMB/Marking strips

Supply module; 35 mm ² ; 600 VAC; 1000 VDC	Item No.	Pack. Unit
	811-471	16(4)

Coupling kit; for 12 poles	Item No.	Pack. Unit
	811-612	1

WMB Inline, plain; 1,500 WMB markers (5 mm)/reel; 5 ... 5.2 mm stretchable	Item No.	Pack. Unit
	2009-115	1

Test plug; with 500 mm cable; 2 mm Ø; max. 42 V	Item No.	Pack. Unit
 red	210-136	50

Marker carrier; for POWER CAGE CLAMP 35/50/95 mm ² ; 10.4 mm wide	Item No.	Pack. Unit
 gray	285-442	25

WMB marking card; white; 10 strips with 10 markers/card; stretchable 5 ... 5.2 mm	Item No.	Pack. Unit
 plain	793-5501	5

Cylindrical fuses are not offered by WAGO. Temperature range: -35 ... +85 °C
Electrical ratings are given by the fuse and blown fuse indication.

Please observe the application notes:
Marking, from page 640

Approvals and corresponding ratings,
visit www.wago.com

Accessories; 811 Series

Appropriate marking systems:
WMB/Marking strips

Push-in type jumper bar; insulated; I_n 63 A



2-way	811-472	50 (10)
3-way	811-473	40 (10)
4-way	811-474	40 (10)
5-way	811-475	40 (10)
6-way	811-476	30 (10)
7-way	811-477	20 (10)
8-way	811-478	20 (10)
9-way	811-479	20 (10)
10-way	811-480	20 (10)
11-way	811-481	20 (10)
12-way	811-482	20 (10)

Twin ferrule only for 811 Series; insulated; 12 mm long



Sleeve for 2 x 2.5 mm ² / 14 AWG	216-545	100
Sleeve for 2 x 4 mm ² / 12 AWG	216-546	100
Sleeve for 2 x 6 mm ² / 10 AWG	216-547	100

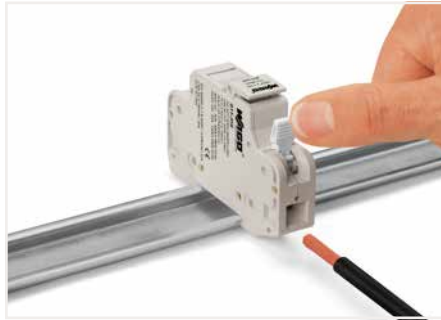

CAGE CLAMP® connection
Inserting a conductor.
Opening the clamping unit via integrated lever.



Terminating ferruled conductors up to 10 mm² (8 AWG).



Inserting a fuse.



Removing a terminal block from the DIN-rail.



Open and close lever via operating tool.



Marker carriers (285-442) for continuous marking strips



WMB marking location for convenient identification



Jumper bar for quick and convenient commoning



Creating a 2- or 3-pole fuse terminal block via coupling kit.

Application Notes on Terminal Blocks for Glass Cartridge Fuses

Terminal Blocks for Glass Cartridge Fuses Tested per IEC or EN 60947-7-3/VDE 0611-6

When selecting glass cartridge fuses, make sure that the maximum power loss listed below is not exceeded.

The power loss is determined according to IEC or EN 60947-7-3/VDE 0611-6 at 23°C.

The temperature rise of the terminal blocks must be checked according to their application and mounting.

Higher ambient temperatures represent an additional impact on fuse cartridges. Therefore, in such applications, the rated current must be reduced if necessary.

More details are available from the manufacturers.

Glass Cartridge Fuses (5 x 20 mm)

Series Item No.	Overload and Short-Circuit Protection		Short-Circuit Protection Only	
	Individual Arrangement	Block Arrangement	Individual Arrangement	Block Arrangement
Fuse terminal blocks (with screw cap), front-entry (5 x 20 mm)				
282-122 282-124	2.5 W	2.5 W	4 W	4 W
Fused disconnect terminal block with a pivoting fuse holder for glass cartridge fuses (5 x 20 mm)				
281-611 281-616 281-611/281-541 281-611/281-542 281-611/281-417 281-611/281-418	2.5 W	1.6 W	4 W	4 W
Fuse plugs for glass cartridge fuses (5 x 20 mm)				
281-511 281-512 281-512/281-501 281-512/281-418 281-512/281-417	2.5 W	1.6 W	4 W	4 W

Glass Cartridge Fuses (6.3 x 32 mm)

Series Item No.	Overload and Short-Circuit Protection		Short-Circuit Protection Only	
	Individual Arrangement	Block Arrangement	Individual Arrangement	Block Arrangement
Fuse terminal blocks (with screw cap), front-entry (1/4" x 11/4" ≈ 6.3 x 32 mm)				
282-128 282-128/281-418 282-128/281-413 282-128/281-417	2.5 W	2.5 W	4 W	4 W
Fused disconnect terminal block with a pivoting fuse holder for glass cartridge fuses (1/4" x 11/4" ≈ 6.3 x 32 mm)				
281-623 281-623/281-541 281-623/281-542 281-623/281-417 281-623/281-418	2.5 W	1.6 W	4 W	2.5 W

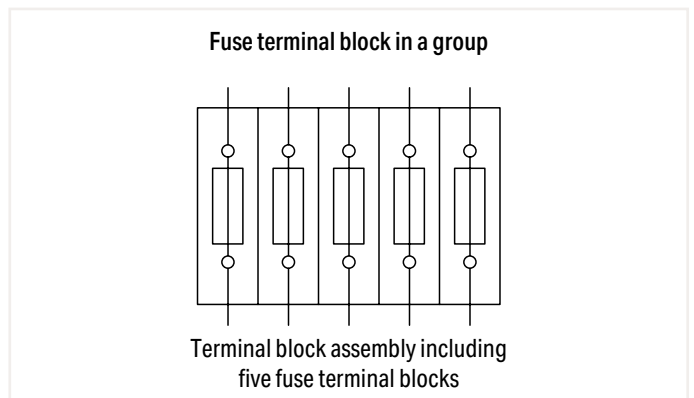
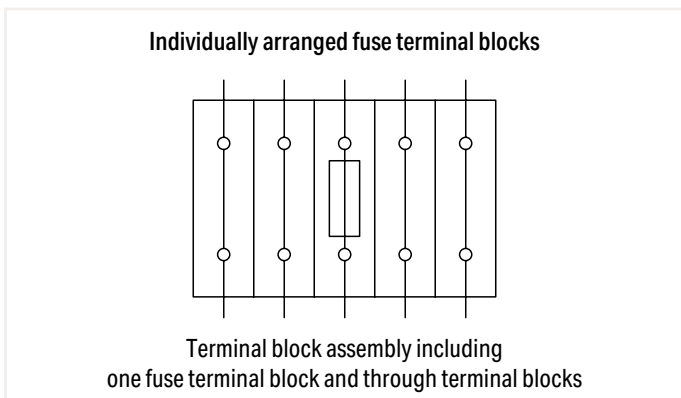

Sensor Terminal Blocks and Actuator Terminal Blocks

280 Series

Description and Installation

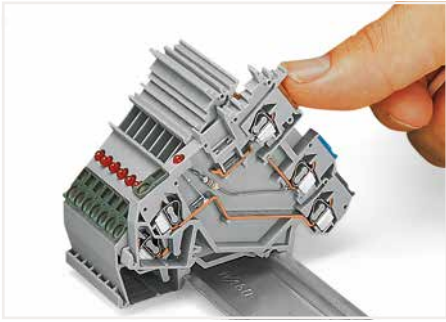

Snapping a terminal block onto the DIN-rail. Terminal blocks with a grounding foot automatically establish a direct contact to the rail.

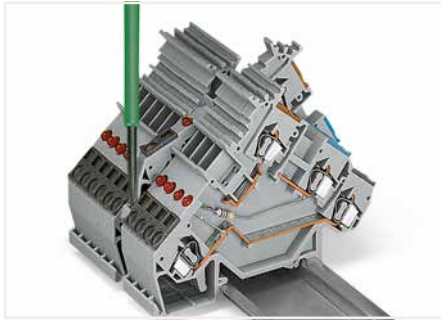

Removing a terminal block from the DIN-rail. Notice: Remove jumper contacts first.

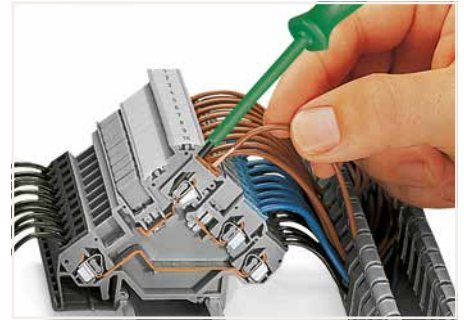

CAGE CLAMP® connection
Inserting a conductor via straight operating tool (210-720).

6

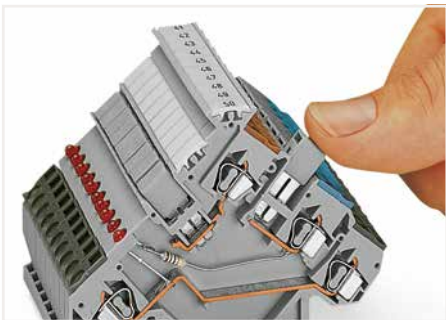

Commoning using an adjacent jumper (280-402). Push jumper down until fully inserted.

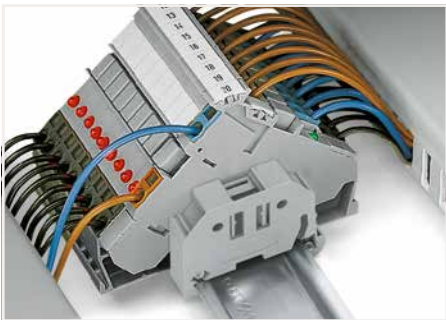
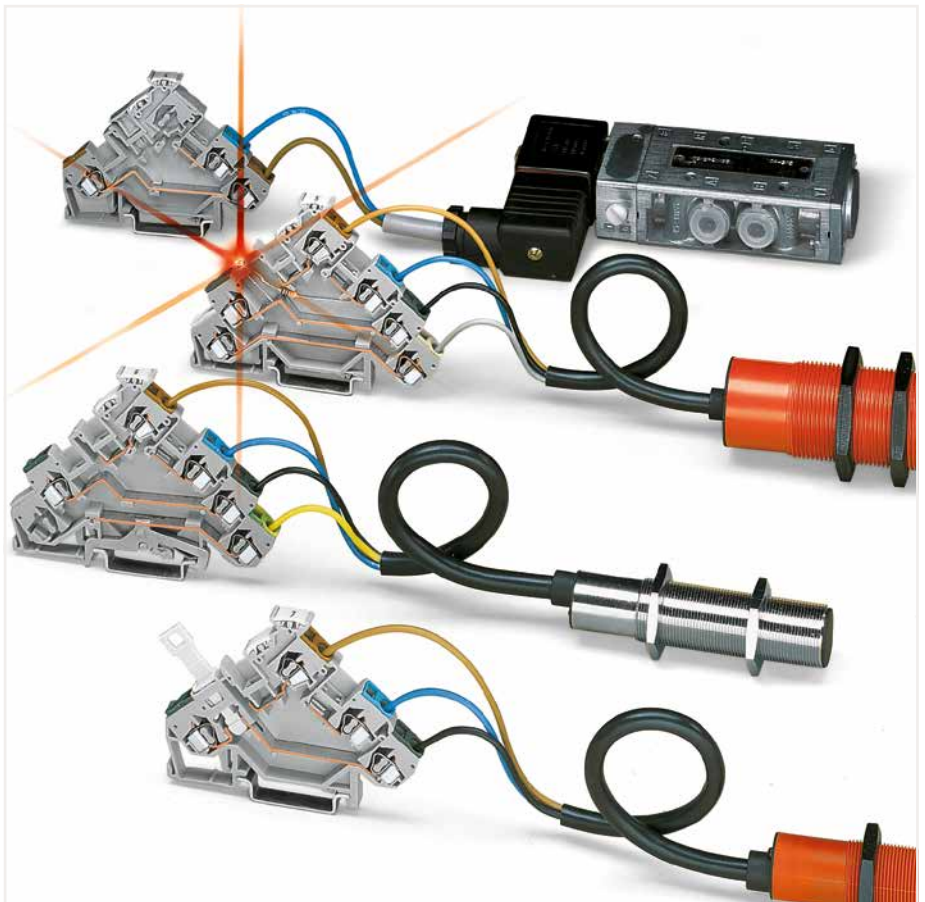

Sensor terminal blocks
Power supply from control panel side



Sensor terminal blocks
Power supply from sensor side

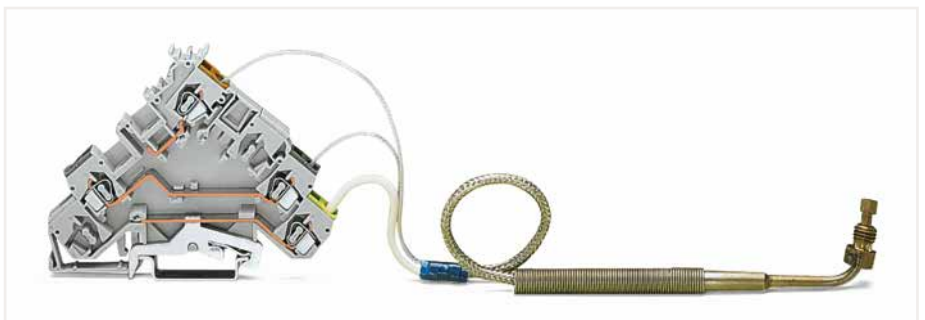

Actuator terminal block; with shield connection; with a thermocouple



CAGE CLAMP® terminates the following copper conductors: solid "s"



stranded "st"



fine-stranded "f-st", also with tinned single strands

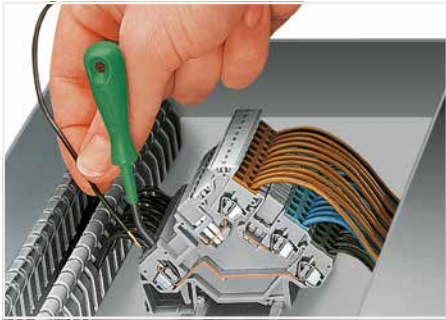

CAGE CLAMP® connection
Inserting a conductor via angled operating tool (210-658).

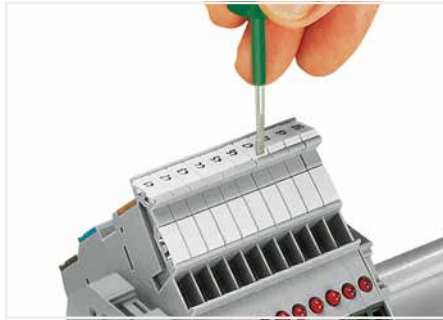

Labeling via WMB Multi Marking System.

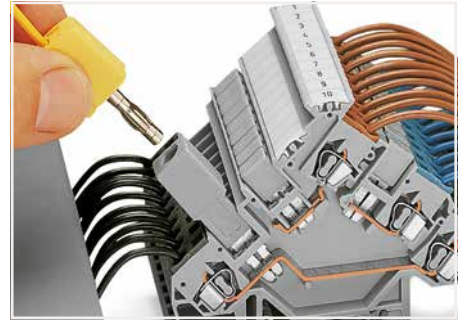

Testing via banana plug and test plug adapter (209-170).

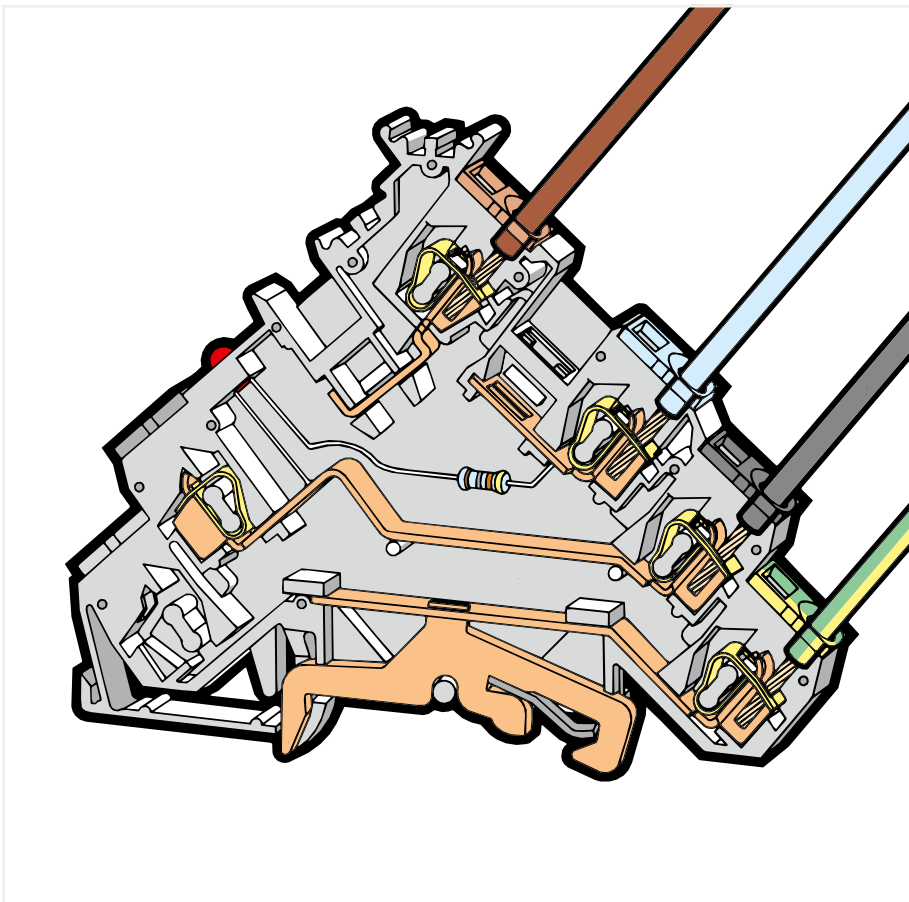

Testing via voltage tester directly on the current bar.

6



Actuator terminal blocks with fuse holders (281-511) – intermediate plates are required!

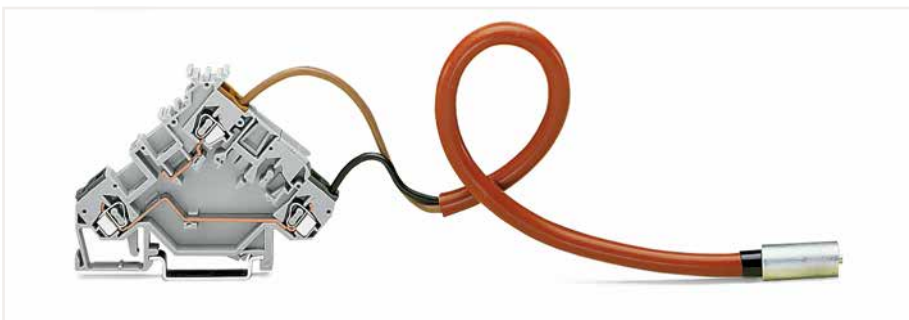

Actuator terminal block with thermocouple

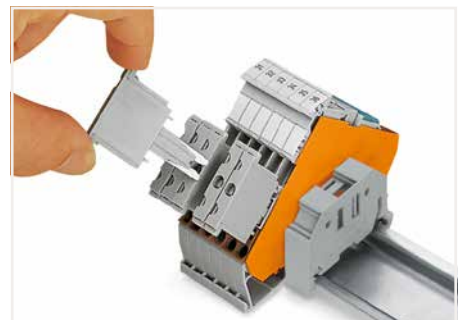

Actuator terminal blocks with component plugs (280 801)



fine-stranded,
tip-bonded



fine-stranded,
with ferrule
(gastight crimped)



fine-stranded,
with pin terminal
(gastight crimped)

Sensor terminal block; for 3-conductor sensors 2.5 mm²; 280 Series

Technical Data	
0.08 ... 2.5 mm ²	28 ... 12 AWG*
400 V/6 kV/3 ①	300 V, 15 A ②
I _N 20 A	300 V, 15 A ③
Terminal block width: 5 mm / 0.197 inch	
8 ... 9 mm / 0.31 ... 0.35 inch	

Technical Data	
0.08 ... 2.5 mm ²	28 ... 12 AWG*
250 V/4 kV/3 ①	300 V, 6 A ②
I _N 6 A	300 V, 15 A ③
Terminal block width: 5 mm / 0.197 inch	
8 ... 9 mm / 0.31 ... 0.35 inch	

Technical Data	
0.08 ... 2.5 mm ²	28 ... 12 AWG*
400 V/6 kV/3 ①	300 V, 10 A ②
I _N 10 A	300 V, 15 A ③
Terminal block width: 5 mm / 0.197 inch	
8 ... 9 mm / 0.31 ... 0.35 inch	

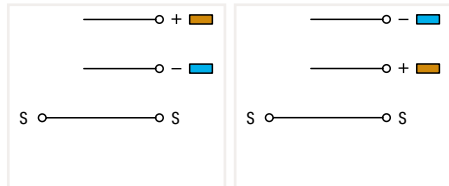
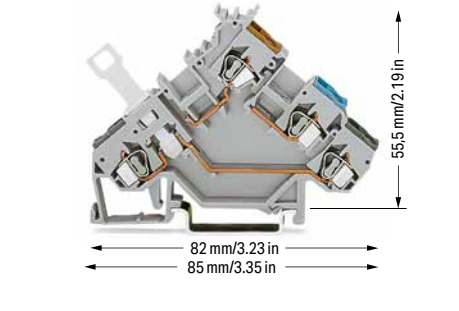
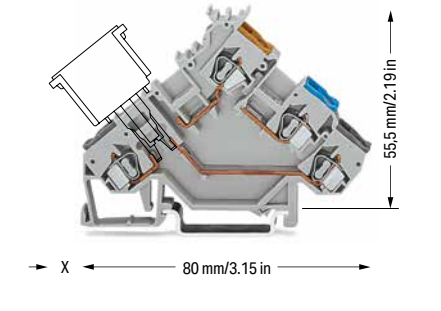
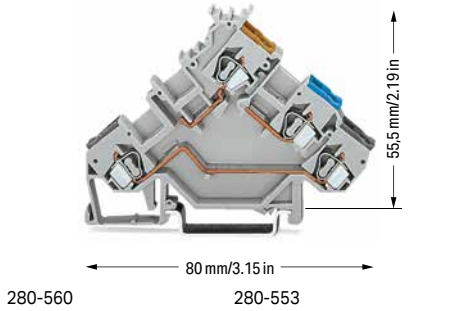

Sensor terminal block		
Color	Item No.	Pack. Unit
○ gray	280-560	50
○ gray	280-553	50

Sensor terminal block; for component plugs		
Color	Item No.	Pack. Unit
○ gray	280-561 ③	50

Sensor disconnect terminal block; for signal interruption		
Color	Item No.	Pack. Unit
○ gray	280-563	50

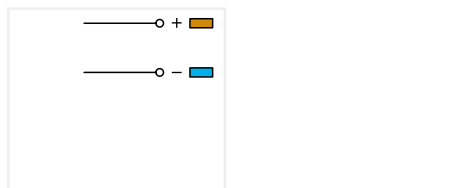
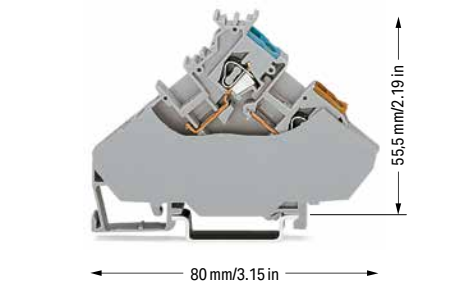
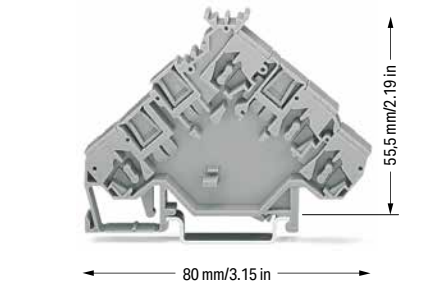
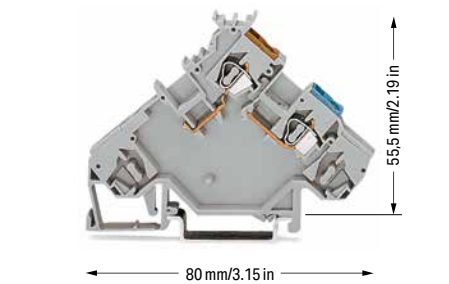

Sensor supply terminal block; power supply from sensor side		
Color	Item No.	Pack. Unit
○ gray	280-564	10

Spacer; same profile as 3-conductor sensor terminal blocks or corresponding actuator terminal blocks Spacers with the same profile clearly differentiate between sensor or actuator terminal groups, e.g., of different power supply.		
Color	Item No.	Pack. Unit
○ gray	280-559	50

Sensor supply terminal block; power supply from control panel side; with end plate Terminal block width: 6 mm / 0.236 inch		
Color	Item No.	Pack. Unit
○ gray	280-567	20

Technical Data	
400 V/6 kV/3	I _N 20 A

6

- *12 AWG: THHN, THWN
 - ❶ 400 V / 250 V = rated voltage
6 kV / 4 kV = rated impulse voltage
3 = pollution degree
(see Section 15)
 - ❷ Electrical ratings are given by the fuse plug or empty component plug housing.
 - ❸ Empty component plug housings, see Full Line Catalog, Interface Modules, Volume 4
x = 12 mm/0.472 inch
Fuse plug (280-850), see page 340
x = 20 mm/0.787 inch
- Please observe the application notes:
Insulation stop, see page 346
Marking, from page 640
- Approvals and corresponding ratings,
visit www.wago.com



Sensor terminal block paired with a 3-conductor sensor

Accessories; 280 Series
Appropriate marking system:
WMB

End and intermediate plate; 1 mm thick; for triple-deck terminal blocks

	orange	280-321	100 (25)
	gray	280-319	100 (25)

Insulation stop; 0.08 ... 0.2 mm² "s" (0.14 mm² "f-st"); 5 pcs/strip

	white	280-470	200 (25)
---	-------	---------	----------

Insulation stop; 0.25 ... 0.5 mm²; 5 pcs/strip

	light gray	280-471	200 (25)
---	------------	---------	----------

Insulation stop; 0.75 ... 1 mm²; 5 pcs/strip

	dark gray	280-472	200 (25)
---	-----------	---------	----------

Adjacent jumper; insulated; I_N = I_N terminal block

	gray	280-402	200 (25)
---	------	---------	----------

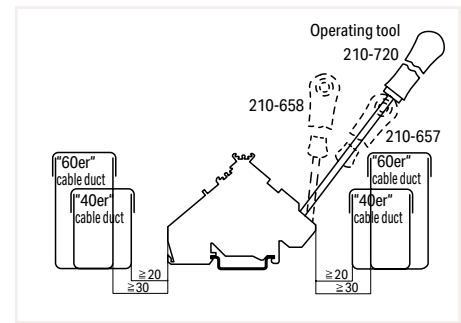

Min. mounting distance – terminal blocks to cable duct

6

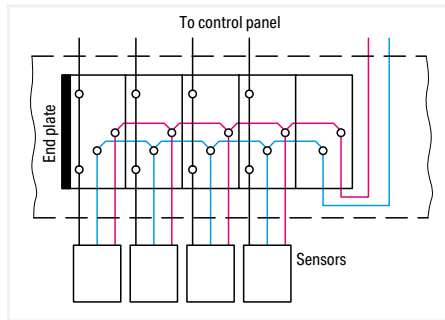

Power supply from sensor side

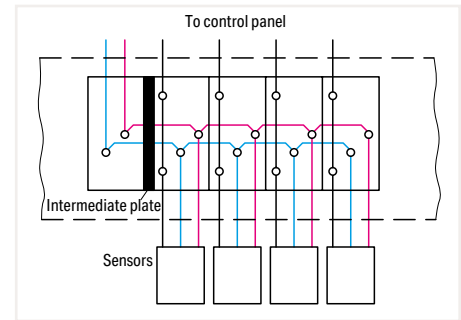

Power supply from control panel side

Sensor LED Terminal Block; for 3-Conductor Sensors

2.5 mm²; 280 Series

Technical Data

0.08 ... 2.5 mm ²	28 ... 12 AWG*
24 VDC ⓘ	24 V, 15 A ⓘ
20 A	300 V, 15 A ⓘ
Terminal block width: 5 mm / 0.197 inch	
8 ... 9 mm / 0.31 ... 0.35 inch	

Technical Data

0.08 ... 2.5 mm ²	28 ... 12 AWG*
24 VDC ⓘ	24 V, 15 A ⓘ
20 A	300 V, 15 A ⓘ
Terminal block width: 5 mm / 0.197 inch	
8 ... 9 mm / 0.31 ... 0.35 inch	

*12 AWG: THHN, THWN

ⓘ Other voltages are available upon request.

Please observe the application notes:
Insulation stop, see page 346
Marking, from page 640

Approvals and corresponding ratings,
visit www.wago.com

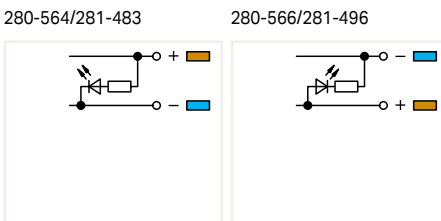
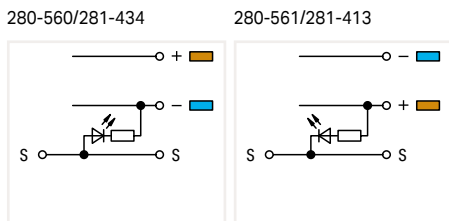
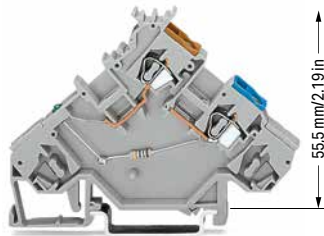
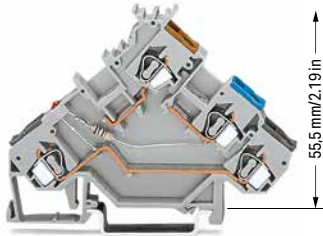

Sensor LED terminal block; for PNP (high-side) switching sensors; red LED; LED power consumption: 4.8 mA

Color	Item No.	Pack. Unit
○ gray	280-560/281-434	50

Sensor LED supply terminal block; power supply from sensor side; for PNP (high-side) switching sensors; green LED; LED power consumption: 4.8 mA

Color	Item No.	Pack. Unit
○ gray	280-564/281-483	10

Sensor LED terminal block; for NPN (low-side) switching sensors; red LED; LED power consumption: 4.8 mA

○ gray	280-561/281-413	50
--------	-----------------	----

Sensor LED supply terminal block; power supply from sensor side; for NPN (low-side) switching sensors; green LED; LED power consumption: 4.8 mA

○ gray	280-566/281-496	10
--------	-----------------	----

Accessories; 280 Series

Appropriate marking system: WMB

End and intermediate plate; 1 mm thick; for triple-deck terminal blocks

	orange	280-321	100 (25)
	gray	280-319	100 (25)

Insulation stop; 0.08 ... 0.2 mm² "s" (0.14 mm² "f-st"); 5 pcs/strip

	white	280-470	200 (25)
--	-------	---------	----------

Insulation stop; 0.25 ... 0.5 mm²; 5 pcs/strip

	light gray	280-471	200 (25)
--	------------	---------	----------

Insulation stop; 0.75 ... 1 mm²; 5 pcs/strip

	dark gray	280-472	200 (25)
--	-----------	---------	----------

Adjacent jumper; insulated; I_N = I_N terminal block

	gray	280-402	200 (25)
--	------	---------	----------

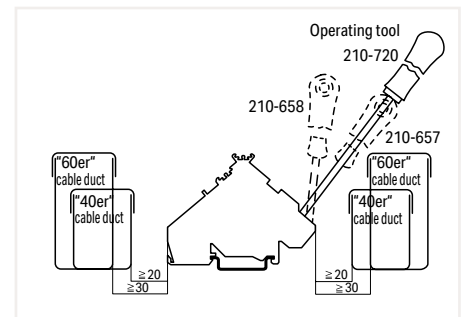
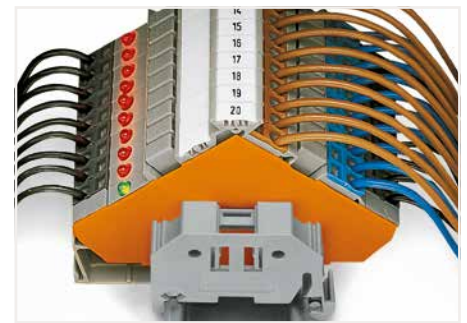

Min. mounting distance – terminal blocks to cable duct

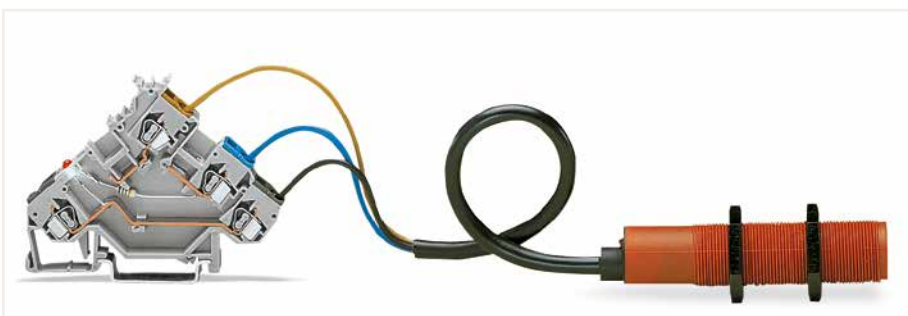

Sensor LED terminal block with a 3-conductor sensor

Sensor LED Terminal Block; for 4-Conductor Sensors 2.5 mm²; 280 Series

Technical Data	
0.08 ... 2.5 mm ²	28 ... 12 AWG*
24 VDC ⓘ	24 V, 15 A
20 A	300 V, 15 A
Terminal block width: 5 mm / 0.197 inch	
8 ... 9 mm / 0.31 ... 0.35 inch	

Technical Data	
0.08 ... 2.5 mm ²	28 ... 12 AWG*
24 VDC ⓘ	24 V, 15 A
20 A	300 V, 15 A
Terminal block width: 5 mm / 0.197 inch	
8 ... 9 mm / 0.31 ... 0.35 inch	

*12 AWG: THHN, THWN

ⓘ Other voltages are available upon request.

Please observe the application notes:
Insulation stop, see page 346
Marking, from page 640

Approvals and corresponding ratings,
visit www.wago.com

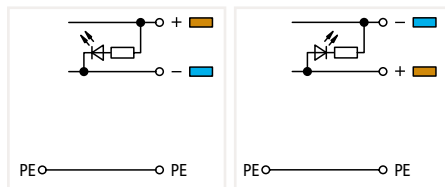
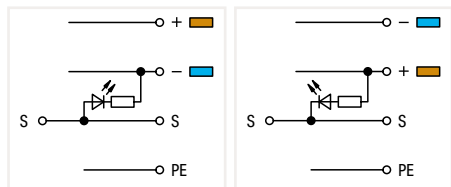

Sensor LED terminal block; for PNP (high-side) switching sensors; red LED; LED power consumption: 4.8 mA

Sensor LED supply terminal block; power supply from sensor side; for PNP (high-side) switching sensors; green LED; LED power consumption: 4.8 mA

Color	Item No.	Pack. Unit
○ gray	280-570/281-434	50

Color	Item No.	Pack. Unit
○ gray	280-574/281-483	10

Sensor LED terminal block; for NPN (low-side) switching sensors; red LED; LED power consumption: 4.8 mA

Sensor LED supply terminal block; power supply from sensor side; for NPN (low-side) switching sensors; green LED; LED power consumption: 4.8 mA

○ gray	280-571/281-413	50
--------	-----------------	----

○ gray	280-576/281-496	10
--------	-----------------	----

Sensor LED supply terminal block; power supply from control panel side; for PNP (high-side) switching sensors; green LED; LED power consumption: 4.8 mA
Terminal block width: 6 mm / 0.236 inch

○ gray	280-577/281-496	20
--------	-----------------	----



6

Accessories; 280 Series

Appropriate marking system: WMB

End and intermediate plate; 1 mm thick; for quadruple-deck terminal blocks

orange	280-323	100 (25)
gray	280-320	100 (25)

Insulation stop; 0.25 ... 0.5 mm²; 5 pcs/strip

light gray	280-471	200 (25)
------------	---------	----------

Insulation stop; 0.08 ... 0.2 mm² "s" (0.14 mm² "f-st"); 5 pcs/strip

white	280-470	200 (25)
-------	---------	----------

Insulation stop; 0.75 ... 1 mm²; 5 pcs/strip

dark gray	280-472	200 (25)
-----------	---------	----------

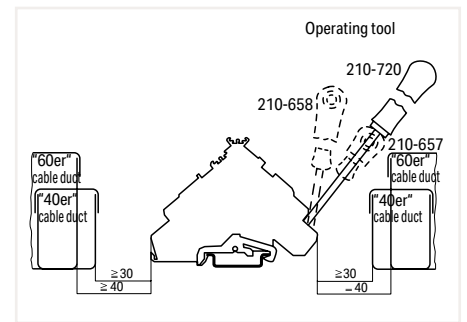

Min. mounting distance – terminal blocks to cable duct

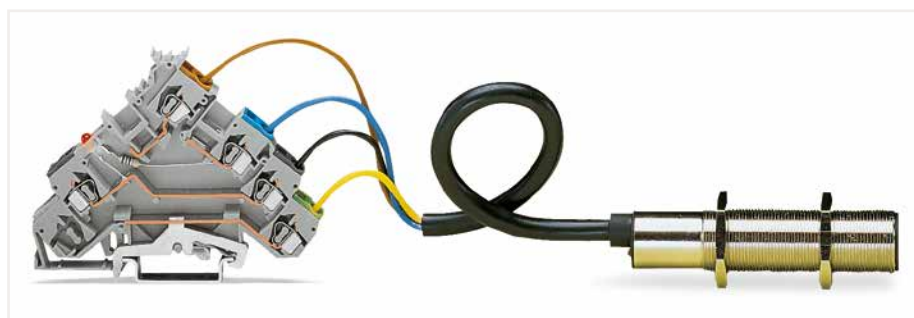

Sensor LED terminal block paired with a 3-conductor sensor (ground connection)

Sensor terminal block; with ground connection; for 3-conductor sensors 2.5 mm²; 280 Series

Technical Data	
0.08 ... 2.5 mm ²	28 ... 12 AWG*
400 V/6 kV/3 ①	300 V, 15 A ②
I _N 20 A	300 V, 15 A ③
Terminal block width: 5 mm / 0.197 inch	
8 ... 9 mm / 0.31 ... 0.35 inch	

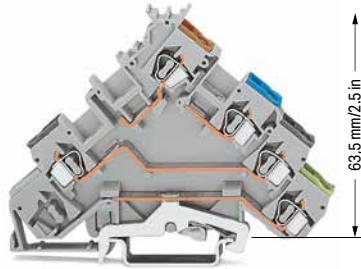

90,5 mm/3.56 in

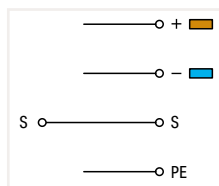

Sensor terminal block; with ground connection		
Color	Item No.	Pack. Unit
○ gray	280-570	50

Technical Data	
0.08 ... 2.5 mm ²	28 ... 12 AWG*
250 V/4 kV/3 ①	300 V, 6 A ②
I _N 6 A	300 V, 15 A ③
Terminal block width: 5 mm / 0.197 inch	
8 ... 9 mm / 0.31 ... 0.35 inch	

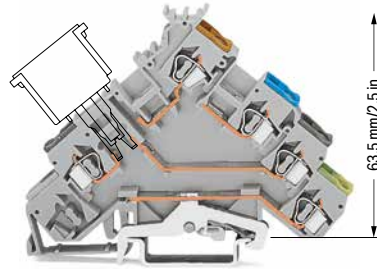

90,5 mm/3.56 in

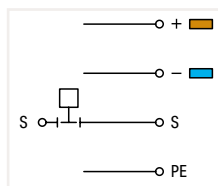

Sensor terminal block; with ground connection; for component plugs		
Color	Item No.	Pack. Unit
○ gray	280-571 ③	50

Technical Data	
0.08 ... 2.5 mm ²	28 ... 12 AWG*
400 V/6 kV/3 ①	300 V, 10 A ②
I _N 10 A	300 V, 15 A ③
Terminal block width: 5 mm / 0.197 inch	
8 ... 9 mm / 0.31 ... 0.35 inch	

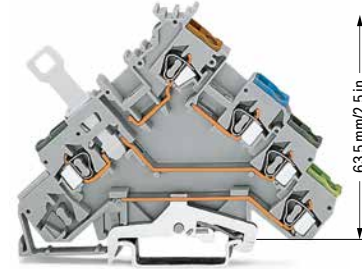

90,5 mm/3.56 in

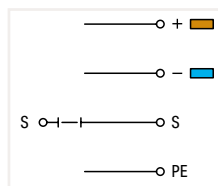

Sensor disconnect terminal block; with ground connection; for signal interruption		
Color	Item No.	Pack. Unit
○ gray	280-573	50

6

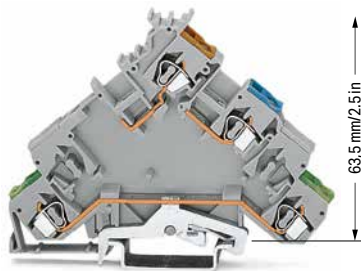

90,5 mm/3.56 in

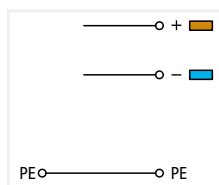

Sensor supply terminal block; with ground connection; power supply from sensor side		
Color	Item No.	Pack. Unit
○ gray	280-574	10



90,5 mm/3.56 in

Spacer; same profile as 4-conductor sensor terminal blocks; 3-conductor sensor terminal blocks with ground connection or corresponding actuator terminal blocks Spacers with the same profile clearly differentiate between sensor or actuator terminal groups, e.g., of different power supply.		
Color	Item No.	Pack. Unit
○ gray	280-582	50

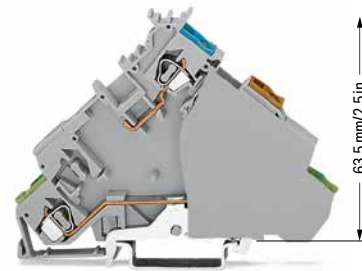

90,5 mm/3.56 in

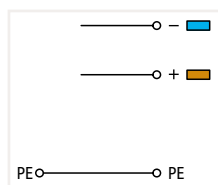

Sensor supply terminal block; with ground connection; power supply from control panel side; with end plate Terminal block width: 6 mm / 0.236 inch		
Color	Item No.	Pack. Unit
○ gray	280-577	20

Technical Data	
400 V/6 kV/3	I _N 20 A

*12 AWG: THHN, THWN

1 400 V / 250 V = rated voltage
6 kV / 4 kV = rated impulse voltage
3 = pollution degree
(see Section 15)

2 Electrical ratings are given by the fuse plug or empty component plug housing.

3 Empty component plug housings, see Full Line Catalog, Interface Modules, Volume 4
x = 12 mm/0.472 inch
Fuse plug (280-850), see page 340
x = 20 mm/0.787 inch

Please observe the application notes:
Insulation stop, see page 346
Marking, from page 640

Approvals and corresponding ratings, visit www.wago.com

Accessories; 280 Series

Appropriate marking system:
WMB

End and intermediate plate; 1 mm thick; for quadruple-deck terminal blocks

	orange	280-323	100 (25)
	gray	280-320	100 (25)

Insulation stop; 0.08 ... 0.2 mm² "s" (0.14 mm² "f-st"); 5 pcs/strip

	white	280-470	200 (25)
---	-------	---------	----------

Insulation stop; 0.25 ... 0.5 mm²; 5 pcs/strip

	light gray	280-471	200 (25)
---	------------	---------	----------

Insulation stop; 0.75 ... 1 mm²; 5 pcs/strip

	dark gray	280-472	200 (25)
---	-----------	---------	----------

Adjacent jumper; insulated; I_N = I_N terminal block

	gray	280-402	200 (25)
---	------	---------	----------



Sensor terminal block paired with a 3-conductor sensor

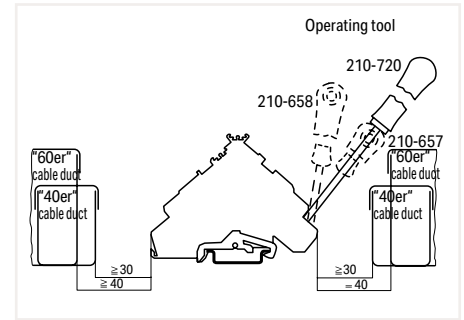

Min. mounting distance – terminal blocks to cable duct

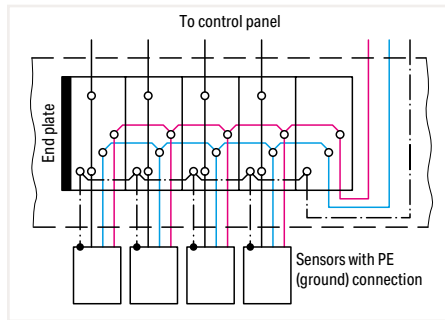

Power supply from sensor side

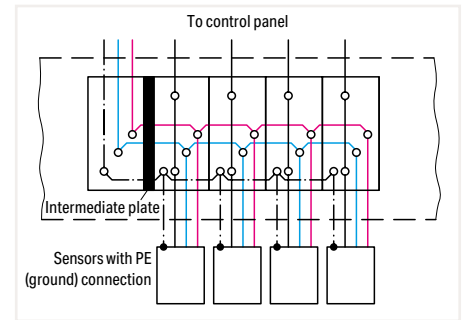

Power supply from control panel side

Sensor terminal block; for 4-conductor sensors 2.5 mm²; 280 Series

Technical Data	
0.08 ... 2.5 mm ²	28 ... 12 AWG*
400 V/6 kV/3 ①	300 V, 15 A ②
I _N 20 A	300 V, 15 A ③
Terminal block width: 5 mm / 0.197 inch	
8 ... 9 mm / 0.31 ... 0.35 inch	

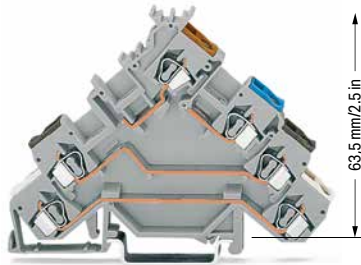

90,5 mm/3.56 in

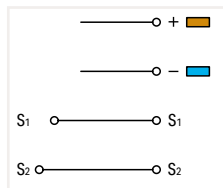

Sensor terminal block		
Color	Item No.	Pack. Unit
○ gray	280-580	50

Technical Data	
0.08 ... 2.5 mm ²	28 ... 12 AWG*
125 V / 5 A ②	300 V, 6 A ③
250 V / 6.3 A ②	300 V, 15 A ③
Terminal block width: 5 mm / 0.197 inch	
8 ... 9 mm / 0.31 ... 0.35 inch	

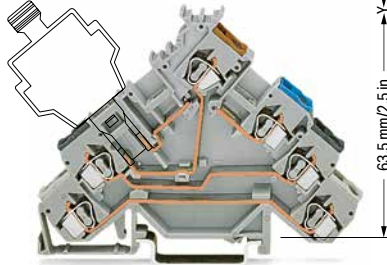

90,5 mm/3.56 in

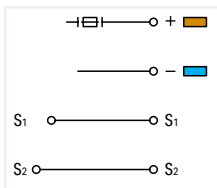

Sensor LED terminal block; for fuse plugs; for PNP (high-side) switching sensors; without end plate		
Color	Item No.	Pack. Unit
○ gray	280-588 ④	50

Technical Data	
0.08 ... 2.5 mm ²	28 ... 12 AWG*
400 V/6 kV/3 ①	24 V, 15 A ②
I _N 10 A	300 V, 15 A ③
Terminal block width: 6 mm / 0.236 inch	
8 ... 9 mm / 0.31 ... 0.35 inch	

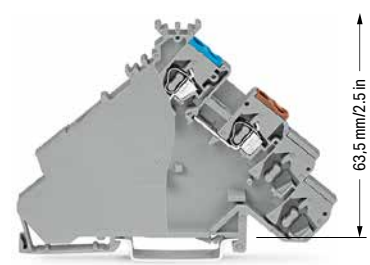

90,5 mm/3.56 in



Sensor supply terminal block; power supply from control panel side; with end plate		
Color	Item No.	Pack. Unit
○ gray	280-587	50

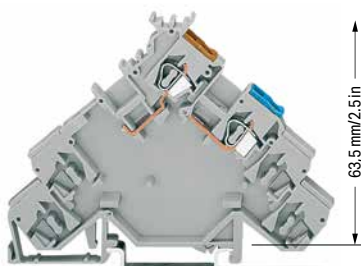

90,5 mm/3.56 in



Sensor supply terminal block; power supply from sensor side; without end plate		
Color	Item No.	Pack. Unit
○ gray	280-584	10

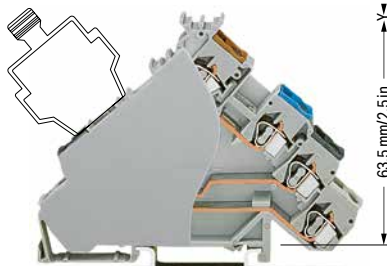

90,5 mm/3.56 in

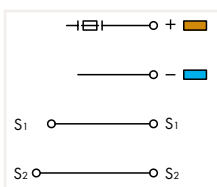

Sensor LED terminal block; for fuse plugs; for PNP (high-side) switching sensors; with gray end plate		
Color	Item No.	Pack. Unit
○ gray	280-588/280-320	50



Sensor LED terminal block; for fuse plugs; for PNP (high-side) switching sensors; with orange end plate		
Color	Item No.	Pack. Unit
○ gray	280-588/280-323	50

6

- *12 AWG: THHN, THWN
 - ❶ 400 V = rated voltage
6 kV = rated impulse voltage
3 = pollution degree
(see Section 15)
 - ❷ Electrical ratings are given by the fuse plug or empty component plug housing.
 - ❸ Empty component plug housings, see Full Line Catalog, Interface Modules, Volume 4
x = 12 mm/0.472 inch
Fuse plug (281-511), see page 338
y = 15.5 mm/0.61 inch
x = 10 mm/0.394 inch
- Please observe the application notes:
Insulation stop, see page 346
Marking, from page 640
- Approvals and corresponding ratings,
visit www.wago.com

Accessories; 280 Series
Appropriate marking system:
WMB

End and intermediate plate; 1 mm thick; for quadruple-deck terminal blocks

	orange	280-323	100 (25)
	gray	280-320	100 (25)

Insulation stop; 0.08 ... 0.2 mm² "s" (0.14 mm² "f-st"); 5 pcs/strip

	white	280-470	200 (25)
---	-------	---------	----------

Insulation stop; 0.25 ... 0.5 mm²; 5 pcs/strip

	light gray	280-471	200 (25)
---	------------	---------	----------

Insulation stop; 0.75 ... 1 mm²; 5 pcs/strip

	dark gray	280-472	200 (25)
---	-----------	---------	----------

Adjacent jumper; insulated; I_N = I_N terminal block

	gray	280-402	200 (25)
---	------	---------	----------



Sensor terminal block paired with a 4-conductor sensor

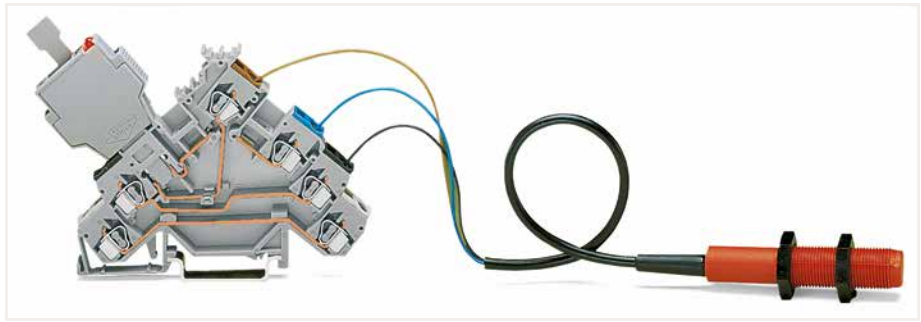

Sensor terminal block (with a fuse plug) paired with a 3-conductor sensor

6



The fuse plug is 1 mm wider than the terminal block, so an intermediate plate must be installed.

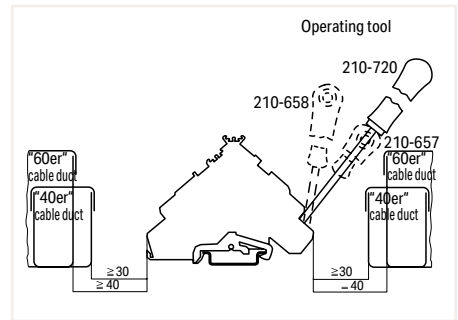

Min. mounting distance – terminal blocks to cable duct

Sensor LED Terminal Block; for 4-Conductor Sensors 2.5 mm²; 280 Series

Technical Data	
0.08 ... 2.5 mm ²	28 ... 12 AWG*
24 VDC ①	24 V, 15 A ②
20 A	
Terminal block width: 5 mm / 0.197 inch	
8 ... 9 mm / 0.31 ... 0.35 inch	

Technical Data	
0.08 ... 2.5 mm ²	28 ... 12 AWG*
24 VDC ①	24 V, 15 A ②
20 A	300 V, 15 A ③
Terminal block width: 5 mm / 0.197 inch	
8 ... 9 mm / 0.31 ... 0.35 inch	

*12 AWG: THHN, THWN

① Other voltages are available upon request.

Please observe the application notes:
Insulation stop, see page 346
Marking, from page 640

Approvals and corresponding ratings,
visit www.wago.com

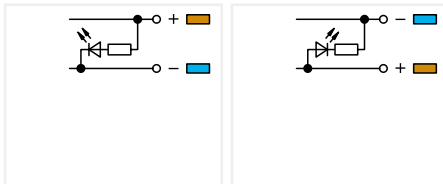
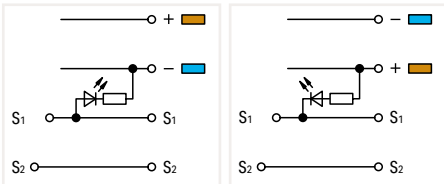
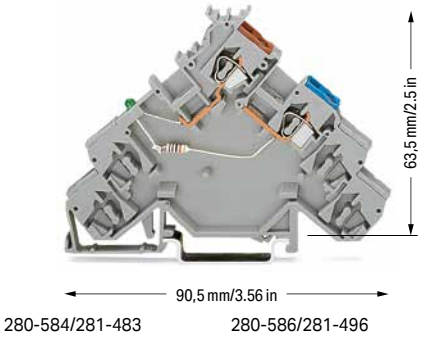

Sensor LED terminal block; for PNP (high-side) switching sensors; red LED; LED power consumption: 4.8 mA

Sensor LED supply terminal block; power supply from sensor side; for PNP (high-side) switching sensors; green LED; LED power consumption: 4.8 mA

Color	Item No.	Pack. Unit
○ gray	280-580/281-434	50

Color	Item No.	Pack. Unit
○ gray	280-584/281-483	10

Sensor LED terminal block; for NPN (low-side) switching sensors; red LED; LED power consumption: 4.8 mA

Sensor LED supply terminal block; power supply from sensor side; for NPN (low-side) switching sensors; green LED; LED power consumption: 4.8 mA

○ gray	280-581/281-413	50
--------	-----------------	----

○ gray	280-586/281-496	10
--------	-----------------	----

Accessories; 280 Series

Appropriate marking system: WMB

End and intermediate plate; 1 mm thick; for quadruple-deck terminal blocks

orange	280-323	100 (25)
gray	280-320	100 (25)

Insulation stop; 0.75 ... 1 mm²; 5 pcs/strip

dark gray	280-472	200 (25)
-----------	---------	----------

Insulation stop; 0.08 ... 0.2 mm² "s" (0.14 mm² "f-st"); 5 pcs/strip

white	280-470	200 (25)
-------	---------	----------

Adjacent jumper; insulated; I_N = I_N terminal block

gray	280-402	200 (25)
------	---------	----------

Insulation stop; 0.25 ... 0.5 mm²; 5 pcs/strip

light gray	280-471	200 (25)
------------	---------	----------

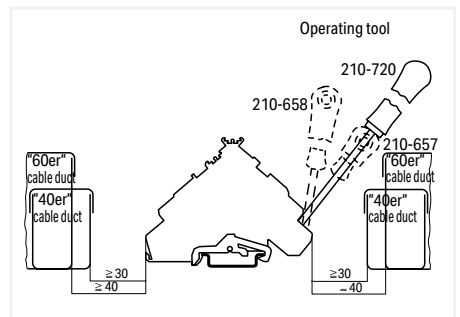

Min. mounting distance – terminal blocks to cable duct

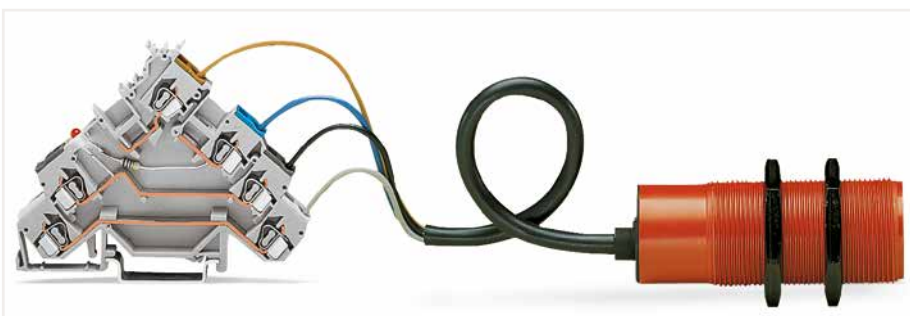

Sensor LED terminal block paired with a 4-conductor sensor

Actuator terminal block; for pressure and thermo switches

2.5 mm²; 280 Series

Technical Data	
0.08 ... 2.5 mm ²	28 ... 12 AWG*
400 V/6 kV/3 ①	300 V, 15 A ②
I _N 20 A	300 V, 15 A ③
Terminal block width: 5 mm / 0.197 inch	
8 ... 9 mm / 0.31 ... 0.35 inch	

Technical Data	
0.08 ... 2.5 mm ²	28 ... 12 AWG*
400 V/6 kV/3 ①	300 V, 15 A ②
I _N 20 A	300 V, 15 A ③
Terminal block width: 6 mm / 0.236 inch	
8 ... 9 mm / 0.31 ... 0.35 inch	

*12 AWG: THHN, THWN

- ① 400 V = rated voltage
- ② 6 kV = rated impulse voltage
- ③ 3 = pollution degree (see Section 15)

Please observe the application notes:
Insulation stop, see page 346
Marking, from page 640

Approvals and corresponding ratings, visit www.wago.com

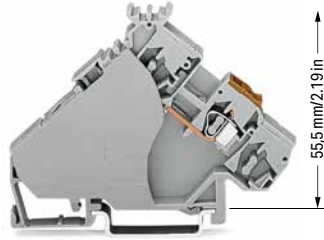
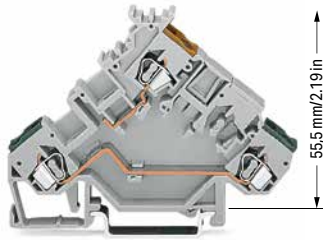

80 mm/3.15 in

80 mm/3.15 in

280-555

280-554

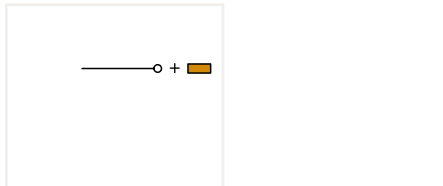
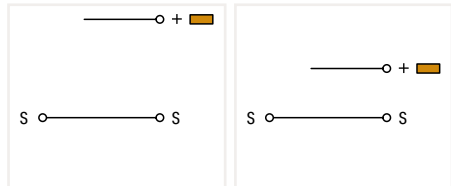

Actuator terminal block

Color	Item No.	Pack. Unit
○ gray	280-555	50

Actuator supply terminal block; in connection with 280-555: power supply from control panel side; in connection with 280-554: power supply from actuator side; with end plate

Color	Item No.	Pack. Unit
○ gray	280-556	20

Actuator terminal block

○ gray	280-554	50
--------	---------	----

Accessories; 280 Series

Appropriate marking system: WMB

End and intermediate plate; 1 mm thick; for triple-deck terminal blocks

	orange	280-321	100 (25)
	gray	280-319	100 (25)

Insulation stop; 0.75 ... 1 mm²; 5 pcs/strip

	dark gray	280-472	200 (25)
--	-----------	---------	----------

Insulation stop; 0.08 ... 0.2 mm² "s" (0.14 mm² "f-st"); 5 pcs/strip

	white	280-470	200 (25)
--	-------	---------	----------

Adjacent jumper; insulated; I_N = I_N terminal block

	gray	280-402	200 (25)
--	------	---------	----------

Insulation stop; 0.25 ... 0.5 mm²; 5 pcs/strip

	light gray	280-471	200 (25)
--	------------	---------	----------

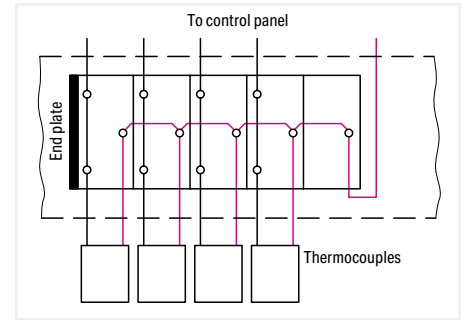

Power supply from actuator side

6

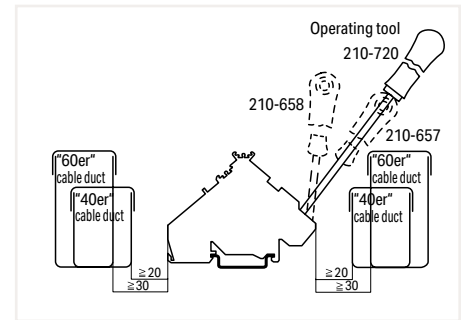

Min. mounting distance – terminal blocks to cable duct

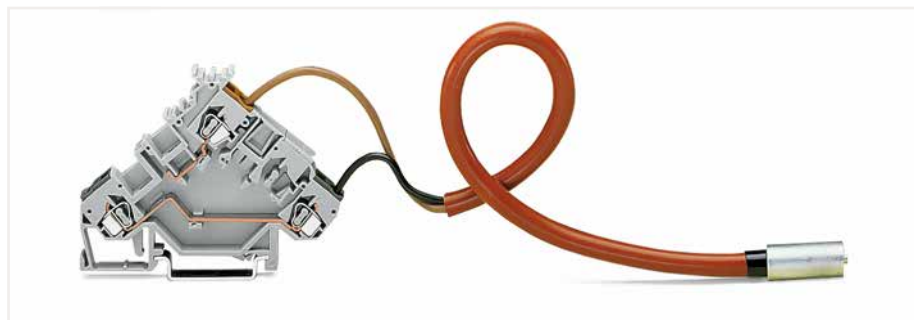

Actuator terminal block with thermocouple

Actuator terminal block; for Magnetic Valves and Servo Motors 2.5 mm²; 280 Series

Technical Data	
0.08 ... 2.5 mm ²	28 ... 12 AWG*
400 V/6 kV/3; 20 A ① ②	300 V, 15 A ④
250 V/4 kV/3; 20 A ① ②	300 V, 15 A ⑥
Terminal block width: 5 mm / 0.197 inch	
8 ... 9 mm / 0.31 ... 0.35 inch	

Technical Data	
0.08 ... 2.5 mm ²	28 ... 12 AWG*
125 V / 5 A ②	300 V, 6 A ④
250 V / 6.3 A ②	300 V, 15 A ⑥
Terminal block width: 5 mm / 0.197 inch	
8 ... 9 mm / 0.31 ... 0.35 inch	

Technical Data	
0.08 ... 2.5 mm ²	28 ... 12 AWG*
400 V/6 kV/3 ①	300 V, 10 A ④
I _N 10 A	300 V, 15 A ⑥
Terminal block width: 5 mm / 0.197 inch	
8 ... 9 mm / 0.31 ... 0.35 inch	

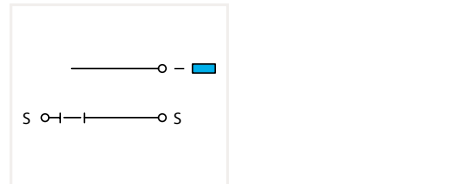
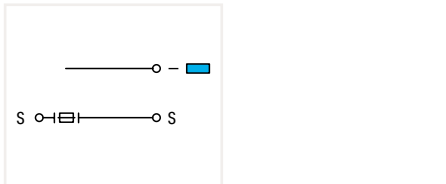
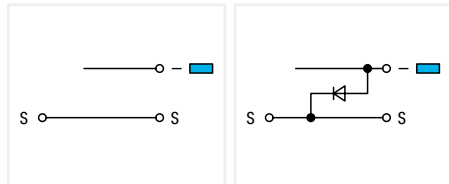
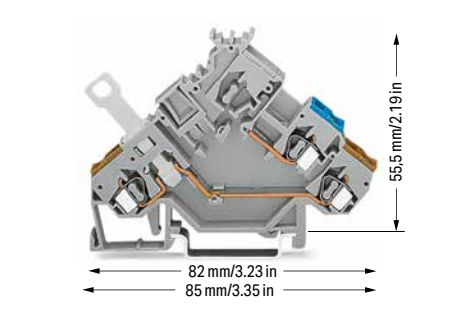
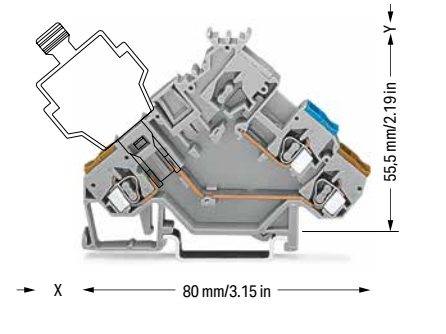
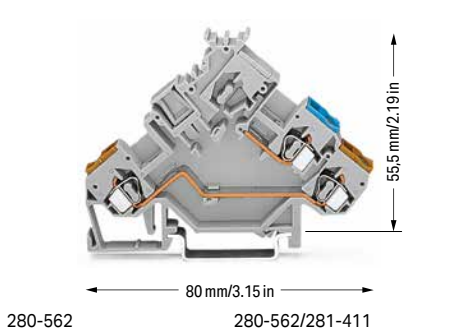

Actuator terminal block		
Color	Item No.	Pack. Unit
○ gray	280-562	50

Actuator terminal block; for fuse plugs; for phase protection; without end plate		
Color	Item No.	Pack. Unit
○ gray	280-565 ③	50

Actuator disconnect terminal block; for phase interruption		
Color	Item No.	Pack. Unit
○ gray	280-566	50

Actuator terminal block; with 1N4007 recovery diode		
Color	Item No.	Pack. Unit
○ gray	280-562/281-411	50

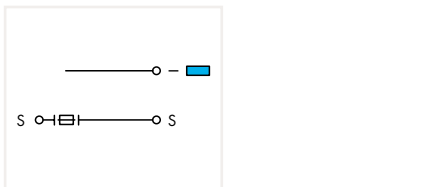
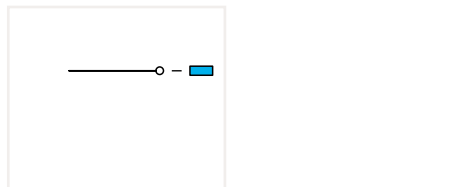
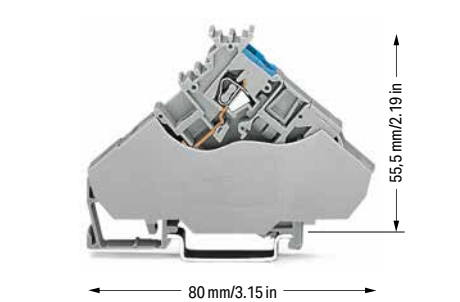
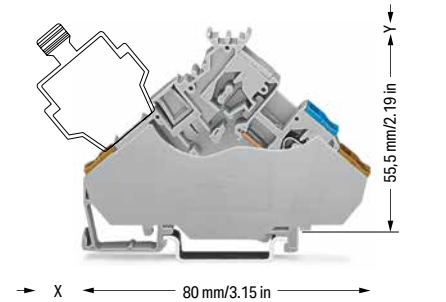
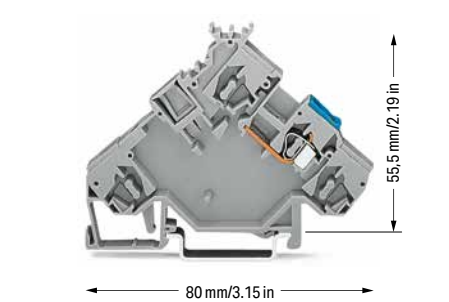

Actuator supply terminal block; power supply from actuator side		
Color	Item No.	Pack. Unit
○ gray	280-592	10

Actuator terminal block; for fuse plugs; for phase protection; with gray end plate		
Color	Item No.	Pack. Unit
○ gray	280-565/281-319	50
Terminal block width: 6 mm / 0.236 inch		

Actuator supply terminal block; power supply from control panel side; with end plate		
Color	Item No.	Pack. Unit
○ gray	280-568	20
Terminal block width: 6 mm / 0.236 inch		

Actuator terminal block; for fuse plugs; for phase protection; with orange end plate		
Color	Item No.	Pack. Unit
○ gray	280-565/281-321	50
Terminal block width: 6 mm / 0.236 inch		

Technical Data		
400 V/6 kV/3	I _N 20 A	

6

*12 AWG: THHN, THWN

- 1 400 V / 250 V = rated voltage
6 kV / 4 kV = rated impulse voltage
3 = pollution degree
(see Section 15)
- 2 Electrical ratings are given by the fuse plug or empty component plug housing.
- 3 Empty component plug housings, see Full Line Catalog, Interface Modules, Volume 4
x = 12 mm/0.472 inch
Fuse plug (281-511), see page 338
y = 15.5 mm/0.61 inch
x = 10 mm/0.394 inch

Please observe the application notes:
Insulation stop, see page 346
Marking, from page 640

Approvals and corresponding ratings,
visit www.wago.com

Accessories; 280 Series

Appropriate marking system:
WMB

End and intermediate plate; 1 mm thick; for triple-deck terminal blocks

	orange	280-321	100 (25)
	gray	280-319	100 (25)

Insulation stop; 0.08 ... 0.2 mm² "s" (0.14 mm² "f-st"); 5 pcs/strip

	white	280-470	200 (25)
---	-------	---------	----------

Insulation stop; 0.25 ... 0.5 mm²; 5 pcs/strip

	light gray	280-471	200 (25)
---	------------	---------	----------

Insulation stop; 0.75 ... 1 mm²; 5 pcs/strip

	dark gray	280-472	200 (25)
---	-----------	---------	----------

Adjacent jumper; insulated; I_N = I_N terminal block

	gray	280-402	200 (25)
---	------	---------	----------



Sensor terminal block paired with a 3-conductor sensor

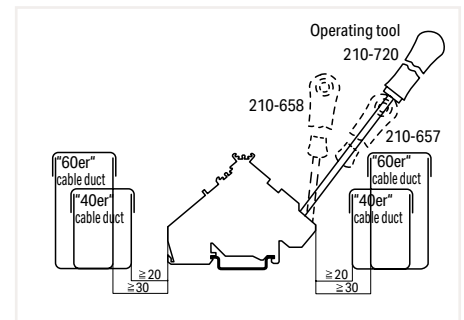

Min. mounting distance – terminal blocks to cable duct

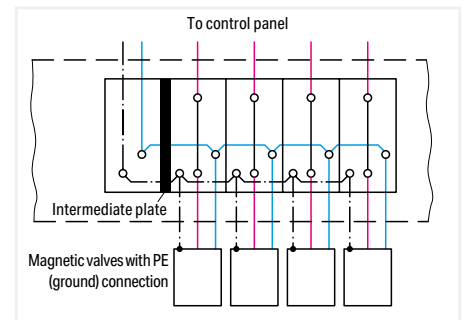
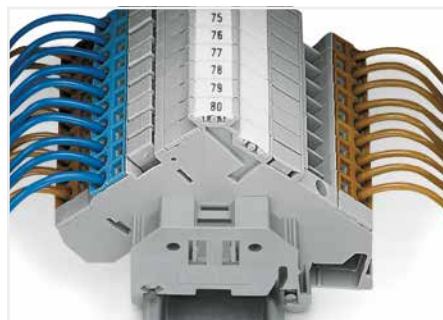

Power supply from control panel side

Actuator terminal block; with ground connection; for magnetic valves and servo motors 2.5 mm²; 280 Series

Technical Data	
0.08 ... 2.5 mm ²	28 ... 12 AWG*
400 V/6 kV/3; 20 A ① ②	300 V, 15 A ④
250 V/4 kV/3; 20 A ① ②	300 V, 15 A ⑥
Terminal block width: 5 mm / 0.197 inch	
8 ... 9 mm / 0.31 ... 0.35 inch	



280-572
280-572/281-411

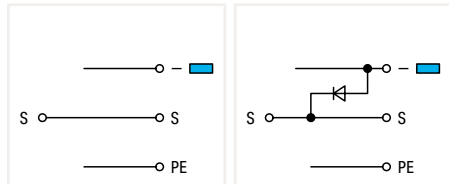

Actuator terminal block; with ground connection

Color	Item No.	Pack. Unit
○ gray	280-572	50

Actuator terminal block; with ground connection; with 1N4007 recovery diode

Color	Item No.	Pack. Unit
○ gray	280-572/281-411	50

Technical Data	
0.08 ... 2.5 mm ²	28 ... 12 AWG*
125 V / 5 A ②	300 V, 6 A ④
250 V / 6.3 A ②	300 V, 15 A ⑥
Terminal block width: 5 mm / 0.197 inch	
8 ... 9 mm / 0.31 ... 0.35 inch	

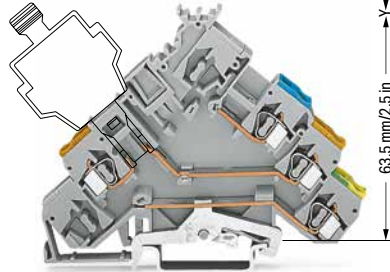

90,5 mm/3.56 in



Actuator terminal block; with ground connection; for fuse plugs; for phase protection; without end plate

Color	Item No.	Pack. Unit
○ gray	280-575 ③	50

Technical Data	
0.08 ... 2.5 mm ²	28 ... 12 AWG*
400 V/6 kV/3 ①	300 V, 10 A ④
I _N 10 A	300 V, 15 A ⑥
Terminal block width: 5 mm / 0.197 inch	
8 ... 9 mm / 0.31 ... 0.35 inch	

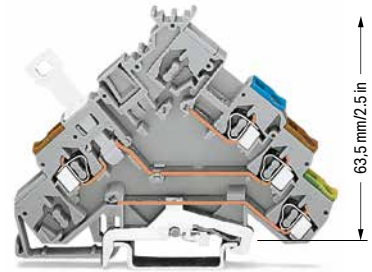

90,5 mm/3.56 in

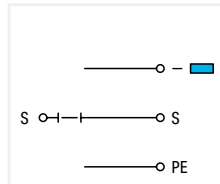

Actuator disconnect terminal block; with ground connection; for phase interruption

Color	Item No.	Pack. Unit
○ gray	280-576	50

6

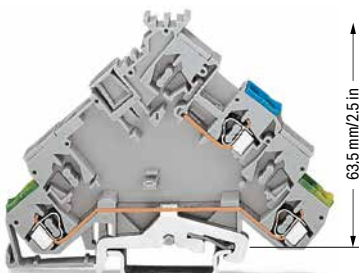

90,5 mm/3.56 in



Actuator supply terminal block; with ground connection; power supply from actuator side

Color	Item No.	Pack. Unit
○ gray	280-593	10

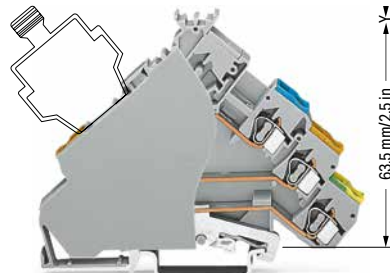

90,5 mm/3.56 in



Actuator terminal block; with ground connection; for fuse plugs; for phase protection; with end plate

Color	Item No.	Pack. Unit
○ gray	280-575/281-320	50

Actuator terminal block; with ground connection; for fuse plugs; for phase protection; with orange end plate

Color	Item No.	Pack. Unit
○ gray	280-575/281-323	50

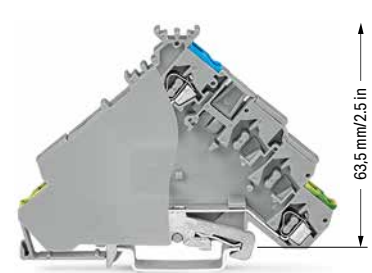

90,5 mm/3.56 in

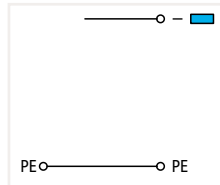

Actuator supply terminal block; with ground connection; power supply from control panel side; with end plate

Color	Item No.	Pack. Unit
○ gray	280-578	20

Technical Data

400 V/6 kV/3	I _N 20 A
--------------	---------------------

*12 AWG: THHN, THWN

1 400 V / 250 V = rated voltage
6 kV / 4 kV = rated impulse voltage
3 = pollution degree
(see Section 15)

2 Electrical ratings are given by the fuse plug or empty component plug housing.

3 Empty component plug housings, see Full Line Catalog, Interface Modules, Volume 4
x = 12 mm/0.472 inch
Fuse plug (281-511), see page 338
x = 15.5 mm/0.61 inch
y = 10 mm/0.394 inch

Please observe the application notes:
Insulation stop, see page 346
Marking, from page 640

Approvals and corresponding ratings, visit www.wago.com

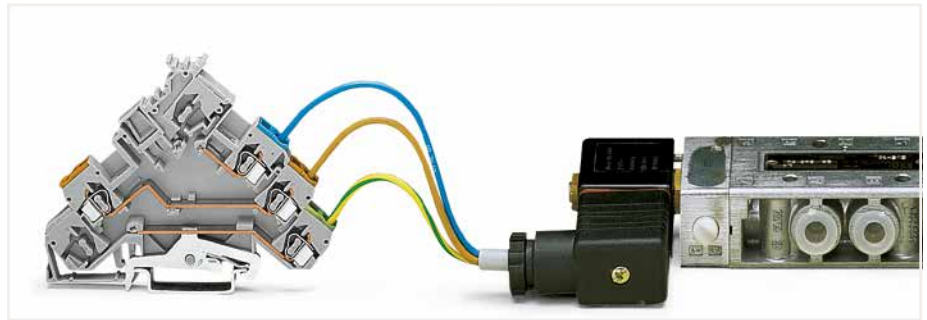



Actuator terminal block (ground connection) paired with a magnetic valve

Accessories; 280 Series

Appropriate marking system:
WMB

End and intermediate plate; 1 mm thick; for quadruple-deck terminal blocks

	orange	280-323	100 (25)
	gray	280-320	100 (25)

Insulation stop; 0.08 ... 0.2 mm² "s" (0.14 mm² "f-st"); 5 pcs/strip

	white	280-470	200 (25)
---	-------	---------	----------

Insulation stop; 0.25 ... 0.5 mm²; 5 pcs/strip

	light gray	280-471	200 (25)
---	------------	---------	----------

Insulation stop; 0.75 ... 1 mm²; 5 pcs/strip

	dark gray	280-472	200 (25)
---	-----------	---------	----------

Adjacent jumper; insulated; I_N = I_N terminal block

	gray	280-402	200 (25)
---	------	---------	----------

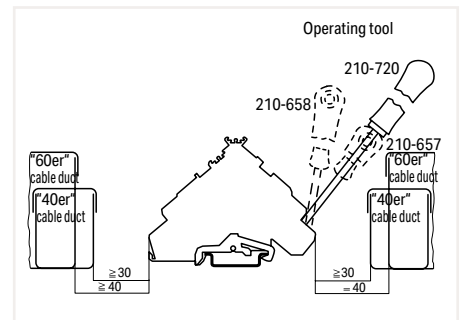

Min. mounting distance – terminal blocks to cable duct

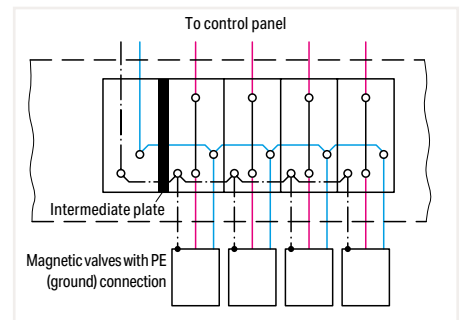
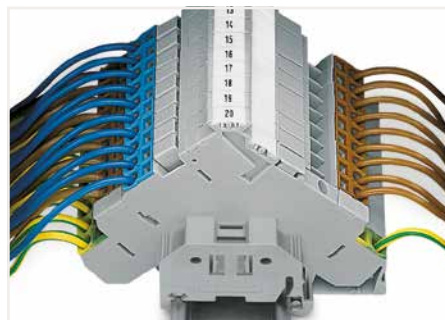

Power supply from control panel side

Actuator LED Terminal Block; with Ground Connection

2.5 mm²; 280 Series

Technical Data	
0.08 ... 2.5 mm ²	28 ... 12 AWG*
24 VDC ①	24 V, 15 A ②
20 A	300 V, 15 A ③
Terminal block width: 5 mm / 0.197 inch	
8 ... 9 mm / 0.31 ... 0.35 inch	

Technical Data	
0.08 ... 2.5 mm ²	28 ... 12 AWG*
24 VDC ①	24 V, 15 A ②
20 A	300 V, 15 A ③
Terminal block width: 5 mm / 0.197 inch	
8 ... 9 mm / 0.31 ... 0.35 inch	

*12 AWG: THHN, THWN

① Other voltages are available upon request.

Please observe the application notes:
Insulation stop, see page 346
Marking, from page 640

Approvals and corresponding ratings, visit www.wago.com

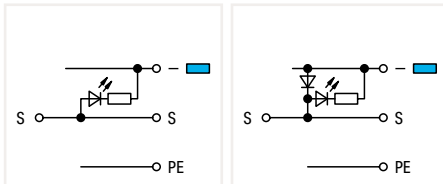
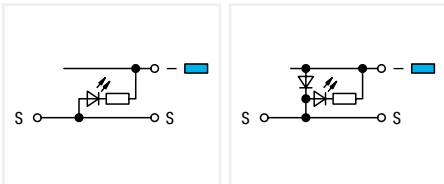
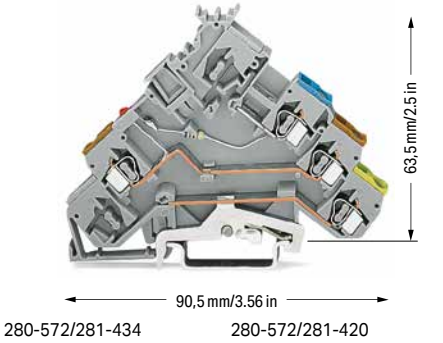
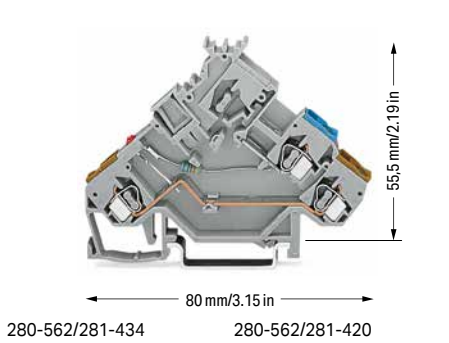

Actuator LED terminal block; red LED; LED power consumption: 4.8 mA

Color	Item No.	Pack. Unit
○ gray	280-562/281-434	50

Actuator LED terminal block; with ground connection; red LED; LED power consumption: 4.8 mA

Color	Item No.	Pack. Unit
○ gray	280-572/281-434	50

Actuator LED terminal block; with 1N4007 recovery diode; red LED; LED power consumption: 4.8 mA

Color	Item No.	Pack. Unit
○ gray	280-562/281-420	50

Actuator LED terminal block; with ground connection; with 1N4007 recovery diode; red LED; LED power consumption: 4.8 mA

Color	Item No.	Pack. Unit
○ gray	280-572/281-420	50

Accessories; item-specific
End and intermediate plate; 1 mm thick; for triple-deck terminal blocks

	orange	280-321	100 (25)
	gray	280-319	100 (25)

Accessories; item-specific
End and intermediate plate; 1 mm thick; for quadruple-deck terminal blocks

	orange	280-323	100 (25)
	gray	280-320	100 (25)

Accessories; 280 Series

Appropriate marking system: WMB

Insulation stop; 0.08 ... 0.2 mm² "s" (0.14 mm² "f-st"); 5 pcs/strip

	white	280-470	200 (25)
--	-------	---------	----------

Insulation stop; 0.75 ... 1 mm²; 5 pcs/strip

	dark gray	280-472	200 (25)
--	-----------	---------	----------

Insulation stop; 0.25 ... 0.5 mm²; 5 pcs/strip

	light gray	280-471	200 (25)
--	------------	---------	----------

Adjacent jumper; insulated; I_N = I_N terminal block

	gray	280-402	200 (25)
--	------	---------	----------

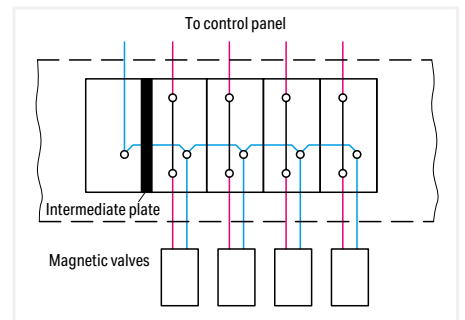
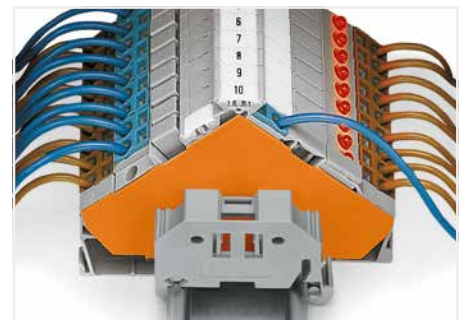

Power supply from control panel side

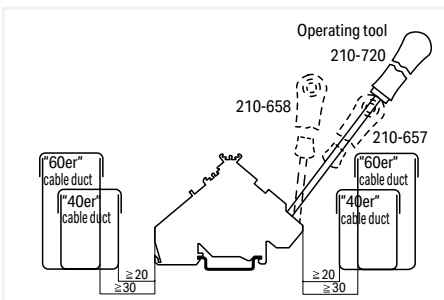

Min. mounting distance - terminal blocks to cable duct

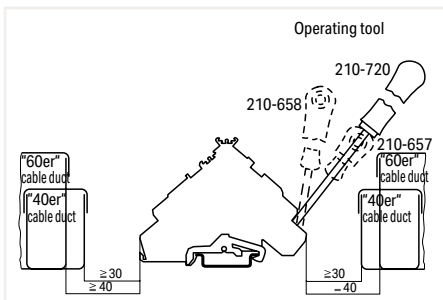

Min. mounting distance - terminal blocks to cable duct

Actuator Terminal Block for Actuators with Shield Connection and Actuators with Shield Conductor Through Contact (e.g., for Thermocouples) 2.5 mm²; 280 Series

Technical Data	
0.08 ... 2.5 mm ²	28 ... 12 AWG*
400 V/6 kV/3 ①	300 V, 15 A
I _N 20 A	300 V, 15 A @
Terminal block width: 5 mm / 0.197 inch	
8 ... 9 mm / 0.31 ... 0.35 inch	

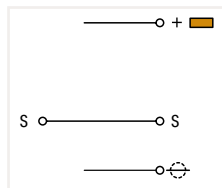

Actuator terminal block; with shield connection		
Color	Item No.	Pack. Unit
○ gray	280-585	50

Accessories; item-specific
see page 361

Technical Data	
0.08 ... 2.5 mm ²	28 ... 12 AWG*
400 V/6 kV/3 ①	300 V, 15 A
I _N 20 A	
Terminal block width: 5 mm / 0.197 inch	
8 ... 9 mm / 0.31 ... 0.35 inch	

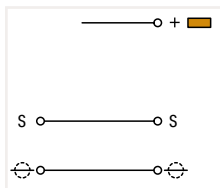

Actuator terminal block; with shield conductor through contact		
Color	Item No.	Pack. Unit
○ gray	280-583	50

Accessories; item-specific
see page 361

*12 AWG: THHN, THWN
① 400 V = rated voltage 6 kV = rated impulse voltage 3 = pollution degree (see Section 15)

Please observe the application notes:
Insulation stop, see page 346
Marking, from page 640

Approvals and corresponding ratings,
visit www.wago.com

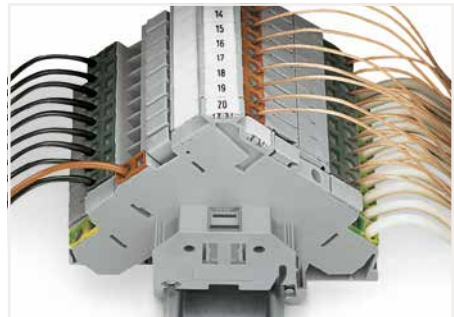

Power supply from control panel side

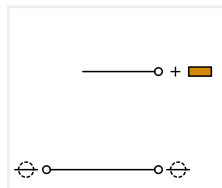
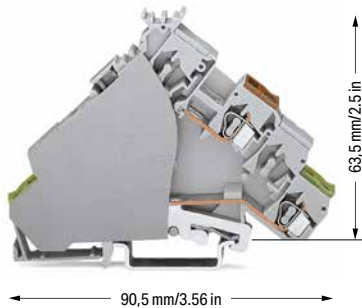

Actuator supply terminal block; with shield connection; power supply from control panel side; with end plate		
Color	Item No.	Pack. Unit
○ gray	280-586	10

Accessories; item-specific
see page 361

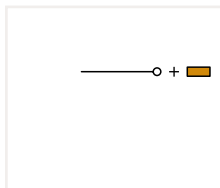
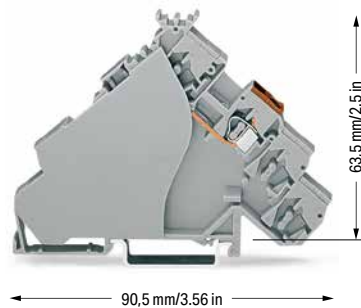

Actuator supply terminal block; power supply from control panel side; with end plate; for actuators with shield conductor through contact		
Color	Item No.	Pack. Unit
○ gray	280-515	50

Accessories; item-specific
see page 361



Power supply from control panel side

Diode Terminal Block and LED Terminal Block

1.5 mm²; 279 Series

Technical Data	
0.08 ... 1.5 mm ²	28 ... 16 AWG
U _N 250 V; U _{RM} 1000 V	
1N4007 – 0.5 A continuous current	
Terminal block width: 4 mm / 0.157 inch	
8 ... 9 mm / 0.31 ... 0.35 inch	

Technical Data	
0.08 ... 1.5 mm ²	28 ... 16 AWG
U _N 250 V; U _{RM} 1000 V	
1N4007 – 0.5 A continuous current	
Terminal block width: 4 mm / 0.157 inch	
8 ... 9 mm / 0.31 ... 0.35 inch	

Technical Data	
0.08 ... 1.5 mm ²	28 ... 16 AWG
24 VDC	
I _F 0.025 A max.	
Terminal block width: 4 mm / 0.157 inch	
8 ... 9 mm / 0.31 ... 0.35 inch	

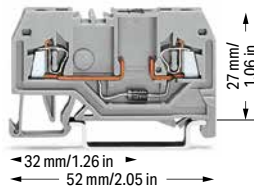

279-915/281-410 279-915/281-411

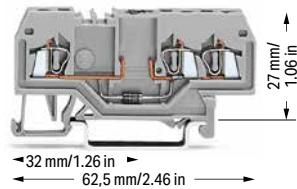

279-673/281-410 279-673/281-411

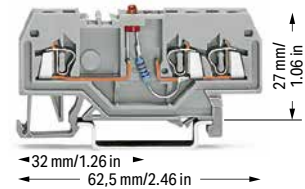

279-674/281-434 279-674/281-413

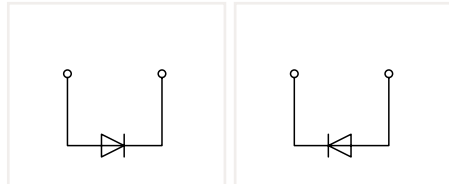

2-conductor diode terminal block; with 1N4007 diode; gray

	Item No.	Pack. Unit
○ anode left	279-915/281-410	100
○ anode right	279-915/281-411	100

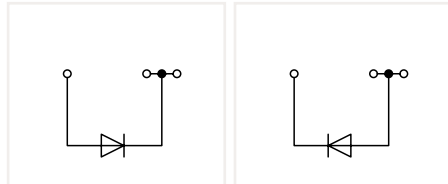

3-conductor diode terminal block; with 1N4007 diode; gray

	Item No.	Pack. Unit
○ anode left	279-673/281-410	100
○ anode right	279-673/281-411	100

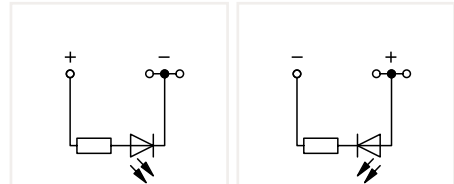

3-conductor LED terminal block; with red LED; gray

	Item No.	Pack. Unit
○ anode right	279-674/281-434	100
○ anode left	279-674/281-413	100

Other terminal blocks with the same profile:		
Through	279-901	Page 272

Other terminal blocks with the same profile:		
Through	279-681	Page 272

Other terminal blocks with the same profile:		
Through	279-681	Page 272

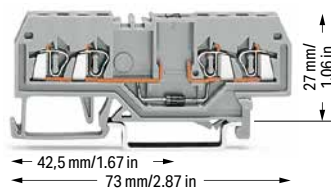

279-815/281-411 279-815/281-410

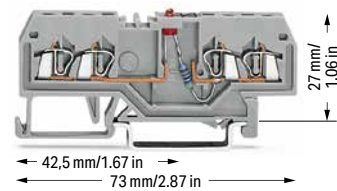

279-809/281-434 279-809/281-413

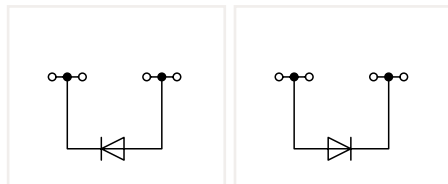

4-conductor diode terminal block; with 1N4007 diode; gray

	Item No.	Pack. Unit
○ anode right	279-815/281-411	100
○ anode left	279-815/281-410	100

Other terminal blocks with the same profile:		
Through	279-831	Page 272

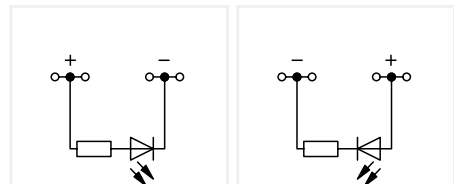

4-conductor LED terminal block; with red LED; gray

	Item No.	Pack. Unit
○ anode right	279-809/281-434	100
○ anode left	279-809/281-413	100

Other terminal blocks with the same profile:		
Through	279-831	Page 272

Diode Terminal Blocks and LED Terminal Blocks

Circuit Configuration Examples

Please observe the application notes:
 Insulation stop, page 382
 Comb-style jumper bar, page 383
 Marking, from page 640

Approvals and corresponding ratings,
 visit www.wago.com

Accessories; 279 Series
 Appropriate marking system:
 WMB/WMB Inline

Insulation stop; 0.08 ... 0.2 mm² "s" (0.14 mm² "f-st"); 5 pcs/strip

white	279-470	200 (25)
-------	---------	----------

Insulation stop; 0.25 mm²; 5 pcs/strip

dark gray	279-471	200 (25)
-----------	---------	----------

Comb-style jumper bar; insulated; I_N = I_N of terminal block

2-way	279-482	200 (25)
3-way	279-483	200 (25)

Comb-style jumper bar; insulated; I_N = I_N of terminal block

10-way	279-490	50 (25)
--------	---------	---------

Alternate comb-style jumper bar; insulated; I_N = I_N of terminal block

2-way	279-492	200 (25)
-------	---------	----------

Operating tool; insulated

2-way	279-432	1
3-way	279-433	1

Operating tool; insulated

10-way	279-440	1
--------	---------	---

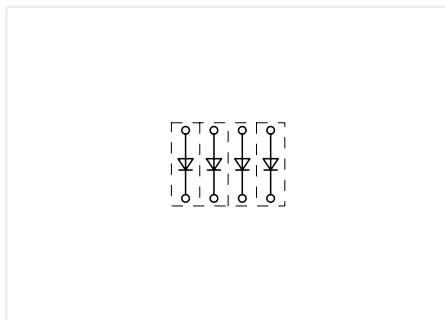

Open diode gates can be created using the following terminal blocks:
 279-915/281-410 or 279-915/281-411

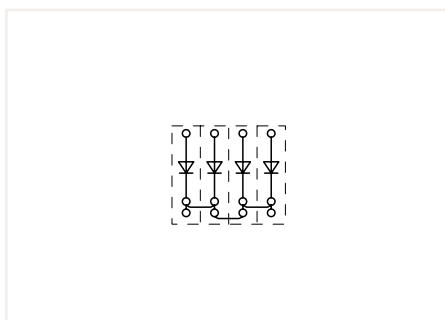

Polarized diode gates with a common cathode can be created using the following terminal blocks:
 279-673/281-410 or 279-673/281-411

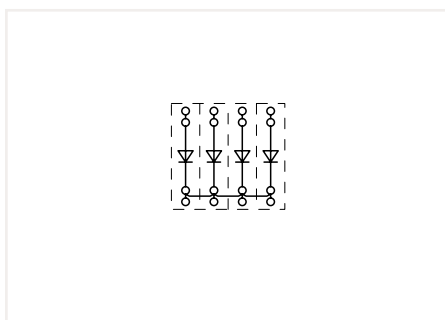

Polarized diode gates with a common cathode can be created using the following terminal blocks:
 279-815/281-410 or 279-815/281-411

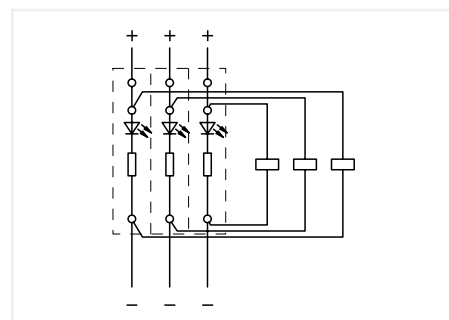

Circuit-related voltage indications can be created using the following terminal blocks:
 279-674/281-434 or 279-674/281-413

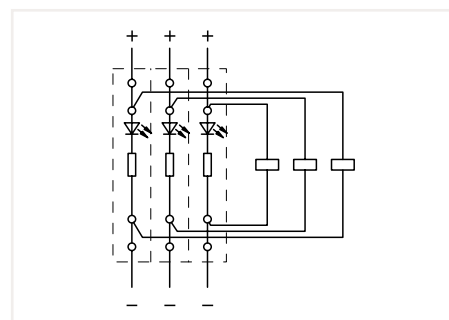

Circuit-related voltage indications can be created using the following terminal blocks:
 279-809/281-434 or 279-809/281-413

Diode Terminal Block and LED Terminal Block

2.5 mm²; 280 Series

Technical Data	
0.08 ... 2.5 mm ²	28 ... 14 AWG
U _N 250 V; U _{RM} 1000 V	
1N4007 – 0.5 A continuous current	
Terminal block width: 5 mm / 0.197 inch	
8 ... 9 mm / 0.31 ... 0.35 inch	

Technical Data	
0.08 ... 2.5 mm ²	28 ... 14 AWG
U _N 250 V; U _{RM} 1000 V	
1N4007 – 0.5 A continuous current	
Terminal block width: 5 mm / 0.197 inch	
8 ... 9 mm / 0.31 ... 0.35 inch	

Technical Data	
0.08 ... 2.5 mm ²	28 ... 14 AWG
24 VDC	
I _F 0.025 A max.	
Terminal block width: 5 mm / 0.197 inch	
8 ... 9 mm / 0.31 ... 0.35 inch	

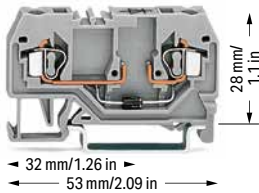

280-915/281-410 280-915/281-411

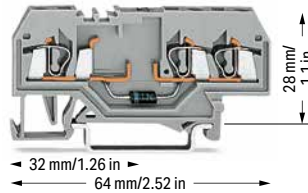

280-673/281-410 280-673/281-411

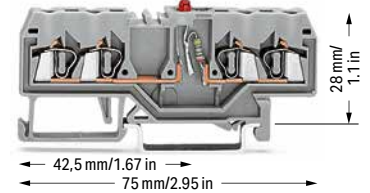

280-809/281-434 280-809/281-413

6

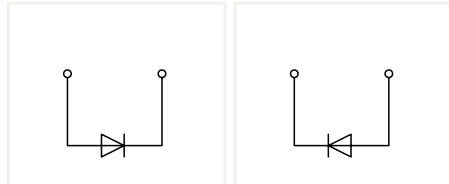

2-conductor diode terminal block; with 1N4007 diode; gray

	Item No.	Pack. Unit
○ anode left	280-915/281-410	100
○ anode right	280-915/281-411	100

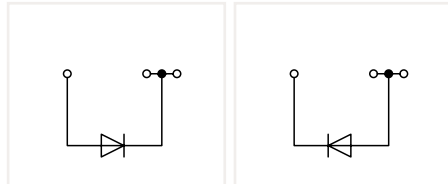

3-conductor diode terminal block; with 1N4007 diode; gray

	Item No.	Pack. Unit
○ anode left	280-673/281-410	100
○ anode right	280-673/281-411	100

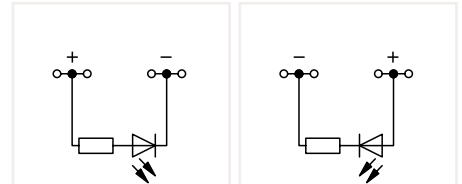

4-conductor LED terminal block; with red LED; gray

	Item No.	Pack. Unit
○ anode right	280-809/281-434	100
○ anode left	280-809/281-413	100

Other terminal blocks with the same profile:		
Through	280-901	Page 274

Other terminal blocks with the same profile:		
Through	280-681	Page 274

Other terminal blocks with the same profile:		
Through	280-833	Page 274

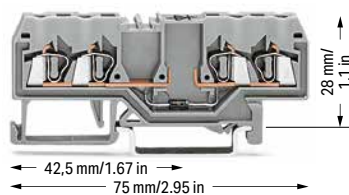

280-815/281-410 280-815/281-411

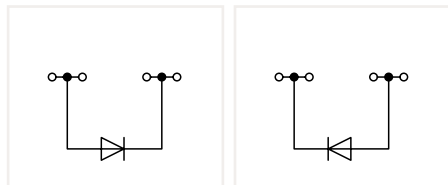

4-conductor diode terminal block; with 1N4007 diode; gray

	Item No.	Pack. Unit
○ anode left	280-815/281-410	100
○ anode right	280-815/281-411	100

Other terminal blocks with the same profile:		
Through	280-833	Page 274

Diode Terminal Blocks and LED Terminal Blocks

Circuit Configuration Examples

Please observe the application notes:
 Insulation stop, page 382
 Comb-style jumper bar, page 383
 Marking, from page 640

Approvals and corresponding ratings,
 visit www.wago.com

Accessories; 280 Series

Appropriate marking system:
 WMB/WMB Inline

Insulation stop; 0.08 ... 0.2 mm² "s" (0.14 mm² "f-st"); 5 pcs/strip

	white	280-470	200 (25)
---	-------	---------	----------

Insulation stop; 0.25 ... 0.5 mm²; 5 pcs/strip

	light gray	280-471	200 (25)
---	------------	---------	----------

Insulation stop; 0.75 ... 1 mm²; 5 pcs/strip

	dark gray	280-472	200 (25)
---	-----------	---------	----------

Comb-style jumper bar; insulated; I_N = I_N of terminal block

	2-way	280-482	200 (25)
	3-way	280-483	200 (25)

Comb-style jumper bar; insulated; I_N = I_N of terminal block

	10-way	280-490	50 (25)
---	--------	---------	---------

Alternate comb-style jumper bar; insulated; I_N = I_N of terminal block

	2-way	280-492	200 (25)
---	-------	---------	----------

Operating tool; insulated

	2-way	280-432	1
	3-way	280-433	1

Operating tool; insulated

	10-way	280-440	1
---	--------	---------	---

Wire commoning chain; insulated; 50 connections; I_N 8 A

	black	210-103	5
---	-------	---------	---

Wire commoning chain; insulated; 50 connections; I_N 8 A

	blue	210-123	5
---	------	---------	---

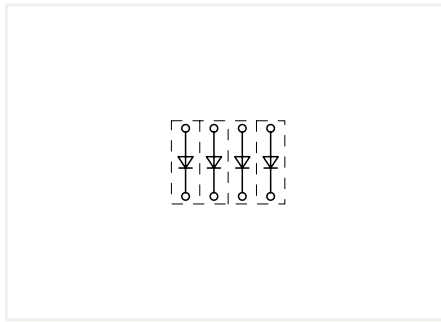

Open diode gates can be created using the following terminal blocks:
 280-915/281-410 or 280-915/281-411

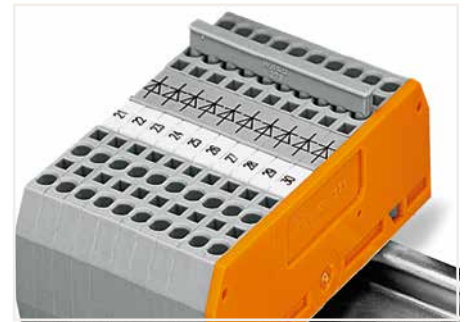

These diode terminal blocks have been specially developed for custom diode circuits, such as lamp test and collective fault signal circuits.

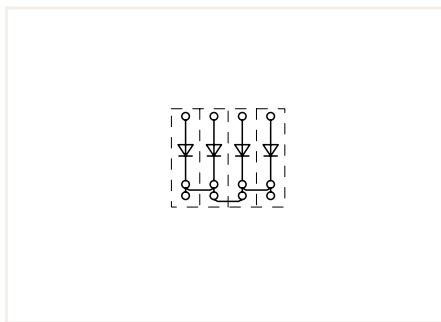

Polarized diode gates with a common cathode can be created using the following terminal blocks:
 280-673/281-410 or 280-673/281-411

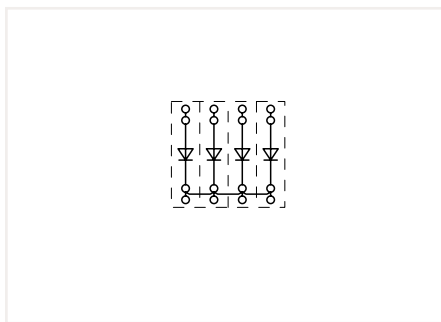

Polarized diode gates with a common cathode can be created using the following terminal blocks:
 280-815/281-410 or 280-815/281-411

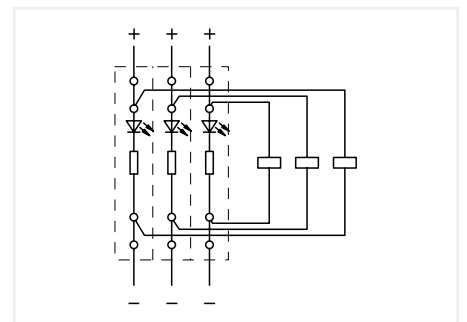

Circuit-related voltage indications can be created using the following terminal blocks:
 280-809/281-434 or 280-809/281-413

Diode Terminal Block

4 mm²; 281 Series

Technical Data	
0.08 ... 4 mm ²	28 ... 12 AWG
U _N 250 V; U _{RM} 1000 V	
Terminal block width: 6 mm / 0.236 inch	
9 ... 10 mm / 0.35 ... 0.39 inch	

Technical Data	
0.08 ... 4 mm ²	28 ... 12 AWG
U _N 250 V; U _{RM} 1000 V	
Terminal block width: 6 mm / 0.236 inch	
9 ... 10 mm / 0.35 ... 0.39 inch	

Technical Data	
0.08 ... 4 mm ²	28 ... 12 AWG
U _N 250 V; U _{RM} 1000 V	
Terminal block width: 6 mm / 0.236 inch	
9 ... 10 mm / 0.35 ... 0.39 inch	

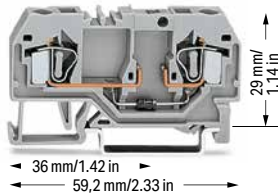

281-915/281-410 281-915/281-411

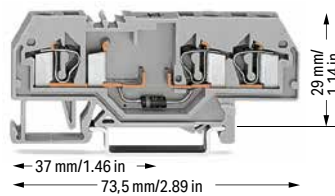

281-673/281-410 281-673/281-411

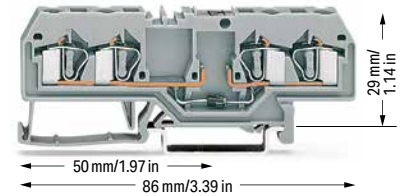

281-665/281-410 281-665/281-410

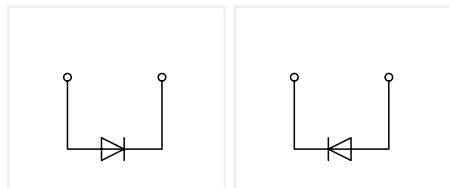

2-conductor diode terminal block; with 1N4007 diode; 0.5 A continuous current; gray

	Item No.	Pack. Unit
○ anode left	281-915/281-410	50
○ anode right	281-915/281-411	50

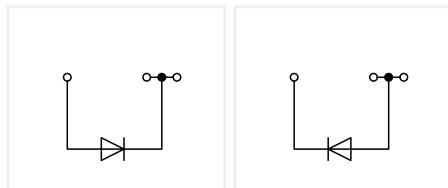

3-conductor diode terminal block; with 1N4007 diode; 0.5 A continuous current; gray

	Item No.	Pack. Unit
○ anode left	281-673/281-410	50
○ anode right	281-673/281-411	50

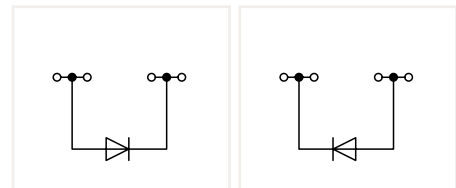

4-conductor diode terminal block; with 1N4007 diode; 0.5 A continuous current; gray

	Item No.	Pack. Unit
○ anode left	281-665/281-410	50
○ anode right	281-665/281-411	50

2-conductor diode terminal block; with 1N5408 diode; 1.5 A continuous current; gray

	Item No.	Pack. Unit
○ anode left	281-915/281-400	50
○ anode right	281-915/281-401	50

3-conductor diode terminal block; with 1N5408 diode; 1.5 A continuous current; gray

	Item No.	Pack. Unit
○ anode left	281-673/281-400	50
○ anode right	281-673/281-401	50

4-conductor diode terminal block; with 1N5408 diode; 1.5 A continuous current; gray

	Item No.	Pack. Unit
○ anode left	281-665/281-400	50
○ anode right	281-665/281-401	50

Other terminal blocks with the same profile:		
Through	281-901	Page 278

Other terminal blocks with the same profile:		
Through	281-681	Page 278

Other terminal blocks with the same profile:		
Through	280-652	Page 278

6

Diode Terminal Blocks Circuit Configuration Examples

Please observe the application notes:
Insulation stop, page 382
Comb-style jumper bar, page 383
Marking, from page 640

Approvals and corresponding ratings,
visit www.wago.com

Accessories; 281 Series

Appropriate marking system:
WMB

Insulation stop; 0.08 ... 0.2 mm² "s" (0.14 mm² "f-st"); 5 pcs/strip

	white	281-470	200 (25)
---	-------	---------	----------

Insulation stop; 0.25 ... 0.5 mm²; 5 pcs/strip

	light gray	281-471	200 (25)
---	------------	---------	----------

Insulation stop; 0.75 ... 1.5 mm²; 5 pcs/strip

	dark gray	281-472	200 (25)
---	-----------	---------	----------

Comb-style jumper bar; insulated; I_N = I_N of terminal block

	2-way	281-482	100 (25)
	3-way	281-483	100 (25)
	5-way	281-485	100 (25)
	10-way	281-490	50 (25)

Alternate comb-style jumper bar; insulated; I_N = I_N of terminal block

	2-way	281-492	100 (25)
---	-------	---------	----------

Operating tool; insulated

	2-way	280-432	1
	3-way	280-433	1
	5-way	281-440	1

Wire commoning chain; insulated; 50 connections; I_N 8 A

	black	210-103	5
---	-------	---------	---

Wire commoning chain; insulated; 50 connections; I_N 8 A

	blue	210-123	5
---	------	---------	---

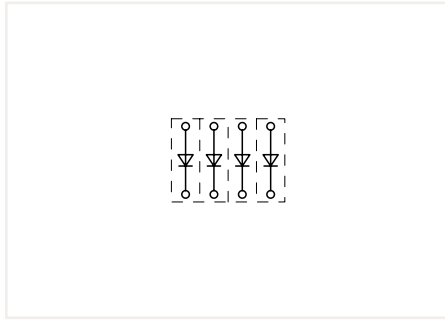

Open diode gates can be created using the following terminal blocks:
281-915/281-410 or 281-915/281-411

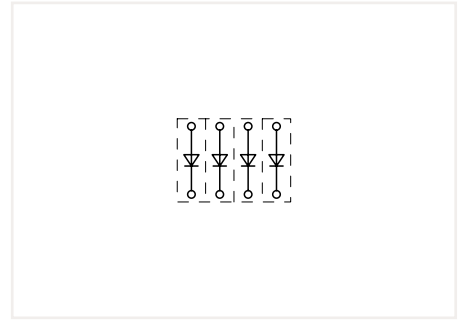

Open diode gates can be created using the following terminal blocks:
281-915/281-400 or 281-915/281-401

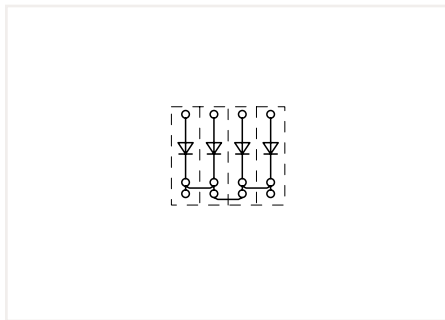

Polarized diode gates with a common cathode can be created using the following terminal blocks:
281-673/281-410 or 281-673/281-411

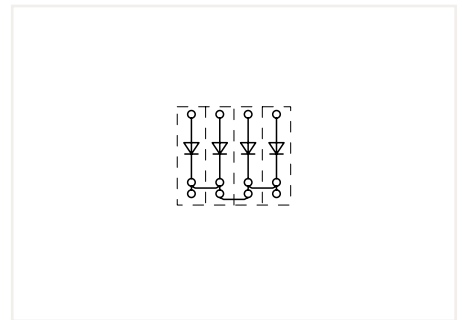

Polarized diode gates with a common cathode can be created using the following terminal blocks:
281-673/281-400 or 281-673/281-401

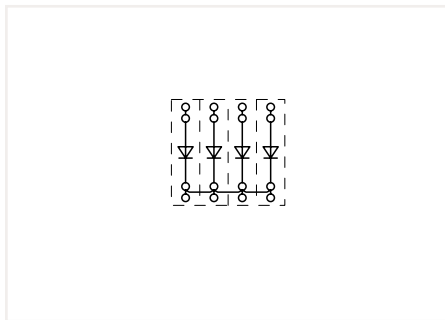

Polarized diode gates with a common cathode can be created using the following terminal blocks:
281-665/281-410 or 281-665/281-411

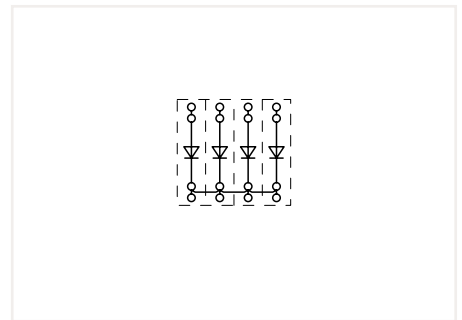

Polarized diode gates with a common cathode can be created using the following terminal blocks:
281-665/281-400 or 281-665/281-401

Double-Deck Diode Terminal Block and LED Terminal Block 2.5 mm²; 280 Series

Technical Data

0.08 ... 2.5 mm² | 28 ... 14 AWG

U_N 250 V; U_{RM} 1000 V

1N4007 – 0.5 A continuous current

Terminal block width: 5 mm / 0.197 inch

8 ... 9 mm / 0.31 ... 0.35 inch

Technical Data

0.08 ... 2.5 mm² | 28 ... 14 AWG

U_N 250 V; U_{RM} 1000 V

1N4007 – 0.5 A continuous current

Terminal block width: 5 mm / 0.197 inch

8 ... 9 mm / 0.31 ... 0.35 inch

Technical Data

0.08 ... 2.5 mm² | 28 ... 14 AWG

24 VDC

I_F 0.025 A max.

Terminal block width: 5 mm / 0.197 inch

8 ... 9 mm / 0.31 ... 0.35 inch

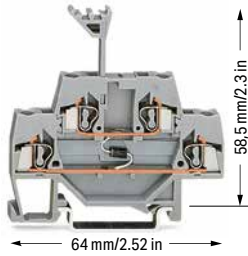

280-940/281-410 280-940/281-411

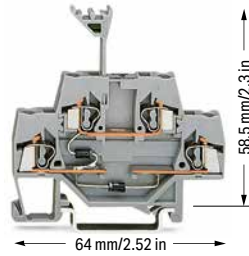

280-941/281-492 280-941/281-491

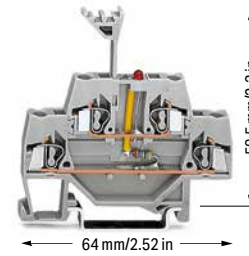

280-943/281-434 280-943/281-413

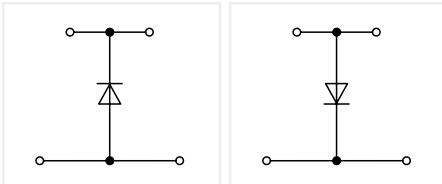

Double-deck diode terminal block; with 1N4007 diode; gray

	Item No.	Pack. Unit
○ anode bottom	280-940/281-410	50
○ anode top	280-940/281-411	50

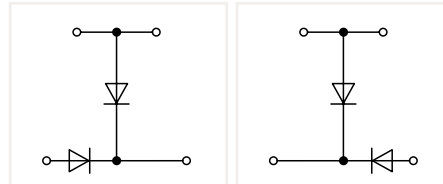

Double-deck diode terminal block; with two 1N4007 diodes; gray

	Item No.	Pack. Unit
○ anode top, anode left	280-941/281-492	50
○ anode top, anode right	280-941/281-491	50

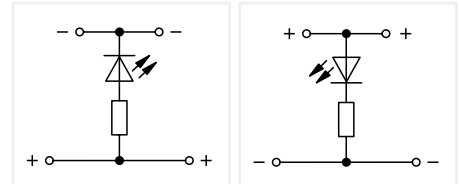

Double-deck LED terminal block; with red LED; gray

	Item No.	Pack. Unit
○ anode bottom	280-943/281-434	50
○ anode top	280-943/281-413	50

Other terminal blocks with the same profile:

Through	280-519	Page 292
---------	---------	----------

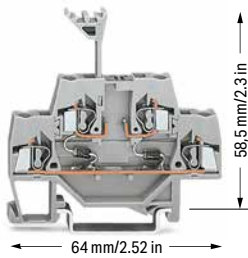

280-942/281-487 280-942/281-488

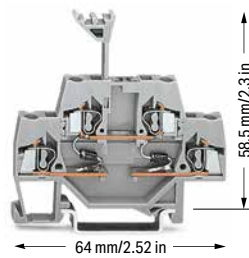

280-941/281-489 280-941/281-490

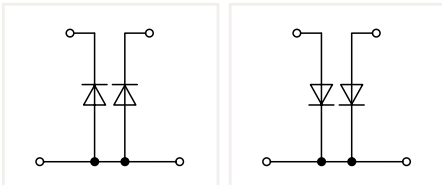

Double-deck diode terminal block; with two 1N4007 diodes; gray

	Item No.	Pack. Unit
○ anodes bottom	280-942/281-487	50
○ anodes top	280-942/281-488	50

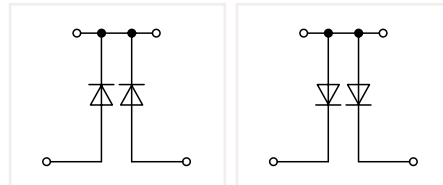

Double-deck diode terminal block; with two 1N4007 diodes; gray

	Item No.	Pack. Unit
○ anodes bottom	280-941/281-489	50
○ anodes top	280-941/281-490	50



Double-Deck Diode Terminal Blocks and LED Terminal Blocks Circuit Configuration Examples

Please observe the application notes:
Insulation stop, page 382
Comb-style jumper bar, page 383
Marking, from page 640

Approvals and corresponding ratings,
visit www.wago.com

Accessories; 280 Series
Appropriate marking system:
WMB

End and intermediate plate; 2.5 mm thick

	orange	280-341	100 (25)
	gray	280-340	100 (25)

Insulation stop; 0.08 ... 0.2 mm² "s" (0.14 mm² "f-st"); 5 pcs/strip

	white	280-470	200 (25)
---	-------	---------	----------

Insulation stop; 0.25 ... 0.5 mm²; 5 pcs/strip

	light gray	280-471	200 (25)
---	------------	---------	----------

Insulation stop; 0.75 ... 1 mm²; 5 pcs/strip

	dark gray	280-472	200 (25)
---	-----------	---------	----------

Comb-style jumper bar; insulated; I_N = I_N of terminal block

	2-way	280-482	200 (25)
	3-way	280-483	200 (25)

Comb-style jumper bar; insulated; I_N = I_N of terminal block

	10-way	280-490	50 (25)
---	--------	---------	---------

Alternate comb-style jumper bar; insulated; I_N = I_N of terminal block

	2-way	280-492	200 (25)
---	-------	---------	----------

Operating tool; insulated

	2-way	280-432	1
	3-way	280-433	1

Operating tool; insulated

	10-way	280-440	1
---	--------	---------	---

Wire commoning chain; insulated; 50 connections; I_N 8 A

	black	210-103	5
---	-------	---------	---

Wire commoning chain; insulated; 50 connections; I_N 8 A

	blue	210-123	5
---	------	---------	---

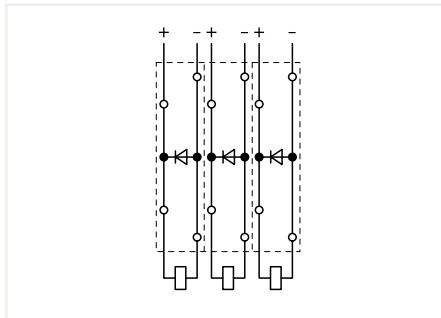

Recovery diodes can be created using the following terminal blocks:
280-940/281-410 or 280-940/281-411

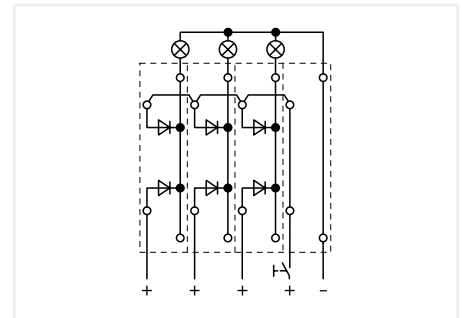

Lamp test circuits can be created using the following terminal blocks:
280-942/281-487 or 280-942/281-488

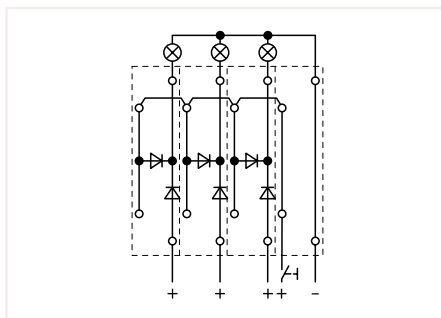

Lamp test circuits can be created using the following terminal blocks:
280-941/281-492 or 280-941/281-491

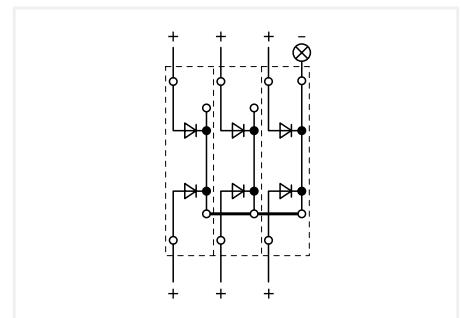

Collective fault signals can be created using the following terminal blocks:
280-941/281-489 or 280-941/281-490

Double-deck diode terminal blocks were specifically developed for custom diode circuits, such as lamp test and collective fault signal circuits. Using LED terminal blocks, monitoring units can be designed, e.g., for control and operating circuits. These terminal blocks provide high-density wiring in a width of just 5 mm.

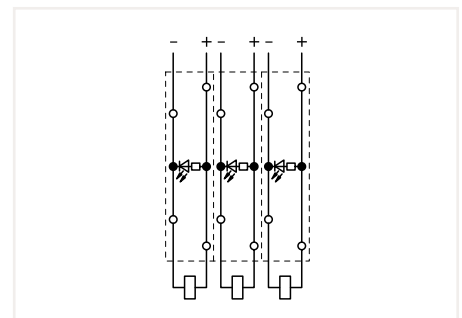

Circuit-related voltage indications can be created using the following terminal blocks:
280-943/281-434 or 280-943/281-413

Double-Deck Diode Terminal Block and LED Terminal Block 4 mm²; 281 Series

Technical Data	
0.08 ... 4 mm ²	28 ... 12 AWG
U _N 250 V; U _{RM} 1000 V	
1N4007 – 0.5 A continuous current	
Terminal block width: 6 mm / 0.236 inch	
9 ... 10 mm / 0.35 ... 0.39 inch	

Technical Data	
0.08 ... 4 mm ²	28 ... 12 AWG
U _N 250 V; U _{RM} 1000 V	
1N4007 – 0.5 A continuous current	
Terminal block width: 6 mm / 0.236 inch	
9 ... 10 mm / 0.35 ... 0.39 inch	

Technical Data	
0.08 ... 4 mm ²	28 ... 12 AWG
24 VDC	
I _F 0.025 A max.	
Terminal block width: 6 mm / 0.236 inch	
9 ... 10 mm / 0.35 ... 0.39 inch	

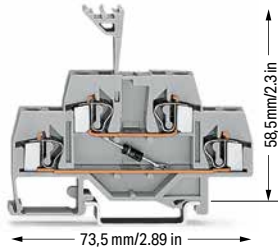

281-633/281-410

281-633/281-411

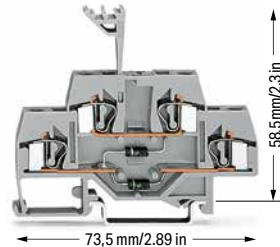

281-635/281-492

281-635/281-491

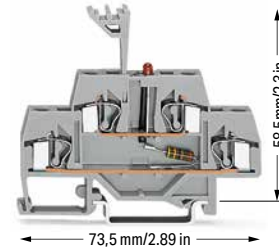

281-634/281-434

281-634/281-413

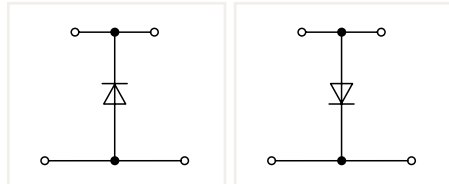

Double-deck diode terminal block; with 1N4007 diode; gray

	Item No.	Pack. Unit
○ anode bottom	281-633/281-410	50
○ anode top	281-633/281-411	50

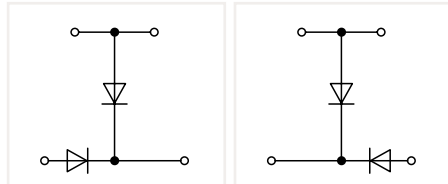

Double-deck diode terminal block; with two 1N4007 diodes; gray

	Item No.	Pack. Unit
○ anode top, anode left	281-635/281-492	50
○ anode top, anode right	281-635/281-491	50

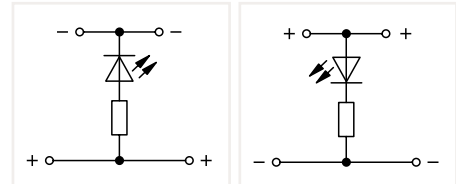

Double-deck LED terminal block; with red LED; gray

	Item No.	Pack. Unit
○ anode bottom	281-634/281-434	50
○ anode top	281-634/281-413	50

Other terminal blocks with the same profile:
Through **281-619** Page 296

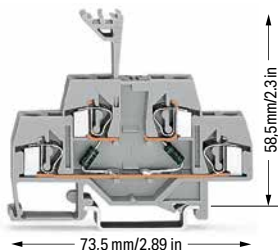

281-636/281-487

281-636/281-488

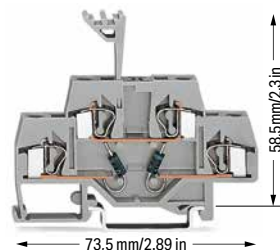

281-635/281-489

281-635/281-490

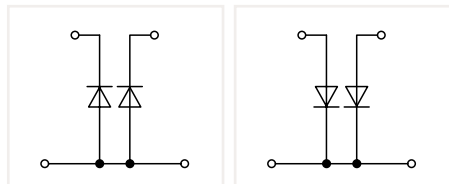

Double-deck diode terminal block; with two 1N4007 diodes; gray

	Item No.	Pack. Unit
○ anodes bottom	281-636/281-487	50
○ anodes top	281-636/281-488	50

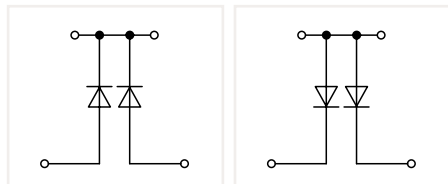

Double-deck diode terminal block; with two 1N4007 diodes; gray

	Item No.	Pack. Unit
○ anodes bottom	281-635/281-489	50
○ anodes top	281-635/281-490	50

Double-Deck Diode Terminal Blocks and LED Terminal Blocks Circuit Configuration Examples

Please observe the application notes:
Insulation stop, page 382
Comb-style jumper bar, page 383
Marking, from page 640

Approvals and corresponding ratings,
visit www.wago.com

Accessories; 280 Series
Appropriate marking system:
WMB

End and intermediate plate; 2.5 mm thick

orange	281-341	100 (25)
gray	281-340	100 (25)

Insulation stop; 0.08 ... 0.2 mm² "s" (0.14 mm² "f-st"); 5 pcs/strip

white	281-470	200 (25)
-------	---------	----------

Insulation stop; 0.25 ... 0.5 mm²; 5 pcs/strip

light gray	281-471	200 (25)
------------	---------	----------

Insulation stop; 0.75 ... 1.5 mm²; 5 pcs/strip

dark gray	281-472	200 (25)
-----------	---------	----------

Comb-style jumper bar; insulated; I_N = I_N of terminal block

2-way	281-482	100 (25)
3-way	281-483	100 (25)
5-way	281-485	100 (25)
10-way	281-490	50 (25)

Alternate comb-style jumper bar; insulated; I_N = I_N of terminal block

2-way	280-492	200 (25)
-------	---------	----------

Operating tool; insulated

2-way	280-432	1
3-way	280-433	1
5-way	281-440	1

Wire commoning chain; insulated; 50 connections; I_N 8 A

black	210-103	5
-------	---------	---

Wire commoning chain; insulated; 50 connections; I_N 8 A

blue	210-123	5
------	---------	---

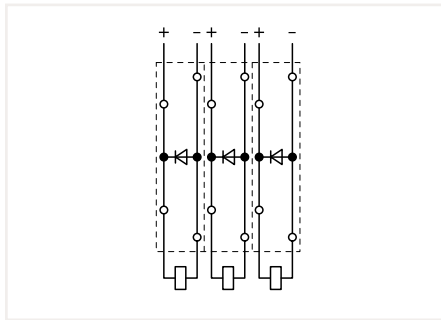

Recovery diodes can be created using the following terminal blocks:
281-633/281-410 or 281-633/281-411

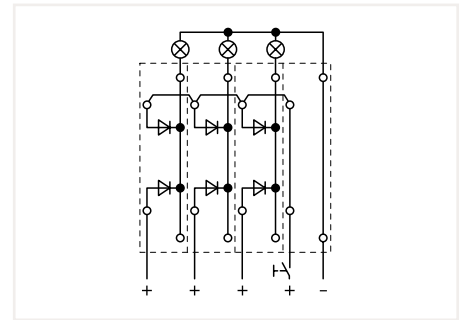

Lamp test circuits can be created using the following terminal blocks:
281-636/281-487 or 281-636/281-488

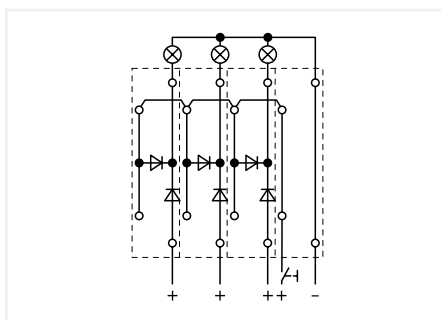

Lamp test circuits can be created using the following terminal blocks:
281-635/281-492 or 281-635/281-491

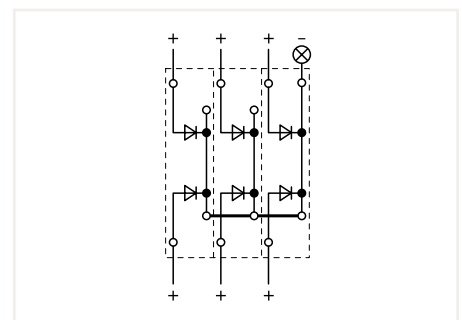

Collective fault signals can be created using the following terminal blocks:
281-635/281-489 or 281-635/281-490

Double-deck diode terminal blocks were specifically developed for custom diode circuits, such as lamp test and collective fault signal circuits. Using LED terminal blocks, monitoring units can be designed, e.g., for control and operating circuits. These terminal blocks provide high-density wiring in a width of just 6 mm.

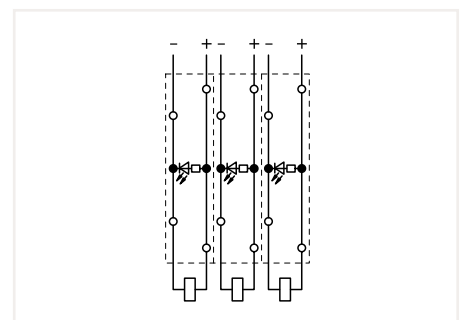

Circuit-related voltage indications can be created using the following terminal blocks:
281-634/281-434 or 281-634/281-413

Pluggable Diode Module on Carrier Terminal Block 2.5 mm² 280 Series

Technical Data

U_N 250 V; U_{RM} 1000 V
 I_N 0.5 A
 Plug width: 5 mm / 0.197 inch



*12 AWG: THHN, THWN

Please observe the application notes:
 Insulation stop, page 382
 Comb-style jumper bar, page 383
 Marking, from page 640

Approvals and corresponding ratings,
 visit www.wago.com

Accessories; 280 Series

Appropriate marking system:
 WMB

Insulation stop; 0.08 ... 0.2 mm² "s" (0.14 mm² "f-st"); 5 pcs/strip

white	280-470	200 (25)
-------	---------	----------

Insulation stop; 0.25 ... 0.5 mm²; 5 pcs/strip

light gray	280-471	200 (25)
------------	---------	----------

Insulation stop; 0.75 ... 1 mm²; 5 pcs/strip

dark gray	280-472	200 (25)
-----------	---------	----------

Comb-style jumper bar; insulated; $I_N = I_N$ of terminal block

2-way	280-482	200 (25)
3-way	280-483	200 (25)

Comb-style jumper bar; insulated; $I_N = I_N$ of terminal block

10-way	280-490	50 (25)
--------	---------	---------

Alternate comb-style jumper bar; insulated; $I_N = I_N$ of terminal block

2-way	280-492	200 (25)
-------	---------	----------

Operating tool; insulated

2-way	280-432	1
3-way	280-433	1

Operating tool; insulated

10-way	280-440	1
--------	---------	---

Wire commoning chain; insulated; 50 connections; I_N 8 A

black	210-103	5
-------	---------	---

Wire commoning chain; insulated; 50 connections; I_N 8 A

blue	210-123	5
------	---------	---

280-801/281-411

280-801/281-420

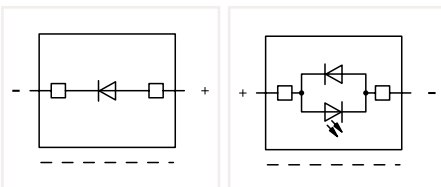

Diode module; with 1N4007 diode; 5 mm wide; gray

	Item No.	Pack. Unit
○ anode right	280-801/281-411	100

Diode module; with 1N4007 recovery diode; red LED; 5 mm wide; gray

○ 24 VDC	280-801/281-420	100
○ 48 VDC	280-801/281-421	100

Accessories; Carrier Terminal Blocks

Appropriate marking system:
 WMB

2-conductor carrier terminal block;
 0.08 ... 2.5 mm² / 28 ... 12 AWG*
 Terminal block width: 5 mm / 0.197 inch

gray	280-916	100
------	---------	-----

End and intermediate plate; 2.5 mm thick

orange	280-309	100 (25)
gray	280-308	100 (25)

3-conductor carrier terminal block;
 0.08 ... 2.5 mm² / 28 ... 12 AWG*
 Terminal block width: 5 mm / 0.197 inch

gray	280-610	100
------	---------	-----

End and intermediate plate; 2.5 mm thick

orange	280-326	100 (25)
gray	280-324	100 (25)

4-conductor carrier terminal block;
 0.08 ... 2.5 mm² / 28 ... 12 AWG*
 Terminal block width: 5 mm / 0.197 inch

gray	280-816	100
------	---------	-----

End and intermediate plate; 2.5 mm thick

orange	280-315	100 (25)
gray	280-314	100 (25)

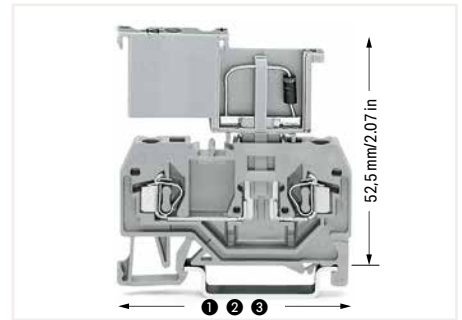

Lengths of carrier terminal blocks with a pluggable diode module:

- ① 53 mm / 2.09 inch for 280-916
- ② 64 mm / 2.52 inch for 280-610
- ③ 75 mm / 2.95 inch for 280-816

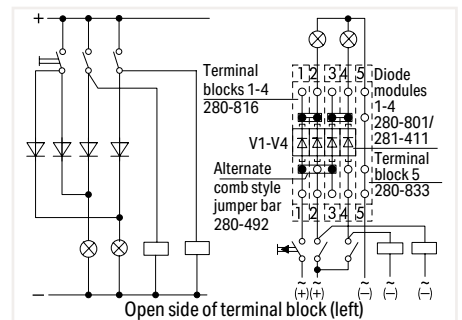

Lamp test circuit with blocking diodes

These diode modules are ideal for custom diode circuits (e.g., lamp test and collective fault signal circuits) and offer the following advantages:

- Separation into functional and wiring levels
- Polarized switching direction
- Quick and easy module replacement
- Terminal blocks/modules provide high-density wiring in a width of just 5 mm

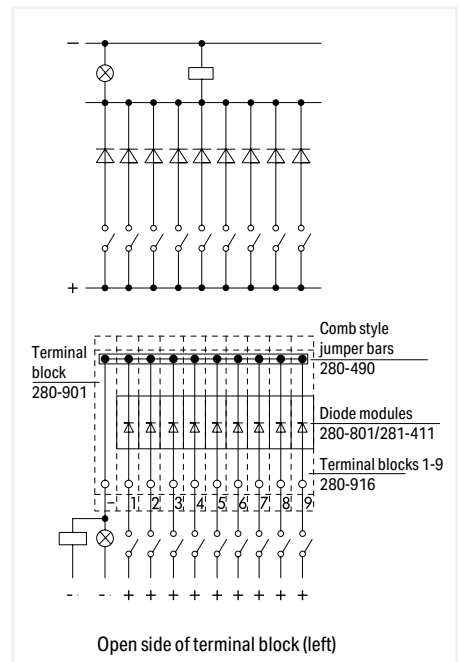

Diode gate for collective fault indication

Pluggable Diode Module on Through Terminal Block 2.5 mm² 280 Series

Technical Data

U_N 250 V; U_{RM} 1000 V
 I_N 0.5 A
 Plug width: 10 mm / 0.394 inch



280-803/281-411

280-803/281-420

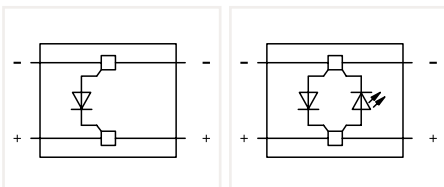

Diode module; with 1N4007 diode; 10 mm wide; gray

	Item No.	Pack. Unit
○ anode right	280-803/281-411	50

Diode module; with 1N4007 recovery diode; red LED; 10 mm wide; gray

○ 24 VDC	280-803/281-420	50
○ 48 VDC	280-803/281-421	50

Accessories; Through Terminal Blocks

Appropriate marking system:
WMB

2-conductor through terminal block;
0.08 ... 2.5 mm² / 28 ... 12 AWG*
Terminal block width: 5 mm / 0.197 inch

gray	280-901	100
------	---------	-----

End and intermediate plate; 2.5 mm thick

orange	280-309	100 (25)
gray	280-308	100 (25)

3-conductor through terminal block;
0.08 ... 2.5 mm² / 28 ... 12 AWG*
Terminal block width: 5 mm / 0.197 inch

gray	280-681	100
------	---------	-----

End and intermediate plate; 2.5 mm thick

orange	280-326	100 (25)
gray	280-324	100 (25)

4-conductor through terminal block;
0.08 ... 2.5 mm² / 28 ... 12 AWG*
Terminal block width: 5 mm / 0.197 inch

gray	280-833	100
------	---------	-----

End and intermediate plate; 2.5 mm thick

orange	280-315	100 (25)
gray	280-314	100 (25)

*12 AWG: THHN, THWN

Please observe the application notes:
Insulation stop, page 382
Comb-style jumper bar, page 383
Marking, from page 640

Approvals and corresponding ratings,
visit www.wago.com

Accessories; 280 Series

Appropriate marking systems:
WMB/WMB Inline/WFB

2-conductor through terminal block;
0.08 ... 2.5 mm² / 28 ... 12 AWG*
Terminal block width: 5 mm / 0.197 inch

gray	280-101	100
------	---------	-----

End and intermediate plate; 2.5 mm thick

orange	280-302	100 (25)
gray	280-301	100 (25)

Insulation stop; 0.08 ... 0.2 mm² "s" (0.14 mm² "f-st"); 5 pcs/strip

white	280-470	200 (25)
-------	---------	----------

Insulation stop; 0.25 ... 0.5 mm²; 5 pcs/strip

light gray	280-471	200 (25)
------------	---------	----------

Insulation stop; 0.75 ... 1 mm²; 5 pcs/strip

dark gray	280-472	200 (25)
-----------	---------	----------

Adjacent jumper; insulated; I_N = I_N terminal block

gray	280-402	200 (25)
------	---------	----------

Wire commoning chain; insulated; 50 connections; I_N 8 A

black	210-103	5
-------	---------	---

Wire commoning chain; insulated; 50 connections; I_N 8 A

blue	210-123	5
------	---------	---

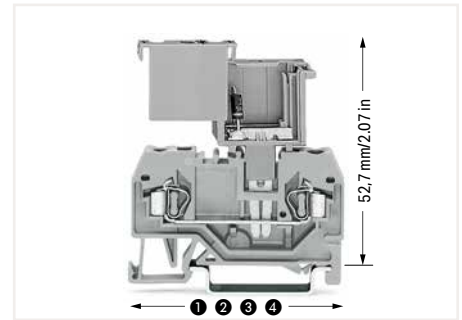

Lengths of through terminal blocks with a pluggable diode module:

- 1 53 mm / 2.09 inch for 280-901
- 2 64 mm / 2.52 inch for 280-681
- 3 75 mm / 2.95 inch for 280-833
- 4 45.5 mm / 1.67 inch for 280-101



Similar to push-in type jumpers, these diode modules are simply pushed into the current bar's contact slots of two adjacent through terminal blocks, providing the following advantages:

- Compatibility with all 280 Series Through Terminal Blocks
- Easy retrofits for existing systems
- Separation into functional and wiring levels
- Fast replacement of other functional units

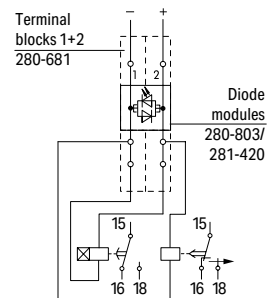
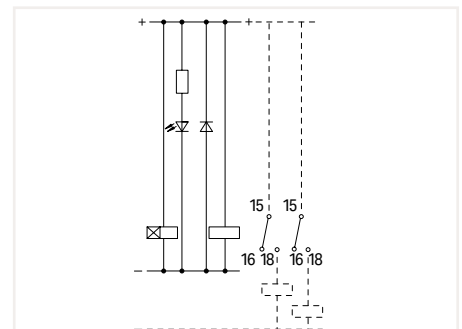

Free-wheeling diode and voltage check

Pluggable LED and Neon Indicator Module on Carrier Terminal Block 2.5 mm² 280 Series

Technical Data

Plug width: 5 mm / 0.197 inch

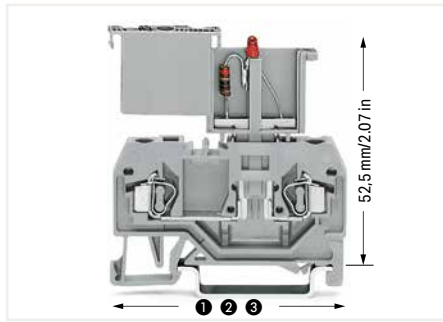

Lengths of carrier terminal blocks with a pluggable diode module:

- ❶ 53 mm / 2.09 inch for 280-916
- ❷ 64 mm / 2.52 inch for 280-610
- ❸ 75 mm / 2.95 inch for 280-816

LED module; with red LED; 5 mm wide; I_N 5.6 mA; I_F 25 mA; gray

	Item No.	Pack. Unit
○ 24 VDC	280-801/281-413	100
○ 48 VDC	280-801/281-414	100

LED module; with red LED; 5 mm wide; I_N 5.6 mA; I_F 25 mA; gray

○ 24 VAC/DC	280-801/281-415	100
○ 48 VAC/VDC	280-801/281-416	100

Neon indicator module; 5 mm wide; I_N 0.5 mA; gray

○ 120 VAC/VDC	280-801/281-418	100
○ 230 VAC/VDC	280-801/281-417	100

Carrier terminal blocks, see page 374

Circuit Diagrams

LED module

	24 VDC	280-801/281-413
	48 VDC	280-801/281-414

LED module

	24 VAC/DC	280-801/281-415
	48 VAC/VDC	280-801/281-416

Neon indicator module

	120 VAC/VDC	280-801/281-418
	230 VAC/VDC	280-801/281-417



The monitoring of control and operating current circuits with LED modules on rail-mount terminal blocks provides several advantages:

- No additional cost for assembly and wiring
- Separation into functional and wiring levels
- Modules can be replaced quickly by other types of modules
- Polarized switching direction
- Terminal blocks/modules provide high-density wiring in a width of just 5 mm



Carrier terminal blocks with component plugs, alternate comb-style jumper bars, 3-way, comb-style jumper bar

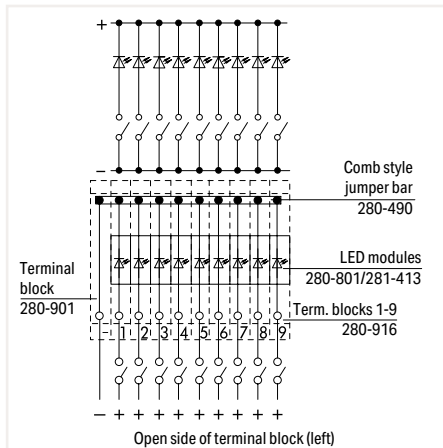

LED gate for collective fault indication – individual display

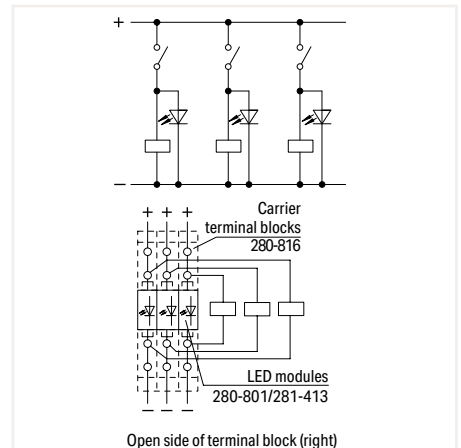

Voltage control assigned to current circuits

6

Pluggable LED and Neon Indicator Module on Through Terminal Block 2.5 mm² 280 Series

Technical Data

Plug width: 10 mm / 0.394 inch

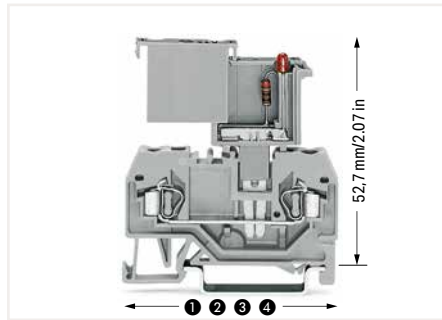

Lengths of through terminal blocks with a pluggable diode module:

- ❶ 53 mm / 2.09 inch for 280-901
- ❷ 64 mm / 2.52 inch for 280-681
- ❸ 75 mm / 2.95 inch for 280-833
- ❹ 45.5 mm / 1.67 inch for 280-101

LED module; with red LED; 10 mm wide; I_w 5.6 mA; I_F 25 mA; gray

	Item No.	Pack. Unit
○ 24 VDC	280-803/281-413	100
○ 48 VDC	280-803/281-414	100

LED module; with red LED; 10 mm wide; I_w 5.6 mA; I_F 25 mA; gray

○ 24 VAC/DC	280-803/281-415	100
○ 48 VAC/VDC	280-803/281-416	100

Neon indicator module; 10 mm wide; I_w 0.5 mA; gray

○ 120 VAC/VDC	280-803/281-418	100
○ 230 VAC/VDC	280-803/281-417	100

Through terminal blocks, see page 375

Circuit Diagrams

LED module

	24 VDC	280-803/281-413
	48 VDC	280-803/281-414

LED module

	24 VAC/DC	280-803/281-415
	48 VAC/VDC	280-803/281-416

Neon indicator module

	120 VAC/VDC	280-803/281-418
	230 VAC/VDC	280-803/281-417



Similar to push-in type jumpers, these LED and neon indicator modules are simply pushed into the current bar's contact slots of two adjacent through terminal blocks, providing the following advantages:

- Compatibility with all 280 Series Through Terminal Blocks
- Easy retrofits for existing systems
- Separation into functional and wiring levels
- Fast replacement of other functional units

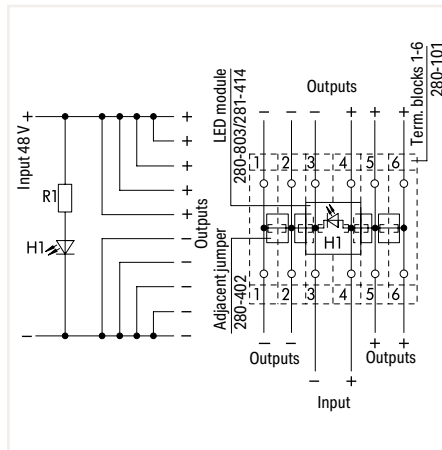

Multiple outputs with indicator lamp

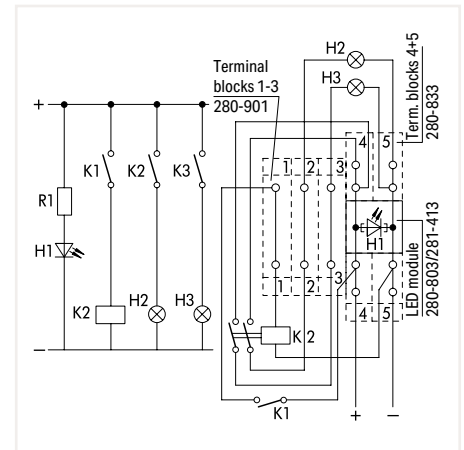

Control unit

CAGE CLAMP®

L-Type Test Plug Module for Testing 5 mm or 6 mm Wide Rail-Mount Terminal Blocks via Conductor Entry

249 Series

Technical Data	
0.08 ... 1.5 mm ²	28 ... 16 AWG
Test voltage: 630 V	Test current: 6 A
Module width: 5 mm / 0.197 inch	
This test plug is not suitable for Ex e applications.	



Technical Data	
0.08 ... 2.5 mm ²	28 ... 14 AWG
Test voltage: 630 V	Test current: 6 A
Module width: 6 mm / 0.236 inch	
This test plug is not suitable for Ex e applications.	



Snapping test plug and spacer modules together to assemble a multipole test plug module (max. 10 poles).

L-type test plug module; with spring-loaded contact pin; center module; snaps together
Module width: 5 mm

Color	Item No.	Pack. Unit
○ gray	249-141	100 (25)

L-type test plug module; with spring-loaded contact pin; center module; snaps together
Module width: 6 mm

Color	Item No.	Pack. Unit
○ gray	249-144	100 (25)

L-type end test plug module; with rigid contact pin; end module; snaps together
Module width: 5 mm

○ gray	249-142	100 (25)
--------	---------	----------

L-type end test plug module; with rigid contact pin; end module; snaps together
Module width: 6 mm

○ gray	249-145	100 (25)
--------	---------	----------

L-type spacer module; snaps together; bridges wired terminal blocks
Module width: 5 mm

○ gray	249-143	100 (25)
--------	---------	----------

L-type spacer module; snaps together; bridges wired terminal blocks
Module width: 6 mm

○ gray	249-146	100 (25)
--------	---------	----------

Accessories; for L-type test plug modules

Appropriate marking systems: WMB/WMB Inline/Mini-WSB/Mini-WSB Inline

WMB marking card; white; 10 strips with 10 markers/card; stretchable 5 ... 5.2 mm

plain	793-5501	5
-------	----------	---



Mini-WSB marking card; 10 strips with 10 markers/card; 5 mm wide markers

plain	248-501	5
-------	---------	---

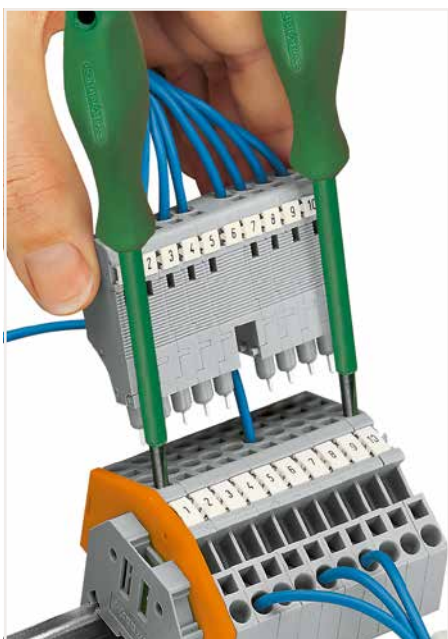

For easily testing terminal block assemblies, WAGO's L-type test plug modules with CAGE CLAMP® may be used on unwired terminal blocks. For testing, the module is assembled with spring-loaded pins in the center positions and rigid pin modules at the ends. The terminal blocks corresponding to the end position modules are opened using operating tools (as shown) – these rigid pins are then held in place by the CAGE CLAMP®. The intermediate pins are spring-loaded and make contact with the current bars of the unwired clamping units. Clamping units needing to remain wired may be skipped by assembling a spacer in the test plug module.

Notice:
Mating direction must be observed (see picture).

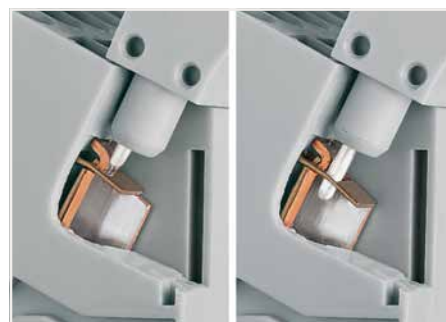

A = Center module with a spring-loaded contact pin
B = End module with a rigid contact pin



CAGE CLAMP® connection
0.08 ... 1.5 mm²; 5 mm wide module
0.08 ... 2.5 mm²; 6 mm wide module

Power must be switched off when installing the test plug adapter. The safety guidelines for working on live installations must be observed.

B-Type Test Plug Module for Testing 5 mm or 6 mm Wide Rail-Mount Terminal Blocks via Jumper Contact Slot in Current Bar 249 Series

Technical Data	
0.08 ... 1.5 mm ²	28 ... 16 AWG
Test voltage: 630 V	Test current: 10 A
Module width: 5 mm / 0.197 inch	
This test plug is not suitable for Ex e applications.	



Technical Data	
0.08 ... 2.5 mm ²	28 ... 14 AWG
Test voltage: 630 V	Test current: 10 A
Module width: 6 mm / 0.236 inch	
This test plug is not suitable for Ex e applications.	



Snapping test plug and spacer modules together to assemble a multipole test plug module (max. 10 poles).

B-type test plug module; snaps together Module width: 5 mm		
Color	Item No.	Pack. Unit
○ gray	249-106	100 (25)

B-type test plug module; snaps together Module width: 6 mm		
Color	Item No.	Pack. Unit
○ gray	249-147	100 (25)

B-type spacer module; snaps together; bridges commoned terminal blocks, Module width: 5 mm		
Color	Item No.	Pack. Unit
○ gray	249-107	100 (25)

B-type spacer module; snaps together; bridges commoned terminal blocks, Module width: 6 mm		
Color	Item No.	Pack. Unit
○ gray	249-148	100 (25)

Accessories; for B-type test plug modules
Appropriate marking systems: WMB/WMB Inline/Mini-WSB/Mini-WSB Inline

WMB Inline, plain; 1,500 WMB markers (5 mm)/reel; 5 ... 5.2 mm stretchable			
Color	Item No.	Quantity	Unit
white	2009-115	1	Reel

Mini-WSB Inline, plain; 1,700 Mini-WSB markers (5 mm wide) per reel; stretchable 5 ... 5.2 mm			
Color	Item No.	Quantity	Unit
white	2009-145	1	Reel

WMB marking card; white; 10 strips with 10 markers/card; stretchable 5 ... 5.2 mm		
Color	Item No.	Quantity
plain	793-5501	5

Mini-WSB marking card; 10 strips with 10 markers/card; 5 mm wide markers		
Color	Item No.	Quantity
plain	248-501	5

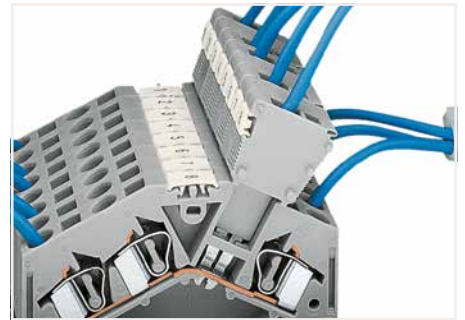

B-type test plugs are directly plugged into the jumper contact slot of the current bar.

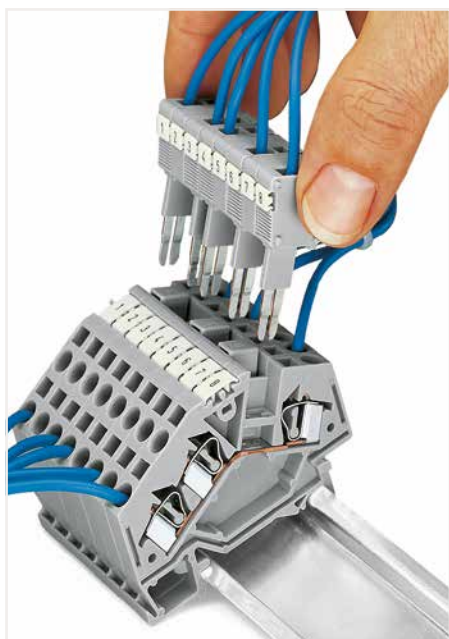

For testing individual circuits, offers a single-pole test plug accessory with CAGE CLAMP® up to 2.5 mm² (14 AWG) for direct contact with the current bar of a terminal block, or 1-pole test plug adapters for 4 mm Ø test plugs.

For serial testing on terminal block assemblies, has developed special multipole (max. 10-pole) modular test plug modules. WAGO's B-type test plug modules with CAGE CLAMP® connection are ideal for testing completely wired terminal blocks – even when using adjacent jumpers. For this testing type, the module assembly exactly matches the terminal block assembly. The test plug modules make direct contact to the jumper contact slots of the terminal blocks to be tested.

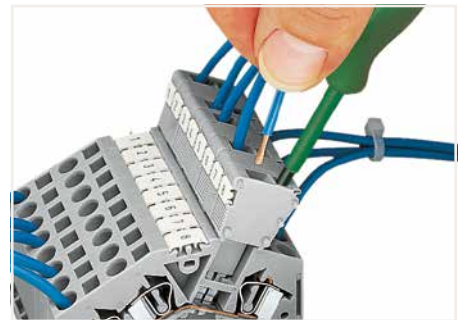

CAGE CLAMP® connection
0.08 ... 1.5 mm²; 5 mm wide module
0.08 ... 2.5 mm²; 6 mm wide module

Power must be switched off when installing the test plug adapter. The safety guidelines for working on live installations must be observed.

Test Plug Module for Testing 5 mm or 6 mm Wide Rail-Mount Terminal Blocks via Jumper Contact Slot in Current Bar

Technical Data	
Test voltage: 400 V	Test current: 6 A
Module width: 5 mm / 0.197 inch	
This test plug is not suitable for Ex e applications.	



Technical Data	
Test voltage: 400 V	Test current: 6 A
Module width: 6 mm / 0.236 inch	
This test plug is not suitable for Ex e applications.	

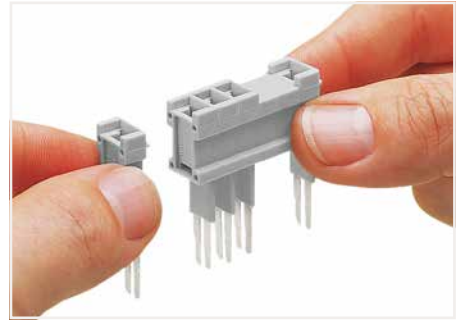

Snapping test plug and spacer modules together to assemble a multipole test plug module.

Test plug module; snaps together Module width: 5 mm		
Color	Item No.	Pack. Unit
○ gray	280-418	100 (25)

Test plug module; snaps together Module width: 6 mm		
Color	Item No.	Pack. Unit
○ gray	281-418	100 (25)

Spacer module; snaps together; bridges terminal blocks Module width: 5 mm		
Color	Item No.	Pack. Unit
○ gray	280-419	100 (25)

Spacer module; snaps together; bridges terminal blocks Module width: 6 mm		
Color	Item No.	Pack. Unit
○ gray	281-419	100 (25)

Accessories; for test plug modules

Test plug; with 500 mm cable; 2 mm Ø; max. 42 V		
red	210-136	50

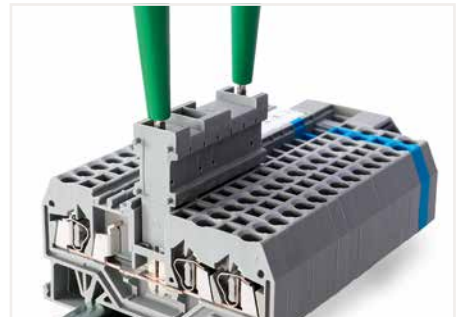

The test plug modules are directly plugged into the jumper contact slot of the current bar.

6

B-Type Test Plug Module for Testing 8 mm or 10 mm Wide Rail-Mount Terminal Blocks via Jumper Contact Slot in Current Bar 709 Series

Technical Data	
0.2 ... 6 mm ²	24 ... 10 AWG
Test voltage: 800 V	Test current: 32 A
Module width: 8 mm / 0.315 inch	
This test plug is not suitable for Ex e applications.	



Technical Data	
Module width: 2 mm / 0.079 inch	
This intermediate plate is not suitable for Ex e applications.	

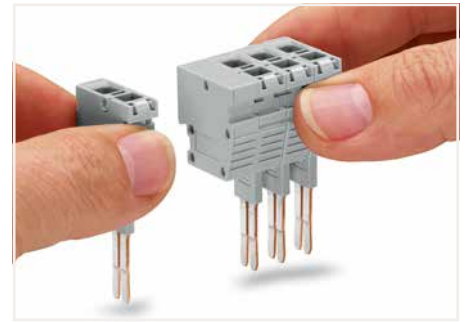

Snapping test plug and spacer modules together to assemble a multi-pole test plug module (max. 10 poles) for 8 mm terminal block width.

B-type test plug module; snaps together Module width: 8 mm		
Color	Item No.	Pack. Unit
○ gray	709-310	100 (25)

B-type spacer plate; snaps together; snaps on B-type test plug modules (709-310) and B-type spacer modules (709-311) Module width: 2 mm		
Color	Item No.	Pack. Unit
○ gray	709-312	100 (25)

B-type spacer module; snaps together; bridges commoned terminal blocks, Module width: 8 mm		
Color	Item No.	Pack. Unit
○ gray	709-311	100 (25)

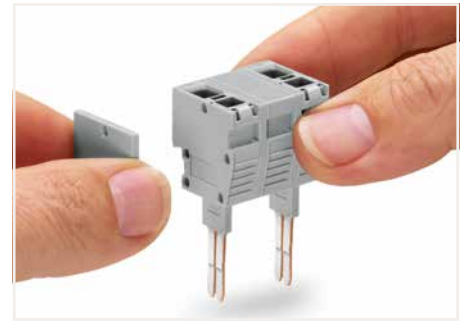

Snapping test plug and spacer modules (each with a spacer plate) together to assemble a multi-pole test plug module (max. 10 poles) for 10 mm terminal block width.

Accessories; item-specific			
Strain relief plate; gray; for 8 mm wide terminal blocks			
	2-pole	709-322	100 (25)
	4-pole	709-324	100 (25)
	6-pole	709-326	100 (25)

Accessories; item-specific			
Strain relief plate; gray; for 10 mm wide terminal blocks			
	2-pole	709-332	100 (25)
	4-pole	709-334	100 (25)
	6-pole	709-336	100 (25)



For testing individual circuits, offers a single-pole test plug accessory with CAGE CLAMP® up to 2.5 mm² (14 AWG) for direct contact with the current bar of a terminal block, or 1-pole test plug adapters for 4 mm Ø test plugs.

For serial testing on terminal block assemblies, has developed special multipole (max. 10-pole) modular test plug modules. WAGO's B-type test plug modules with CAGE CLAMP® connection are ideal for testing completely wired terminal blocks – even when using adjacent jumpers. For this testing type, the module assembly exactly matches the terminal block assembly. The test plug modules make direct contact to the jumper contact slots of the terminal blocks to be tested.

Power must be switched off when installing the test plug adapter. The safety guidelines for working on live installations must be observed.



The test plug modules are directly plugged into the jumper contact slot of the current bar (picture shows 284 Series).

Conductor Insulation Stop for Conductors 0.08 ... 1.5 mm² / 28 ... 16 AWG

Technical Data		
Terminal block width: 4 mm / 0.157 inch		



Technical Data		
Terminal block width: 5 mm / 0.197 inch		



Technical Data		
Terminal block width: 6 mm / 0.236 inch		



Insulation stop; 0.08 ... 0.2 mm ² "s" (0.14 mm ² "f-st"); 5 pcs/strip		
Color	Item No.	Pack. Unit
○ white	279-470	200 (25)

Insulation stop; 0.08 ... 0.2 mm ² "s" (0.14 mm ² "f-st"); 5 pcs/strip		
Color	Item No.	Pack. Unit
○ white	280-470	200 (25)

Insulation stop; 0.08 ... 0.2 mm ² "s" (0.14 mm ² "f-st"); 5 pcs/strip		
Color	Item No.	Pack. Unit
○ white	281-470	200 (25)

Insulation stop; 0.25 mm ² ; 5 pcs/strip		
Color	Item No.	Pack. Unit
● dark gray	279-471	200 (25)

Insulation stop; 0.25 ... 0.5 mm ² ; 5 pcs/strip		
Color	Item No.	Pack. Unit
○ light gray	280-471	200 (25)

Insulation stop; 0.25 ... 0.5 mm ² ; 5 pcs/strip		
Color	Item No.	Pack. Unit
○ light gray	281-471	200 (25)

Insulation stop; 0.75 ... 1 mm ² ; 5 pcs/strip		
Color	Item No.	Pack. Unit
● dark gray	280-472	200 (25)

Insulation stop; 0.75 ... 1.5 mm ² ; 5 pcs/strip		
Color	Item No.	Pack. Unit
● dark gray	281-472	200 (25)

6

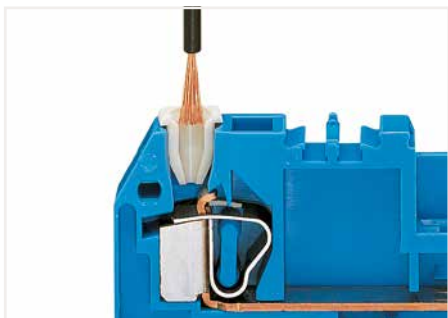

Insert stripped, untwisted conductor into insulation stop.



The problem: Wiring programmable logic controllers and microprocessor-operated control circuits often relies on very small, fine-stranded conductors. These conductors are highly flexible and deform when pushed against the conductor stop in terminal blocks. As a result, the conductor insulation – not the copper conductor – may be clamped, causing intermittent contact or no contact at all. Common to all terminal block types currently offered, this problem creates unnecessary downtime for troubleshooting.

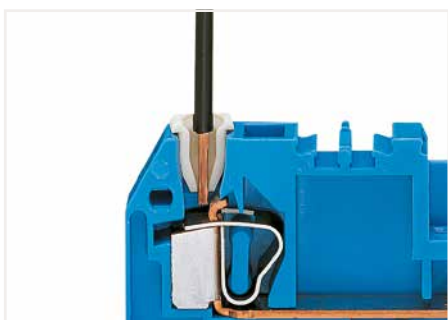

The conductor is bundled.

The solution: An insulation stop for rail-mount terminal blocks. Insulation stops automatically bundle the cores of fine-stranded conductors when inserted into the clamping unit, preventing splaying. This also limits the conductor entry to a defined cross sectional area – ensuring the actual conductor, not the insulation, will enter the clamping unit

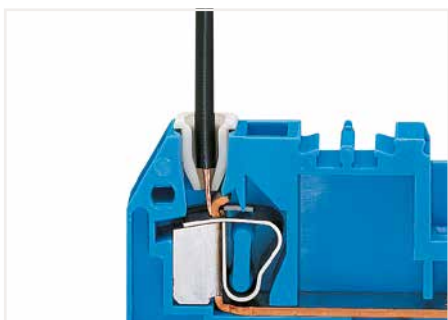

The conductor insulation is prevented from being pushed into the clamping unit by the positive stop.

Insulation stops are available as dividable 5-pole strips for 279, 280/780/870/880 and 281/781 Series Rail-Mount Terminal Blocks. Insulation stop usage will not affect the conductor strip lengths for the aforementioned rail-mount terminal blocks.

Comb-Style Jumper Bar and Alternate Comb-Style Jumper Bar Operating Tool



Comb-style jumper bar; insulated; $I_N = I_N$ of terminal block; for 279 Series

	Item No.	Pack. Unit
○ 2-way	279-482	200 (25)
○ 3-way	279-483	200 (25)
○ 10-way	279-490	50 (25)

Comb-style jumper bar; insulated; $I_N = I_N$ of terminal block; for 280/769/780/880 Series

	Item No.	Pack. Unit
○ 2-way	280-482	200 (25)
○ 3-way	280-483	200 (25)
○ 10-way	280-490	50 (25)

Comb-style jumper bar; insulated; $I_N = I_N$ of terminal block; for 281/781 Series

	Item No.	Pack. Unit
○ 2-way	281-482	100 (25)
○ 3-way	281-483	100 (25)
○ 5-way	281-485	100 (25)
○ 10-way	281-490	50 (25)

Alternate comb-style jumper bar; insulated; $I_N = I_N$ of terminal block

○ 2-way	279-492	200 (25)
---------	---------	----------

Alternate comb-style jumper bar; insulated; $I_N = I_N$ of terminal block

○ 2-way	280-492	200 (25)
---------	---------	----------

Alternate comb-style jumper bar; insulated; $I_N = I_N$ of terminal block

○ 2-way	281-492	100 (25)
---------	---------	----------

Operating tool; insulated

2-way	279-432	1
3-way	279-433	1
10-way	279-440	1

Operating tool; insulated

2-way	280-432	1
3-way	280-433	1
10-way	280-440	1

Operating tool; insulated

2-way	280-432	1
3-way	280-433	1
5-way	281-440	1

6

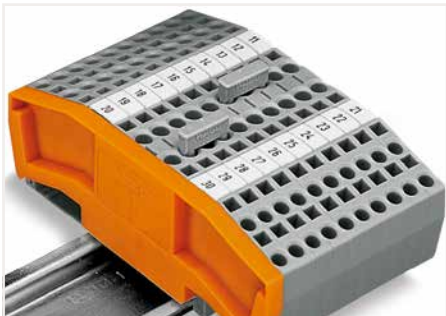

Commoning using comb-style jumper bars. Push comb-style jumper bars down until fully inserted.



4-conductor through terminal blocks, angled type – formation of groups with 3-way, comb-style jumper bars

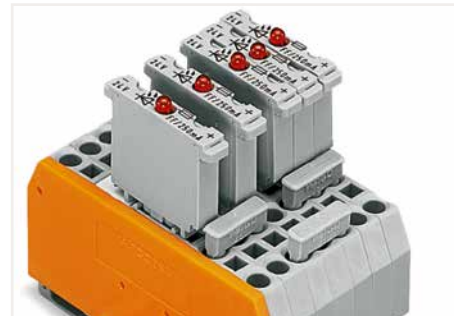

Carrier terminal blocks with component plugs, alternate comb-style jumper bars, 3-way, comb-style jumper bar

Staggered Jumper

Technical Data

400 V/6 kV/3



- ❶ Suitable for Ex e II applications
Rated voltage (max.): 275 V
23 A, for 2-conductor terminal blocks
22 A, for 3-conductor terminal blocks
20 A, for 4-conductor terminal blocks
(see Section 15)
- ❷ Suitable for Ex e II applications
Rated voltage (max.): 275 V; 26 A
(see Section 15)

Staggered jumper; insulated; 5 mm wide; I_n 24 A

	Item No.	Pack. Unit
<input type="radio"/> 1 to 2	780-452 ❶	100 (25)
<input type="radio"/> 1 to 3	780-453 ❶	100 (25)
<input type="radio"/> 1 to 4	780-454 ❶	100 (25)
<input type="radio"/> 1 to 5	780-455 ❶	50 (25)
<input type="radio"/> 1 to 6	780-456 ❶	50 (25)
<input type="radio"/> 1 to 7	780-457 ❶	50 (25)
<input type="radio"/> 1 to 8	780-458 ❶	50 (25)

Staggered jumper; insulated; 6 mm wide; I_n 32 A

<input type="radio"/> 1 to 2	781-452 ❷	100 (25)
<input type="radio"/> 1 to 3	781-453 ❷	100 (25)
<input type="radio"/> 1 to 4	781-454 ❷	100 (25)
<input type="radio"/> 1 to 5	781-455 ❷	50 (25)
<input type="radio"/> 1 to 6	781-456 ❷	50 (25)

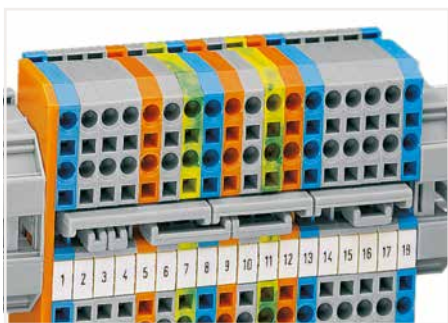

Staggered jumpers for sophisticated circuit requirements
– push jumpers down until fully inserted.

Push-In Type Wire Jumper

Technical Data

800 V/8 kV/3

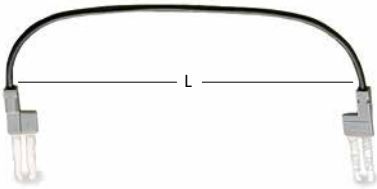
I_N 9 A

Push-in type wire jumper; insulated; 0.75 mm² conductor cross section

	Item No.	Pack. Unit
L = 60 mm	249-125	10

Push-in type wire jumper; insulated; 0.75 mm² conductor cross section

L = 110 mm	249-126	10
------------	---------	----

Push-in type wire jumper; insulated; 0.75 mm² conductor cross section

L = 250 mm	249-127	10
------------	---------	----

Terminal Blocks Series	Wire Jumpers Item No.	"n"
279 (1.5 mm ² /16 AWG)	249-125	13
	249-126	25
	249-127	60
280, 775, 780 (2.5 mm ² /14 AWG) 769, 880 (4 mm ² /12 AWG)	249-125	10
	249-126	20
	249-127	48
281, 781, 776, 777 (4 mm ² /12 AWG)	249-125	9
	249-126	17
	249-127	40

"n" = number of 279, 280/769/780/880 and 281/781 Series Rail-Mount Terminal Blocks that can be skipped with a wire jumper.

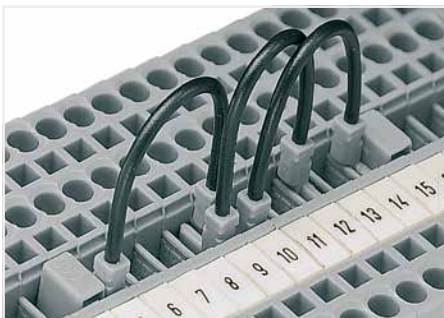

The 280/775/780 and 281/776/777/781 Series Terminal Blocks accept two wire jumpers, allowing the use of commoning chains. Furthermore, the 280/769/775/780/880 and 281/776/777/781 Series allow both wire jumper and adjacent jumper to be simultaneously plugged into a same terminal block.

Push-in type wire jumper:

When installing machines or control systems, it is often necessary to make an additional connection between two terminal blocks that are not next to each other on the rail. In such cases, WAGO's touch-proof, push-in type wire jumpers are the ideal solution.





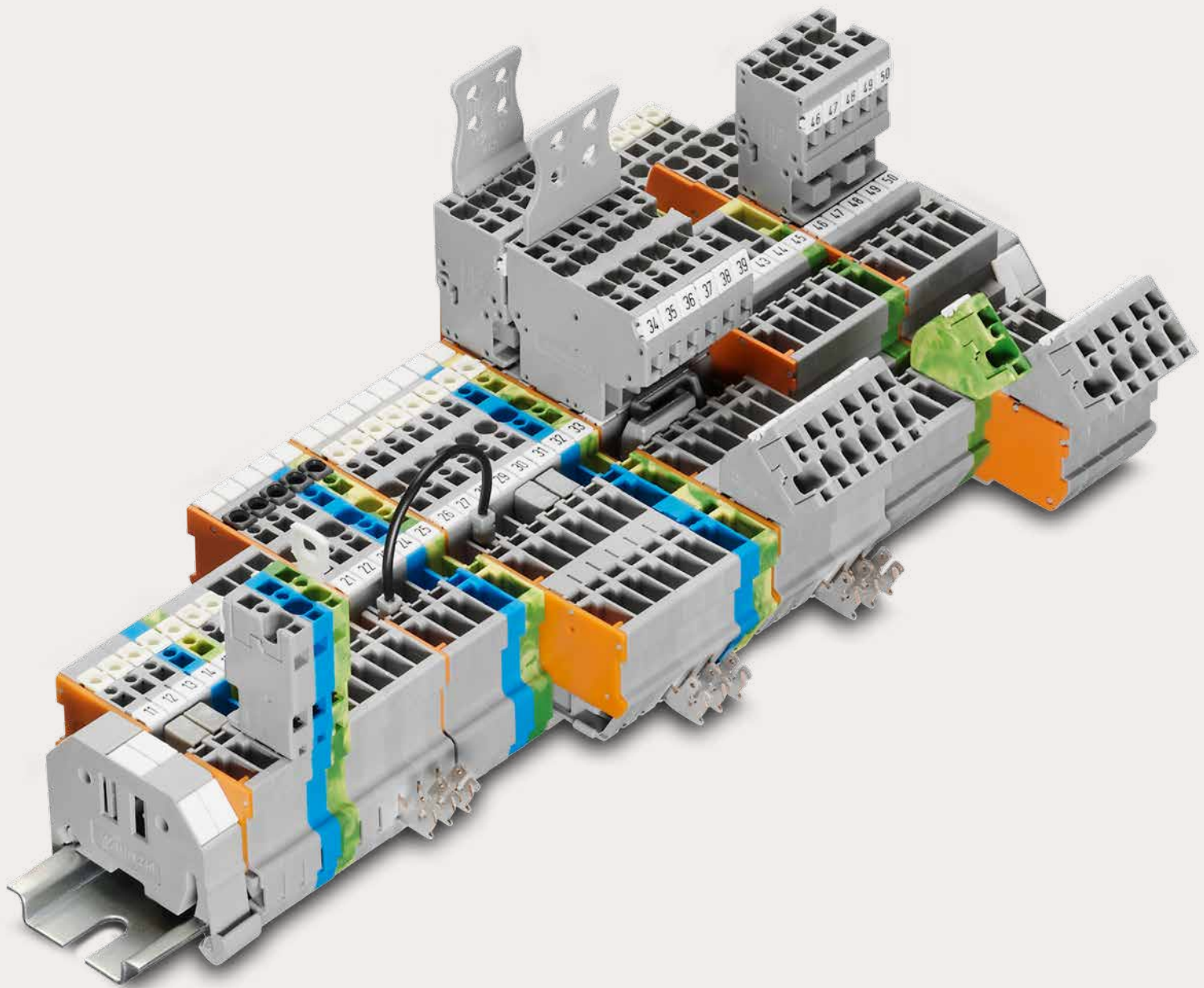



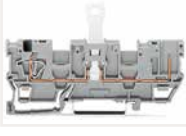

This jumper is compatible with the following rail-mount terminal blocks:

- 279 Series (1.5 mm²/16 AWG),
 - 280/775/780 Series (2.5 mm²/14 AWG)
 - 281/769/776/777/781 and 880 Series (4 mm²/12 AWG)
- They are available in three conductor lengths (60, 110 and 250 mm), allowing up to 60 terminal blocks to be commoned depending on their width (see table on the right).

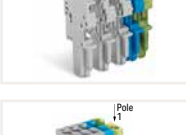

WAGO Rail-Mount Terminal Blocks with a Pluggable Connector X-COM[®]-SYSTEM

WAGO Rail-Mount Terminal Blocks with a Pluggable Connector X-COM®-SYSTEM Front-Entry Wiring

			Page
	Carrier Terminal Blocks 0.08 ... 4 mm ² (28 ... 12 AWG)	769 Series	394
	Carrier Terminal Blocks; with Three Jumper Positions 0.08 ... 4 mm ² (28 ... 12 AWG)	769 Series	404
	Disconnect Carrier Terminal Blocks; with Two Jumper Positions 0.08 ... 4 mm ² (28 ... 12 AWG)	769 Series	406
	Diode and LED Carrier Terminal Blocks 0.08 ... 4 mm ² (28 ... 12 AWG)	769 Series	408
	Carrier Terminal Blocks for a Pluggable Module 0.08 ... 4 mm ² (28 ... 12 AWG)	769 Series	416
	Double-Deck Carrier Terminal Blocks 0.08 ... 2.5 (4 "f-st") mm ² (28 ... 12 AWG)	870 Series	424
	Male Connectors; with CAGE CLAMP® Connection 0.08 ... 4 mm ² (28 ... 12 AWG)	769 Series	434
	Male Headers; with Solder Pins 0.08 ... 4 mm ² (28 ... 12 AWG)	769 Series	438
	Female Plugs; with/without Lateral Locking Levers 0.08 ... 4 mm ² (28 ... 12 AWG)	769 Series	444
	Female Plugs for Self-Assembly 0.08 ... 4 mm ² (28 ... 12 AWG)	769 Series	448
	Pre-Assembled Female Plugs 0.08 ... 4 mm ² (28 ... 12 AWG)	769 Series	450
	Strain Relief Housings	769 Series	452

COM-bining Connectors and Rail-Mount Terminal Blocks X-COM®-SYSTEM

The X-COM-SYSTEM® is the perfect solution for switchgear and control applications.

X-COM® is designed for a **rated current up to 16/32 A at U_N 500 V and 4 mm² (12 AWG) rated cross section (up to 600 V, 10 A, and 12 AWG UL)**. This offers an alternative to heavy-duty rectangular and circular connectors used in power wiring applications where electrical compliance is more important than a high degree of protection.

X-COM® conveniently enables the use of pre-assembled connector systems and offers the following advantages:

- During manufacturing: Pre-wired subassemblies can be tested before installation.
- During assembly: Pre-assembled pluggable cable harnesses help solve time and space issues on site. Connector systems with protection against mismatching can be handled by installers of all skill levels.
- During maintenance: Subassemblies can be replaced quickly and without errors.

The X-COM®-SYSTEM consists of rail-mount carrier terminal blocks, male connectors and female plugs with different mounting systems, as well as male headers with solder pins. Pin spacing is generally 5 mm (0.197 inch).

Protection Against Mismatching and Accidental Contact

The WAGO-X-COM®-SYSTEM is **fully protected against accidental contact – even when plugs are disconnected**. This dramatically simplifies the planning of power distribution.

Furthermore, the whole system is **100% protected against mismatching**. Its coding, without the loss of any poles, prevents mismatching of male connectors and female plugs having the same number of poles.

Carrier Terminal Blocks

Carrier terminal blocks are available as through terminal blocks, double-deck terminal blocks and ground conductor terminal blocks with automatic contact to the DIN-rail. Carrier terminal blocks with specialty functions are available in disconnect, diode and LED versions. Carrier terminal blocks equipped with an additional socket can accommodate a wide range of pluggable electronic modules (e.g., relays, optocouplers, signal conditioners).

Depending on the type of terminal block, the carrier terminal blocks are equipped with one to three jumper positions for commoning signals via insulated push-in type jumpers.

Applications

X-COM®-SYSTEM connects to:

- Frequency converters
- Thyristor actuators
- Soft start motor controllers
- Motors
- Phase filters
- Power subassemblies
- Power supply units
- Uninterruptible power supply (UPS)
- "Panel-to-door" wiring
- Pluggable high-current, feed-through connections
- Flying leads

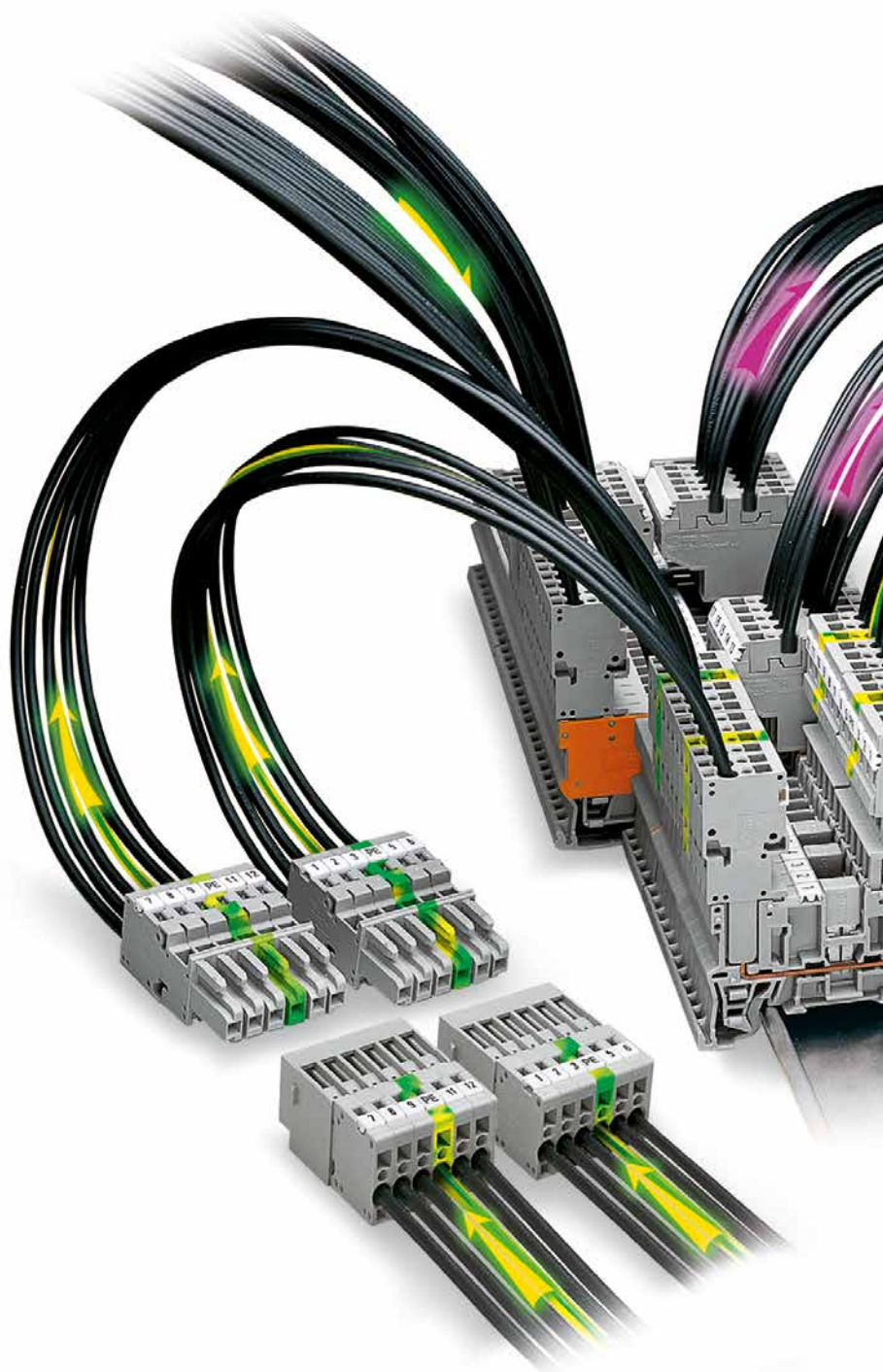

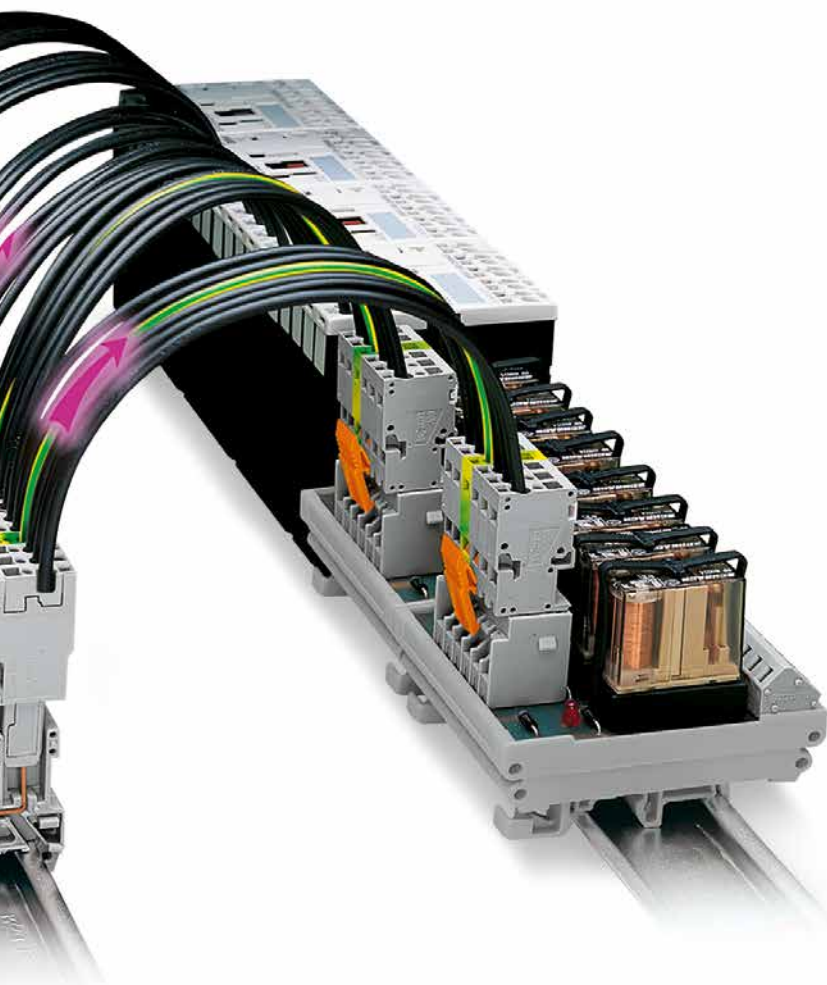

Female Plugs

The mating half of the carrier terminal blocks consists of modular female plugs (1- to 15-pole, 1-/2-conductor, straight/angled). Angled female plugs combined with double-deck terminal blocks offer high-density wiring and reduce overall terminal block height. A jumper slot simplifies potential distribution.

This makes commoning supply lines particularly easy as the power supply of downstream subassemblies is maintained even after female plugs have been removed.

1-Pole Female Plugs

Special 1-pole female plugs can carry the full rated current of the terminal blocks for many applications:

- as test plug adapters
- as connectors for motor lead tests
- for all types of patchboard applications
- for the creation of multipole prototypes
- for phase selection of 230 V loads in a three-phase network without interfering with the wiring
- for single-pole power supply in commercial or recreational vehicles. The grounding of all electrical components is connected through the chassis.

Male Connectors

Male connectors are available with snap-in mounting feet for panel mounting, with mounting flanges for feedthrough applications or without mounting elements for flying leads. Strain relief plates are available as accessories.

Subassemblies on printed circuit boards can be integrated into the system wiring using male headers with solder pins. As a result, parts can be exchanged quickly without wiring errors.

Degree of Protection

Mated: IP20

Unmated: IP20

Temperature range:

-35 ... +100 °C

Carrier Terminal Blocks and Female Plugs X-COM®-SYSTEM

769 Series

Description and Installation



Snap individual carrier terminal blocks onto the DIN-rail and slide together.



Open the assembly by laterally sliding a block via operating tool and remove terminal block via release lever.

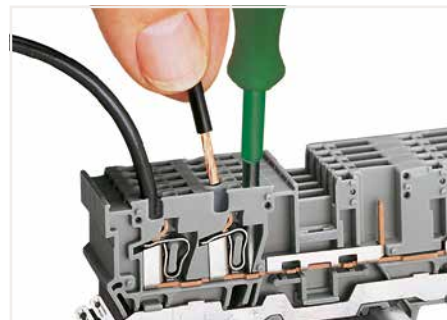

Carrier terminal block: Insert/remove conductor via operating tool (3.5 x 0.5 mm blade).



Coding a female plug by removing coding finger(s) via cutting tool. Do not remove the first and last coding fingers or use an additional locking lever.

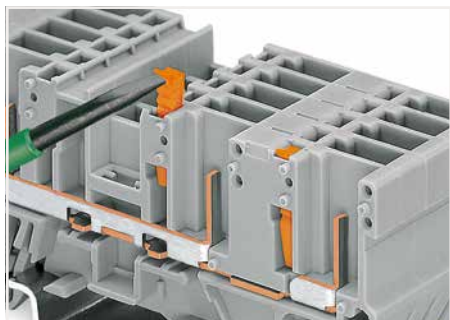

Snap coding pin in proper direction on carrier terminal block.
Shown: Coding pin removal from carrier terminal block.

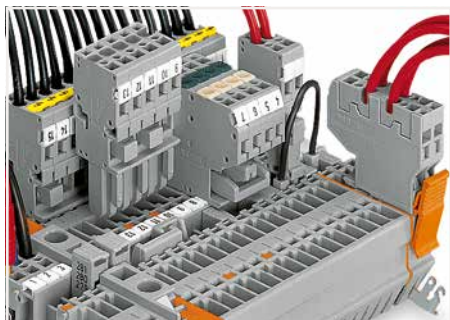
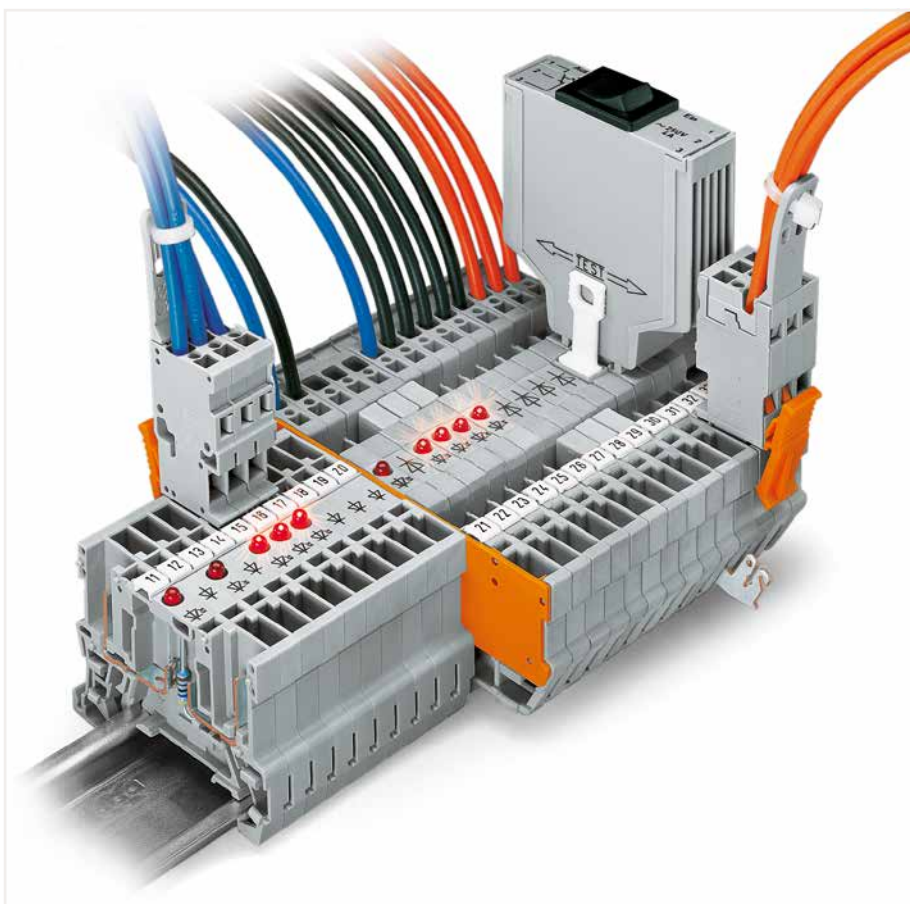

Commoning with adjacent or staggered jumpers – push jumpers down until fully inserted.

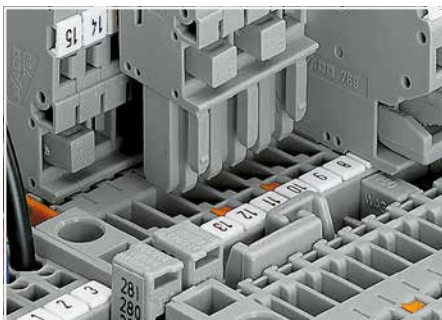

Commoning carrier terminal blocks via staggered jumpers.

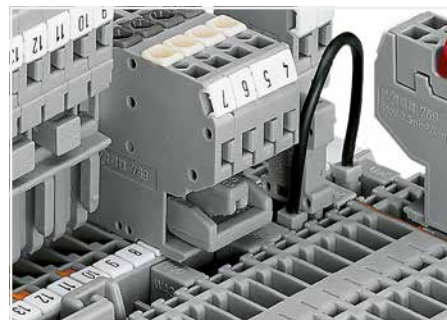

Commoning a 2-conductor female plug via staggered jumper and carrier terminal blocks via adjacent jumpers.



CAGE CLAMP® terminates the following copper conductors:
solid "s"



stranded "st"



fine-stranded "f-st", also with tinned single strands

With ferruled conductors, it is necessary to use a terminal block one size smaller than the conductor's nominal cross section.



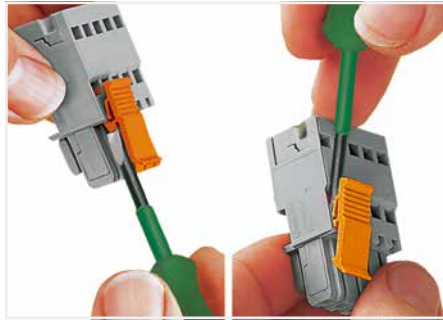
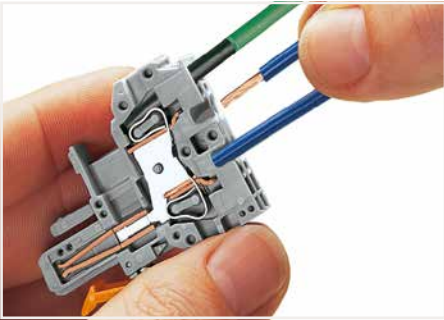

CAGE CLAMP® connection
 Female plug: Inserting/removing a conductor via operating tool.
 Operation 90° to conductor is also possible.
 With ferruled conductors, it is necessary to use a terminal block one size smaller than the conductor's nominal cross section.

Locking/releasing a lever.

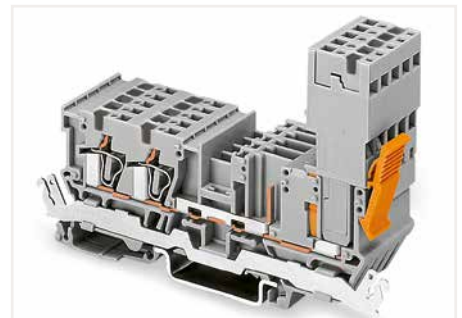
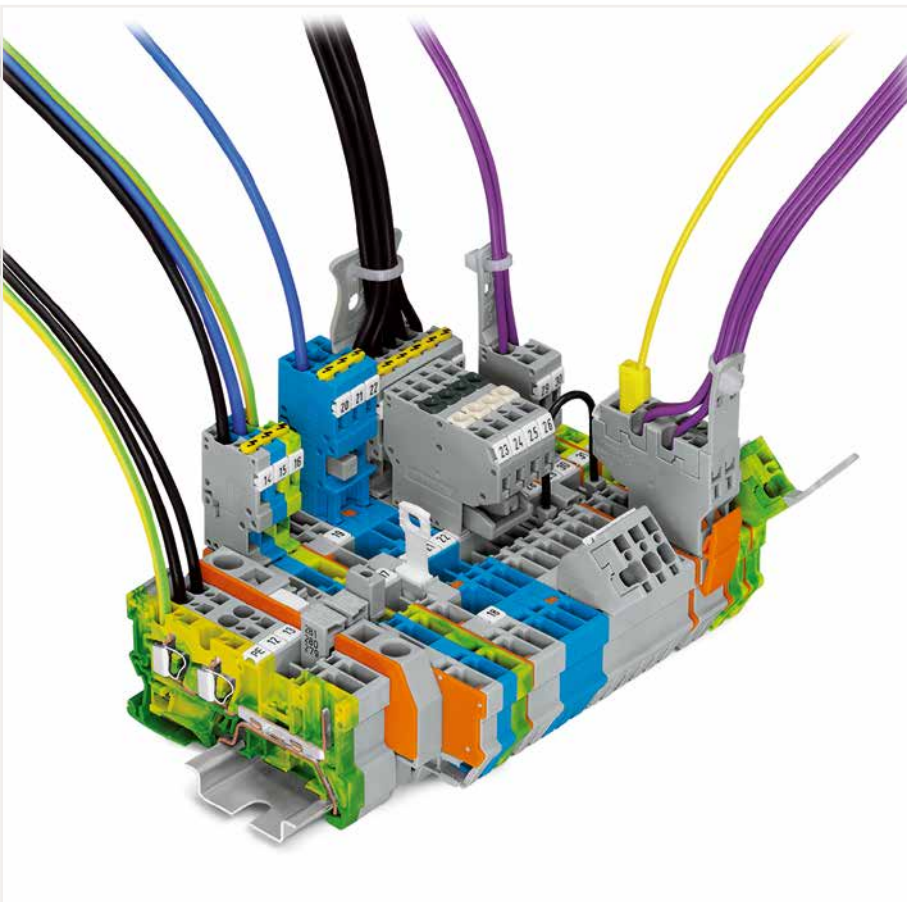

Female plug secured with locking lever on the terminal block side.



Removing a female plug via conductor bundle provided with strain relief plate.

Note: Female plugs used according to the regulations must not be connected/disconnected when live or under load.

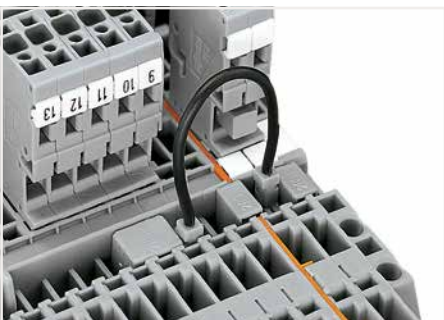

Commoning carrier terminal blocks via push-in type wire jumpers or adjacent jumpers – even over an intermediate plate.

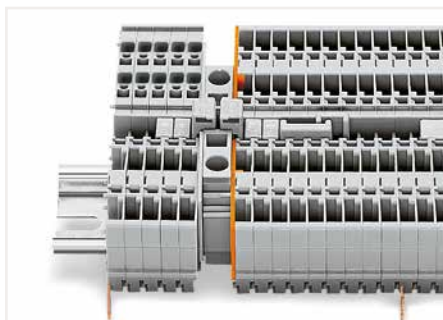

Commoning "supply terminal blocks" (up to 10 mm²/8 AWG) with carrier terminal blocks via step-down jumpers.



Commoning a 1-conductor female plug via miniature adjacent jumpers.



fine-stranded, tip-bonded



fine-stranded, with ferrule (gastight crimped)



fine-stranded, with pin terminal (gastight crimped)

Carrier Terminal Blocks, Female Plugs and Male Connectors X-COM®-SYSTEM

769 Series

Product Range Overview



1-conductor/1-pin carrier terminal block
1-connector female plug; straight*
*1-conductor angled female plug is also possible!

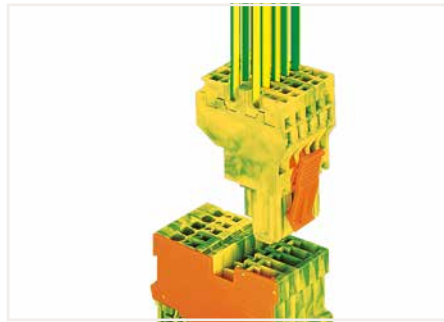

1-conductor/1-pin ground carrier terminal block
2-conductor female plug; green-yellow

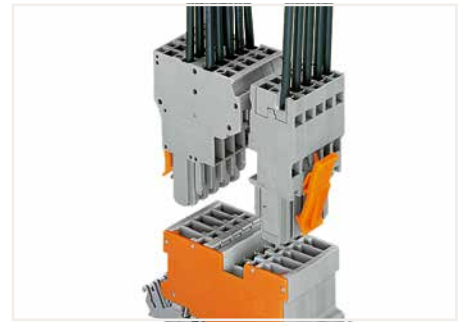

2-pin carrier terminal block; with shield contact
2-conductor female plug
1-connector female plug; straight*
*1-conductor angled female plug is also possible!

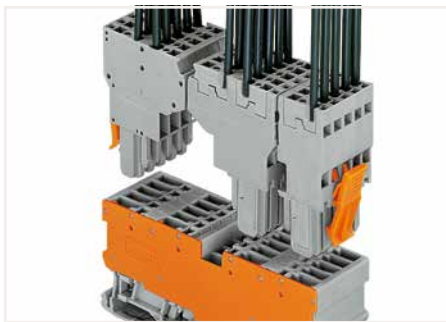

4-pin carrier terminal block
2-conductor female plug
1-connector female plug; straight

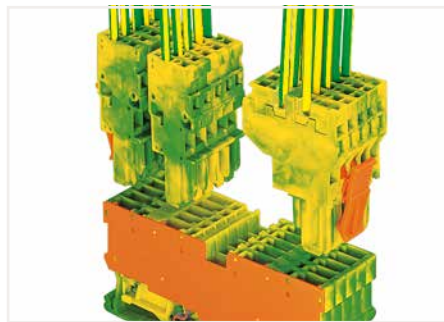

4-pin ground carrier terminal block
1-connector female plug; straight
2-conductor female plug

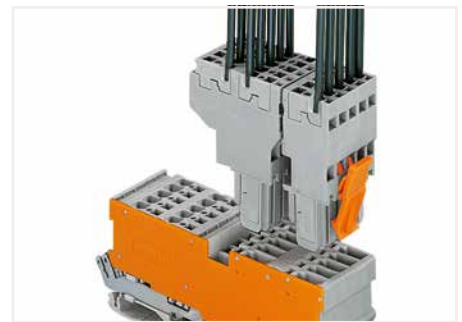

2-conductor/2-pin carrier terminal block; with shield contact
2-conductor female plug
1-connector female plug; straight



1-conductor/1-pin disconnect carrier terminal block
1-connector female plug; straight*
*1-conductor angled female plug is also possible!



2-pin diode carrier block
1-connector female plug; straight*
*1-conductor angled female plug is also possible!



2-pin LED carrier block
1-connector female plug; straight*
*1-conductor angled female plug is also possible!



2-pin disconnect carrier terminal block; with two jumper positions
1-connector female plug; straight*
*1-conductor angled female plug is also possible!



1-conductor/1-pin diode carrier terminal block; with two jumper positions
2-conductor female plug



2-pin LED carrier terminal block; with two jumper positions
2-conductor female plug
1-connector female plug; straight

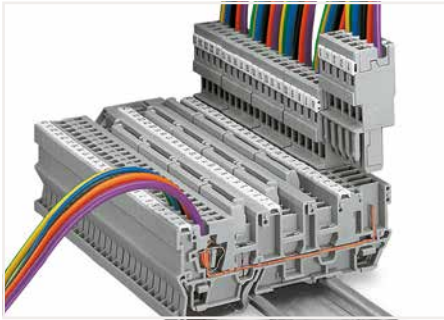

1-conductor/1-pin carrier terminal block; with three jumper positions
1-conductor female plug; straight*
*1-conductor angled female plug is also possible!



Male connector; with CAGE CLAMP® connection
1-conductor female plug; straight

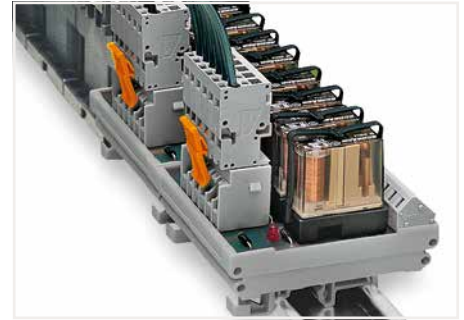

Male header; with straight solder pins and 1-conductor female plug (picture shows a relay module)



1-conductor/1-pin carrier terminal block; with two jumper positions
1-conductor female plug; straight*
Fuse plug; 6 mm wide (every other terminal block)
*1-conductor angled female plug is also possible!



Male connector; with CAGE CLAMP® connection and snap-in mounting feet
1-conductor female plug; straight

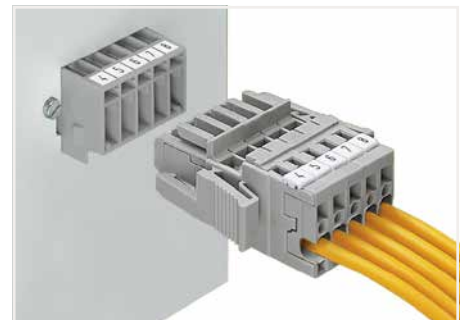

Male header and 1-conductor female plug; with lateral locking levers



2-pin terminal block for pluggable modules; with two jumper positions and separator plate
1-conductor female plug; straight*
Relay plug; 25 mm wide
*1-conductor angled female plug is also possible!

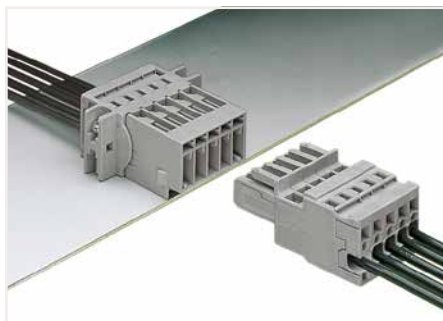

Male connector; with CAGE CLAMP® and mounting flanges
1-conductor female plug; straight

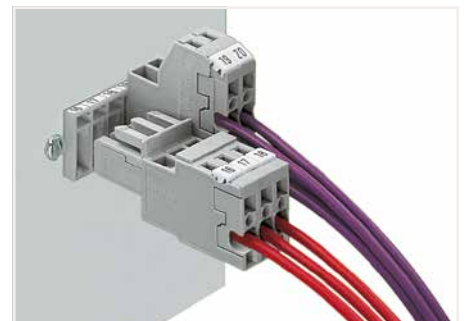

Male header; with feedthrough flanges
1-conductor female plug
2-conductor female plug



1-conductor/1-pin double-deck carrier terminal block
1-conductor female plug; angled*
*1-conductor straight female plug is also possible!



Cable entry into the control cabinet:
The cables are led into the control cabinet with the connected female plugs and are directly plugged onto the carrier terminal blocks.





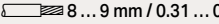

Cable entry in the base of the control cabinet
Separate strain relief, movable IP54 bottom plates sealed with sponge rubber (e.g., by Rittal)

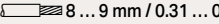
1-Conductor/1-Pin Carrier Terminal Block X-COM®-SYSTEM 4 mm²; 769 Series

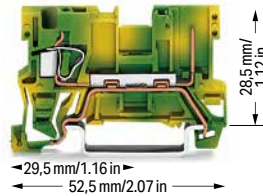
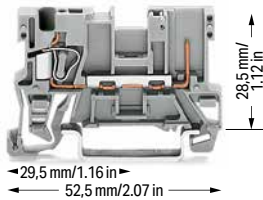
Technical Data	
0.08 ... 4 mm ²	28 ... 12 AWG
500 V/6 kV/3 ①	300 V, 20 A ②
I _N 32 A ②	300 V, 20 A ②
Terminal block width: 5 mm / 0.197 inch	
 8 ... 9 mm / 0.31 ... 0.35 inch	

Technical Data	
0.08 ... 4 mm ²	28 ... 12 AWG
Terminal block width: 5 mm / 0.197 inch	
 8 ... 9 mm / 0.31 ... 0.35 inch	





1-conductor/1-pin carrier terminal block		
Color	Item No.	Pack. Unit
 gray	769-176	100
 blue	769-176/000-006	100
 orange	769-176/000-012	100

1-conductor/1-pin ground carrier terminal block		
Color	Item No.	Pack. Unit
 green-yellow	769-237	100

1-conductor/1-pin carrier terminal block; with shield contact		
Color	Item No.	Pack. Unit
 gray	769-231 ①	50

Accessories; item-specific			
Protective warning marker; with black high-voltage symbol; for 5 terminal blocks			
	yellow	280-415	100 (25)

Accessories; 769 Series
Appropriate marking systems: Mini-WSB/Mini-WSB Inline

End and intermediate plate; 1.1 mm thick			
	orange	769-308	100 (25)
	gray	769-307	100 (25)

Staggered jumper; insulated; 5 mm wide; I _N 24 A			
	1 to 2	780-452	100 (25)
	1 to 3	780-453	100 (25)
	1 to 4	780-454	100 (25)
	1 to 5	780-455	50 (25)
	1 to 6	780-456	50 (25)
	1 to 7	780-457	50 (25)
	1 to 8	780-458	50 (25)

Insulation stop; 0.08 ... 0.2 mm ² "s" (0.14 mm ² "f-st"); 5 pcs/strip			
	white	769-470	200 (25)

Push-in type wire jumper; insulated; 0.75 mm ² conductor cross section; I _N 9 A			
	L = 60 mm	249-125	100 (10)
	L = 110 mm	249-126	100 (10)
	L = 250 mm	249-127	100 (10)

Insulation stop; 0.25 ... 0.5 mm ² ; 5 pcs/strip			
	light gray	769-471	200 (25)

Test plug module; snaps together; 5 mm wide			
	gray	280-418	100 (25)

Insulation stop; 0.75 ... 1 mm ² ; 5 pcs/strip			
	dark gray	769-472	200 (25)

Spacer module; snaps together; 5 mm wide			
	gray	280-419	100 (25)

Coding pin; for coding female plugs			
	orange	769-435	100 (25)

Adjacent jumper; insulated; I _N = I _N terminal block			
	gray	280-402	200 (25)

Test plug; with 500 mm cable; 2 mm Ø; max. 42 V			
	red	210-136	50

Alternate jumper; insulated; I _N = I _N terminal block			
	gray	280-409	100 (25)

① 500 V = rated voltage
6 kV = rated impulse voltage
3 = pollution degree
250 V/4 kV/3 = Nominal voltage with shield contact (see Section 15)

② See current-carrying capacity curve on page 453 and upon request

Please observe the application notes:
Insulation stop, page 382
Jumpers, from page 384
Testing accessories, from page 379
Mini-WSB marking system, page 641

Approvals and corresponding ratings, visit www.wago.com

Accessories; 769 Series
Appropriate marking systems:
Mini-WSB/Mini-WSB Inline

Test plug adapter; 5 mm wide; for 1.5 ... 4 mm² terminal blocks

	gray	280-404	100 (25)
---	------	---------	----------

Pin cover; with Mini-WSB marker slot			
	gray	769-438	100 (25)
	orange	769-439	100 (25)

1-connector female plug; straight			
	gray	769-101	200

1-conductor female plug; angled			
	gray	769-101/022-000	200

2-conductor female plug			
	gray	769-121	100

Mini-WSB Inline, plain; 1,700 WMB markers (5 mm)/reel; 5 ... 5.2 mm stretchable			
	white	2009-145	1

Mini-WSB marking card; white; 10 strips with 10 markers/card; 5 mm wide markers			
	plain	248-501	5

1-Conductor/1-Pin Carrier Terminal Blocks and 1-/2-Conductor Female Plugs X-COM®-SYSTEM Assembly Types



1-conductor female plug
Carrier terminal blocks can be commoned via 280 and 780 Series Jumpers and tested using a test plug adapter (280-4..).

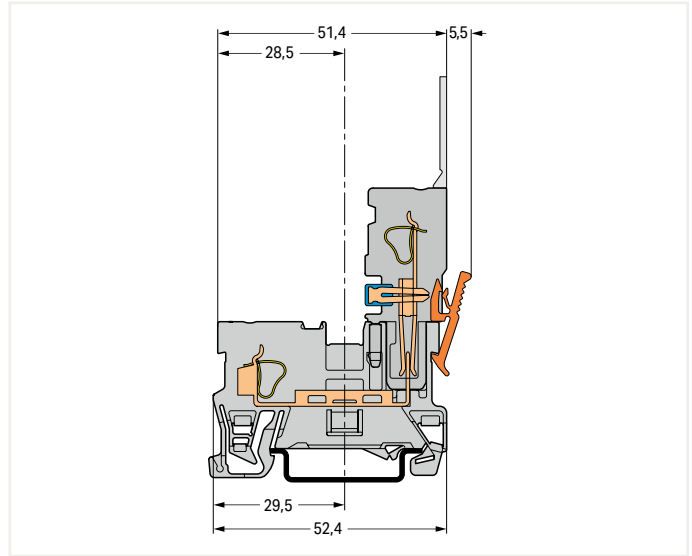

Carrier terminal block



2-conductor female plug
Carrier terminal blocks can only be commoned via 280 Series Adjacent and Alternate Jumpers.

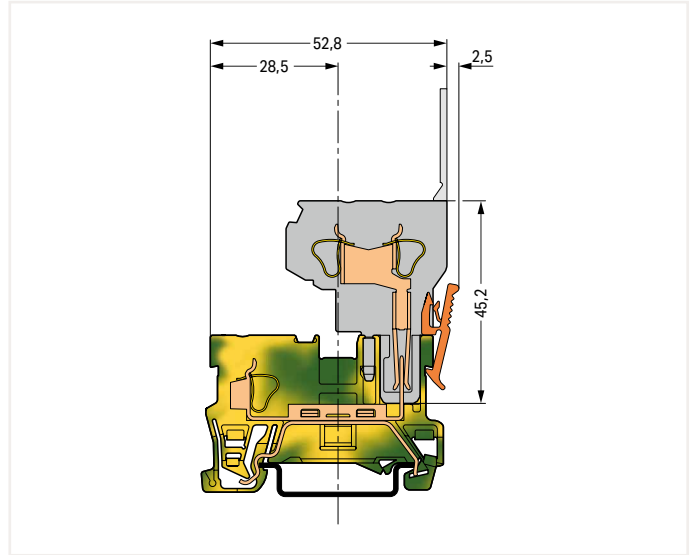

Ground carrier terminal block

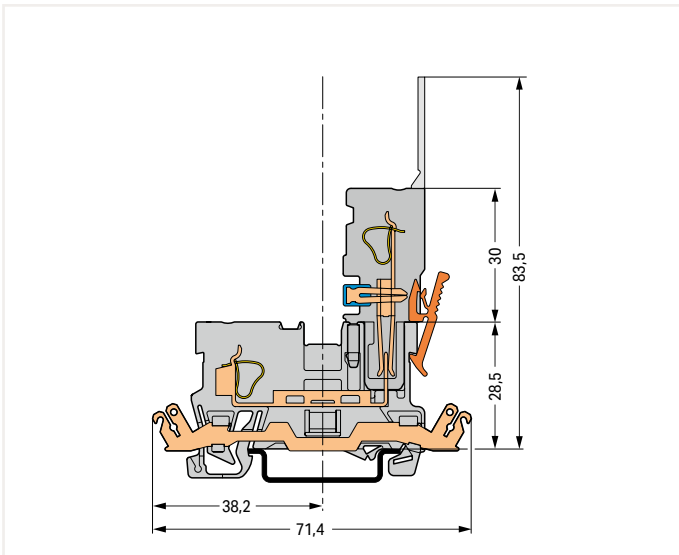

Carrier terminal block; with shield contact

2-Pin Carrier Terminal Block X-COM®-SYSTEM 769 Series

Technical Data

500 V/6 kV/3 ①	300 V, 20 A ②
I _N 32 A ②	300 V, 20 A ②
Terminal block width: 5 mm / 0.197 inch	

Technical Data

Terminal block width: 5 mm / 0.197 inch

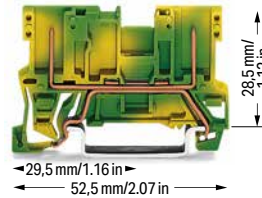
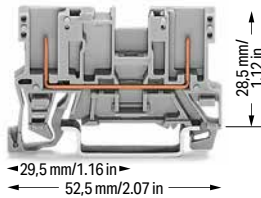

2-Pin Carrier Terminal Block

Color	Item No.	Pack. Unit
gray	769-156	100
blue	769-156/000-006	100

2-pin ground carrier terminal block

Color	Item No.	Pack. Unit
green-yellow	769-227	100

2-pin carrier terminal block; with shield contact

gray	769-221 ①	50
------	-----------	----

Accessories; 769 Series

Appropriate marking systems: Mini-WSB/Mini-WSB Inline

End and intermediate plate; 1.1 mm thick

orange	769-306	100 (25)
gray	769-305	100 (25)

Coding pin; for coding female plugs

orange	769-435	100 (25)
--------	---------	----------

Adjacent jumper; insulated; I_N = I_N terminal block

gray	280-402	200 (25)
------	---------	----------

Alternate jumper; insulated; I_N = I_N terminal block

gray	280-409	100 (25)
------	---------	----------

Staggered jumper; insulated; 5 mm wide; I_N 24 A

1 to 2	780-452	100 (25)
1 to 3	780-453	100 (25)
1 to 4	780-454	100 (25)
1 to 5	780-455	50 (25)
1 to 6	780-456	50 (25)
1 to 7	780-457	50 (25)
1 to 8	780-458	50 (25)

Push-in type wire jumper; insulated; 0.75 mm² conductor cross section; I_N 9 A

L = 60 mm	249-125	100 (10)
L = 110 mm	249-126	100 (10)
L = 250 mm	249-127	100 (10)

Test plug module; snaps together; 5 mm wide

gray	280-418	100 (25)
------	---------	----------

Spacer module; snaps together; 5 mm wide

gray	280-419	100 (25)
------	---------	----------

Test plug adapter; 5 mm wide; for 1.5 ... 4 mm² terminal blocks

gray	280-404	100 (25)
------	---------	----------

Pin cover; with Mini-WSB marker slot

gray	769-438	100 (25)
orange	769-439	100 (25)

1-conductor female plug; straight

gray	769-101	200
------	---------	-----

1-conductor female plug; angled

gray	769-101/022-000	200
------	-----------------	-----

2-conductor female plug

gray	769-121	100
------	---------	-----

Mini-WSB Inline, plain; 1,700 WMB markers (5 mm)/reel; 5 ... 5.2 mm stretchable

white	2009-145	1
-------	----------	---

Mini-WSB marking card; white; 10 strips with 10 markers/card; 5 mm wide markers

plain	248-501	5
-------	---------	---

① 500 V = rated voltage
6 kV = rated impulse voltage
3 = pollution degree
250 V/4 kV/3 = Nominal voltage with shield contact (see Section 15)

② See current-carrying capacity curve and upon request

Please observe the application notes:
Jumpers, from page 384
Testing accessories, from page 379
Mini-WSB marking system, page 641

Approvals and corresponding ratings, visit www.wago.com

7

2-Pin Carrier Terminal Blocks and 1-/2-Conductor Female Plugs X-COM®-SYSTEM Assembly Types



1-Conductor Female Plugs
Carrier terminal blocks can be commoned via 280 and 780 Series Jumpers and tested using a test plug adapter (280-4..).

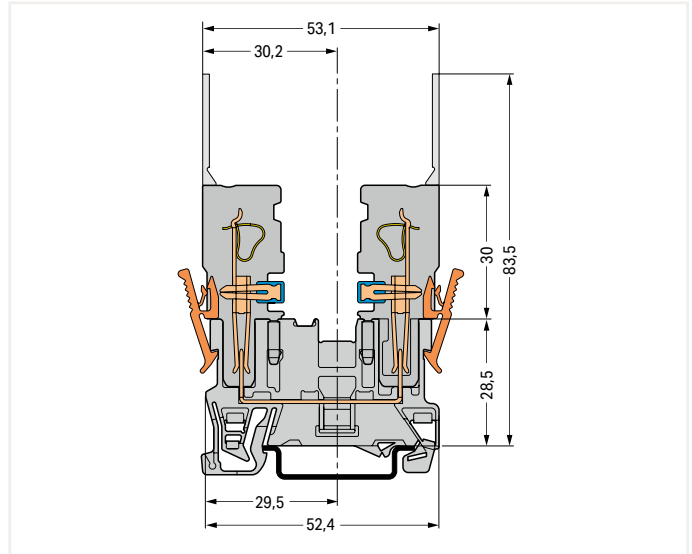

Carrier terminal block



1- and 2-Conductor Female Plug
Carrier terminal blocks can only be commoned via 280 Series Adjacent and Alternate Jumpers.

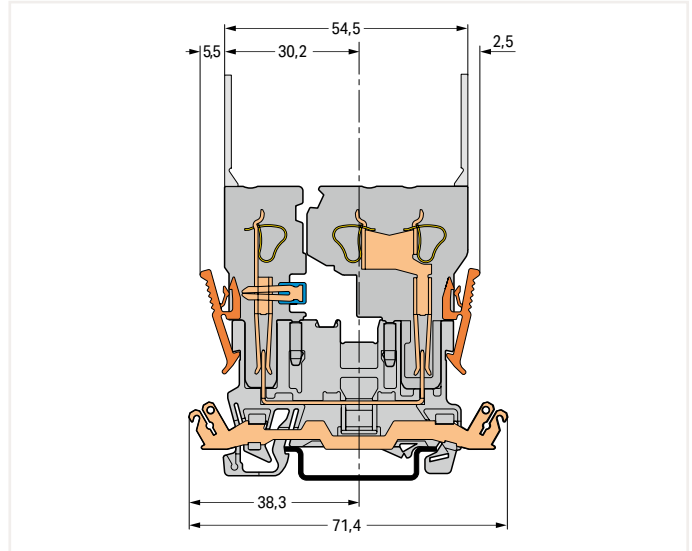

Carrier terminal block; with shield contact



2- and 1-Conductor Female Plug
Carrier terminal blocks can be commoned via 280 and 780 Series Jumpers.

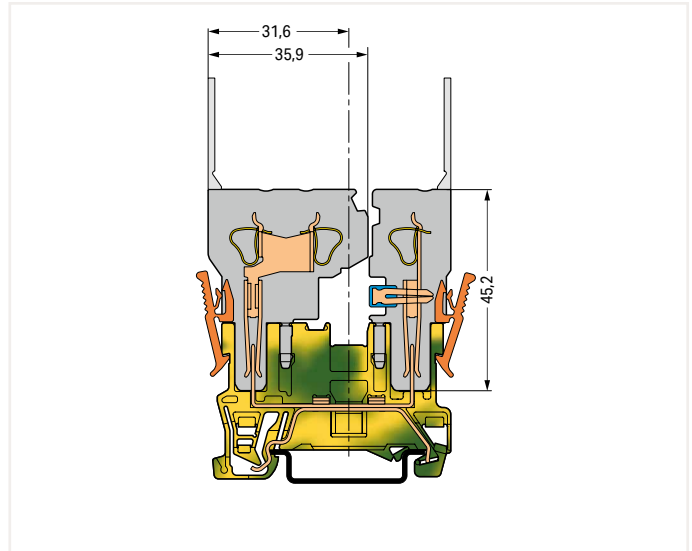

Ground carrier terminal block

2-Conductor/2-Pin Carrier Terminal Block X-COM®-SYSTEM 4 mm²; 769 Series

Technical Data

0.08 ... 4 mm ²	28 ... 12 AWG
500 V/6 kV/3 ①	300 V, 20 A ②
I _N 32 A ②	300 V, 20 A ②
Terminal block width: 5 mm / 0.197 inch	
8 ... 9 mm / 0.31 ... 0.35 inch	

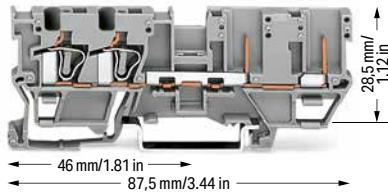

2-conductor/2-pin carrier terminal block

Color	Item No.	Pack. Unit
gray	769-171	50
blue	769-171/000-006	50

2-conductor/2-pin carrier terminal block; with shield contact

gray	769-211 ①	50
------	-----------	----

Accessories; item-specific

Protective warning marker; with black high-voltage symbol; for 5 terminal blocks

yellow	280-415	100 (25)
--------	---------	----------

Accessories; 769 Series

Appropriate marking systems: Mini-WSB/Mini-WSB Inline

End and intermediate plate; 1.1 mm thick

orange	769-304	100 (25)
gray	769-303	100 (25)

Insulation stop; 0.08 ... 0.2 mm² "s" (0.14 mm² "f-st"); 5 pcs/strip

white	769-470	200 (25)
-------	---------	----------

Insulation stop; 0.25 ... 0.5 mm²; 5 pcs/strip

light gray	769-471	200 (25)
------------	---------	----------

Insulation stop; 0.75 ... 1 mm²; 5 pcs/strip

dark gray	769-472	200 (25)
-----------	---------	----------

Coding pin; for coding female plugs

orange	769-435	100 (25)
--------	---------	----------

Adjacent jumper; insulated; I_N = I_N terminal block

gray	280-402	200 (25)
------	---------	----------

Alternate jumper; insulated; I_N = I_N terminal block

gray	280-409	100 (25)
------	---------	----------

Technical Data

0.08 ... 4 mm ²	28 ... 12 AWG
Terminal block width: 5 mm / 0.197 inch	
8 ... 9 mm / 0.31 ... 0.35 inch	

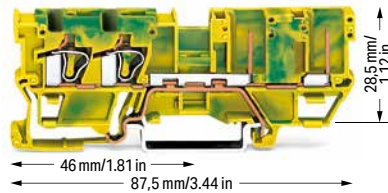

2-conductor/2-pin ground carrier terminal block

green-yellow	769-217	50
--------------	---------	----

① 500 V = rated voltage
6 kV = rated impulse voltage
3 = pollution degree
250 V/4 kV/3 = Nominal voltage with shield contact (see Section 15)

② See current-carrying capacity curve on page 454 and upon request

Note: 1-conductor angled female plugs cannot be used.

Please observe the application notes:
Insulation stop, page 382
Jumpers, from page 384
Testing accessories, from page 378
Mini-WSB marking system, page 641

Approvals and corresponding ratings, visit www.wago.com

Accessories; 769 Series

Appropriate marking systems:
Mini-WSB/Mini-WSB Inline

Test plug adapter; 5 mm wide; for 1.5 ... 4 mm² terminal blocks

gray	280-404	100 (25)
------	---------	----------

Pin cover; with Mini-WSB marker slot

gray	769-438	100 (25)
orange	769-439	100 (25)

1-connector female plug; straight

gray	769-101	200
------	---------	-----

2-conductor female plug

gray	769-121	100
------	---------	-----

Mini-WSB Inline, plain; 1,700 WMB markers (5 mm)/reel; 5 ... 5.2 mm stretchable

white	2009-145	1
-------	----------	---

Mini-WSB marking card; white; 10 strips with 10 markers/card; 5 mm wide markers

plain	248-501	5
-------	---------	---

Staggered jumper; insulated; 5 mm wide; I_N 24 A

1 to 2	780-452	100 (25)
1 to 3	780-453	100 (25)
1 to 4	780-454	100 (25)
1 to 5	780-455	50 (25)
1 to 6	780-456	50 (25)
1 to 7	780-457	50 (25)
1 to 8	780-458	50 (25)

Push-in type wire jumper; insulated; 0.75 mm² conductor cross section; I_N 9 A

L = 60 mm	249-125	100 (10)
L = 110 mm	249-126	100 (10)
L = 250 mm	249-127	100 (10)

Test plug module; snaps together; 5 mm wide

gray	280-418	100 (25)
------	---------	----------

Spacer module; snaps together; 5 mm wide

gray	280-419	100 (25)
------	---------	----------

Test plug; with 500 mm cable; 2 mm Ø; max. 42 V

red	210-136	50
-----	---------	----

7

2-Conductor/2-Pin Carrier Terminal Blocks and 1-/2-Conductor Female Plugs X-COM®-SYSTEM Assembly Types

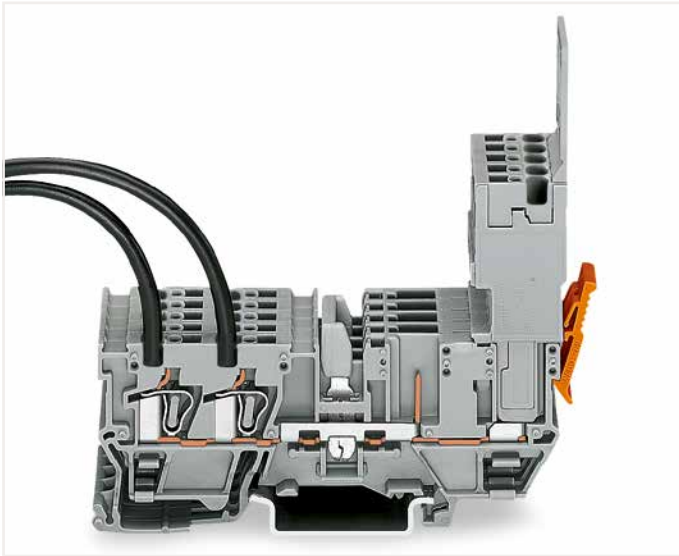

1-conductor female plug
Carrier terminal blocks can be commoned via 280 and 780 Series Jumpers and tested using a test plug adapter (280-4..).

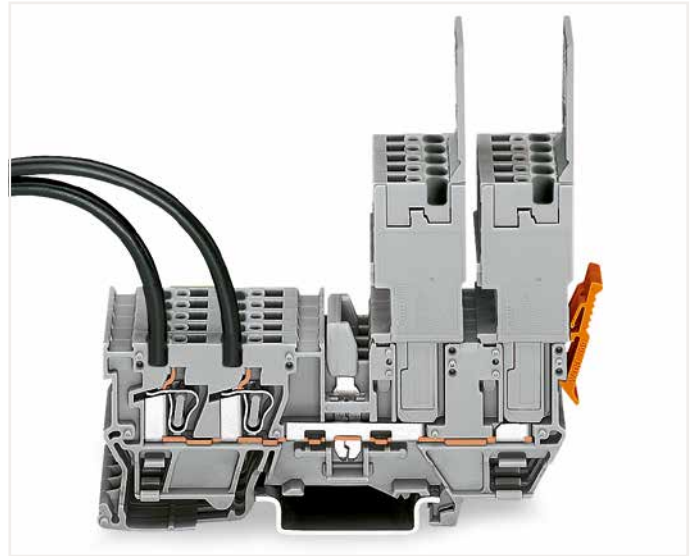

2 x 1-conductor female plugs
Carrier terminal blocks can be commoned via 280 and 780 Series Jumpers and tested using a test plug adapter (280-4..).

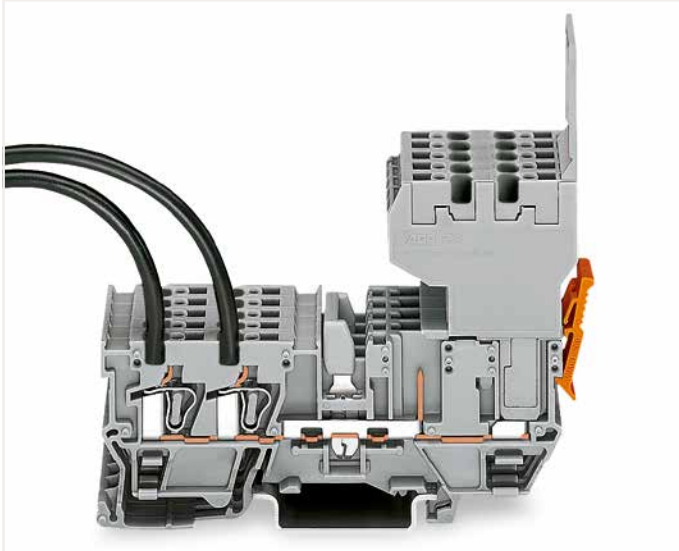

2-conductor female plug
Carrier terminal blocks can be commoned via 280 and 780 Series Jumpers and tested using a test plug adapter (280-4..).

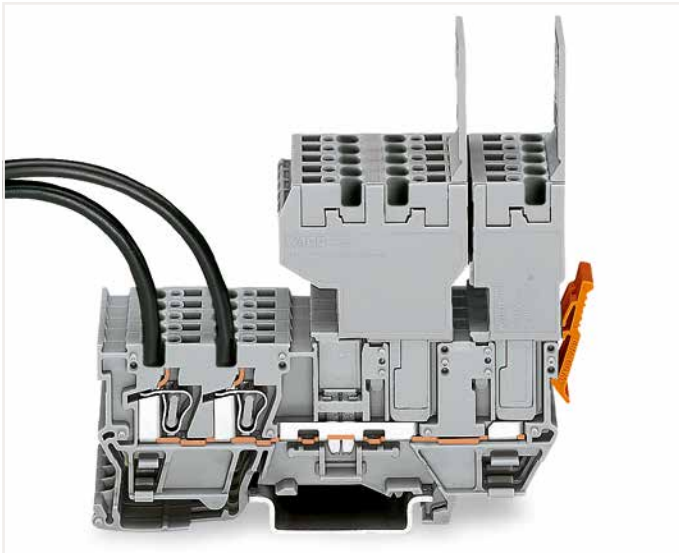
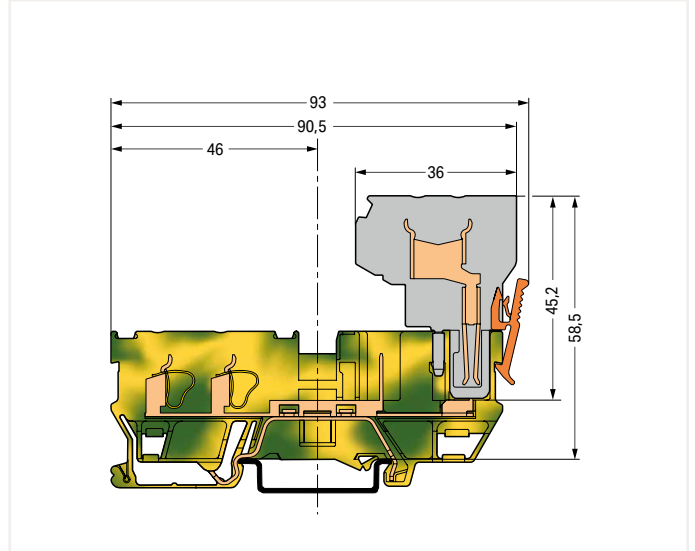

1- and 2-Conductor Female Plug
Carrier terminal blocks can only be commoned via 280 Series Adjacent and Alternate Jumpers.

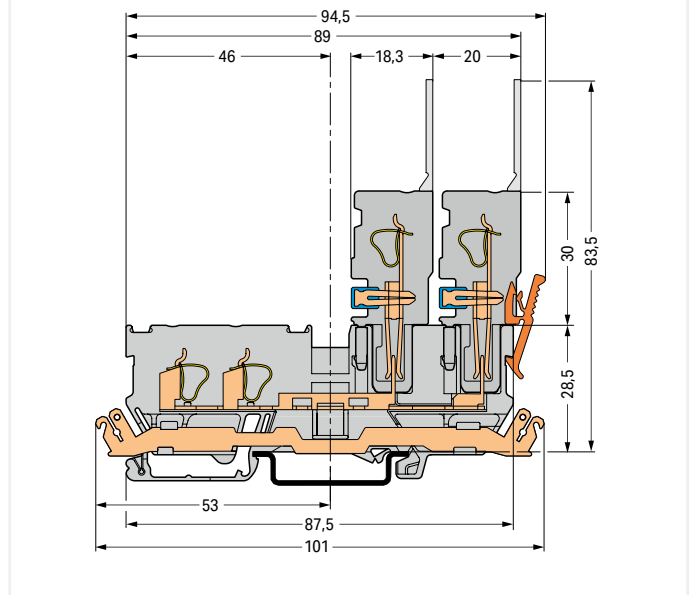

Ground carrier terminal block
Carrier terminal block; with shield contact

4-Pin Carrier Terminal Block X-COM®-SYSTEM 769 Series

Technical Data

500 V/6 kV/3 ①	300 V, 20 A ②
I _N 32 A ②	300 V, 20 A ②
Terminal block width: 5 mm / 0.197 inch	

Technical Data

Terminal block width: 5 mm / 0.197 inch

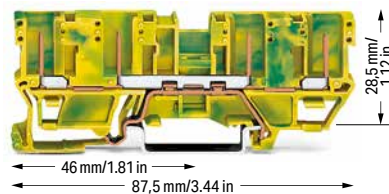
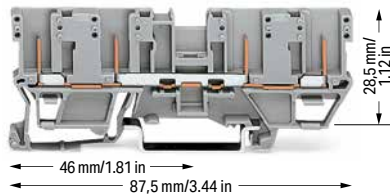

4-pin carrier terminal block

Color	Item No.	Pack. Unit
○ gray	769-151	50

4-pin ground carrier terminal block

Color	Item No.	Pack. Unit
● green-yellow	769-207	50

4-pin carrier terminal block; with shield contact

○ gray	769-201 ①	50
--------	-----------	----

Accessories; 769 Series

Appropriate marking systems: Mini-WSB/Mini-WSB Inline

End and intermediate plate; 1.1 mm thick

orange	769-302	100 (25)
gray	769-301	100 (25)

Coding pin; for coding female plugs

orange	769-435	100 (25)
--------	---------	----------

Adjacent jumper; insulated; I_N = I_N terminal block

gray	280-402	200 (25)
------	---------	----------

Alternate jumper; insulated; I_N = I_N terminal block

gray	280-409	100 (25)
------	---------	----------

Staggered jumper; insulated; 5 mm wide; I_N 24 A

1 to 2	780-452	100 (25)
1 to 3	780-453	100 (25)
1 to 4	780-454	100 (25)
1 to 5	780-455	50 (25)
1 to 6	780-456	50 (25)
1 to 7	780-457	50 (25)
1 to 8	780-458	50 (25)

Push-in type wire jumper; insulated; 0.75 mm² conductor cross section; I_N 9 A

L = 60 mm	249-125	100 (10)
L = 110 mm	249-126	100 (10)
L = 250 mm	249-127	100 (10)

Test plug module; snaps together; 5 mm wide

gray	280-418	100 (25)
------	---------	----------

Spacer module; snaps together; 5 mm wide

gray	280-419	100 (25)
------	---------	----------

Test plug adapter; 5 mm wide; for 1.5 ... 4 mm² terminal blocks

gray	280-404	100 (25)
------	---------	----------

Pin cover; with Mini-WSB marker slot

gray	769-438	100 (25)
orange	769-439	100 (25)

1-conductor female plug; straight

gray	769-101	200
------	---------	-----

2-conductor female plug

gray	769-121	100
------	---------	-----

Mini-WSB Inline, plain; 1,700 WMB markers (5 mm)/reel; 5 ... 5.2 mm stretchable

white	2009-145	1
-------	----------	---

Mini-WSB marking card; white; 10 strips with 10 markers/card; 5 mm wide markers

plain	248-501	5
-------	---------	---

① 500 V = rated voltage
6 kV = rated impulse voltage
3 = pollution degree
250 V/4 kV/3 = Nominal voltage with shield contact (see Section 15)

② See current-carrying capacity curve on page 454 and upon request

Note: 1-conductor angled female plugs cannot be used.

Please observe the application notes:
Jumpers, from page 384
Testing accessories, from page 379
Mini-WSB marking system, page 641

Approvals and corresponding ratings, visit www.wago.com

7

4-Pin Carrier Terminal Blocks and 1-/2-Conductor Female Plugs X-COM®-SYSTEM Assembly Types



4 x 1-conductor female plugs
Carrier terminal blocks can be commoned via 280 and 780 Series Jumpers and tested using a test plug adapter (280-4..).

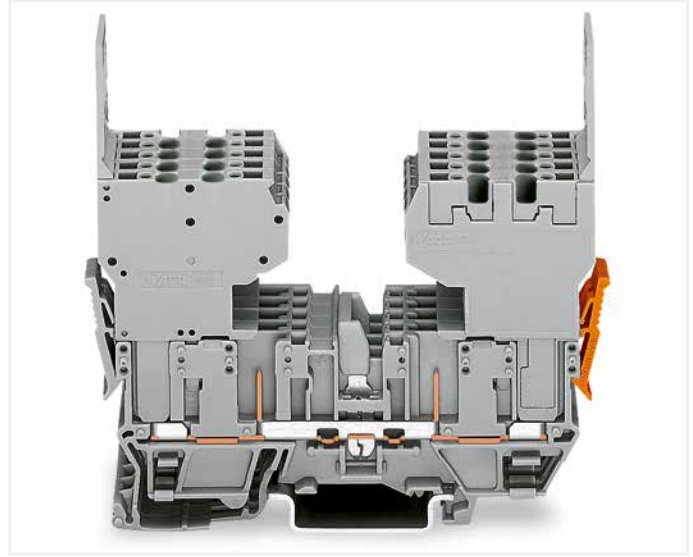

2 x 2-conductor female plugs
Carrier terminal blocks can be commoned via 280 and 780 Series Jumpers and tested using a test plug adapter (280-4..).



2 x 1-conductor female plug (left), 1 x 2-conductor female plug (right), may be reversed – carrier terminal blocks can be commoned via 280 and 780 Series Jumpers and tested using a test plug adapter (280-4..).

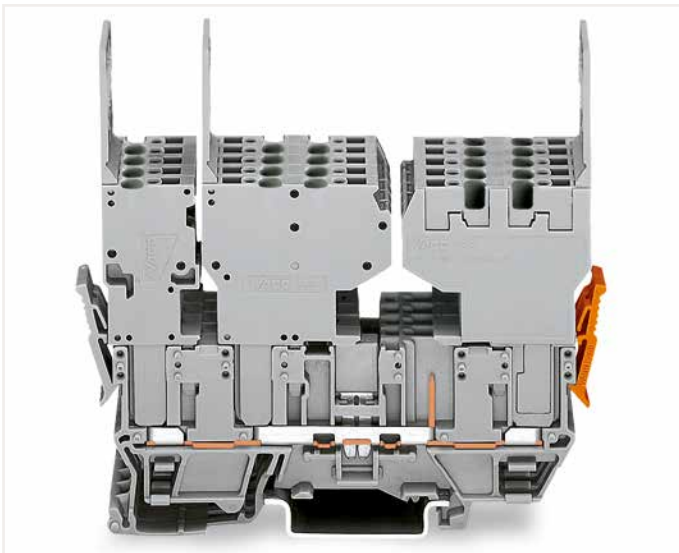
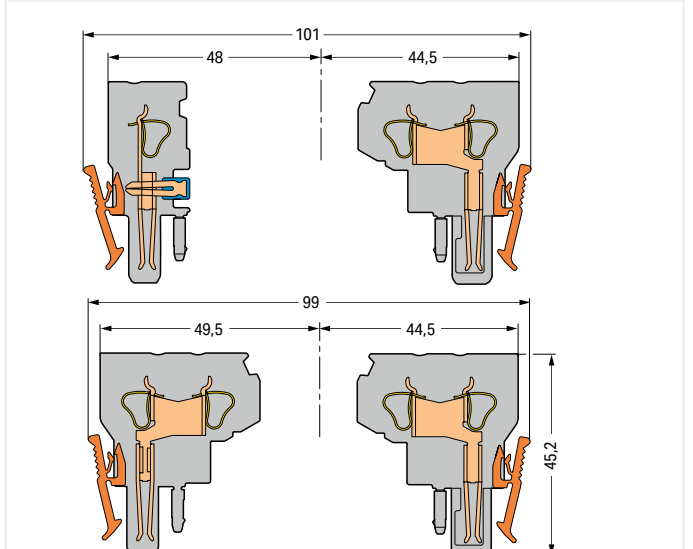

1-conductor and 2-conductor female plugs (left), 2-conductor female plug (right), may be reversed – carrier terminal blocks can only be commoned via 280 Series Adjacent and Alternate Jumpers.

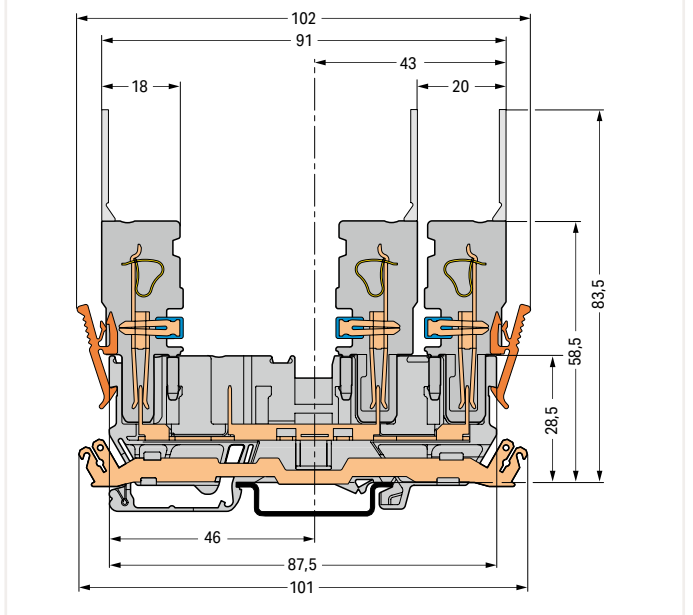

Carrier terminal block; with shield contact

2-Conductor/1-Pin Carrier Terminal Block X-COM®-SYSTEM 4 mm²; 769 Series

Technical Data

0.08 ... 4 mm ²	28 ... 12 AWG
500 V/6 kV/3 ①	300 V, 20 A ②
I _N 32 A ②	300 V, 20 A ②
Terminal block width: 5 mm / 0.197 inch	
8 ... 9 mm / 0.31 ... 0.35 inch	

Technical Data

0.08 ... 4 mm ²	28 ... 12 AWG
Terminal block width: 5 mm / 0.197 inch	
8 ... 9 mm / 0.31 ... 0.35 inch	

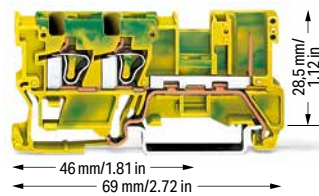
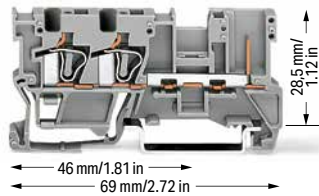

2-Conductor/1-Pin Carrier Terminal Block

Color	Item No.	Pack. Unit
gray	769-251	50
blue	769-251/000-006	50

1-conductor/1-pin ground carrier terminal block

Color	Item No.	Pack. Unit
green-yellow	769-257	50

Accessories; item-specific

Protective warning marker; with black high-voltage symbol; for 5 terminal blocks

yellow	280-415	100 (25)
--------	---------	----------

Accessories; 769 Series

Appropriate marking systems: Mini-WSB/Mini-WSB Inline

End and intermediate plate; 1.1 mm thick

orange	769-321	100 (25)
gray	769-320	100 (25)

Insulation stop; 0.08 ... 0.2 mm² "s" (0.14 mm² "f-st"); 5 pcs/strip

white	769-470	200 (25)
-------	---------	----------

Insulation stop; 0.25 ... 0.5 mm²; 5 pcs/strip

light gray	769-471	200 (25)
------------	---------	----------

Insulation stop; 0.75 ... 1 mm²; 5 pcs/strip

dark gray	769-472	200 (25)
-----------	---------	----------

Coding pin; for coding female plugs

orange	769-435	100 (25)
--------	---------	----------

Adjacent jumper; insulated; I_N = I_N terminal block

gray	280-402	200 (25)
------	---------	----------

Alternate jumper; insulated; I_N = I_N terminal block

gray	280-409	100 (25)
------	---------	----------

Push-in type wire jumper; insulated; 0.75 mm² conductor cross section; I_N 9 A

L = 60 mm	249-125	100 (10)
L = 110 mm	249-126	100 (10)
L = 250 mm	249-127	100 (10)

Staggered jumper; insulated; 5 mm wide; I_N 24 A

1 to 2	780-452	100 (25)
1 to 3	780-453	100 (25)
1 to 4	780-454	100 (25)
1 to 5	780-455	50 (25)
1 to 6	780-456	50 (25)
1 to 7	780-457	50 (25)
1 to 8	780-458	50 (25)

Test plug module; snaps together; 5 mm wide

gray	280-418	100 (25)
------	---------	----------

Spacer module; snaps together; 5 mm wide

gray	280-419	100 (25)
------	---------	----------

B-type test plug module; snaps together; 5 mm wide

gray	249-106	100 (25)
------	---------	----------

Test plug; with 500 mm cable; 2 mm Ø; max. 42 V

red	210-136	50
-----	---------	----

Test plug adapter; 5 mm wide; for 1.5 ... 4 mm² terminal blocks

gray	280-404	100 (25)
------	---------	----------

① 500 V = rated voltage
6 kV = rated impulse voltage
3 = pollution degree
(see Section 15)

② Current-carrying capacity curves upon request

Please observe the application notes:
Insulation stop, page 382
Jumpers, from page 384
Testing accessories, from page 378
Mini-WSB marking system, page 641

Approvals and corresponding ratings,
visit www.wago.com

Accessories; 769 Series

Appropriate marking systems:
Mini-WSB/Mini-WSB Inline

Pin cover; with Mini-WSB marker slot

gray	769-438	100 (25)
orange	769-439	100 (25)

1-connector female plug; straight

gray	769-101	200
------	---------	-----

1-conductor female plug; angled

gray	769-101/022-000	200
------	-----------------	-----

2-conductor female plug

gray	769-121	100
------	---------	-----

Mini-WSB Inline, plain; 1,700 WMB markers (5 mm)/reel; 5 ... 5.2 mm stretchable

white	2009-145	1
-------	----------	---

Mini-WSB marking card; white; 10 strips with 10 markers/card; 5 mm wide markers

plain	248-501	5
-------	---------	---

7

2-Conductor/1-Pin Carrier Terminal Blocks and 1-/2-Conductor Female Plugs X-COM®-SYSTEM Assembly Types

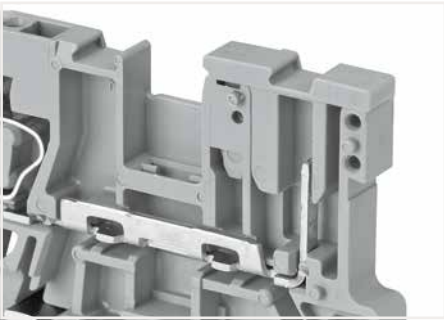

Pin cover (769-438); with Mini-WSB marker slot



1-conductor female plug
Carrier terminal blocks can be commoned via 280 and 780 Series Jumpers and tested using a test plug adapter (280-4..).

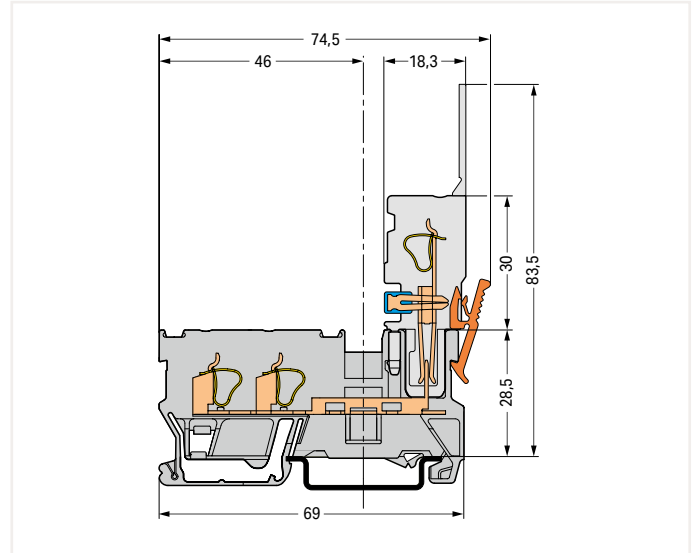

Carrier terminal block

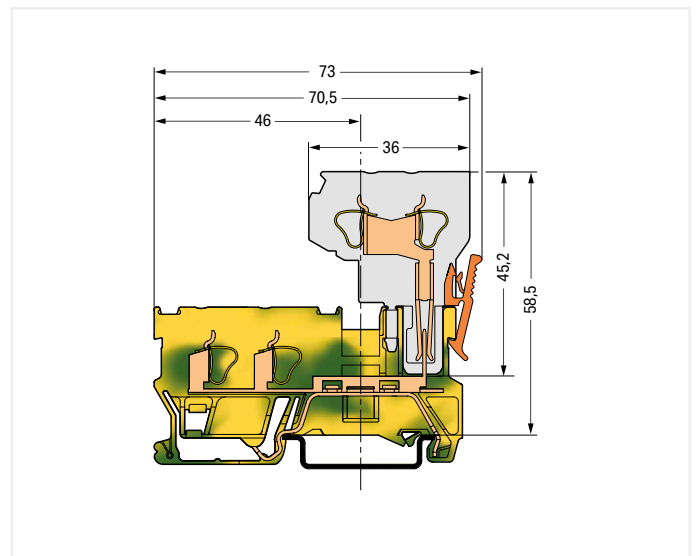

Ground carrier terminal block

1-Conductor/1-Pin Carrier Terminal Block X-COM®-SYSTEM; with Three Jumper Positions 4 mm²; 769 Series

Technical Data

0.08 ... 4 mm ²	28 ... 12 AWG
500 V/6 kV/3 ①	300 V, 20 A
I _N 32 A ②	300 V, 20 A @
Terminal block width: 5 mm / 0.197 inch	
8 ... 9 mm / 0.31 ... 0.35 inch	

- ① 500 V = rated voltage
6 kV = rated impulse voltage
3 = pollution degree
(see Section 15)
 - ② Current-carrying capacity curves upon request
- Please observe the application notes:
Insulation stop, page 382
Mini-WSB marking system, page 641
- Approvals and corresponding ratings,
visit www.wago.com

Accessories; 769 Series

Appropriate marking systems:
Mini-WSB/Mini-WSB Inline

1-conductor female plug; straight			
	gray	769-101	200

1-conductor female plug; angled			
	gray	769-101/022-000	200

2-conductor female plug			
	gray	769-121	100

Mini-WSB Inline, plain; 1,700 WMB markers (5 mm)/reel; 5 ... 5.2 mm stretchable			
	white	2009-145	1

Mini-WSB marking card; white; 10 strips with 10 markers/ card; 5 mm wide markers			
	plain	248-501	5

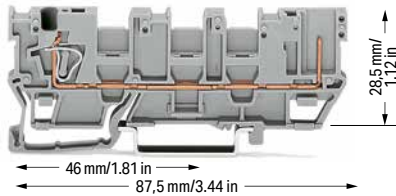

1-conductor/1-pin carrier terminal block; with three jumper positions

Color	Item No.	Pack. Unit
	769-214	50

Accessories; 769 Series

Appropriate marking systems:
Mini-WSB/Mini-WSB Inline

End and intermediate plate; 1.1 mm thick

	orange	769-316	100 (25)
	gray	769-315	100 (25)

Insulation stop; 0.08 ... 0.2 mm² "s" (0.14 mm² "f-st"); 5 pcs/strip

	white	769-470	200 (25)
--	-------	---------	----------

Insulation stop; 0.25 ... 0.5 mm²; 5 pcs/strip

	light gray	769-471	200 (25)
--	------------	---------	----------

Accessories; 769 Series

Appropriate marking systems:
Mini-WSB/Mini-WSB Inline

Insulation stop; 0.75 ... 1 mm²; 5 pcs/strip

	dark gray	769-472	200 (25)
--	-----------	---------	----------

Coding pin; for coding female plugs

	orange	769-435	100 (25)
--	--------	---------	----------

Adjacent jumper; insulated; I_N = I_N terminal block

	gray	280-402	200 (25)
--	------	---------	----------

Alternate jumper; insulated; I_N = I_N terminal block

	gray	280-409	100 (25)
--	------	---------	----------

Pin cover; with Mini-WSB marker slot

	gray	769-438	100 (25)
	orange	769-439	100 (25)

7

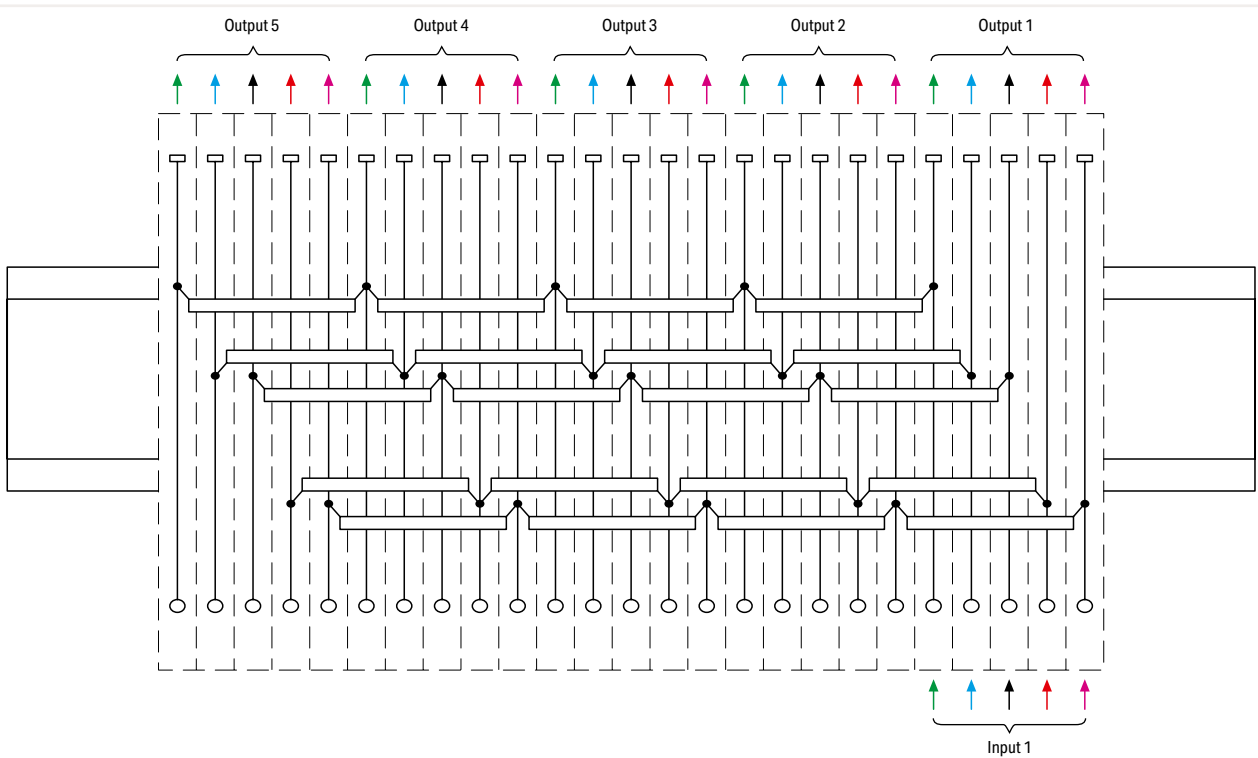

1-Conductor/1-Pin Carrier Terminal Blocks and 1-/2-Conductor Female Plugs X-COM®-SYSTEM Assembly Types

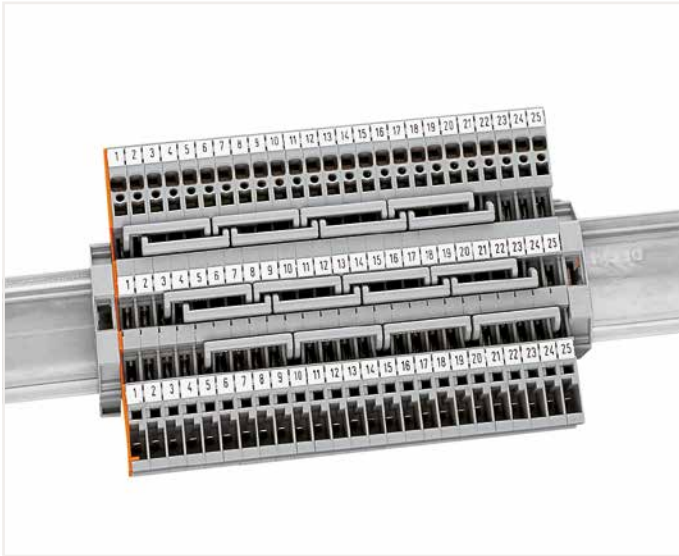

1-conductor/1-pin carrier terminal blocks; with three jumper positions
The three jumper positions allow up to six commoning options for staggered jumpers.

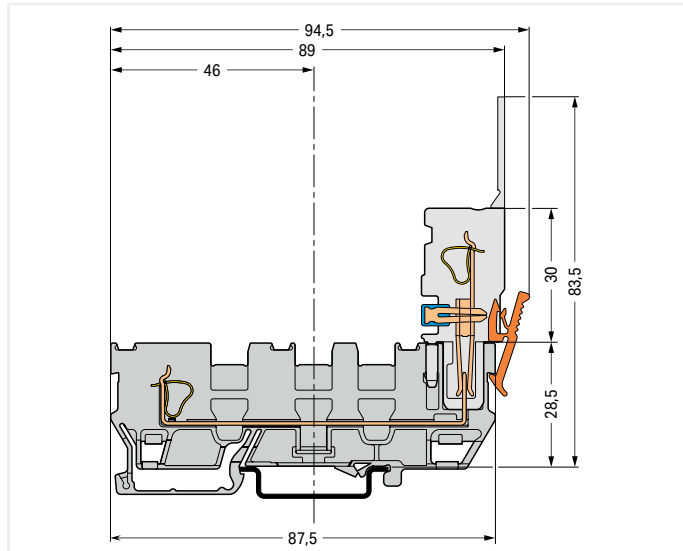
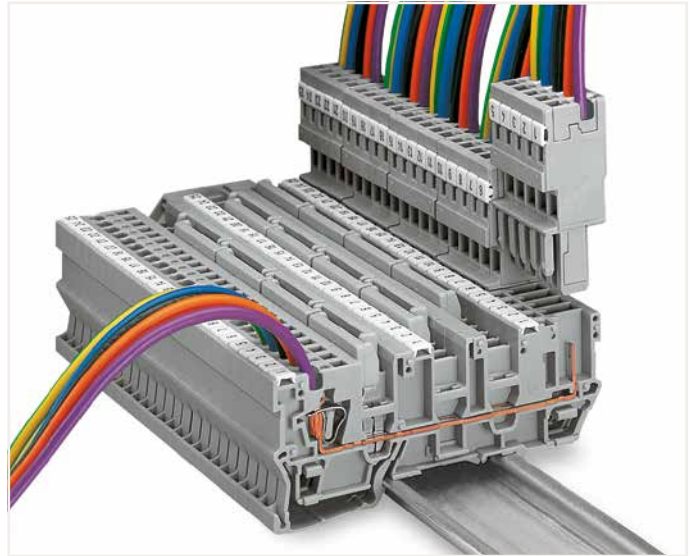

Carrier terminal block

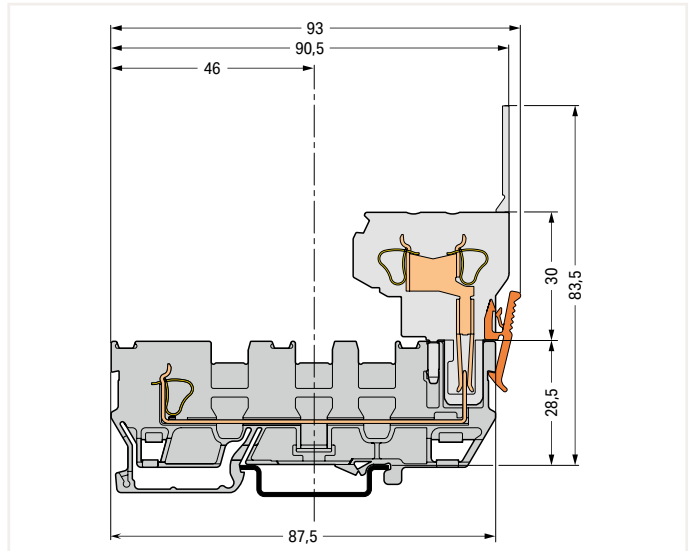

Carrier terminal block

Application examples:

Multiplication of three-phase circuits L1-L2-L3-N-PE
with pluggable outputs (e.g., for motors, frequency converters, power units)
Voltage supplies to multiple locations
(e.g., ±15 V, 0 V, +5 V, +12 V, +24 V)
Various wire-to-wire interfacing possibilities

1-Conductor/1-Pin and 2-Pin Disconnect Carrier Terminal Block X-COM®-SYSTEM 4 mm²; 769 Series

Technical Data	
0.08 ... 4 mm ²	28 ... 12 AWG
400 V/6 kV/3 ①	300 V, 20 A ②
I _N 16 A ②	300 V, 20 A ③
Terminal block width: 5 mm / 0.197 inch	
8 ... 9 mm / 0.31 ... 0.35 inch	

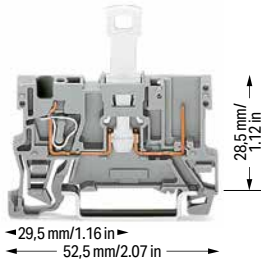

Technical Data	
400 V/6 kV/3 ①	300 V, 20 A ②
I _N 16 A ②	300 V, 20 A ③
Terminal block width: 5 mm / 0.197 inch	

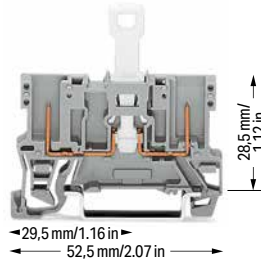

① 400 V = rated voltage
6 kV = rated impulse voltage
3 = pollution degree
250 V/4 kV/3 = Nominal voltage with shield contact (see Section 15)

② 16 A, 85°C upper temperature limit, current-carrying capacity curves upon request

Note: 2-conductor female plugs cannot be used.

Please observe the application notes:
Insulation stop, page 382
Mini-WSB marking system, page 641

Approvals and corresponding ratings, visit www.wago.com

Accessories; 769 Series

Appropriate marking systems:
Mini-WSB/Mini-WSB Inline

Mini-WSB Inline, plain; 1,700 WMB markers (5 mm)/reel; 5 ... 5.2 mm stretchable

white	2009-145	1
-------	----------	---

Mini-WSB marking card; white; 10 strips with 10 markers/ card; 5 mm wide markers

plain	248-501	5
-------	---------	---

1-conductor/1-pin disconnect carrier terminal block		
Color	Item No.	Pack. Unit
○ gray	769-232	50

2-pin disconnect carrier terminal block		
Color	Item No.	Pack. Unit
○ gray	769-222	50

1-conductor/1-pin disconnect carrier terminal block; with shield contact		
Color	Item No.	Pack. Unit
○ gray	769-233 ①	50

2-pin disconnect carrier terminal block; with shield contact		
Color	Item No.	Pack. Unit
○ gray	769-223 ①	50

Accessories; item-specific

End and intermediate plate; 1.1 mm thick			
Color	Item No.	Pack. Unit	Quantity
orange	769-308	100 (25)	
gray	769-307	100 (25)	

Accessories; item-specific

End and intermediate plate; 1.1 mm thick			
Color	Item No.	Pack. Unit	Quantity
orange	769-306	100 (25)	
gray	769-305	100 (25)	

Insulation stop; 0.08 ... 0.2 mm ² "s" (0.14 mm ² "f-st"); 5 pcs/strip			
Color	Item No.	Pack. Unit	Quantity
white	769-470	200 (25)	

Insulation stop; 0.25 ... 0.5 mm ² ; 5 pcs/strip			
Color	Item No.	Pack. Unit	Quantity
light gray	769-471	200 (25)	

Insulation stop; 0.75 ... 1 mm ² ; 5 pcs/strip			
Color	Item No.	Pack. Unit	Quantity
dark gray	769-472	200 (25)	

Protective warning marker; with black high-voltage symbol; for 5 terminal blocks			
Color	Item No.	Pack. Unit	Quantity
yellow	280-415	100 (25)	

Test plug; with 500 mm cable; 2 mm Ø; max. 42 V			
Color	Item No.	Pack. Unit	Quantity
red	210-136	50	

Accessories; 769 Series
Appropriate marking systems: Mini-WSB/Mini-WSB Inline

Coding pin; for coding female plugs			
Color	Item No.	Pack. Unit	Quantity
orange	769-435	100 (25)	

1-connector female plug; straight			
Color	Item No.	Pack. Unit	Quantity
gray	769-101	200	

Disconnect lock; for disconnect tab used on disconnect terminal blocks (280/281 and 769 Series)			
Color	Item No.	Pack. Unit	Quantity
red	709-170	200 (25)	

1-conductor female plug; angled			
Color	Item No.	Pack. Unit	Quantity
gray	769-101/022-000	200	

7

1-Conductor/1-Pin and 2-Pin Disconnect Carrier Terminal Block X-COM®-SYSTEM; with Two Jumper Positions

4 mm²; 769 Series

Technical Data	
0.08 ... 4 mm ²	28 ... 12 AWG
400 V/6 kV/3 ①	300 V, 20 A ②
I _N 16 A ②	300 V, 20 A ③
Terminal block width: 5 mm / 0.197 inch	
 8 ... 9 mm / 0.31 ... 0.35 inch	

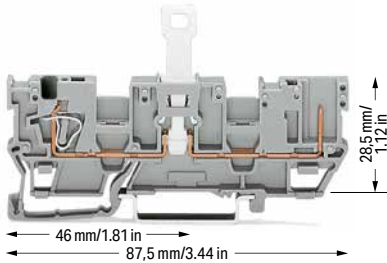



1-conductor/1-pin disconnect carrier terminal block; with two jumper positions

Color	Item No.	Pack. Unit
○ gray	769-212	50

1-conductor/1-pin disconnect carrier terminal block; with shield contact; with two jumper positions

○ gray	769-213 ①	50
--------	-----------	----

Accessories; item-specific

End and intermediate plate; 1.1 mm thick			
	orange	769-312	100 (25)
	gray	769-311	100 (25)

Separator; oversized; 1.1 mm thick

	orange	769-314	100 (25)
---	--------	---------	----------

Insulation stop; 0.08 ... 0.2 mm² "s" (0.14 mm² "f-st"); 5 pcs/strip

	white	769-470	200 (25)
---	-------	---------	----------

Insulation stop; 0.25 ... 0.5 mm²; 5 pcs/strip

	light gray	769-471	200 (25)
---	------------	---------	----------

Insulation stop; 0.75 ... 1 mm²; 5 pcs/strip

	dark gray	769-472	200 (25)
---	-----------	---------	----------

Protective warning marker; with black high-voltage symbol; for 5 terminal blocks

	yellow	280-415	100 (25)
---	--------	---------	----------

Test plug; with 500 mm cable; 2 mm Ø; max. 42 V

	red	210-136	50
---	-----	---------	----

Accessories; 769 Series

Appropriate marking systems: Mini-WSB/Mini-WSB Inline

Coding pin; for coding female plugs

	orange	769-435	100 (25)
---	--------	---------	----------

Technical Data	
400 V/6 kV/3 ①	300 V, 20 A ②
I _N 16 A ②	300 V, 20 A ③
Terminal block width: 5 mm / 0.197 inch	

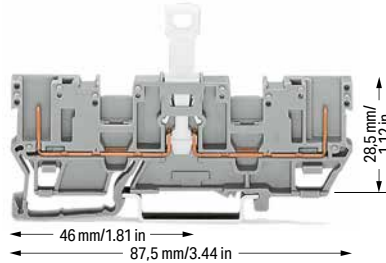



2-pin disconnect carrier terminal block; with two jumper positions

Color	Item No.	Pack. Unit
○ gray	769-202	50

2-pin disconnect carrier terminal block; with shield contact; with two jumper positions

○ gray	769-203 ①	50
--------	-----------	----

Accessories; item-specific

End and intermediate plate; 1.1 mm thick			
	orange	769-310	100 (25)
	gray	769-309	100 (25)

Separator; oversized; 1.1 mm thick

	orange	769-313	100 (25)
---	--------	---------	----------

① 400 V = rated voltage
6 kV = rated impulse voltage
3 = pollution degree
250 V/4 kV/3 = Nominal voltage with shield contact (see Section 15)

② 16 A, 85°C upper temperature limit, current-carrying capacity curves upon request

Please observe the application notes:

Insulation stop, page 382

Jumpers, from page 384

Testing accessories, from page 344

Mini-WSB marking system, page 641

Approvals and corresponding ratings, visit www.wago.com

Accessories; 769 Series

Appropriate marking systems:
Mini-WSB/Mini-WSB Inline

Adjacent jumper; insulated; I_N = I_N terminal block

	gray	280-402	200 (25)
---	------	---------	----------

Alternate jumper; insulated; I_N = I_N terminal block

	gray	280-409	100 (25)
---	------	---------	----------

Staggered jumper; insulated; 5 mm wide; I_N 24 A

	1 to 2	780-452	100 (25)
	1 to 3	780-453	100 (25)
	1 to 4	780-454	100 (25)
	1 to 5	780-455	50 (25)
	1 to 6	780-456	50 (25)
	1 to 7	780-457	50 (25)
	1 to 8	780-458	50 (25)

Push-in type wire jumper; insulated; 0.75 mm² conductor cross section; I_N 9 A

	L = 60 mm	249-125	100 (10)
	L = 110 mm	249-126	100 (10)
	L = 250 mm	249-127	100 (10)

Test plug module; snaps together; 5 mm wide

	gray	280-418	100 (25)
---	------	---------	----------

1-connector female plug; straight

	gray	769-101	200
---	------	---------	-----

1-conductor female plug; angled

	gray	769-101/022-000	200
---	------	-----------------	-----

2-conductor female plug

	gray	769-121	100
---	------	---------	-----

Mini-WSB Inline, plain; 1,700 WMB markers (5 mm)/reel; 5 ... 5.2 mm stretchable

	white	2009-145	1
---	-------	----------	---

Mini-WSB marking card; white; 10 strips with 10 markers/card; 5 mm wide markers

	plain	248-501	5
---	-------	---------	---

1-Conductor/1-Pin and 2-Pin Diode Carrier Terminal Block X-COM®-SYSTEM 4 mm²; 769 Series

Technical Data	
0.08 ... 4 mm ²	28 ... 12 AWG
U _N 250 V; U _{RM} 1000 V	
1N4007 – 0.5 A continuous current	
Terminal block width: 5 mm / 0.197 inch	
8 ... 9 mm / 0.31 ... 0.35 inch	

Technical Data	
U _N 250 V; U _{RM} 1000 V	
1N4007 – 0.5 A continuous current	
Terminal block width: 5 mm / 0.197 inch	

Note: 2-conductor female plugs cannot be used.

Please observe the application notes:
Insulation stop, page 382
Mini-WSB marking system, page 641

Approvals and corresponding ratings, visit www.wago.com

Accessories; 769 Series
Appropriate marking systems:
Mini-WSB/Mini-WSB Inline

Mini-WSB Inline, plain; 1,700 WMB markers (5 mm)/reel; 5 ... 5.2 mm stretchable

	white	2009-145	1
--	-------	----------	---

Mini-WSB marking card; white; 10 strips with 10 markers/card; 5 mm wide markers

	plain	248-501	5
--	-------	---------	---

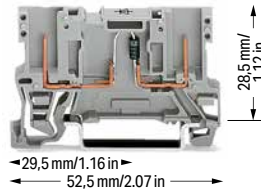
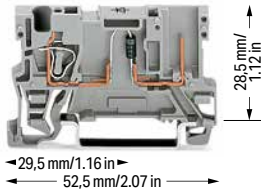

769-238/281-411

769-238/281-410

769-228/281-411

769-228/281-410

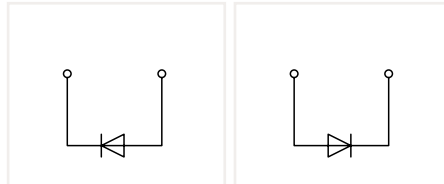
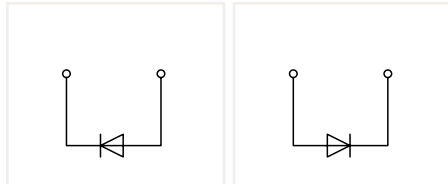

1-conductor/1-pin diode carrier terminal block		
	Item No.	Pack. Unit
○ Anode, right side	769-238/281-411	100
○ Anode, left side	769-238/281-410	100

2-pin diode carrier block		
	Item No.	Pack. Unit
○ Anode, right side	769-228/281-411	100
○ Anode, left side	769-228/281-410	100

Accessories; item-specific
End and intermediate plate; 1.1 mm thick

	orange	769-308	100 (25)
	gray	769-307	100 (25)

Accessories; item-specific
End and intermediate plate; 1.1 mm thick

	orange	769-306	100 (25)
	gray	769-305	100 (25)

Insulation stop; 0.08 ... 0.2 mm² "s" (0.14 mm² "f-st"); 5 pcs/strip

	white	769-470	200 (25)
--	-------	---------	----------

Insulation stop; 0.25 ... 0.5 mm²; 5 pcs/strip

	light gray	769-471	200 (25)
--	------------	---------	----------

Insulation stop; 0.75 ... 1 mm²; 5 pcs/strip

	dark gray	769-472	200 (25)
--	-----------	---------	----------

Protective warning marker; with black high-voltage symbol; for 5 terminal blocks

	yellow	280-415	100 (25)
--	--------	---------	----------

Test plug; with 500 mm cable; 2 mm Ø; max. 42 V

	red	210-136	50
--	-----	---------	----

Accessories; 769 Series
Appropriate marking systems: Mini-WSB/Mini-WSB Inline

Coding pin; for coding female plugs

	orange	769-435	100 (25)
--	--------	---------	----------

1-connector female plug; straight

	gray	769-101	200
--	------	---------	-----

1-conductor female plug; angled

	gray	769-101/022-000	200
--	------	-----------------	-----

7

1-Conductor/1-Pin and 2-Din Diode Carrier Terminal Block X-COM®-SYSTEM; with Two Jumper Positions

4 mm²; 769 Series

Technical Data	
0.08 ... 4 mm ²	28 ... 12 AWG
U _N 250 V; U _{RM} 1000 V	
1N4007 – 0.5 A continuous current	
Terminal block width: 5 mm / 0.197 inch	
 8 ... 9 mm / 0.31 ... 0.35 inch	

Technical Data	
U _N 250 V; U _{RM} 1000 V	
1N4007 – 0.5 A continuous current	
Terminal block width: 5 mm / 0.197 inch	

Please observe the application notes:
 Insulation stop, page 382
 Jumpers, from page 384
 Testing accessories, from page 344
 Mini-WSB marking system, page 641

Approvals and corresponding ratings, visit www.wago.com

Accessories; 769 Series
 Appropriate marking systems:
 Mini-WSB/Mini-WSB Inline

Coding pin; for coding female plugs			
	orange	769-435	100 (25)

Adjacent jumper; insulated; I _N = I _N terminal block			
	gray	280-402	200 (25)

Alternate jumper; insulated; I _N = I _N terminal block			
	gray	280-409	100 (25)

Staggered jumper; insulated; 5 mm wide; I _N 24 A			
	1 to 2	780-452	100 (25)
	1 to 3	780-453	100 (25)
	1 to 4	780-454	100 (25)
	1 to 5	780-455	50 (25)
	1 to 6	780-456	50 (25)
	1 to 7	780-457	50 (25)
	1 to 8	780-458	50 (25)

Push-in type wire jumper; insulated; 0.75 mm ² conductor cross section; I _N 9 A			
	L = 60 mm	249-125	100 (10)
	L = 110 mm	249-126	100 (10)
	L = 250 mm	249-127	100 (10)

Test plug module; snaps together; 5 mm wide			
	gray	280-418	100 (25)

Spacer module; snaps together; 5 mm wide			
	gray	280-419	100 (25)

1-connector female plug; straight			
	gray	769-101	200

1-conductor female plug; angled			
	gray	769-101/022-000	200

2-conductor female plug			
	gray	769-121	100

Mini-WSB Inline, plain; 1,700 WMB markers (5 mm)/reel; 5 ... 5.2 mm stretchable			
	white	2009-145	1

Mini-WSB marking card; white; 10 strips with 10 markers/card; 5 mm wide markers			
	plain	248-501	5

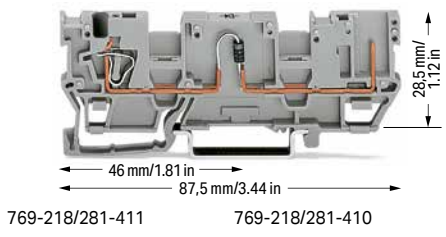

769-218/281-411 769-218/281-410

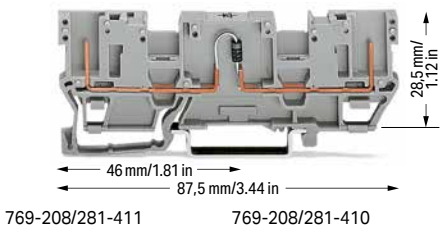

769-208/281-411 769-208/281-410

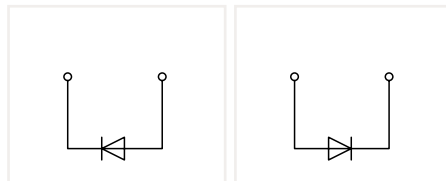

1-conductor/1-pin diode carrier terminal block; with two jumper positions

	Item No.	Pack. Unit
○ Anode, right side	769-218/281-411	50
○ Anode, left side	769-218/281-410	50

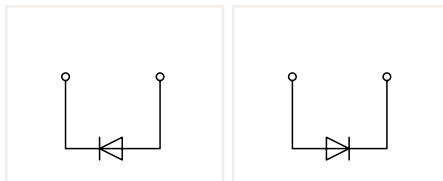



2-pin diode carrier terminal block; with two jumper positions

	Item No.	Pack. Unit
○ Anode, right side	769-208/281-411	50
○ Anode, left side	769-208/281-410	50

Accessories; item-specific

End and intermediate plate; 1.1 mm thick			
	orange	769-312	100 (25)
	gray	769-311	100 (25)

Separator; oversized; 1.1 mm thick			
	orange	769-314	100 (25)

Insulation stop; 0.08 ... 0.2 mm ² "s" (0.14 mm ² "f-st"); 5 pcs/strip			
	white	769-470	200 (25)

Insulation stop; 0.25 ... 0.5 mm ² ; 5 pcs/strip			
	light gray	769-471	200 (25)

Insulation stop; 0.75 ... 1 mm ² ; 5 pcs/strip			
	dark gray	769-472	200 (25)

Protective warning marker; with black high-voltage symbol; for 5 terminal blocks			
	yellow	280-415	100 (25)

Test plug; with 500 mm cable; 2 mm Ø; max. 42 V			
	red	210-136	50

1-Conductor/1-Pin and 2-Pin LED Carrier Terminal Block X-COM®-SYSTEM 4 mm²; 769 Series

Technical Data	
0.08 ... 4 mm ²	28 ... 12 AWG
24 VDC	
I _F 0.025 A max.	
Terminal block width: 5 mm / 0.197 inch	
8 ... 9 mm / 0.31 ... 0.35 inch	

Technical Data	
24 VDC	
I _F 0.025 A max.	
Terminal block width: 5 mm / 0.197 inch	

Note: 2-conductor female plugs cannot be used.

Please observe the application notes:
Insulation stop, page 382
Mini-WSB marking system, page 641

Approvals and corresponding ratings,
visit www.wago.com

Accessories; 769 Series

Appropriate marking systems:
Mini-WSB/Mini-WSB Inline

Mini-WSB Inline, plain; 1,700 WMB markers (5 mm)/reel; 5 ... 5.2 mm stretchable

	white	2009-145	1
--	-------	----------	---

Mini-WSB marking card; white; 10 strips with 10 markers/
card; 5 mm wide markers

	plain	248-501	5
--	-------	---------	---

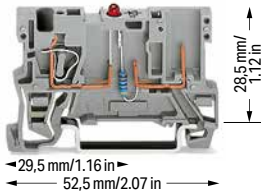

769-239/281-413

769-239/281-434

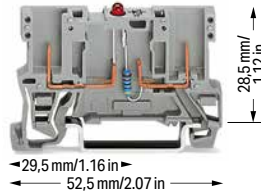

769-229/281-413

769-229/281-434

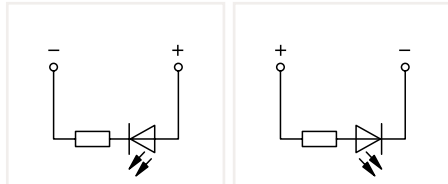

1-cond./1-pin LED carrier block

	Item No.	Pack. Unit
○ Anode, right side	769-239/281-413	100
○ Anode, left side	769-239/281-434	100

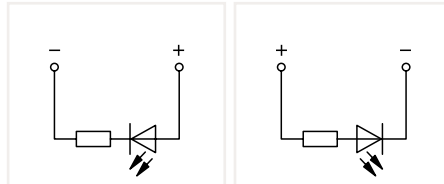

2-pin LED carrier block

	Item No.	Pack. Unit
○ Anode, right side	769-229/281-413	100
○ Anode, left side	769-229/281-434	100

Accessories; item-specific

End and intermediate plate; 1.1 mm thick

	orange	769-308	100 (25)
	gray	769-307	100 (25)

Accessories; item-specific

End and intermediate plate; 1.1 mm thick

	orange	769-306	100 (25)
	gray	769-305	100 (25)

Insulation stop; 0.08 ... 0.2 mm² "s" (0.14 mm² "f-st"); 5 pcs/strip

	white	769-470	200 (25)
--	-------	---------	----------

Insulation stop; 0.25 ... 0.5 mm²; 5 pcs/strip

	light gray	769-471	200 (25)
--	------------	---------	----------

Insulation stop; 0.75 ... 1 mm²; 5 pcs/strip

	dark gray	769-472	200 (25)
--	-----------	---------	----------

Protective warning marker; with black high-voltage symbol; for 5 terminal blocks

	yellow	280-415	100 (25)
--	--------	---------	----------

Test plug; with 500 mm cable; 2 mm Ø; max. 42 V

	red	210-136	50
--	-----	---------	----

Accessories; 769 Series

Appropriate marking systems: Mini-WSB/Mini-WSB Inline

Coding pin; for coding female plugs

	orange	769-435	100 (25)
--	--------	---------	----------

1-connector female plug; straight

	gray	769-101	200
--	------	---------	-----

1-conductor female plug; angled

	gray	769-101/022-000	200
--	------	-----------------	-----

7

1-Conductor/1-Pin and 2-Pin LED Carrier Terminal Block X-COM®-SYSTEM; with Two Jumper Positions

4 mm²; 769 Series

Technical Data	
0.08 ... 4 mm ²	28 ... 12 AWG
24 VDC	
I _F 0.025 A max.	
Terminal block width: 5 mm / 0.197 inch	
 8 ... 9 mm / 0.31 ... 0.35 inch	

Technical Data	
24 VDC	
I _F 0.025 A max.	
Terminal block width: 5 mm / 0.197 inch	

Please observe the application notes:
 Insulation stop, page 382
 Jumpers, from page 384
 Testing accessories, from page 344
 Mini-WSB marking system, page 641

Approvals and corresponding ratings, visit www.wago.com

Accessories; 769 Series
 Appropriate marking systems:
 Mini-WSB/Mini-WSB Inline

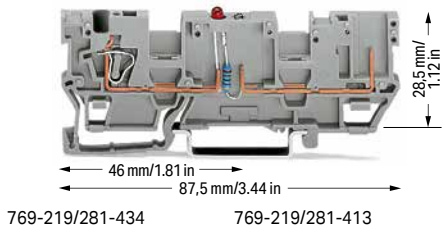

769-219/281-434 769-219/281-413

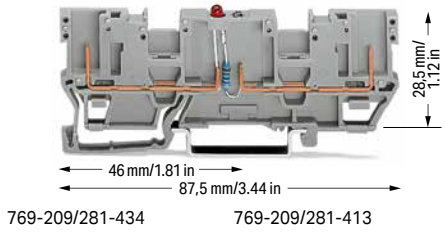

769-209/281-434 769-209/281-413

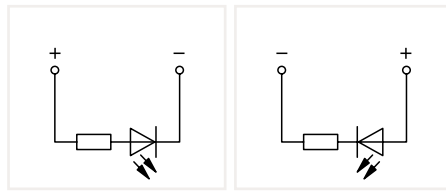

1-conductor/1-pin LED carrier terminal block; with two jumper positions

	Item No.	Pack. Unit
○ Anode, left side	769-219/281-434	50
○ Anode, right side	769-219/281-413	50

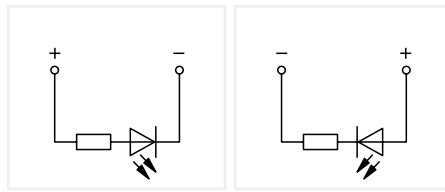



2-pin LED carrier terminal block; with two jumper positions

	Item No.	Pack. Unit
○ Anode, left side	769-209/281-434	50
○ Anode, right side	769-209/281-413	50

Accessories; item-specific

End and intermediate plate; 1.1 mm thick

	orange	769-312	100 (25)
	gray	769-311	100 (25)

Separator; oversized; 1.1 mm thick

	orange	769-314	100 (25)
---	--------	---------	----------

Insulation stop; 0.08 ... 0.2 mm² "s" (0.14 mm² "f-st"); 5 pcs/strip

	white	769-470	200 (25)
---	-------	---------	----------

Insulation stop; 0.25 ... 0.5 mm²; 5 pcs/strip

	light gray	769-471	200 (25)
---	------------	---------	----------

Insulation stop; 0.75 ... 1 mm²; 5 pcs/strip

	dark gray	769-472	200 (25)
---	-----------	---------	----------

Protective warning marker; with black high-voltage symbol; for 5 terminal blocks



	yellow	280-415	100 (25)
---	--------	---------	----------

Test plug; with 500 mm cable; 2 mm Ø; max. 42 V

	red	210-136	50
---	-----	---------	----

Accessories; item-specific

End and intermediate plate; 1.1 mm thick

	orange	769-310	100 (25)
	gray	769-309	100 (25)

Separator; oversized; 1.1 mm thick

	orange	769-313	100 (25)
---	--------	---------	----------

Coding pin; for coding female plugs

	orange	769-435	100 (25)
---	--------	---------	----------

Adjacent jumper; insulated; I_N = I_N terminal block

	gray	280-402	200 (25)
---	------	---------	----------

Alternate jumper; insulated; I_N = I_N terminal block

	gray	280-409	100 (25)
---	------	---------	----------

Staggered jumper; insulated; 5 mm wide; I_N 24 A

	1 to 2	780-452	100 (25)
	1 to 3	780-453	100 (25)
	1 to 4	780-454	100 (25)
	1 to 5	780-455	50 (25)
	1 to 6	780-456	50 (25)
	1 to 7	780-457	50 (25)
	1 to 8	780-458	50 (25)

Push-in type wire jumper; insulated; 0.75 mm² conductor cross section; I_N 9 A

	L = 60 mm	249-125	100 (10)
	L = 110 mm	249-126	100 (10)
	L = 250 mm	249-127	100 (10)

Test plug module; snaps together; 5 mm wide

	gray	280-418	100 (25)
---	------	---------	----------

Spacer module; snaps together; 5 mm wide

	gray	280-419	100 (25)
---	------	---------	----------

1-connector female plug; straight

	gray	769-101	200
---	------	---------	-----

1-conductor female plug; angled

	gray	769-101/022-000	200
---	------	-----------------	-----

2-conductor female plug

	gray	769-121	100
---	------	---------	-----

Mini-WSB Inline, plain; 1,700 WMB markers (5 mm)/reel; 5 ... 5.2 mm stretchable

	white	2009-145	1
---	-------	----------	---

Mini-WSB marking card; white; 10 strips with 10 markers/card; 5 mm wide markers

	plain	248-501	5
---	-------	---------	---

1-Conductor/1-Pin and 2-Pin Carrier Terminal Blocks and 1-Conductor Female Plugs X-COM®-SYSTEM Assembly Types



1-conductor female plug
Disconnect carrier terminal blocks cannot be commoned.



1-conductor female plug
Disconnect carrier terminal blocks cannot be commoned.



1-conductor female plug
Diode carrier terminal blocks cannot be commoned.

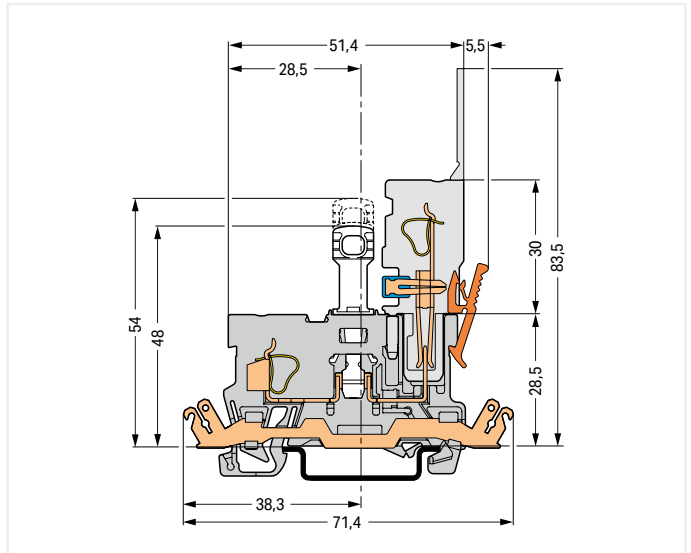

Disconnect carrier terminal block; with shield contact



1-conductor female plug
LED carrier terminal blocks cannot be commoned.

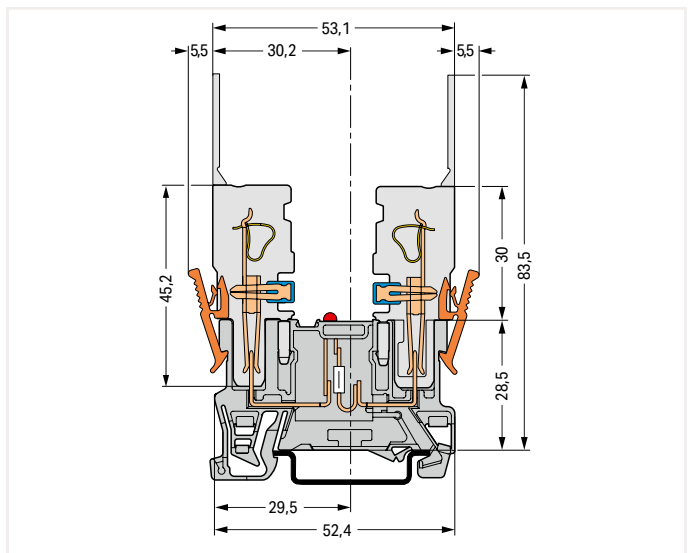

LED carrier terminal block

7

1-Conductor/1-Pin and 2-Pin Carrier Terminal Blocks X-COM®-SYSTEM; with Two Jumper Positions and 1-/2-Conductor Female Plugs Assembly Types

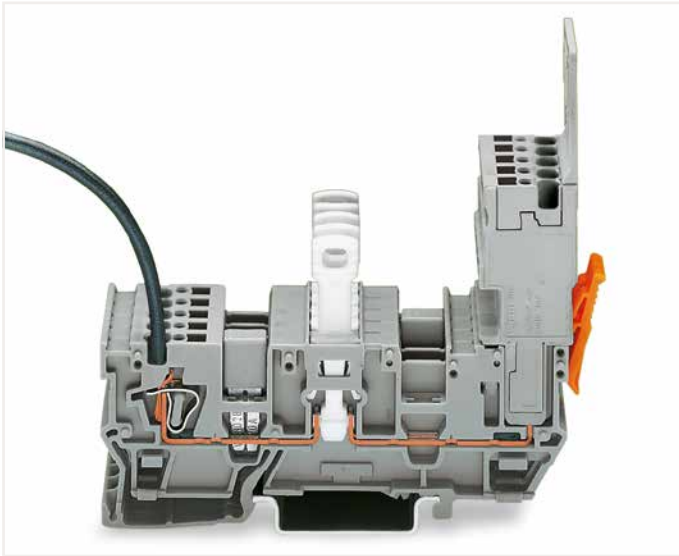

1-conductor female plug
Disconnect carrier terminal blocks can be commoned via 280 and 780 Series Jumpers and tested using a test plug adapter (280-4..).



2-conductor female plug
Disconnect carrier terminal blocks can be commoned via 280 and 780 Series Jumpers.

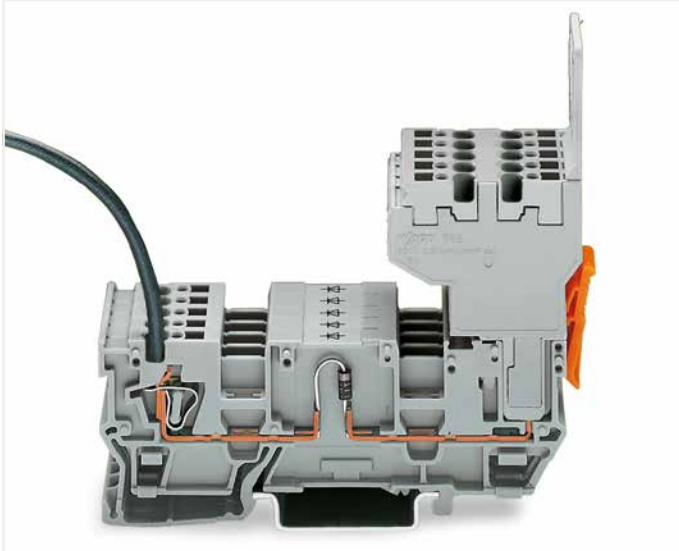

2-conductor female plug
Diode carrier terminal blocks can be commoned via 280 and 780 Series Jumpers and tested using a test plug adapter (280-4..).

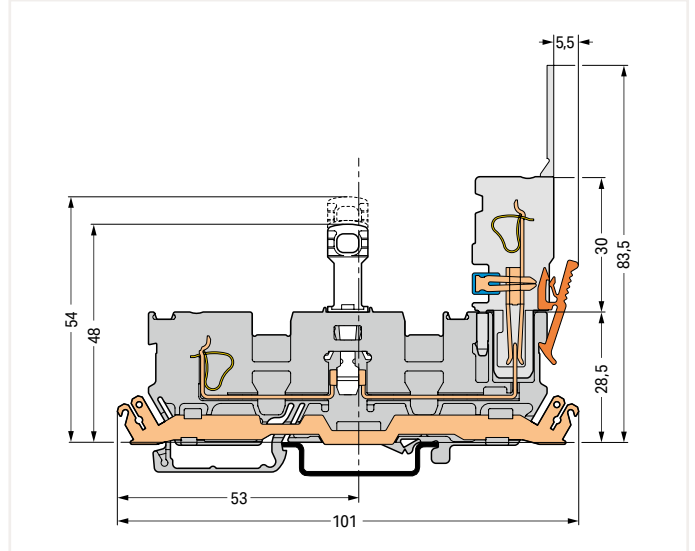

Disconnect carrier terminal block; with shield contact



2-conductor and 1-conductor female plugs (may be reversed)
LED carrier terminal blocks can be commoned via 280 and 780 Series Jumpers and tested using a test plug adapter (280-4..).

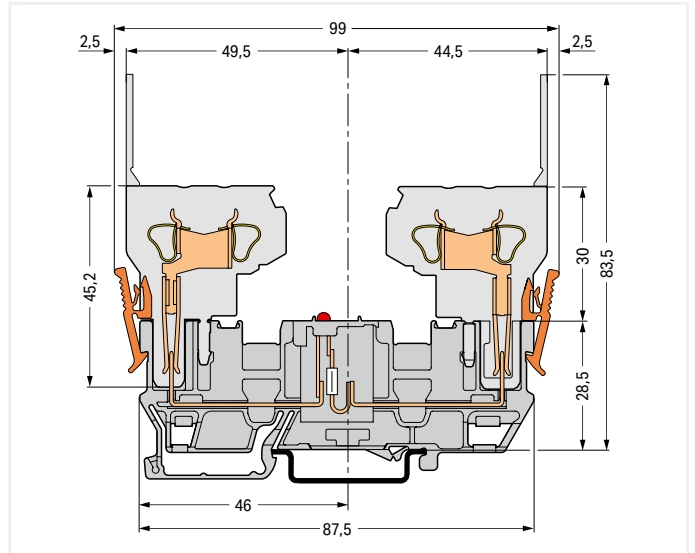

LED carrier terminal block

1-Conductor/1-Conductor Pin Disconnect Carrier Terminal Block X-COM®-SYSTEM; with Two Jumper Positions

4 mm²; 769 Series

Technical Data

0.08 ... 4 mm² | 28 ... 12 AWG

400 V/6 kV/3 ①

I_N 16 A

Terminal block width: 5 mm / 0.197 inch

8 ... 9 mm / 0.31 ... 0.35 inch

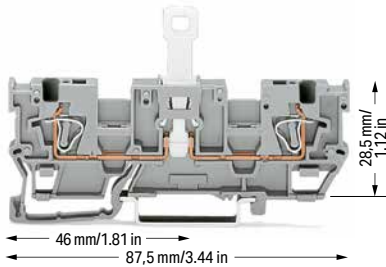

1-conductor/1-conductor pin disconnect carrier terminal block; with two jumper positions

Color	Item No.	Pack. Unit
○ gray	769-242	50

1-conductor/1-conductor disconnect carrier terminal block; with shield contact

○ gray	769-243 ①	50
--------	-----------	----

Accessories; 769 Series

Appropriate marking systems:
Mini-WSB/Mini-WSB Inline

End and intermediate plate; 1.1 mm thick

	orange	769-318	100 (25)
	gray	769-317	100 (25)

Separator plate; oversized; 1.1 mm thick

	orange	769-319	100 (25)
--	--------	---------	----------

Insulation stop; 0.08 ... 0.2 mm² "s" (0.14 mm² "f-st"); 5 pcs/strip

	white	769-470	200 (25)
--	-------	---------	----------

Insulation stop; 0.25 ... 0.5 mm²; 5 pcs/strip

	light gray	769-471	200 (25)
--	------------	---------	----------

Insulation stop; 0.75 ... 1 mm²; 5 pcs/strip

	dark gray	769-472	200 (25)
--	-----------	---------	----------

Protective warning marker; with black high-voltage symbol; for 5 terminal blocks

	yellow	280-415	100 (25)
--	--------	---------	----------

Adjacent jumper; insulated; I_N = I_N terminal block

	gray	280-402	200 (25)
--	------	---------	----------

Alternate jumper; insulated; I_N = I_N terminal block

	gray	280-409	100 (25)
--	------	---------	----------

- ① 400 V = rated voltage
6 kV = rated impulse voltage
3 = pollution degree
250 V/4 kV/3 = Nominal voltage with shield contact (see Section 15)

Please observe the application notes:
Insulation stop, page 382
Jumpers, from page 384
Testing accessories, from page 344
Mini-WSB marking system, page 641

Approvals and corresponding ratings,
visit www.wago.com

Accessories; 769 Series

Appropriate marking systems:
Mini-WSB/Mini-WSB Inline

Staggered jumper; insulated; 5 mm wide; I_N 24 A

	1 to 2	780-452	100 (25)
	1 to 3	780-453	100 (25)
	1 to 4	780-454	100 (25)
	1 to 5	780-455	50 (25)
	1 to 6	780-456	50 (25)
	1 to 7	780-457	50 (25)
	1 to 8	780-458	50 (25)

Push-in type wire jumper; insulated; 0.75 mm² conductor cross section; I_N 9 A

	L = 60 mm	249-125	100 (10)
	L = 110 mm	249-126	100 (10)
	L = 250 mm	249-127	100 (10)

Test plug module; snaps together; 5 mm wide

	gray	280-418	100 (25)
--	------	---------	----------

Spacer module; snaps together; 5 mm wide

	gray	280-419	100 (25)
--	------	---------	----------

Test plug; with 500 mm cable; 2 mm Ø; max. 42 V

	red	210-136	50
--	-----	---------	----

Test plug adapter; 5 mm wide; for 1.5 ... 4 mm² terminal blocks

	gray	280-404	100 (25)
--	------	---------	----------

Disconnect lock; for disconnect tab used on disconnect terminal blocks (280/281 and 769 Series)

	red	709-170	200 (25)
--	-----	---------	----------

Mini-WSB Inline, plain; 1,700 WMB markers (5 mm)/reel; 5 ... 5.2 mm stretchable

	white	2009-145	1
--	-------	----------	---

Mini-WSB marking card; white; 10 strips with 10 markers/card; 5 mm wide markers

	plain	248-501	5
--	-------	---------	---

7

1-Conductor/1-Conductor Pin Disconnect Carrier Terminal Blocks X-COM®-SYSTEM; with Two Jumper Positions Assembly Types

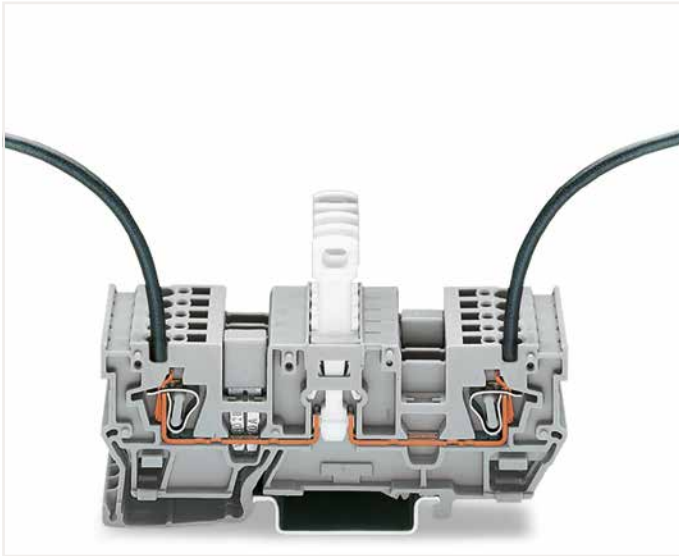

Carrier terminal blocks can be commoned via 280 and 780 Series Jumpers and tested using a test plug adapter (280-4..).

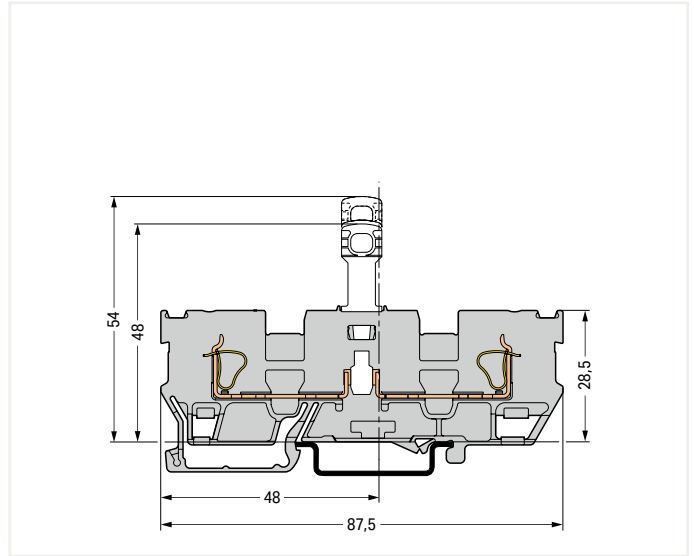

Disconnect carrier terminal block

1-Conductor/1-Pin Carrier Terminal Block and Carrier Terminal Block X-COM®-SYSTEM; for Pluggable Module (Fuses, Relays, Optocouplers, etc.) 4 mm²; 769 Series

Technical Data

0.08 ... 4 mm ²	28 ... 12 AWG
400 V/6 kV/3 ①	300 V, 20 A ②
I _N 16 A ②	300 V, 20 A ②

Terminal block width: 5 mm / 0.197 inch

8 ... 9 mm / 0.31 ... 0.35 inch

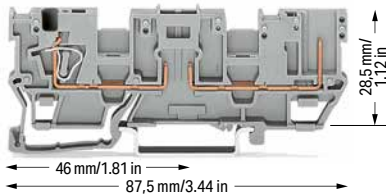

1-conductor/1-pin carrier terminal block; with two jumper positions; gray

	Item No.	Pack. Unit
○ 2-pole	769-181	50

Technical Data

0.08 ... 4 mm ²	28 ... 12 AWG
400 V/6 kV/3 ①	300 V, 20 A ②
I _N 16 A ②	300 V, 20 A ②

8 ... 9 mm / 0.31 ... 0.35 inch

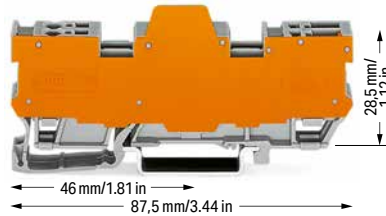

1-conductor/1-pin terminal block for pluggable modules; with two jumper positions; with orange separator plate; gray

	Item No.	Pack. Unit
○ 4-pole; 11.1 mm wide	769-182/769-314	10
○ 6-pole; 16.1 mm wide	769-183/769-314	5
○ 8-pole; 21.1 mm wide	769-184/769-314	5
○ 10-pole; 26.1 mm wide	769-185/769-314	5

① 400 V = rated voltage
6 kV = rated impulse voltage
3 = pollution degree
(see Section 15)

② 16 A, 85°C upper temperature limit, current-carrying capacity curves upon request

Note: 2-conductor female plugs cannot be used.

Please observe the application notes:
Insulation stop, page 382
Jumpers, from page 384
Testing accessories, from page 344
Mini-WSB marking system, page 641

Approvals and corresponding ratings, visit www.wago.com

Accessories; 769 Series

Appropriate marking systems:
Mini-WSB/Mini-WSB Inline

Test plug adapter; 5 mm wide; for 1.5 ... 4 mm² terminal blocks

	gray	280-404	100 (25)
--	------	---------	----------

1-connector female plug; straight

	gray	769-101	200
--	------	---------	-----

Mini-WSB Inline, plain; 1,700 WMB markers (5 mm)/reel; 5 ... 5.2 mm stretchable

	white	2009-145	1
--	-------	----------	---

Mini-WSB marking card; white; 10 strips with 10 markers/card; 5 mm wide markers

	plain	248-501	5
--	-------	---------	---

Accessories; 769 Series

Appropriate marking systems: Mini-WSB/Mini-WSB Inline

End and intermediate plate; 1.1 mm thick

	orange	769-312	100 (25)
	gray	769-311	100 (25)

Separator; oversized; 1.1 mm thick

	orange	769-314	100 (25)
--	--------	---------	----------

Insulation stop; 0.08 ... 0.2 mm² "s" (0.14 mm² "f-st"); 5 pcs/strip

	white	769-470	200 (25)
--	-------	---------	----------

Insulation stop; 0.25 ... 0.5 mm²; 5 pcs/strip

	light gray	769-471	200 (25)
--	------------	---------	----------

Insulation stop; 0.75 ... 1 mm²; 5 pcs/strip

	dark gray	769-472	200 (25)
--	-----------	---------	----------

Protective warning marker; with black high-voltage symbol; for 5 terminal blocks

	yellow	280-415	100 (25)
--	--------	---------	----------

Coding pin; for coding female plugs

	orange	769-435	100 (25)
--	--------	---------	----------

Adjacent jumper; insulated; I_N = I_N terminal block

	gray	280-402	200 (25)
--	------	---------	----------

Alternate jumper; insulated; I_N = I_N terminal block

	gray	280-409	100 (25)
--	------	---------	----------

Staggered jumper; insulated; 5 mm wide; I_N 24 A

	1 to 2	780-452	100 (25)
	1 to 3	780-453	100 (25)
	1 to 4	780-454	100 (25)
	1 to 5	780-455	50 (25)
	1 to 6	780-456	50 (25)
	1 to 7	780-457	50 (25)
	1 to 8	780-458	50 (25)

Push-in type wire jumper; insulated; 0.75 mm² conductor cross section; I_N 9 A

	L = 60 mm	249-125	100 (10)
	L = 110 mm	249-126	100 (10)
	L = 250 mm	249-127	100 (10)

Test plug module; snaps together; 5 mm wide

	gray	280-418	100 (25)
--	------	---------	----------

Spacer module; snaps together; 5 mm wide

	gray	280-419	100 (25)
--	------	---------	----------

Test plug; with 500 mm cable; 2 mm Ø; max. 42 V

	red	210-136	50
--	-----	---------	----

7

1-Conductor Female Plugs and Selection of Pluggable Modules X-COM®-SYSTEM Assembly Types

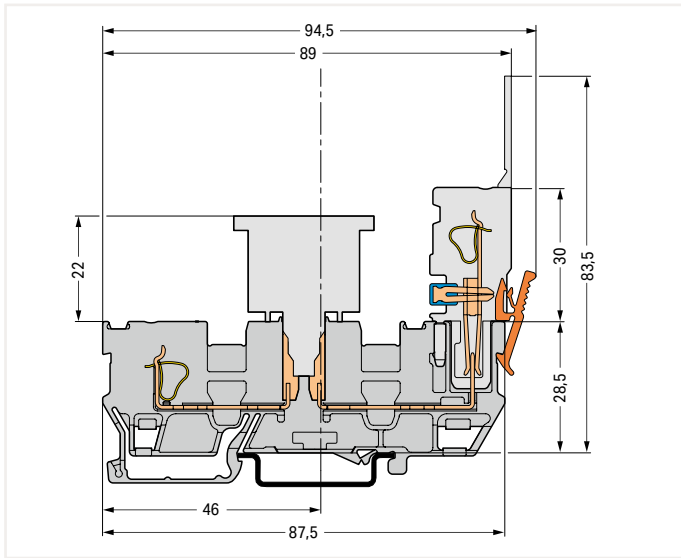

Carrier terminal block

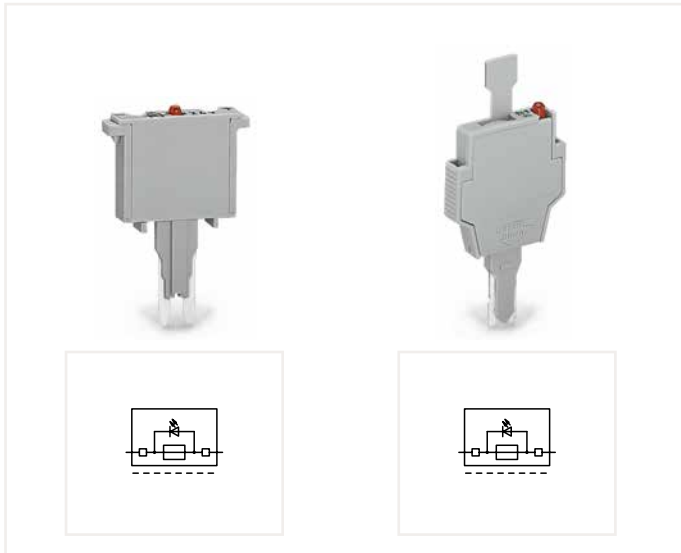

Selection of pluggable modules

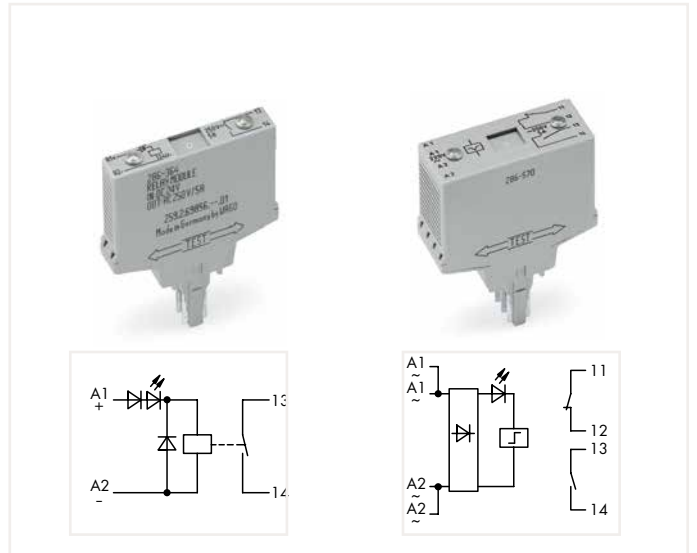

Selection of pluggable modules

2-Pin Carrier Terminal Block and Carrier Terminal Block X-COM®-SYSTEM; for Pluggable Module (Fuses, Relays, Optocouplers, etc.) 769 Series

Technical Data

400 V/6 kV/3 ①	300 V, 20 A ②
I _N 16 A ②	300 V, 20 A ②
Terminal block width: 5 mm / 0.197 inch	

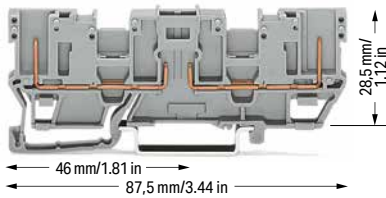

2-pin carrier terminal block; with two jumper positions; gray

	Item No.	Pack. Unit
○ 2-pole	769-161	50

Technical Data

400 V/6 kV/3 ①	300 V, 20 A ②
I _N 16 A ②	300 V, 20 A ②

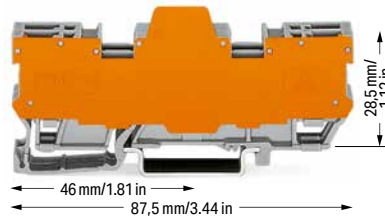

2-pin terminal block for pluggable modules; with two jumper positions; with orange separator plate; gray

	Item No.	Pack. Unit
○ 4-pole; 11.1 mm wide	769-162/769-313	10
○ 6-pole; 16.1 mm wide	769-163/769-313	5
○ 8-pole; 21.1 mm wide	769-164/769-313	5
○ 10-pole; 26.1 mm wide	769-165/769-313	5

① 400 V = rated voltage
6 kV = rated impulse voltage
3 = pollution degree
(see Section 15)

② 16 A, 85°C upper temperature limit, current-carrying capacity curves upon request

Note: 2-conductor female plugs cannot be used.

Please observe the application notes: Jumpers, from page 384
Mini-WSB marking system, page 641

Approvals and corresponding ratings, visit www.wago.com

7

Accessories; 769 Series

Appropriate marking systems: Mini-WSB/Mini-WSB Inline

End and intermediate plate; 1.1 mm thick

	orange	769-310	100 (25)
	gray	769-309	100 (25)

Separator; oversized; 1.1 mm thick

	orange	769-313	100 (25)
--	--------	---------	----------

Coding pin; for coding female plugs

	orange	769-435	100 (25)
--	--------	---------	----------

Adjacent jumper; insulated; I_N = I_N terminal block

	gray	280-402	200 (25)
--	------	---------	----------

Alternate jumper; insulated; I_N = I_N terminal block

	gray	280-409	100 (25)
--	------	---------	----------

Staggered jumper; insulated; 5 mm wide; I_N 24 A

	1 to 2	780-452	100 (25)
	1 to 3	780-453	100 (25)
	1 to 4	780-454	100 (25)
	1 to 5	780-455	50 (25)
	1 to 6	780-456	50 (25)
	1 to 7	780-457	50 (25)
	1 to 8	780-458	50 (25)

Push-in type wire jumper; insulated; 0.75 mm² conductor cross section; I_N 9 A

	L = 60 mm	249-125	100 (10)
	L = 110 mm	249-126	100 (10)
	L = 250 mm	249-127	100 (10)

1-conductor female plug; straight

	gray	769-101	200
--	------	---------	-----

1-conductor female plug; angled

	gray	769-101/022-000	200
--	------	-----------------	-----

Mini-WSB Inline, plain; 1,700 WMB markers (5 mm)/reel; 5 ... 5.2 mm stretchable

	white	2009-145	1
--	-------	----------	---

Mini-WSB marking card; white; 10 strips with 10 markers/card; 5 mm wide markers

	plain	248-501	5
--	-------	---------	---

1-Conductor Female Plugs and Selection of Pluggable Modules X-COM®-SYSTEM Assembly Types

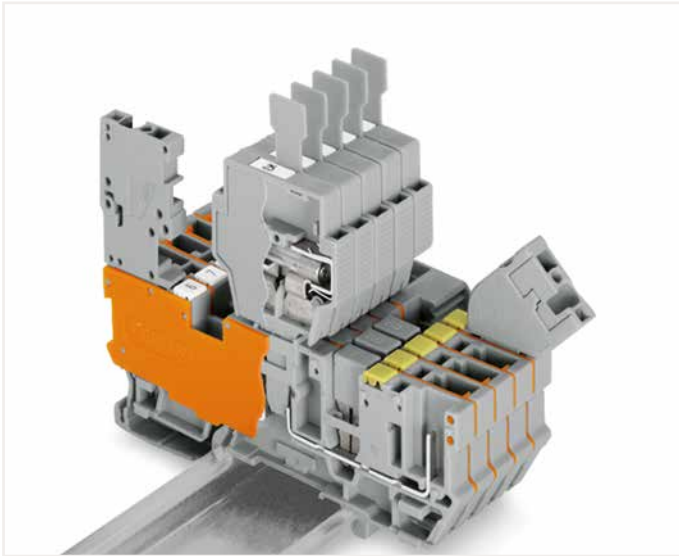

With 6 mm wide fuse plugs, only 1-pole female plugs can be used. Commoning is only possible using adjacent jumpers (280 Series) and push-in type wire jumpers.

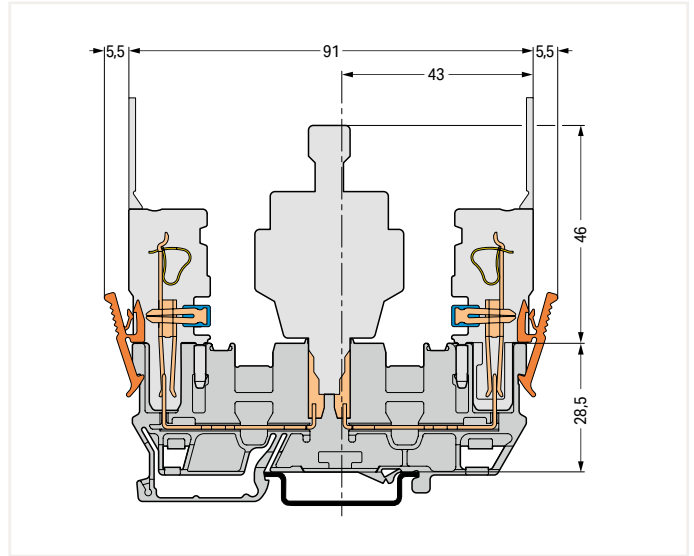

Carrier terminal block
For other dimensions, see carrier terminal block (769-151).



2-pin terminal block for pluggable modules; with orange separator plate

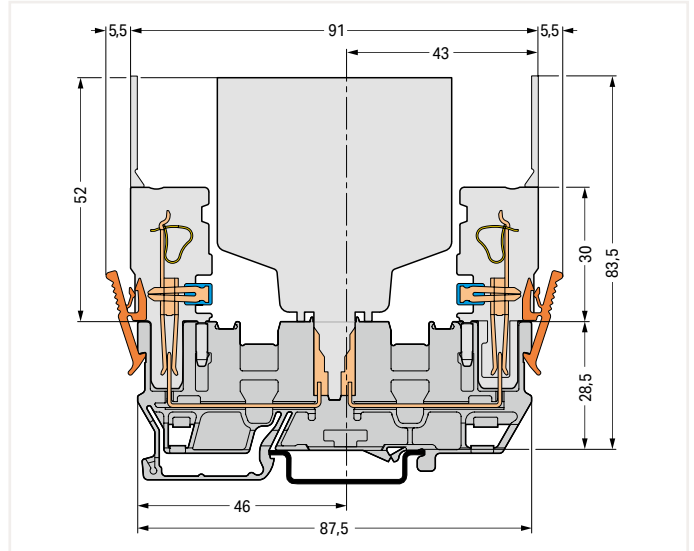

Carrier terminal block

7

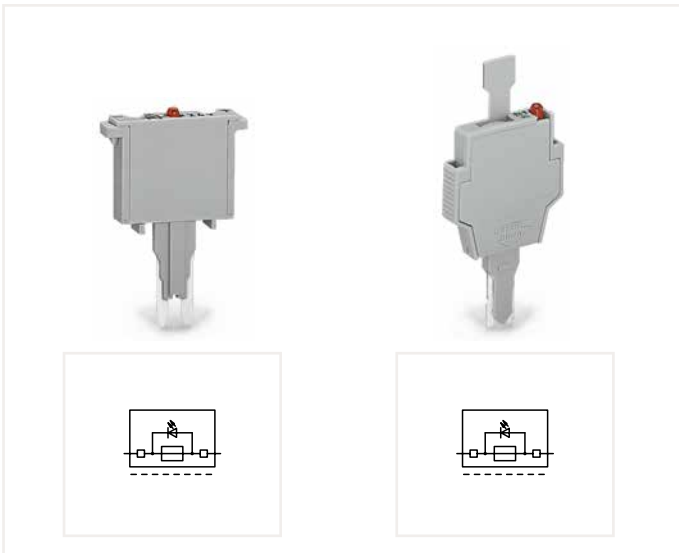

Selection of pluggable modules

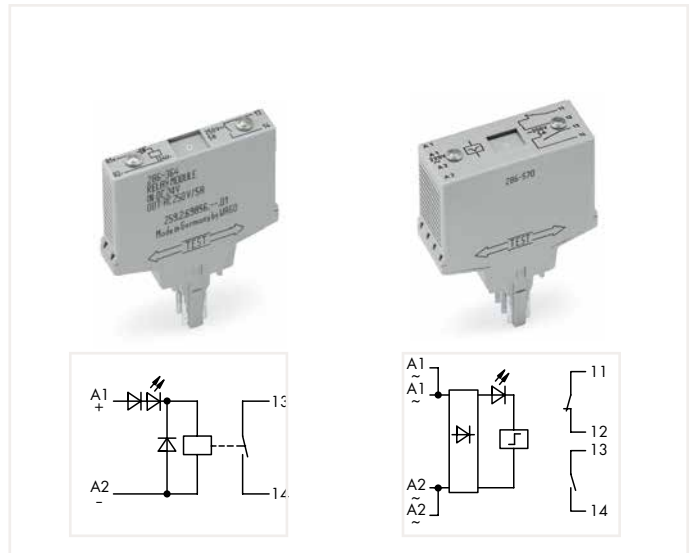

Selection of pluggable modules

1-Conductor/1-Conductor Carrier Terminal Block and Carrier Terminal Block X-COM®-SYSTEM; for Pluggable Module (Fuses, Relays, Optocouplers, etc.) 4 mm²; 769 Series

Technical Data

0.08 ... 4 mm ²	28 ... 12 AWG
400 V/6 kV/3 ①	300 V, 20 A ②
I _N 16 A ②	300 V, 20 A ②

Terminal block width: 5 mm / 0.197 inch

8 ... 9 mm / 0.31 ... 0.35 inch

Technical Data

0.08 ... 4 mm ²	28 ... 12 AWG
400 V/6 kV/3 ①	300 V, 20 A ②
I _N 16 A ②	300 V, 20 A ②

8 ... 9 mm / 0.31 ... 0.35 inch

- ① 400 V = rated voltage
6 kV = rated impulse voltage
3 = pollution degree
(see Section 15)

- ② 16 A, 85°C upper temperature limit, current-carrying capacity curves upon request

Please observe the application notes:
Insulation stop, page 382
Jumpers, from page 384
Testing accessories, from page 344
Mini-WSB marking system, page 641

Approvals and corresponding ratings, visit www.wago.com

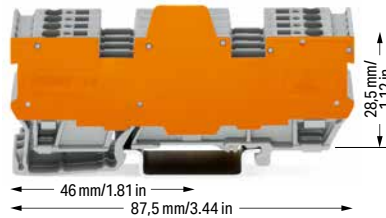
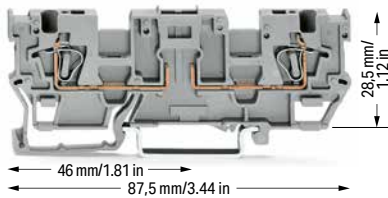

1-conductor/1-conductor carrier terminal block; with two jumper positions; gray

	Item No.	Pack. Unit
○ 2-pole	769-191	50

1-conductor/1-conductor terminal block for pluggable modules; with two jumper positions; with orange separator plate; gray

	Item No.	Pack. Unit
○ 4-pole; 11.1 mm wide	769-192/769-319	10
○ 6-pole; 16.1 mm wide	769-193/769-319	5
○ 8-pole; 21.1 mm wide	769-194/769-319	5
○ 10-pole; 26.1 mm wide	769-195/769-319	5

Accessories; 769 Series

Appropriate marking systems: Mini-WSB/Mini-WSB Inline

End and intermediate plate; 1.1 mm thick

	orange	769-318	100 (25)
	gray	769-317	100 (25)

Separator; oversized; 1.1 mm thick

	orange	769-319	100 (25)
--	--------	---------	----------

Insulation stop; 0.08 ... 0.2 mm² "s" (0.14 mm² "f-st"); 5 pcs/strip

	white	769-470	200 (25)
--	-------	---------	----------

Insulation stop; 0.25 ... 0.5 mm²; 5 pcs/strip

	light gray	769-471	200 (25)
--	------------	---------	----------

Insulation stop; 0.75 ... 1 mm²; 5 pcs/strip

	dark gray	769-472	200 (25)
--	-----------	---------	----------

Protective warning marker; with black high-voltage symbol; for 5 terminal blocks

	yellow	280-415	100 (25)
--	--------	---------	----------

Adjacent jumper; insulated; I_N = I_N terminal block

	gray	280-402	200 (25)
--	------	---------	----------

Alternate jumper; insulated; I_N = I_N terminal block

	gray	280-409	100 (25)
--	------	---------	----------

Staggered jumper; insulated; 5 mm wide; I_N 24 A

	1 to 2	780-452	100 (25)
	1 to 3	780-453	100 (25)
	1 to 4	780-454	100 (25)
	1 to 5	780-455	50 (25)
	1 to 6	780-456	50 (25)
	1 to 7	780-457	50 (25)
	1 to 8	780-458	50 (25)

Push-in type wire jumper; insulated; 0.75 mm² conductor cross section; I_N 9 A

	L = 60 mm	249-125	100 (10)
	L = 110 mm	249-126	100 (10)
	L = 250 mm	249-127	100 (10)

Test plug; with 500 mm cable; 2 mm Ø; max. 42 V

	red	210-136	50
--	-----	---------	----

Mini-WSB Inline, plain; 1,700 WMB markers (5 mm)/reel; 5 ... 5.2 mm stretchable

	white	2009-145	1
--	-------	----------	---

Mini-WSB marking card; white; 10 strips with 10 markers/card; 5 mm wide markers

	plain	248-501	6
--	-------	---------	---

7

Selection of Pluggable Modules Assembly Types

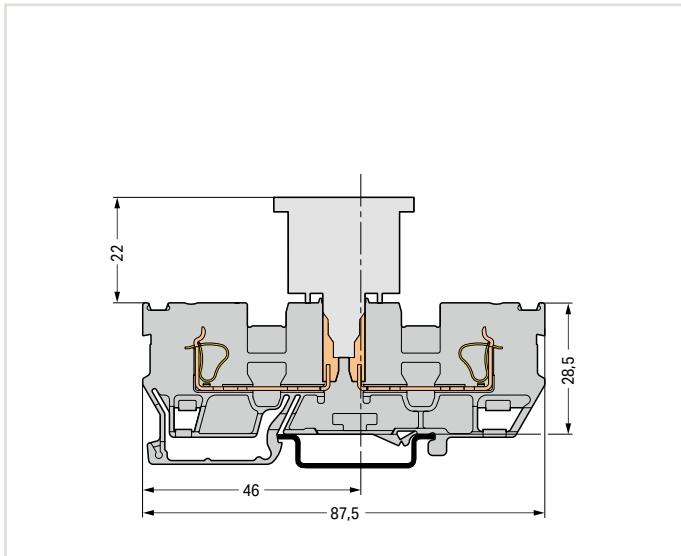

Carrier terminal block

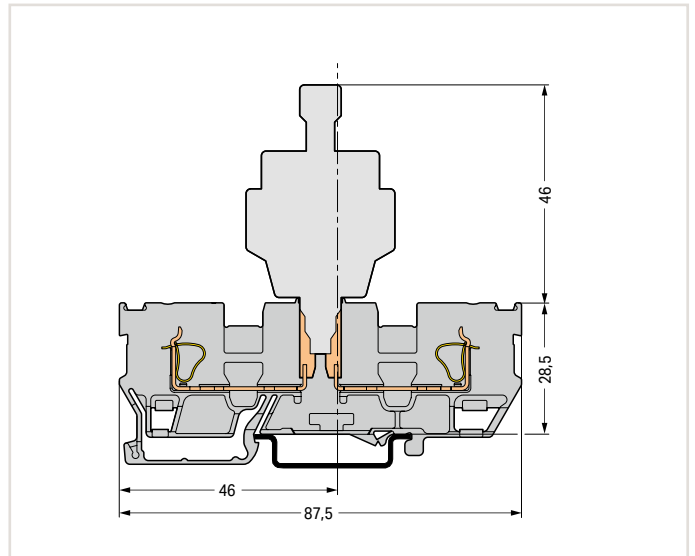

Carrier terminal block

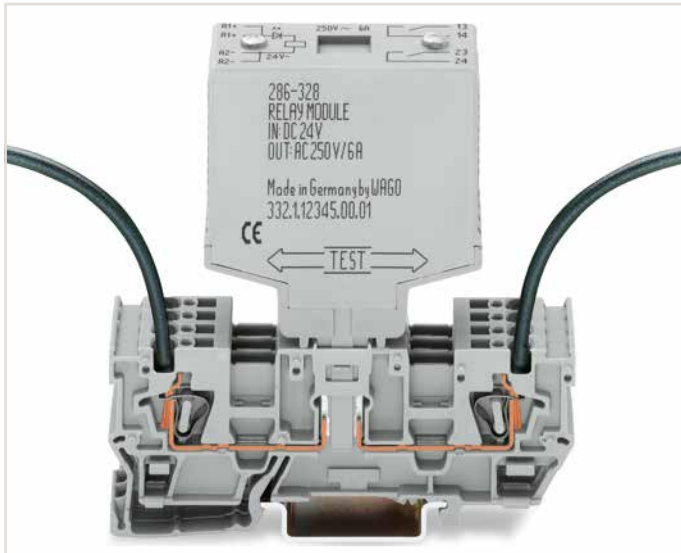

1-conductor/1-conductor carrier terminal block; with two jumper positions

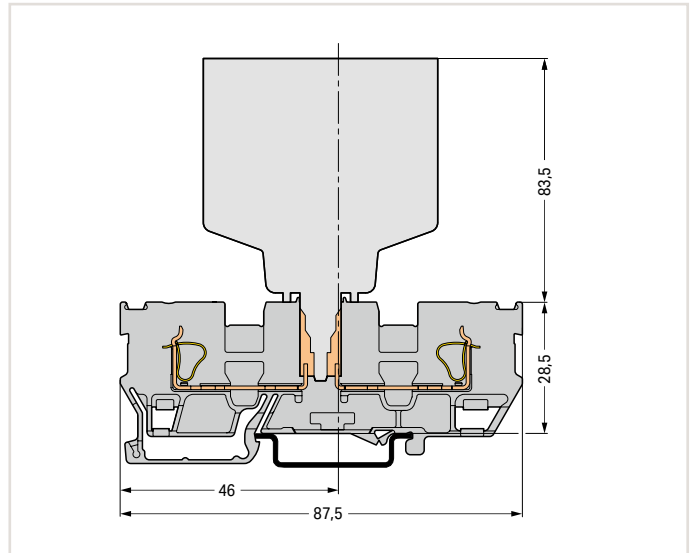

Carrier terminal block

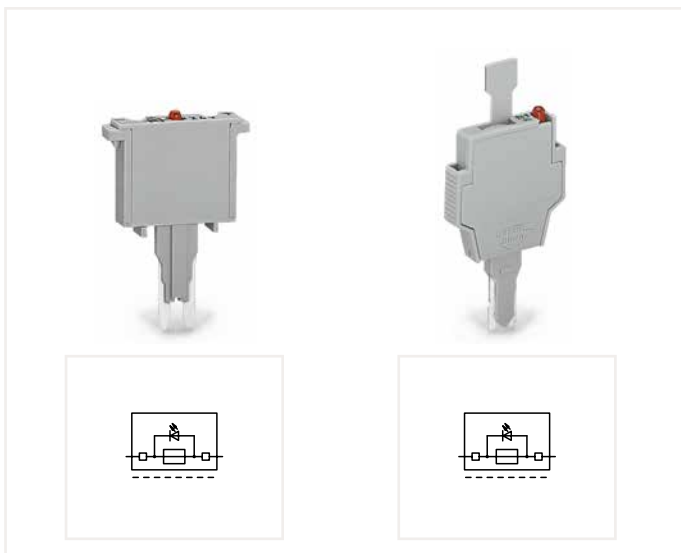

Selection of pluggable modules

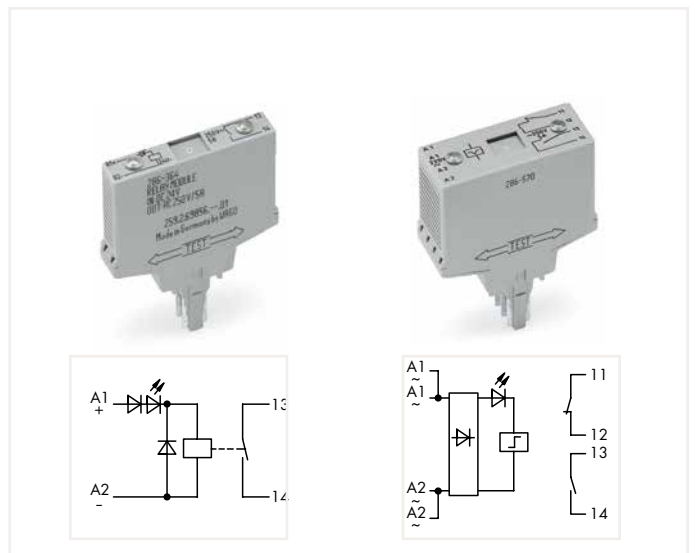

Selection of pluggable modules

7

Fuse Plugs, Pluggable Diode and LED Modules



Fuse plug; with soldered miniature fuse; 5 mm wide; gray
Electrical ratings are given by the fuse.

	Item No.	Pack. Unit
	250 mA FF 280-850	100
	500 mA FF 280-852	100
	1 A FF 280-854	100
	2 A FF 280-856	100

Diode module; with 1N4007 diode; 5 mm wide

	Item No.	Pack. Unit
	gray 280-801/281-411	100

LED module; with red LED; 5 mm wide; I_N 5.6 mA; I_F 25 mA; gray

	Item No.	Pack. Unit
	24 VDC 280-801/281-413	100
	48 VDC 280-801/281-414	100

Fuse plug; with soldered miniature fuse; with additional indicator lamp; red LED; 15 ... 30 VDC; 5 mm wide; gray
Electrical ratings are given by the fuse and blown fuse indication. Leakage current in case of a blown fuse: LED 5 ... 20 mA

	250 mA FF 280-850/281-413	100
	500 mA FF 280-852/281-413	100
	1 A FF 280-854/281-413	100
	2 A FF 280-856/281-413	100

Diode module; with 1N4007 recovery diode; red LED; 5 mm wide; gray

	24 VDC 280-801/281-420	100
	48 VDC 280-801/281-421	100

LED module; with red LED; 5 mm wide; I_N 5.6 mA; I_F 25 mA; gray

	24 VAC/DC 280-801/281-415	100
	48 VAC/VDC 280-801/281-416	100

Fuse plug with pull-tab; for 5 x 20 mm and 5 x 25 mm glass cartridge fuses; 6 mm wide
Electrical ratings are given by the fuse.

	281-511	50
--	---------	----

Neon indicator module; 5 mm wide; I_N 0.5 mA; gray

	120 VAC/VDC 280-801/281-418	100
	230 VAC/VDC 280-801/281-417	100

Fuse plug with pull-tab; for 5 x 20 mm and 5 x 25 mm glass cartridge fuses; with hole for one LED (for self-assembly); 6 mm wide; gray
Electrical ratings are given by the fuse and blown fuse indication.

	281-512	50
--	---------	----

Fuse plug with pull-tab; for 5 x 20 mm and 5 x 25 mm glass cartridge fuses; with LED; 24 VAC/DC; 6 mm wide
Electrical ratings are given by the fuse and blown fuse indication. Leakage current in case of a blown fuse: LED 5 ... 20 mA

	281-512/281-501	50
--	-----------------	----

Fuse plug with pull-tab; for 5 x 20 mm and 5 x 25 mm glass cartridge fuses; with neon lamp; 120 VAC/DC; 6 mm wide
Electrical ratings are given by the fuse and blown fuse indication. Leakage current in case of a blown fuse: Neon lamp < 0.4 mA

	281-512/281-418	50
	281-512/281-417	50

7

1-Conductor/1-Pin Double-Deck Carrier Terminal Block X-COM®-SYSTEM

2.5 (4 "f-st") mm²; 870 Series

Technical Data	
0.08 ... 2.5 (4 "f-st") mm ² ①	28 ... 12 AWG
500 V/6 kV/3 ②	300 V, 20 A, I_N
I_N 16 A	
Terminal block width: 5 mm / 0.197 inch	
6 ... 7 mm / 0.24 ... 0.28 inch	

Technical Data	
0.08 ... 2.5 (4 "f-st") mm ² ①	28 ... 12 AWG
500 V/6 kV/3 ②	
I_N 16 A	
Terminal block width: 5 mm / 0.197 inch	
6 ... 7 mm / 0.24 ... 0.28 inch	

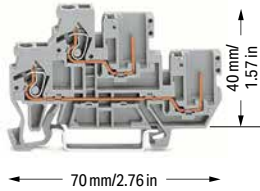

1-conductor/1-pin double-deck carrier terminal block; through/through terminal block; gray

	Item No.	Pack. Unit
○ L/L	870-101	50
○ N/L	870-102	50
○ L/N	870-103	50

1-conductor/1-pin double-deck carrier terminal block; through/through terminal block; blue

● N/N	870-104	50
-------	---------	----

Other terminal blocks with the same profile:

Through	870-501	Page 432
---------	---------	----------

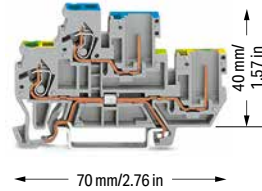

1-conductor/1-pin double-deck carrier terminal block; ground conductor/through terminal block; gray

	Item No.	Pack. Unit
○ PE/N	870-117	50
○ PE/L	870-127	50

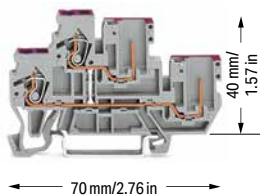

2-conductor/2-pin double-deck carrier terminal block; 2-conductor/2-pin through terminal block; internally commoned; Violet conductor entry; gray

	Item No.	Pack. Unit
○ L	870-108	50

2-conductor/2-pin double-deck carrier terminal block; 2-conductor/2-pin through terminal block; internally commoned; Violet conductor entry; blue

● N	870-109	50
-----	---------	----

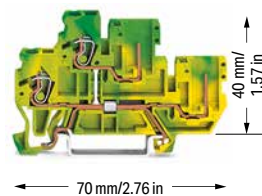

2-conductor/2-pin double-deck carrier block; 2-conductor/2-pin ground conductor block; internally commoned; green-yellow

	Item No.	Pack. Unit
● PE	870-107	50

- ① Max. insulation diameter: 4.4 mm
- ② 500 V = rated voltage
6 kV = rated impulse voltage
3 = pollution degree (see Section 15)

Note: 2-conductor female plugs cannot be used.

Please observe the application notes:
Insulation stop, page 382
Marking, from page 640

Approvals and corresponding ratings, visit www.wago.com

Accessories; 870 Series

Appropriate marking systems:
Mini-WSB/Mini-WSB Inline/WMB/WMB Inline

End and intermediate plate; 1 mm thick

 orange	870-119	100 (25)
 gray	870-118	100 (25)

Insulation stop; 0.08 ... 0.2 mm² "s" (0.14 mm² "f-st"); 5 pcs/strip

 white	280-470	200 (25)
---	---------	----------

Insulation stop; 0.25 ... 0.5 mm²; 5 pcs/strip

 light gray	280-471	200 (25)
---	---------	----------

Insulation stop; 0.75 ... 1 mm²; 5 pcs/strip

 dark gray	280-472	200 (25)
---	---------	----------

Coding pin; for coding female plugs

 orange	769-435	100 (25)
--	---------	----------

Push-in type jumper bar; insulated; I_N 18 A; light gray

 2-way	870-402	200 (25)
3-way	870-403	200 (25)
4-way	870-404	100 (25)
5-way	870-405	100 (25)
6-way	870-406	100 (25)
7-way	870-407	100 (25)
8-way	870-408	100 (25)
9-way	870-409	100 (25)
10-way	870-410	50 (25)

Push-in type jumper bar; insulated; I_N 18 A; light gray

 1 to 3	870-433	200 (25)
1 to 4	870-434	200 (25)
1 to 5	870-435	100 (25)
1 to 6	870-436	100 (25)
1 to 7	870-437	100 (25)
1 to 8	870-438	100 (25)
1 to 9	870-439	100 (25)
1 to 10	870-440	50 (25)

Pin cover; with Mini-WSB marker slot

 gray	769-438	100 (25)
orange	769-439	100 (25)

1-connector female plug; straight

 gray	769-101	200
--	---------	-----

1-conductor female plug; angled

 gray	769-101/022-000	200
--	-----------------	-----

1-Conductor/1-Pin Double-Deck Carrier Terminal Blocks and 1-/2-Conductor Female Plugs X-COM®-SYSTEM Assembly Types



Commoning a double-deck through terminal block (870-501) with a 1-conductor/1-pin double-deck terminal block (870-101) via push-in type jumper bar.

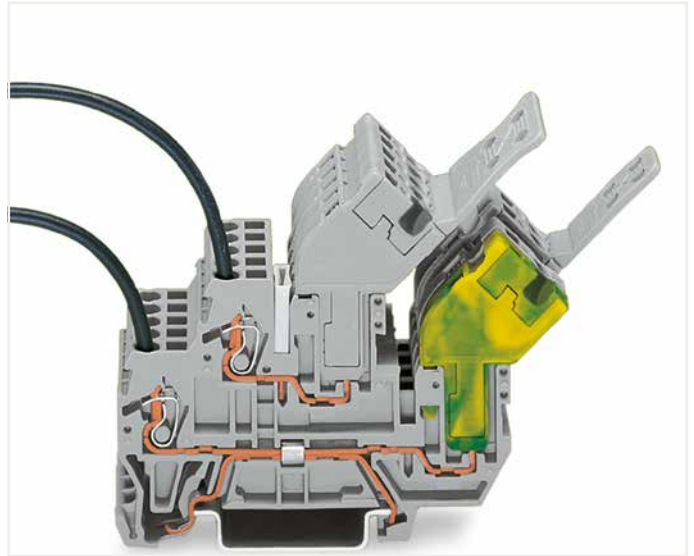

1-conductor female plug; angled
Double-deck carrier terminal blocks can be commoned via 870 Series Push-In Type Jumper Bars.

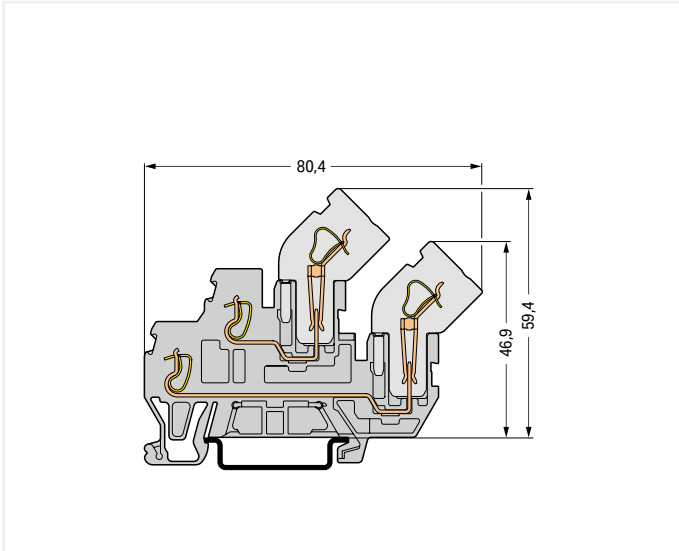

Carrier terminal block

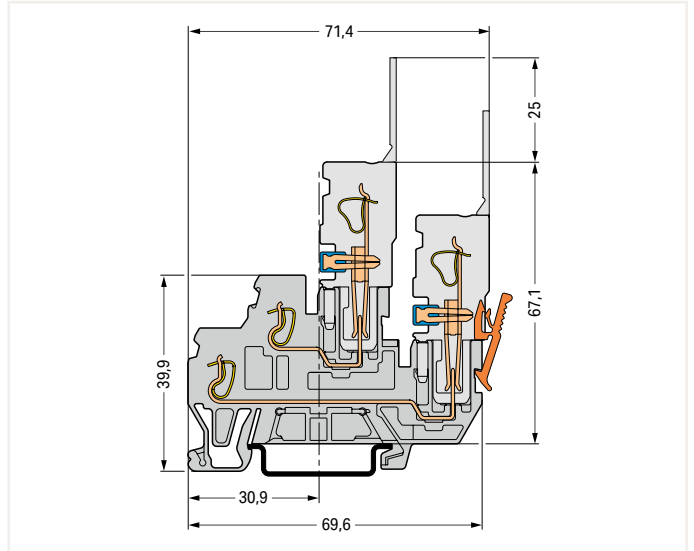

Carrier terminal block

2-Conductor/1-Pin Double-Deck Carrier Terminal Block X-COM®-SYSTEM 2.5 (4 "f-st") mm²; 870 Series

Technical Data

0.08 ... 2.5 (4 "f-st") mm² ① | 28 ... 12 AWG
 500 V/6 kW/3 ② | 300 V, 20 A I_N
 I_N 16 A
 Terminal block width: 5 mm / 0.197 inch
 6 ... 7 mm / 0.24 ... 0.28 inch

Technical Data

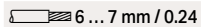
0.08 ... 2.5 (4 "f-st") mm² ① | 28 ... 12 AWG
 Terminal block width: 5 mm / 0.197 inch
 6 ... 7 mm / 0.24 ... 0.28 inch

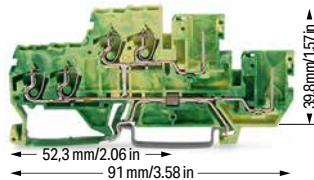
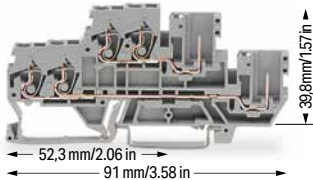

2-conductor/1-pin double-deck carrier terminal block; through/through terminal block; gray

	Item No.	Pack. Unit
<input type="radio"/> L/L	870-1131	40

4-conductor/2-pin double-deck carrier terminal block; 2-conductor/2-pin through terminal block; internally commoned; Violet conductor entry; gray

<input type="radio"/> L	870-1138	40
-------------------------	----------	----

4-conductor/2-pin double-deck carrier block; 4-conductor/2-pin ground conductor block; internally commoned; green-yellow

	Item No.	Pack. Unit
<input type="radio"/> PE/N	870-1137	40

① Max. insulation diameter: 4.4 mm

② 500 V = rated voltage
 6 kV = rated impulse voltage
 3 = pollution degree
 (see Section 15)

Note: 2-conductor female plugs cannot be used.



Please observe the application notes:
 Insulation stop, page 382
 Marking, from page 640

Approvals and corresponding ratings, visit www.wago.com

Accessories; 870 Series

Appropriate marking systems:
 Mini-WSB/Mini-WSB Inline/WMB/WMB Inline

End and intermediate plate; 1 mm thick

	orange	870-1149	100 (25)
	gray	870-1148	100 (25)

Insulation stop; 0.08 ... 0.2 mm² "s" (0.14 mm² "f-st"); 5 pcs/strip

	white	280-470	200 (25)
---	-------	---------	----------

Insulation stop; 0.25 ... 0.5 mm²; 5 pcs/strip

	light gray	280-471	200 (25)
---	------------	---------	----------

Insulation stop; 0.75 ... 1 mm²; 5 pcs/strip

	dark gray	280-472	200 (25)
---	-----------	---------	----------

Coding pin; for coding female plugs

	orange	769-435	100 (25)
---	--------	---------	----------

Push-in type jumper bar; insulated; I_N 18 A; light gray

	2-way	870-402	200 (25)
	3-way	870-403	200 (25)
	4-way	870-404	100 (25)
	5-way	870-405	100 (25)
	6-way	870-406	100 (25)
	7-way	870-407	100 (25)
	8-way	870-408	100 (25)
	9-way	870-409	100 (25)
	10-way	870-410	50 (25)

Push-in type jumper bar; insulated; I_N 18 A; light gray

	1 to 3	870-433	200 (25)
	1 to 4	870-434	200 (25)
	1 to 5	870-435	100 (25)
	1 to 6	870-436	100 (25)
	1 to 7	870-437	100 (25)
	1 to 8	870-438	100 (25)
	1 to 9	870-439	100 (25)
	1 to 10	870-440	50 (25)

Pin cover; with Mini-WSB marker slot

	gray	769-438	100 (25)
	orange	769-439	100 (25)

1-conductor female plug; straight

	gray	769-101	200
---	------	---------	-----

1-conductor female plug; angled

	gray	769-101/022-000	200
---	------	-----------------	-----

7

2-Pin/2-Pin Double-Deck Carrier Terminal Block X-COM®-SYSTEM 870 Series

Technical Data

500 V/6 kV/3 ① | 300 V, 20 A, $I_{N, 300}$

I_N 16 A

Terminal block width: 5 mm / 0.197 inch

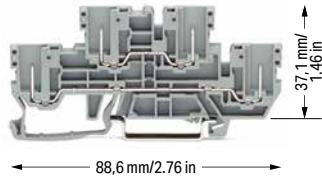

2-pin/2-pin double-deck carrier terminal block; through/through terminal block; gray

	Item No.	Pack. Unit
○ L/L	870-151	50

Technical Data

Terminal block width: 5 mm / 0.197 inch

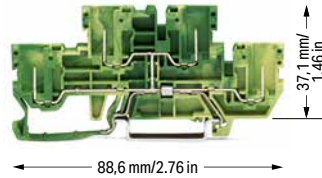

4-pin double-deck carrier block; 4-pin ground conductor block; internally commoned; green-yellow

	Item No.	Pack. Unit
● PE	870-157	50

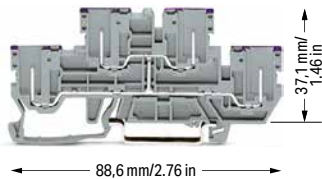

4-pin double-deck carrier terminal block; 4-pin through terminal block; internally commoned; Violet conductor entry; gray

	Item No.	Pack. Unit
○ L	870-158	50

- ① 500 V = rated voltage
- 6 kV = rated impulse voltage
- 3 = pollution degree
- (see Section 15)

Note: 2-conductor female plugs cannot be used.

Approvals and corresponding ratings, visit www.wago.com

Accessories; 870 Series

Appropriate marking systems:
Mini-WSB/Mini-WSB Inline/WMB/WMB Inline

End and intermediate plate; 1 mm thick

	orange	870-169	100 (25)
	gray	870-168	100 (25)

Coding pin; for coding female plugs

	orange	769-435	100 (25)
--	--------	---------	----------

Push-in type jumper bar; insulated; I_N 18 A; light gray

	2-way	870-402	200 (25)
	3-way	870-403	200 (25)
	4-way	870-404	100 (25)
	5-way	870-405	100 (25)
	6-way	870-406	100 (25)
	7-way	870-407	100 (25)
	8-way	870-408	100 (25)
	9-way	870-409	100 (25)
	10-way	870-410	50 (25)

Push-in type jumper bar; insulated; I_N 18 A; light gray

	1 to 3	870-433	200 (25)
	1 to 4	870-434	200 (25)
	1 to 5	870-435	100 (25)
	1 to 6	870-436	100 (25)
	1 to 7	870-437	100 (25)
	1 to 8	870-438	100 (25)
	1 to 9	870-439	100 (25)
	1 to 10	870-440	50 (25)

Pin cover; with Mini-WSB marker slot

	gray	769-438	100 (25)
	orange	769-439	100 (25)

1-conductor female plug; straight

	gray	769-101	200
--	------	---------	-----

1-conductor female plug; angled

	gray	769-101/022-000	200
--	------	-----------------	-----

Mini-WSB Inline, plain; 1,700 WMB markers (5 mm)/reel; 5 ... 5.2 mm stretchable

	white	2009-145	1
--	-------	----------	---

Mini-WSB marking card; white; 10 strips with 10 markers/card; 5 mm wide markers

	plain	248-501	5
--	-------	---------	---

7

2-Pin/2-Pin Double-Deck Carrier Terminal Blocks and 1-Conductor Female Plugs X-COM®-SYSTEM Assembly Types



1-conductor female plug; straight
Double-deck carrier terminal blocks can be commoned via 870 Series Push-In Type Jumper Bars.
Notice: 2-conductor female plugs cannot be used.

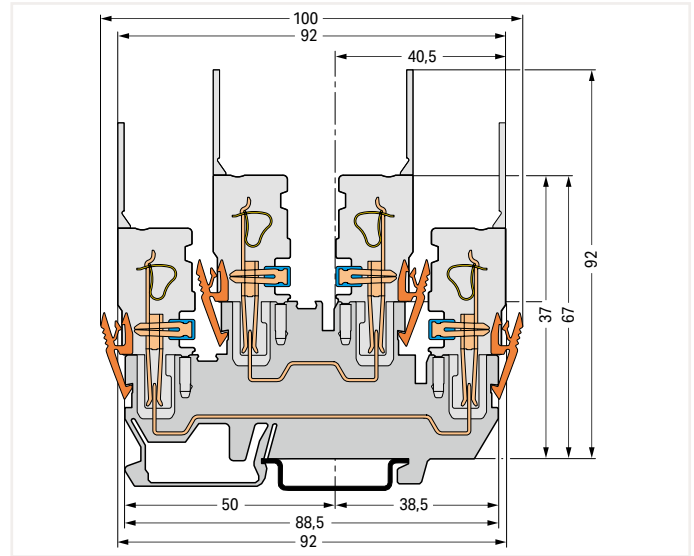

Carrier terminal block

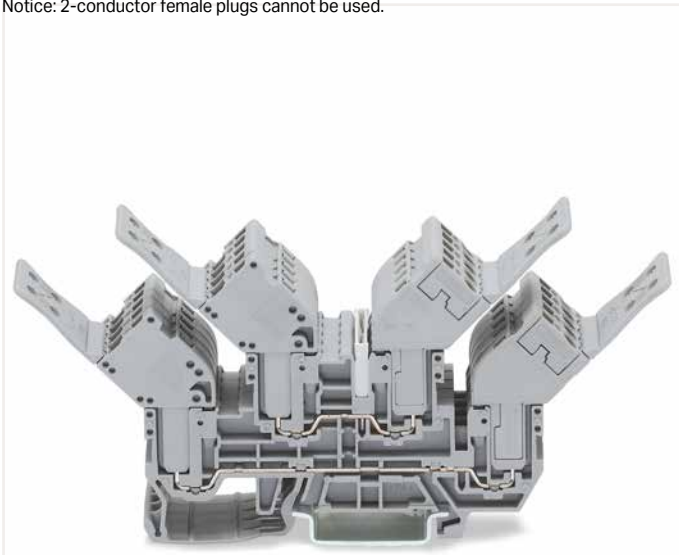

1-conductor female plug; angled
Double-deck carrier terminal blocks can be commoned via 870 Series Push-In Type Jumper Bars.

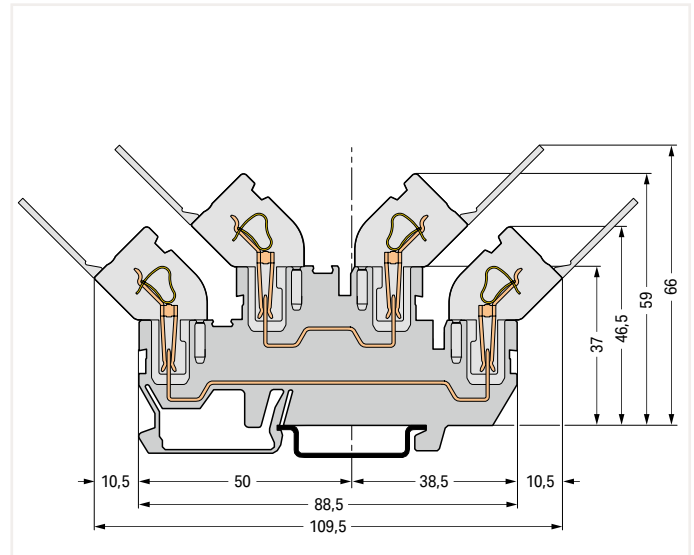

Carrier terminal block

2-Conductor/2-Pin Double-Deck Carrier Terminal Block X-COM®-SYSTEM 2.5 (4 "f-st") mm²; 870 Series

Technical Data

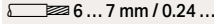
0.08 ... 2.5 (4 "f-st") mm² ① | 28 ... 12 AWG
 500 V/6 kW/3 ② | 300 V, 20 A I_N
 I_N 16 A
 Terminal block width: 5 mm / 0.197 inch
 6 ... 7 mm / 0.24 ... 0.28 inch

Technical Data

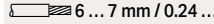
0.08 ... 2.5 (4 "f-st") mm² ① | 28 ... 12 AWG
 Terminal block width: 5 mm / 0.197 inch
 6 ... 7 mm / 0.24 ... 0.28 inch

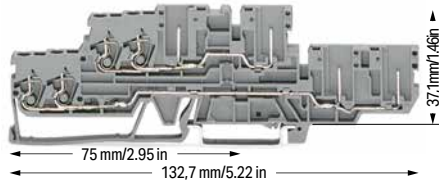

2-conductor/2-pin double-deck carrier terminal block; through/through terminal block; gray

	Item No.	Pack. Unit
○ L/L	870-131	40

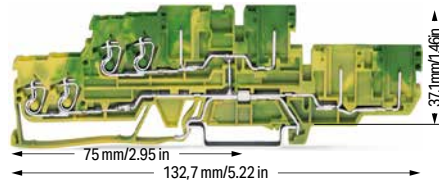

4-conductor/4-pin double-deck carrier block; 4-conductor/4-pin ground conductor block; internally commoned; green-yellow

	Item No.	Pack. Unit
● PE	870-137	40

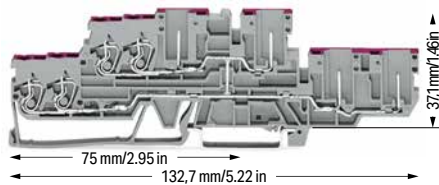

4-conductor/4-pin double-deck carrier terminal block; 4-conductor/4-pin through terminal block; internally commoned; Violet conductor entry; gray

	Item No.	Pack. Unit
○ L	870-138	40

- ① Max. insulation diameter: 4.4 mm
- ② 500 V = rated voltage
6 kV = rated impulse voltage
3 = pollution degree
(see Section 15)

Note: 2- and 1-conductor angled female plugs cannot be used.

Please observe the application notes:
 Insulation stop, page 382
 Marking, from page 640

Approvals and corresponding ratings, visit www.wago.com

Accessories; 870 Series

Appropriate marking systems:
 Mini-WSB/Mini-WSB Inline/WMB/WMB Inline

End and intermediate plate; 1 mm thick

	orange	870-149	100 (25)
	gray	870-148	100 (25)

Insulation stop; 0.08 ... 0.2 mm² "s" (0.14 mm² "f-st"); 5 pcs/strip

	white	280-470	200 (25)
---	-------	---------	----------

Insulation stop; 0.25 ... 0.5 mm²; 5 pcs/strip

	light gray	280-471	200 (25)
--	------------	---------	----------

Insulation stop; 0.75 ... 1 mm²; 5 pcs/strip

	dark gray	280-472	200 (25)
---	-----------	---------	----------

Coding pin; for coding female plugs

	orange	769-435	100 (25)
---	--------	---------	----------

Push-in type jumper bar; insulated; I_N 18 A; light gray

	2-way	870-402	200 (25)
	3-way	870-403	200 (25)
	4-way	870-404	100 (25)
	5-way	870-405	100 (25)
	6-way	870-406	100 (25)
	7-way	870-407	100 (25)
	8-way	870-408	100 (25)
	9-way	870-409	100 (25)
	10-way	870-410	50 (25)

Push-in type jumper bar; insulated; I_N 18 A; light gray

	1 to 3	870-433	200 (25)
	1 to 4	870-434	200 (25)
	1 to 5	870-435	100 (25)
	1 to 6	870-436	100 (25)
	1 to 7	870-437	100 (25)
	1 to 8	870-438	100 (25)
	1 to 9	870-439	100 (25)
	1 to 10	870-440	50 (25)

Pin cover; with Mini-WSB marker slot

	gray	769-438	100 (25)
	orange	769-439	100 (25)

1-connector female plug; straight

	gray	769-101	200
---	------	---------	-----

7

2-Conductor/2-Pin Double-Deck Carrier Terminal Blocks and 1-Conductor Female Plugs X-COM®-SYSTEM Assembly Types

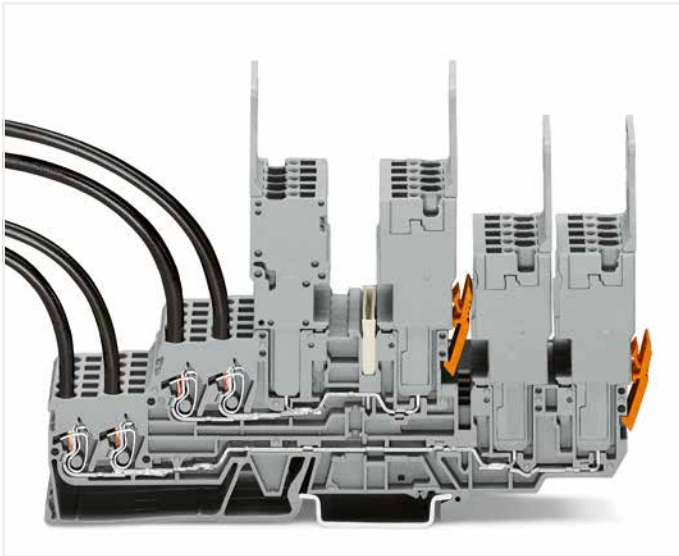

1-conductor female plug; straight

Double-deck carrier terminal blocks can be commoned via 870 Series Push-In Type Jumper Bars.

Notice: Female plugs must be arranged in the opposite direction on the upper deck.
2-conductor female plugs and angled 1-conductor female plugs cannot be used.

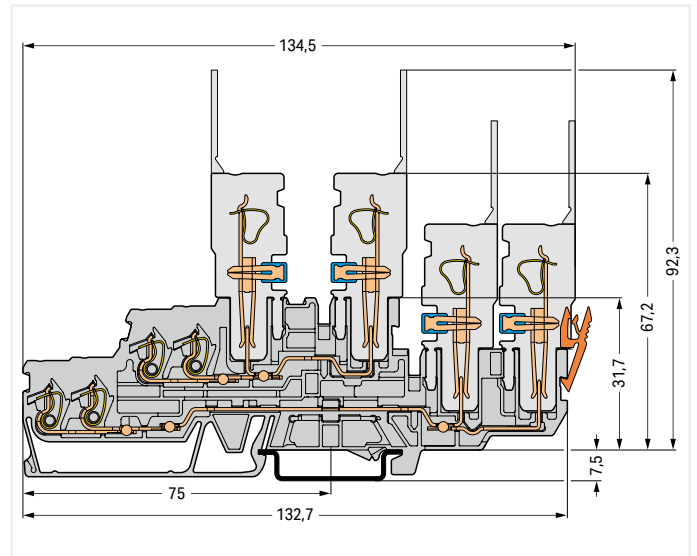

Carrier terminal block

Male Connectors, Headers and Female Plugs X-COM®-SYSTEM

769 Series

Description and Installation



Male connector; with CAGE CLAMP® connection
1-connector female plug; straight

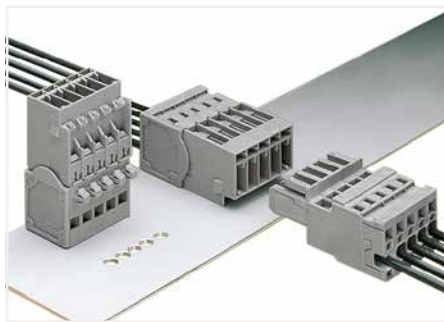

Male connector; with CAGE CLAMP® connection and
snap-in mounting feet
1-connector female plug; straight

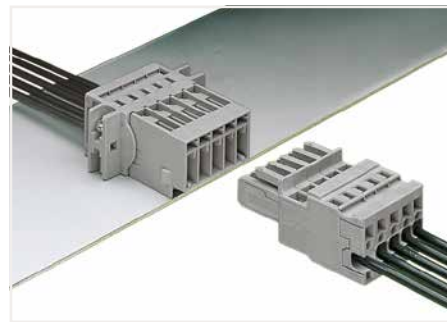

Male connector; with CAGE CLAMP® and mounting flanges
1-connector female plug; straight



Insert a male connector with snap-in flanges
(769-604/005-000) into the cutout.



Male connector; with snap-in flanges
Tool-free assembly



Male connector; with snap-in flanges
Tool-free assembly



Operating tool
Inserting a conductor – side-entry wiring (example shows
a female plug).
With ferruled conductors, it is necessary to use a terminal
block one size smaller than the conductor's nominal cross
section.



Operating tool
Inserting a conductor via operating tool (example shows a
male connector).

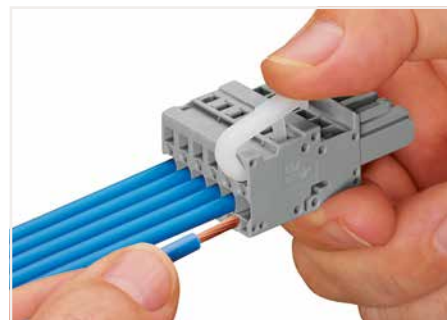

Operating lever
Conductor termination – side-entry wiring (example shows
a female plug)



Strain relief plates can be snapped into both male connector
and female plug.

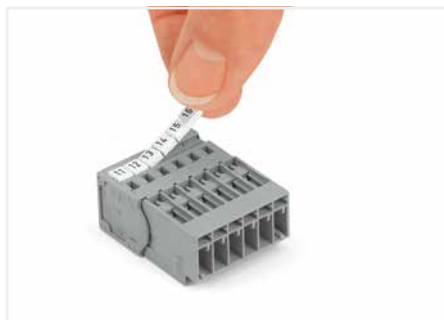

Labeling a male connector with CAGE CLAMP® connection
via Mini-WSB Quick Markers.



Labeling a female plug with CAGE CLAMP® connection via
Mini-WSB Quick Markers.



CAGE CLAMP® terminates the
following copper conductors:
solid "s"



stranded "st"



fine-stranded "f-st",
also with tinned
single strands

With ferruled conductors, it is necessary to use a terminal block one size smaller than the conductor's nominal cross section.



Coding a female plug by removing coding finger(s) via cutting tool. Do not remove the first and last coding fingers or use an additional locking lever.

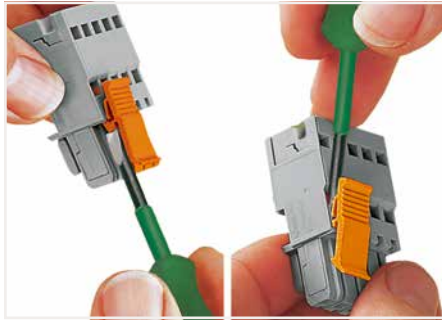

Locking/releasing a lever.



Commoning a 1-conductor female plug via miniature adjacent jumpers.

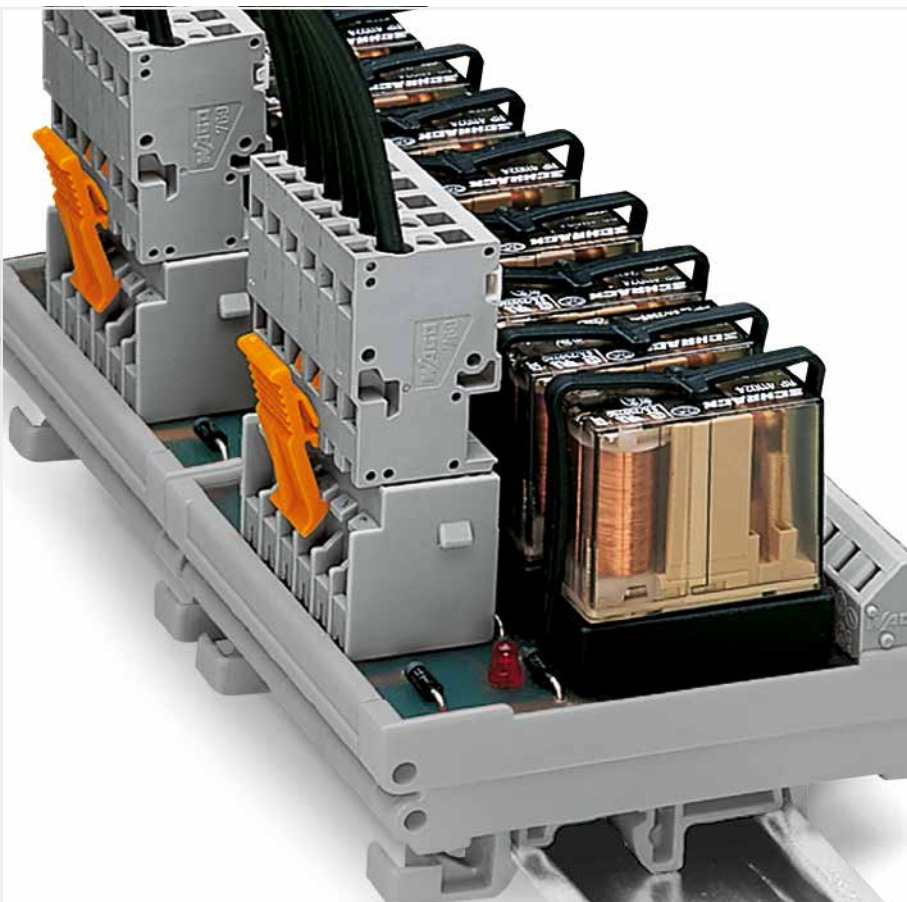

Note: Female plugs used according to the regulations must not be connected/disconnected when live or under load.

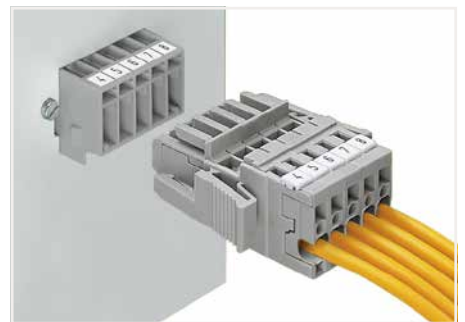

Male header and 1-conductor female plug; with lateral locking levers

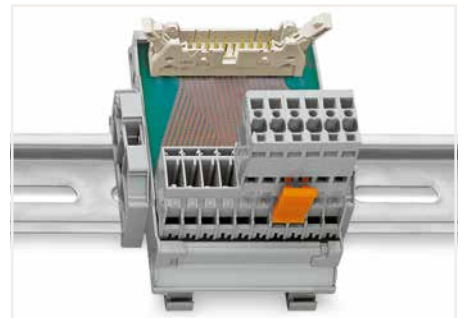

Male header; with solder pins for PCBs

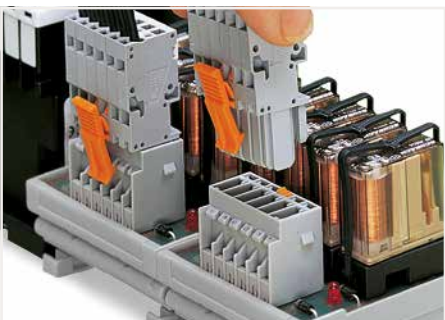

Pluggable PCB connection
Connection to a relay module inside the control cabinet

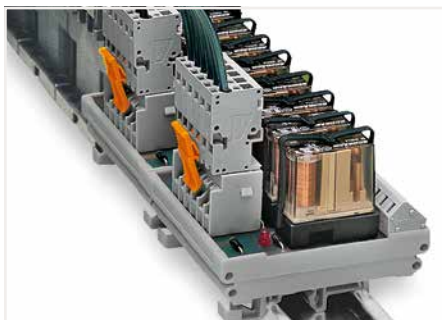

Male header; with straight solder pins and 1-conductor female plug (picture shows a relay module)

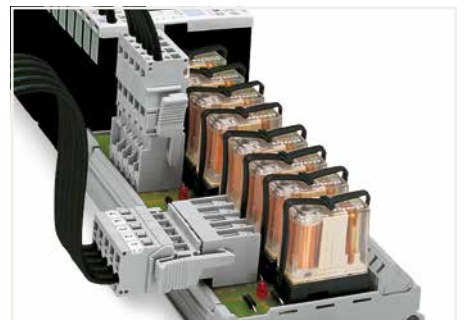

Male header; with solder pins
Integrating PCB components into the system wiring.



fine-stranded,
tip-bonded



fine-stranded,
with ferrule
(gastight crimped)



fine-stranded,
with pin terminal
(gastight crimped)

Male Connector X-COM®-SYSTEM; with CAGE CLAMP® Connection; 5 mm Pin Spacing 4 mm²; 769 Series

Technical Data

Pin spacing: 5 mm / 0.197 inch

0.08 ... 4 mm² 28 ... 12 AWG

500 V/6 kV/3 ① 300 V, 20 A ②

I_N 32 A ③ 300 V, 20 A ④

8 ... 9 mm / 0.31 ... 0.35 inch

Technical Data

Pin spacing: 5 mm / 0.197 inch

0.08 ... 4 mm² 28 ... 12 AWG

500 V/6 kV/3 ① 300 V, 20 A ②

I_N 32 A ③ 300 V, 20 A ④

8 ... 9 mm / 0.31 ... 0.35 inch

Technical Data

Pin spacing: 5 mm / 0.197 inch

0.08 ... 4 mm² 28 ... 12 AWG

500 V/6 kV/3 ① 300 V, 20 A ②

I_N 32 A ③ 300 V, 20 A ④

8 ... 9 mm / 0.31 ... 0.35 inch



Dimensions (in mm)

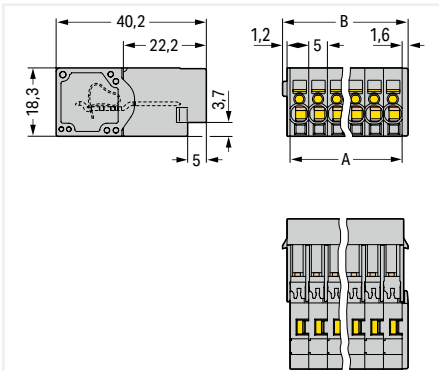

B = A + 3.6 mm
A = pole no. x pin spacing

Dimensions (in mm)

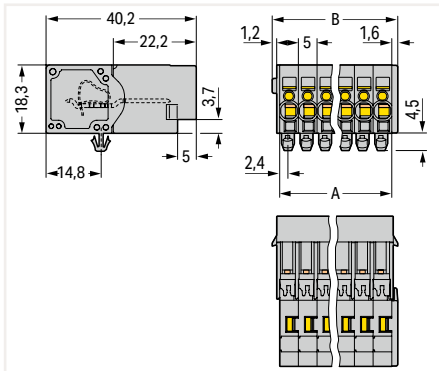

B = A + 3.6 mm
A = pole no. x pin spacing

Dimensions (in mm)

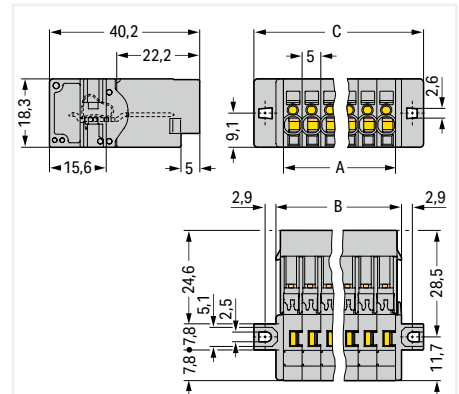

C = A + 15.4 mm
B = A + 3.6 mm
A = pole no. x pin spacing

Male connector; with CAGE CLAMP® connection; for flying leads; gray

Pole No.	Item No.	Pack. Unit
○ 2	769-602	100
○ 3	769-603	100
○ 4	769-604	100
○ 5	769-605	50
○ 6	769-606	50
○ 7	769-607	25
○ 8	769-608	25
○ 9	769-609	25
○ 10	769-610	25
○ 11	769-611	25
○ 12	769-612	25
○ 13	769-613	25
○ 14	769-614	15
○ 15	769-615	10

Male connector; with CAGE CLAMP® connection and snap-in mounting feet; for 0.6 ... 1.2 mm plate thickness; 3.5 mm Ø mounting holes; with mounting adapter (209-137) for DIN-35 rail; gray

Pole No.	Item No.	Pack. Unit
○ 2	769-602/001-000	100
○ 3	769-603/001-000	100
○ 4	769-604/001-000	50
○ 5	769-605/001-000	50
○ 6	769-606/001-000	50
○ 7	769-607/001-000	25
○ 8	769-608/001-000	25
○ 9	769-609/001-000	25
○ 10	769-610/001-000	25
○ 11	769-611/001-000	25
○ 12	769-612/001-000	25
○ 13	769-613/001-000	15
○ 14	769-614/001-000	15
○ 15	769-615/001-000	20

Male connector; with CAGE CLAMP® connection and mounting flanges; for screw or similar mounting types; for vertical or horizontal mounting; gray

Pole No.	Item No.	Pack. Unit
○ 2	769-602/002-000	100
○ 3	769-603/002-000	50
○ 4	769-604/002-000	50
○ 5	769-605/002-000	50
○ 6	769-606/002-000	50
○ 7	769-607/002-000	25
○ 8	769-608/002-000	25
○ 9	769-609/002-000	25
○ 10	769-610/002-000	25
○ 11	769-611/002-000	25
○ 12	769-612/002-000	25
○ 13	769-613/002-000	15
○ 14	769-614/002-000	10
○ 15	769-615/002-000	20

Accessories; item-specific

Strain relief plate; gray

	2- ... 3-pole	769-411	100 (25)
	4- ... 5-pole	769-412	100 (25)
	6- ... 9-pole	769-413	100 (25)
	10- ... 15-pole	769-414	100 (25)

Accessories; item-specific

Mounting adapter; for DIN-35 rail; can be used as end plate; 6.5 mm wide

	gray	209-137	25
--	------	---------	----

Accessories; item-specific

Mounting screw (M2.5 x 16) and hexagon nut (M2.5)

		769-499	100 (25)
--	--	---------	----------

Technical Data

Pin spacing: 5 mm / 0.197 inch

0.08 ... 4 mm² | 28 ... 12 AWG

500 V/6 kV/3 ① | 300 V, 20 A

I_N 32 A ② | 300 V, 20 A

8 ... 9 mm / 0.31 ... 0.35 inch



Dimensions (in mm)

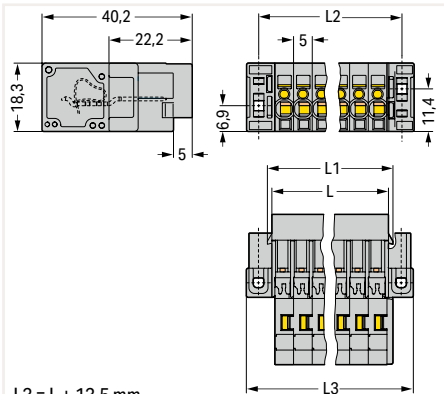

L3 = L + 13.5 mm
 L2 = L + 7 mm
 L1 = L + 2.4 mm
 L = (pole no. - 1) x pin spacing + 6.2 mm

Male connector; with CAGE CLAMP® connection and feedthrough flanges; for screw or similar mounting types; for vertical or horizontal mounting; gray

Pole No.	Item No.	Pack. Unit
○ 2	769-602/004-000	100
○ 3	769-603/004-000	50
○ 4	769-604/004-000	25
○ 5	769-605/004-000	25
○ 6	769-606/004-000	25
○ 7	769-607/004-000	25
○ 8	769-608/004-000	25
○ 9	769-609/004-000	25
○ 10	769-610/004-000	25
○ 11	769-611/004-000	25
○ 12	769-612/004-000	15
○ 13	769-613/004-000	15
○ 14	769-614/004-000	10
○ 15	769-615/004-000	10

- ① 500 V = rated voltage
6 kV = rated impulse voltage
3 = pollution degree
(see Section 15)

- ② Current-carrying capacity curve on page 455 and upon request

Approvals and corresponding ratings, visit www.wago.com

Accessories; for male connectors

Appropriate marking systems:
Mini-WSB/Mini-WSB Inline

1-conductor female plug; straight

	gray	769-102	100
--	------	---------	-----

1-conductor female plug; with lateral locking levers

	gray	769-102/021-000	50
--	------	-----------------	----

2-conductor female plug

	gray	769-122	50
--	------	---------	----

Coding pin; for coding female plugs

	orange	769-435	100 (25)
--	--------	---------	----------

Operating tool; for female plugs and male connectors with CAGE CLAMP® connection

		210-490	1
--	--	---------	---

Operating lever; loose; for male and female connectors with CAGE CLAMP® connection

		769-434	2000 (100)
--	--	---------	------------

Mini-WSB Inline, plain; 1,700 WMB markers (5 mm)/reel; 5 ... 5.2 mm stretchable

	white	2009-145	1
--	-------	----------	---

Mini-WSB marking card; white; 10 strips with 10 markers/card; 5 mm wide markers

	plain	248-501	5
--	-------	---------	---



Male connector; with CAGE CLAMP® connection
1-conductor female plug; straight



Labeling a male connector with CAGE CLAMP® connection via Mini-WSB Quick Markers.

CAGE CLAMP®

Male Connector X-COM®-SYSTEM; with CAGE CLAMP® Connection and Snap-In Flanges; 5 mm Pin Spacing

4 mm²; 769 Series

Technical Data

Pin spacing: 5 mm / 0.197 inch	
0.08 ... 4 mm ²	28 ... 12 AWG
500 V/6 kV/3 ①	300 V, 20 A ②
I _N 32 A ②	300 V, 20 A ③
8 ... 9 mm / 0.31 ... 0.35 inch	



- ① 500 V = rated voltage
6 kV = rated impulse voltage
3 = pollution degree
(see Section 15)
 - ② Current-carrying capacity curves upon request
- Approvals and corresponding ratings, visit www.wago.com

Accessories; for male connectors
Appropriate marking systems:
Mini-WSB/Mini-WSB Inline

1-conductor female plug; straight

gray	769-102	100
------	---------	-----

1-conductor female plug; with lateral locking levers

gray	769-102/021-000	50
------	-----------------	----

2-conductor female plug

gray	769-122	50
------	---------	----

Coding pin; for coding female plugs

orange	769-435	100 (25)
--------	---------	----------

Operating tool; for female plugs and male connectors with CAGE CLAMP® connection

	210-490	1
--	---------	---

Operating lever; loose; for male and female connectors with CAGE CLAMP® connection

	769-434	2000 (100)
--	---------	------------

Mini-WSB Inline, plain; 1,700 WMB markers (5 mm)/reel; 5 ... 5.2 mm stretchable

white	2009-145	1
-------	----------	---

Mini-WSB marking card; white; 10 strips with 10 markers/card; 5 mm wide markers

plain	248-501	5
-------	---------	---

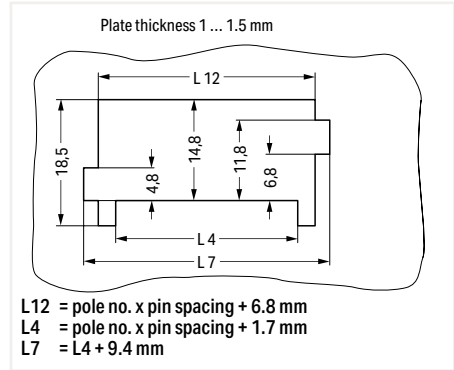

Cutout
Male connector with CAGE CLAMP® connection (769-6xx/005-000) and snap-in flanges



Insert a male connector with snap-in flanges (769-604/005-000) into the cutout.



Male connector; with snap-in flanges
Tool-free assembly



Male connector; with snap-in flanges
Tool-free assembly

Dimensions (in mm)

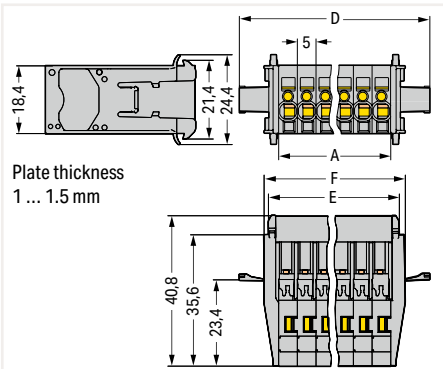

F = A + 8.1 mm
E = A + 4.9 mm
D = A + 21.3 mm
A = pole no. x pin spacing

Male connector; with CAGE CLAMP® connection and snap-in flanges; for flying leads; gray

Pole No.	Item No.	Pack. Unit
2	769-602/005-000	50
3	769-603/005-000	25
4	769-604/005-000	25
5	769-605/005-000	25
6	769-606/005-000	25
7	769-607/005-000	25
8	769-608/005-000	20
9	769-609/005-000	20
10	769-610/005-000	20
11	769-611/005-000	15
12	769-612/005-000	15
13	769-613/005-000	15
14	769-614/005-000	10
15	769-615/005-000	10

7



Male Connector X-COM®-SYSTEM; with CAGE CLAMP® Connection and Snap-In Flanges; 5 mm Pin Spacing

4 mm²; 769 Series

Technical Data

Pin spacing: 5 mm / 0.197 inch	
0.08 ... 4 mm ²	28 ... 12 AWG
500 V/6 kV/3 ①	300 V, 20 A
I _N 32 A ②	300 V, 20 A
8 ... 9 mm / 0.31 ... 0.35 inch	

- ① 500 V = rated voltage
6 kV = rated impulse voltage
3 = pollution degree
(see Section 15)
 - ② Current-carrying capacity curves upon request
- Approvals and corresponding ratings, visit www.wago.com

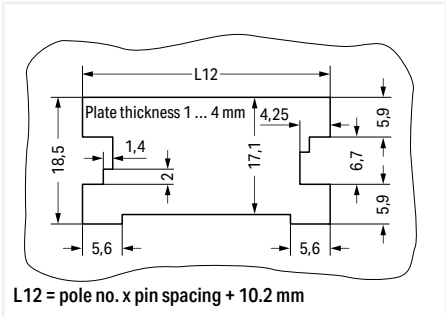

Sheet metal cutout (for female connectors without locking levers)
Male connector with CAGE CLAMP® connection (769-6xx/006-000) and snap-in flanges



Dimensions (in mm)

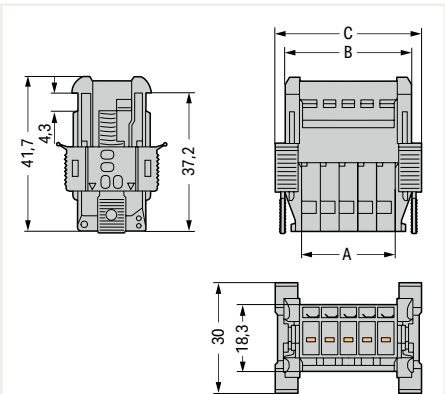

$C = A + 14.3 \text{ mm}$
 $B = A + 9.3 \text{ mm}$
 $A = \text{pole no.} \times \text{pin spacing}$

Male connector; with CAGE CLAMP® connection and snap-in flanges; for flying leads; gray

Pole No.	Item No.	Pack. Unit
2	769-602/006-000	50
3	769-603/006-000	25
4	769-604/006-000	25
5	769-605/006-000	25
6	769-606/006-000	25
7	769-607/006-000	25
8	769-608/006-000	20
9	769-609/006-000	20
10	769-610/006-000	20
11	769-611/006-000	15
12	769-612/006-000	15
13	769-613/006-000	15
14	769-614/006-000	10
15	769-615/006-000	10



Insert a male connector with snap-in flanges (769-605/006-000) into the cutout.



Secure the snap-in flange.



For removal, insert operating tool (2.5 mm blade) into release slot.

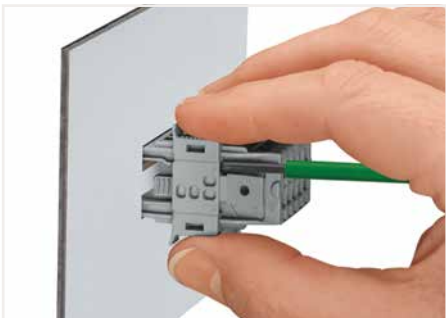

Press center part on both the top and bottom of the connector. Then remove snap-in flange.

Male Header X-COM®-SYSTEM; with Solder Pins; 5 mm Pin Spacing 769 Series

Technical Data

Pin spacing: 5 mm / 0.197 inch

250 V/4 kV/3 ① | 300 V, 20 A ②

500 V/4 kV/3 ① | 300 V, 20 A ②

I_N 32 A ②

Technical Data

Pin spacing: 5 mm / 0.197 inch

250 V/4 kV/3 ① | 300 V, 20 A ②

500 V/4 kV/3 ① | 300 V, 20 A ②

I_N 32 A ②

- ① 250 V / 500 V = rated voltage
4 kV = rated impulse voltage
3 = pollution degree
(see Section 15)

- ② Current-carrying capacity curve on page 456 and upon request

Approvals and corresponding ratings, visit www.wago.com



Dimensions (in mm)

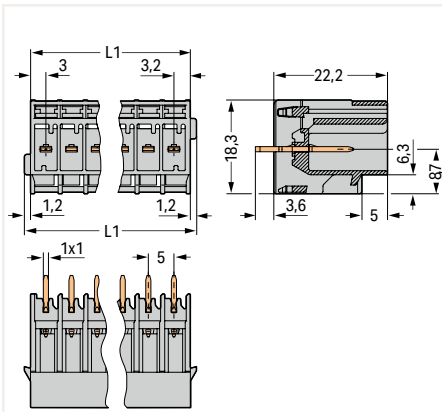

$L1 = L + 2.4 \text{ mm}$
 $L = (\text{pole no.} - 1) \times \text{pin spacing} + 6.2 \text{ mm}$

Dimensions (in mm)

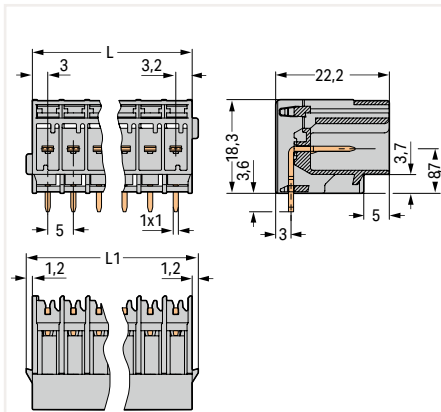

$L1 = L + 2.4 \text{ mm}$
 $L = (\text{pole no.} - 1) \times \text{pin spacing} + 6.2 \text{ mm}$

Male header; with straight solder pins; 1 x 1 mm; Vertical mating direction to the PCB; gray

Pole No.	Item No.	Pack. Unit
2	769-632	200
3	769-633	100
4	769-634	50
5	769-635	50
6	769-636	50
7	769-637	50
8	769-638	25
9	769-639	25
10	769-640	25
11	769-641	25
12	769-642	25
13	769-643	25
14	769-644	25
15	769-645	25

Male header; with angled solder pins; 1 x 1 mm; Horizontal mating direction to the PCB; gray

Pole No.	Item No.	Pack. Unit
2	769-662	200
3	769-663	100
4	769-664	50
5	769-665	50
6	769-666	50
7	769-667	50
8	769-668	25
9	769-669	25
10	769-670	25
11	769-671	25
12	769-672	25
13	769-673	25
14	769-674	25
15	769-675	25

Male header; with preceding contact; with straight solder pins; 1 x 1 mm; Vertical mating direction to the PCB; gray

2	769-632/000-036	200
3	769-633/000-036	100
4	769-634/000-036	50
5	769-635/000-036	50

Accessories; for male connectors

1-conductor female plug; straight

	gray	769-102	100
--	------	---------	-----

1-conductor female plug; with lateral locking levers

	gray	769-102/021-000	50
--	------	-----------------	----

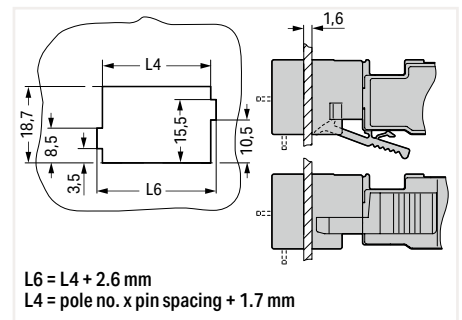

Cutout
Male header; with solder pins

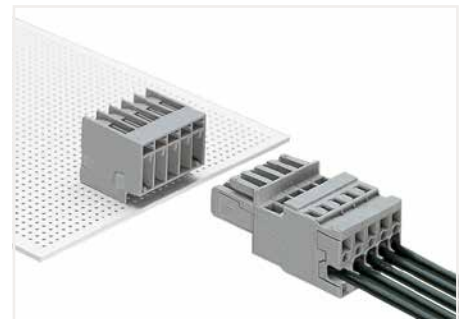

Male header; with angled solder pins

Male Header X-COM®-SYSTEM; with Solder Pins and Mounting Flanges; 5 mm Pin Spacing 769 Series

Technical Data

Pin spacing: 5 mm / 0.197 inch

250 V/4 kV/3 ① 300 V, 20 A^{RA}

500 V/4 kV/3 ① 300 V, 20 A^{RE}

I_N 32 A ②

Technical Data

Pin spacing: 5 mm / 0.197 inch

250 V/4 kV/3 ① 300 V, 20 A^{RA}

500 V/4 kV/3 ① 300 V, 20 A^{RE}

I_N 32 A ②

- ① 250 V / 500 V = rated voltage
4 kV = rated impulse voltage
3 = pollution degree
(see Section 15)

- ② Current-carrying capacity curve on page 456 and upon request

Approvals and corresponding ratings, visit www.wago.com

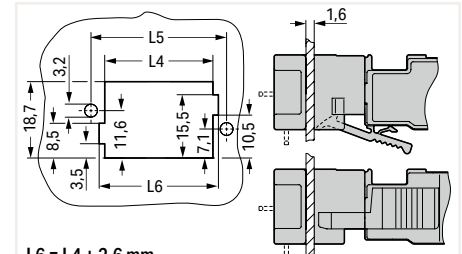

L6 = L4 + 2.6 mm
L5 = L5 + 6.6 mm
L4 = pole no. x pin spacing + 1.7 mm

Cutout

Male header; with solder pins and mounting flanges

Dimensions (in mm)

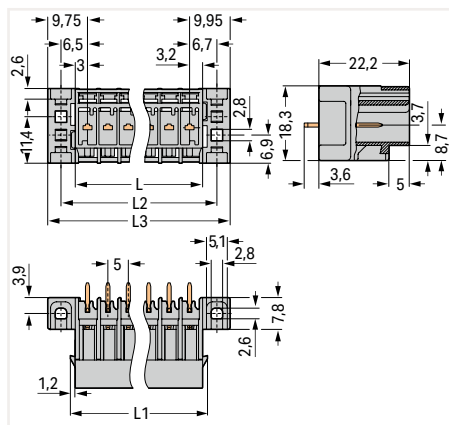

L1 = L + 2.4 mm, L2 = L + 7 mm, L3 = L + 13.5 mm
L = (pole no. - 1) x pin spacing + 6.2 mm

Dimensions (in mm)

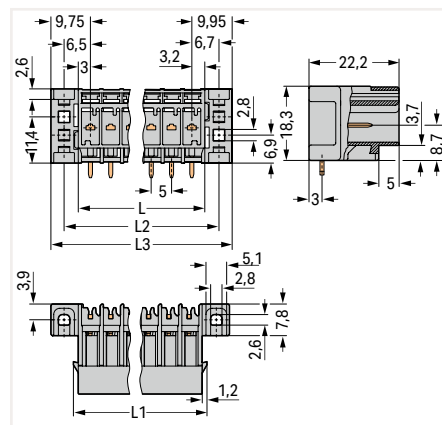

L1 = L + 2.4 mm, L2 = L + 7 mm, L3 = L + 13.5 mm
L = (pole no. - 1) x pin spacing + 6.2 mm

Male header; with straight solder pins and mounting flanges; 1 x 1 mm; Vertical mating direction to the PCB; gray

Pole No.	Item No.	Pack. Unit
2	769-632/003-000	200
3	769-633/003-000	100
4	769-634/003-000	50
5	769-635/003-000	50
6	769-636/003-000	25
7	769-637/003-000	25
8	769-638/003-000	25
9	769-639/003-000	25
10	769-640/003-000	25
11	769-641/003-000	25
12	769-642/003-000	25
13	769-643/003-000	15
14	769-644/003-000	15
15	769-645/003-000	15

Male header; with angled solder pins and mounting flanges; 1 x 1 mm; Horizontal mating direction to the PCB; gray

Pole No.	Item No.	Pack. Unit
2	769-662/003-000	100
3	769-663/003-000	100
4	769-664/003-000	50
5	769-665/003-000	50
6	769-666/003-000	50
7	769-667/003-000	25
8	769-668/003-000	25
9	769-669/003-000	25
10	769-670/003-000	25
11	769-671/003-000	25
12	769-672/003-000	25
13	769-673/003-000	15
14	769-674/003-000	15
15	769-675/003-000	15

Male header; with preceding contact; with straight solder pins and mounting flanges; 1 x 1 mm; Vertical mating direction to the PCB; gray

Pole No.	Item No.	Pack. Unit
2	769-632/003-036	200
3	769-633/003-036	100
4	769-634/003-036	50
5	769-635/003-036	50
6	769-636/003-036	25

Accessories; for male connectors

1-conductor female plug; straight	gray	769-102	100

1-conductor female plug; with lateral locking levers	gray	769-102/021-000	50

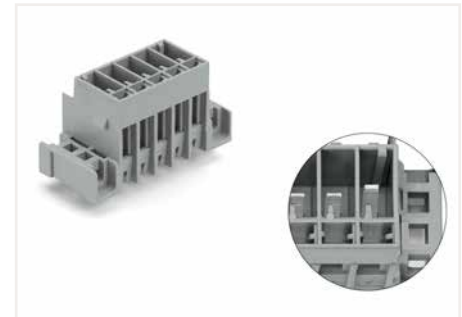

Male header; with preceding contact; with straight solder pins and mounting flanges

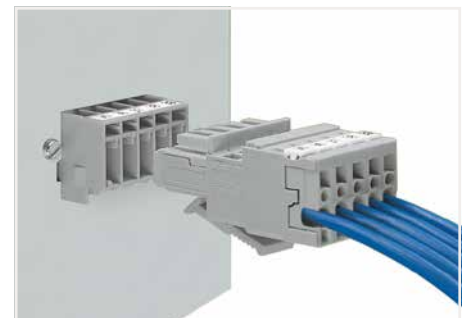

Male header with mounting flanges
1-conductor female plug with bottom-mount locking levers

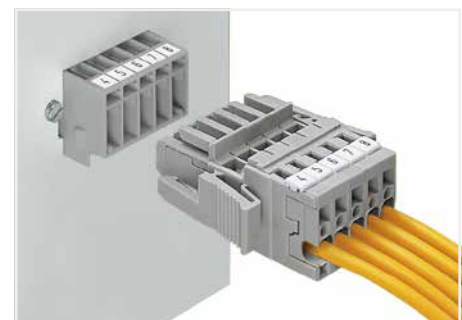

Male header and 1-conductor female plug with lateral locking levers

Male Header X-COM®-SYSTEM; with Solder Pins and Feedthrough Flanges; 5 mm Pin Spacing 769 Series

Technical Data

Pin spacing: 5 mm / 0.197 inch

250 V/4 kV/3 ① | 300 V, 20 A^{RA}

500 V/4 kV/3 ① | 300 V, 20 A[@]

I_N 32 A ②

Technical Data

Pin spacing: 5 mm / 0.197 inch

250 V/4 kV/3 ① | 300 V, 20 A^{RA}

500 V/4 kV/3 ① | 300 V, 20 A[@]

I_N 32 A ②

- ① 250 V / 500 V = rated voltage
4 kV = rated impulse voltage
3 = pollution degree
(see Section 15)

- ② Current-carrying capacity curve on page 456 and upon request

Approvals and corresponding ratings, visit www.wago.com



Dimensions (in mm)

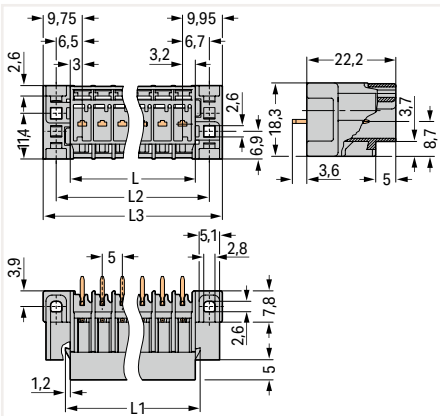

L1 = L + 2.4 mm, L2 = L + 7 mm, L3 = L + 13.5 mm
L = (pole no. - 1) x pin spacing + 6.2 mm

Dimensions (in mm)

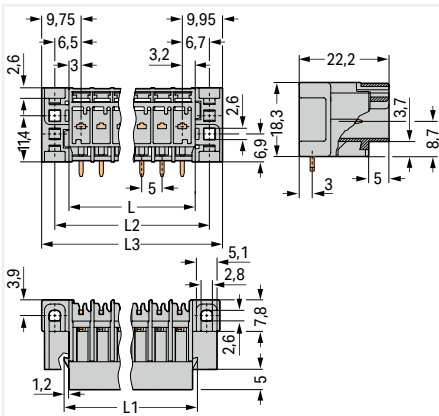

L1 = L + 2.4 mm, L2 = L + 7 mm, L3 = L + 13.5 mm
L = (pole no. - 1) x pin spacing + 6.2 mm

Male header; with straight solder pins and feedthrough flanges; 1 x 1 mm; Vertical mating direction to the PCB; gray

Pole No.	Item No.	Pack. Unit
2	769-632/004-000	200
3	769-633/004-000	50
4	769-634/004-000	50
5	769-635/004-000	50
6	769-636/004-000	50
7	769-637/004-000	25
8	769-638/004-000	25
9	769-639/004-000	25
10	769-640/004-000	25
11	769-641/004-000	25
12	769-642/004-000	25
13	769-643/004-000	15
14	769-644/004-000	15
15	769-645/004-000	15

Male header; with angled solder pins and feedthrough flanges; 1 x 1 mm; Horizontal mating direction to the PCB; gray

Pole No.	Item No.	Pack. Unit
2	769-662/004-000	200
3	769-663/004-000	100
4	769-664/004-000	50
5	769-665/004-000	50
6	769-666/004-000	50
7	769-667/004-000	50
8	769-668/004-000	25
9	769-669/004-000	25
10	769-670/004-000	25
11	769-671/004-000	25
12	769-672/004-000	25
13	769-673/004-000	25
14	769-674/004-000	15
15	769-675/004-000	15

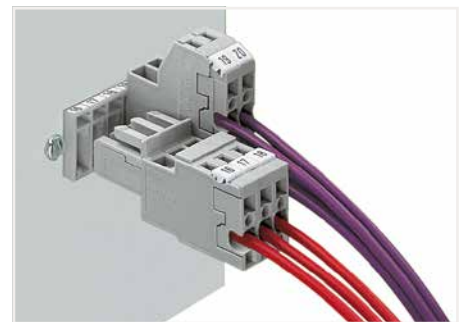

Male header; with feedthrough flanges
1-conductor female plug
2-conductor female plug

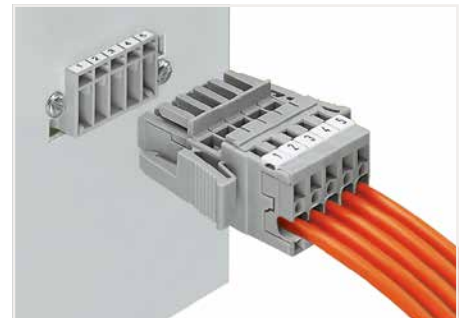

Male header and 1-conductor female plug with lateral locking levers

Accessories; for male connectors

1-conductor female plug; straight

	gray	769-102	100
--	------	---------	-----

1-conductor female plug; with lateral locking levers

	gray	769-102/021-000	50
--	------	-----------------	----

Coding pin; for coding female plugs

	orange	769-435	100 (25)
--	--------	---------	----------

Male Headers X-COM®-SYSTEM; with Solder Pins; with 1-/2-Conductor Female Plugs Assembly Types

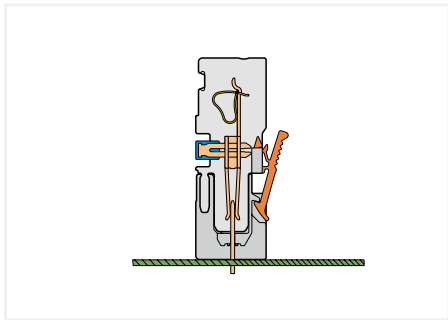

Male header; with straight solder pins

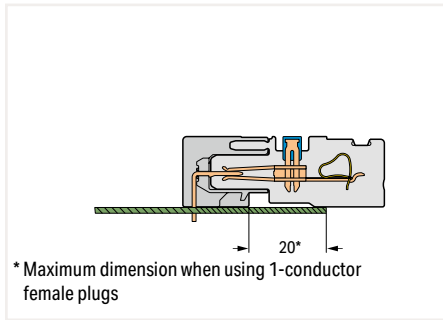

* Maximum dimension when using 1-conductor female plugs

Male header; with angled solder pins

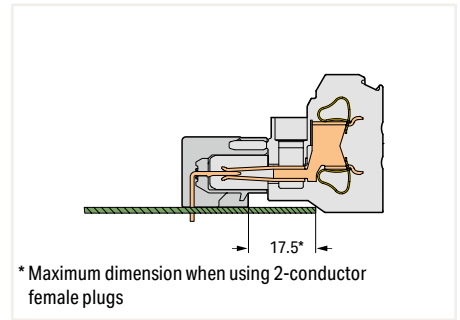

* Maximum dimension when using 2-conductor female plugs

Male header; with angled solder pins

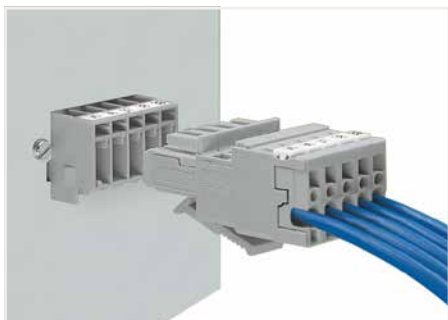

Male header; with mounting flanges
1-conductor female plug; with bottom-mount locking levers

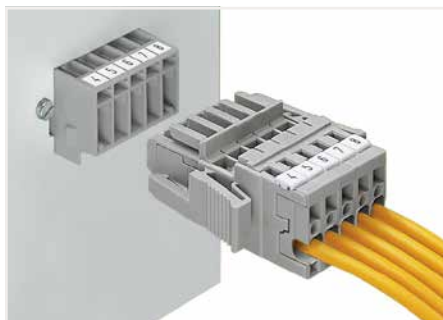

Male header; with mounting flanges
1-conductor female plug; with lateral locking levers

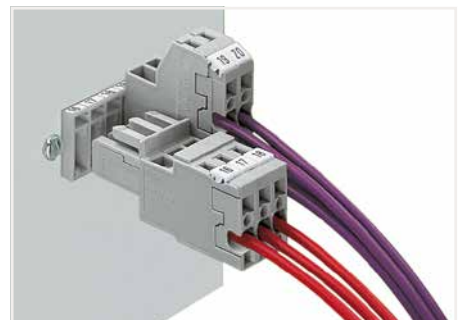

Male header; with feedthrough flanges
1-conductor female plug
2-conductor female plug

7

Cutouts for headers with fixing flanges for feedthrough applications and locking levers

Female plugs with bottom-mounted locking levers

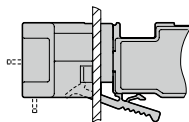

Cutouts for 2-pole locking levers (2- to 15-pole female plugs)

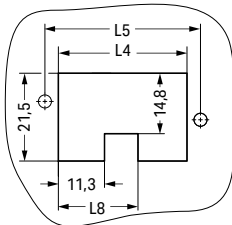

Layout for locking levers outer ...

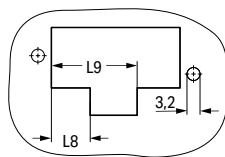

... inner

Cutouts for single pole locking levers

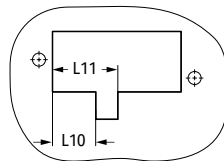
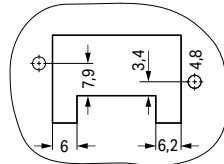

Female plug without locking levers

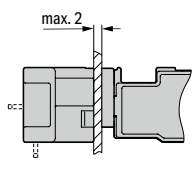
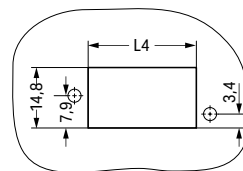

Female plug with lateral locking levers

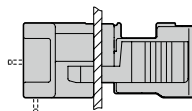
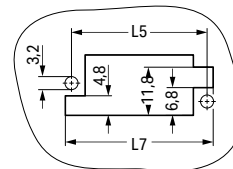

- L 4 = pole no. x pin spacing + 1.7 mm
- L 5 = L 4 + 6.6 mm
- L 7 = L 4 + 9.4 mm
- L 8 = pole no. LL x pin spacing - 0.3 mm
- L 9 = L 8 + 11.6 mm
- L 10 = pole no. LL x pin spacing + 0.6 mm
- L 11 = L 10 + 5.4 mm
- Pole no. LL: Number of poles ahead of the poles attached to the locking lever
- LL = locking lever

Male Header X-COM®-SYSTEM; with Solder Pins and Rivet Mounting Flanges; 5 mm Pin Spacing 769 Series

Technical Data

Pin spacing: 5 mm / 0.197 inch

250 V/4 kW/3 ①

500 V/4 kW/3 ①

I_N 32 A ②

① 250 V / 500 V = rated voltage
4 kV = rated impulse voltage
3 = pollution degree
(see Section 15)

② Current-carrying capacity curves upon request

Approvals and corresponding ratings,
visit www.wago.com



Mounting with 3 mm Ø blind rivets

Dimensions (in mm)

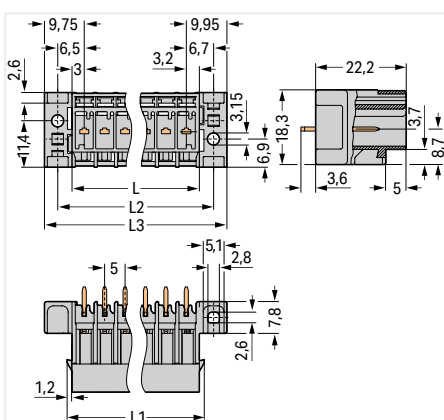

L1 = L + 2.4 mm, L2 = L + 7 mm, L3 = L + 13.5 mm
L = (pole no. - 1) x pin spacing + 6.2 mm

Male header; with straight solder pins and rivet mounting flanges; 1 x 1 mm; Vertical mating direction to the PCB; gray

Pole No.	Item No.	Pack. Unit
2	769-632/007-000	200
3	769-633/007-000	50
4	769-634/007-000	50
5	769-635/007-000	50
6	769-636/007-000	50
7	769-637/007-000	25
8	769-638/007-000	25
9	769-639/007-000	25
10	769-640/007-000	25
11	769-641/007-000	25
12	769-642/007-000	25
13	769-643/007-000	15
14	769-644/007-000	15
15	769-645/007-000	15

Accessories; for male connectors

1-conductor female plug; straight

	gray	769-102	100
---	------	---------	-----

1-conductor female plug; with lateral locking levers

	gray	769-102/021-000	50
---	------	-----------------	----

Coding pin; for coding female plugs

	orange	769-435	100 (25)
--	--------	---------	----------

1-Conductor Female Plug X-COM®-SYSTEM

4 mm²; 769 Series

Technical Data	
0.08 ... 4 mm ²	28 ... 12 AWG
500 V/6 kV/3 ①	300 V, 20 A
I _N 32 A ②	300 V, 20 A @
Module width: 5 mm / 0.197 inch	
8 ... 9 mm / 0.31 ... 0.35 inch	



Dimensions (in mm)

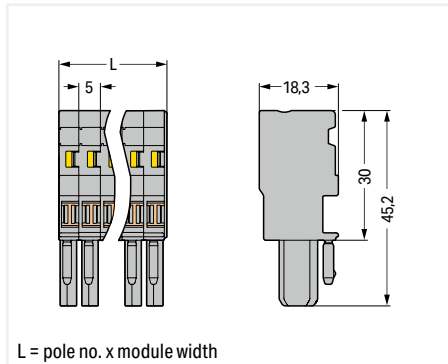

1-conductor female plug; straight; fits into carrier terminal blocks or male connectors; with coding fingers; can be commoned with miniature adjacent jumpers; gray

Pole No.	Item No.	Pack. Unit
○ 1	769-101	200
○ 2	769-102	100
○ 3	769-103	50
○ 4	769-104	50
○ 5	769-105	50
○ 6	769-106	25
○ 7	769-107	25
○ 8	769-108	25
○ 9	769-109	25
○ 10	769-110	25
○ 11	769-111	20
○ 12	769-112	20
○ 13	769-113	10
○ 14	769-114	10
○ 15	769-115	10

1-conductor female plug; straight; fits into carrier terminal blocks or male connectors; with coding fingers; can be commoned with miniature adjacent jumpers

● 1 blue	769-101/000-006	200
● 1 green-yellow	769-101/000-016	200

- 500 V = rated voltage
6 kV = rated impulse voltage
3 = pollution degree
(see Section 15)
 - Current-carrying capacity curve from page 453 and upon request
- Item no. suffixes
blue .../000-006
- Snap-on type strain relief housing, see page 452
- Note:**
According to EN 61984, pluggable connectors without a current interrupting capacity must not be mated or unmated when live or under load.
- Approvals and corresponding ratings, visit www.wago.com

Accessories; for female plugs
Appropriate marking systems:
Mini-WSB/Mini-WSB Inline

Insulation stop; 0.08 ... 0.2 mm² "s" (0.14 mm² "f-st"); 5 pcs/strip

	white	769-470	200 (25)
--	-------	---------	----------

Insulation stop; 0.25 ... 0.5 mm²; 5 pcs/strip

	light gray	769-471	200 (25)
--	------------	---------	----------

Insulation stop; 0.75 ... 1 mm²; 5 pcs/strip

	dark gray	769-472	200 (25)
--	-----------	---------	----------

Protective warning marker; with black high-voltage symbol; for 5 terminal blocks

	yellow	280-415	100 (25)
--	--------	---------	----------

Adjacent jumper; insulated; I_N 24 A

	gray	769-402	100 (25)
--	------	---------	----------

Jumper cover; for 1-conductor female plugs; for 5 poles

	gray	769-436	100 (25)
--	------	---------	----------

Operating lever; loose; for male and female connectors with CAGE CLAMP® connection

		769-434	2000 (100)
--	--	---------	------------

Locking Lever; for 1-pole female plugs

	gray	769-428	100 (25)
	orange	769-429	100 (25)

Locking lever; for female plugs with 2 poles and more

	gray	769-431	100 (25)
	orange	769-430	100 (25)

Strain relief plate; gray

	1-pole	769-410	100 (25)
	2- ... 3-pole	769-411	100 (25)
	4- ... 5-pole	769-412	100 (25)

Strain relief plate; gray

	6- ... 9-pole	769-413	100 (25)
	10- ... 15-pole	769-414	100 (25)

Accessories; for female plugs

Appropriate marking systems:
Mini-WSB/Mini-WSB Inline

Snap-on type strain relief housing; consists of strain relief support and housing

	5-pole	769-1605	25
--	--------	----------	----

Mini-WSB Inline, plain; 1,700 WMB markers (5 mm)/reel; 5 ... 5.2 mm stretchable

	white	2009-145	1
--	-------	----------	---

Mini-WSB marking card; white; 10 strips with 10 markers/card; 5 mm wide markers

	plain	248-501	5
--	-------	---------	---



1-pole female plug
Application examples:

- Phase selection in three-phase network
- Test plug with rated current capability
- Simplified circuit expansion – addition of base circuits requires only female plugs to be plugged in

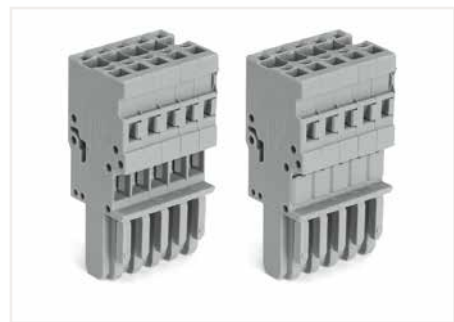

Jumper cover for 1-conductor female plugs

1-Conductor Female Plug X-COM®-SYSTEM; with Lateral Locking Levers

4 mm²; 769 Series

Technical Data

0.08 ... 4 mm ²	28 ... 12 AWG
500 V/6 kW/3 ①	300 V, 20 A
I _N 32 A ②	300 V, 20 A @
Module width: 5 mm / 0.197 inch	
8 ... 9 mm / 0.31 ... 0.35 inch	



Dimensions (in mm)

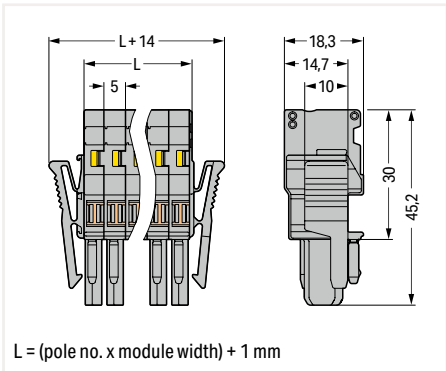

1-conductor female plug; with lateral locking levers; only compatible with male connectors; codable; can be commoned with miniature adjacent jumpers; gray

Pole No.	Item No.	Pack. Unit
2	769-102/021-000	200
3	769-103/021-000	50
4	769-104/021-000	50
5	769-105/021-000	50
6	769-106/021-000	50
7	769-107/021-000	25
8	769-108/021-000	25
9	769-109/021-000	25
10	769-110/021-000	25
11	769-111/021-000	25
12	769-112/021-000	25
13	769-113/021-000	15
14	769-114/021-000	15
15	769-115/021-000	15

- ① 500 V = rated voltage
6 kV = rated impulse voltage
3 = pollution degree (see Section 15)
- ② Current-carrying capacity curve from page 455 and upon request

Snap-on type strain relief housing, see page 452

Note:
According to EN 61984, pluggable connectors without a current interrupting capacity must not be mated or unmated when live or under load.

Approvals and corresponding ratings, visit www.wago.com

Accessories; for female plugs

Appropriate marking systems:
Mini-WSB/Mini-WSB Inline

Insulation stop; 0.08 ... 0.2 mm² "s" (0.14 mm² "f-st"); 5 pcs/strip

white	769-470	200 (25)
-------	---------	----------

Insulation stop; 0.25 ... 0.5 mm²; 5 pcs/strip

light gray	769-471	200 (25)
------------	---------	----------

Insulation stop; 0.75 ... 1 mm²; 5 pcs/strip

dark gray	769-472	200 (25)
-----------	---------	----------

Protective warning marker; with black high-voltage symbol; for 5 terminal blocks

yellow	280-415	100 (25)
--------	---------	----------

Adjacent jumper; insulated; I_N 24 A

gray	769-402	100 (25)
------	---------	----------

Jumper cover; for 1-conductor female plugs; for 5 poles

gray	769-436	100 (25)
------	---------	----------

Operating lever; loose; for male and female connectors with CAGE CLAMP® connection

gray	769-434	2000 (100)
------	---------	------------

Strain relief plate; gray

2- ... 3-pole	769-411	100 (25)
4- ... 5-pole	769-412	100 (25)

Strain relief plate; gray

6- ... 9-pole	769-413	100 (25)
10- ... 15-pole	769-414	100 (25)

Snap-on type strain relief housing; consists of strain relief support and housing

5-pole	769-1605	25
--------	----------	----

Accessories; for female plugs

Appropriate marking systems:
Mini-WSB/Mini-WSB Inline

Mini-WSB Inline, plain; 1,700 WMB markers (5 mm)/reel; 5 ... 5.2 mm stretchable

white	2009-145	1
-------	----------	---

Mini-WSB marking card; white; 10 strips with 10 markers/card; 5 mm wide markers

plain	248-501	5
-------	---------	---

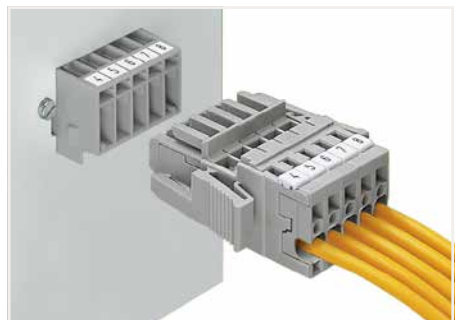

Male header; with mounting flanges
1-conductor female plug with lateral locking levers

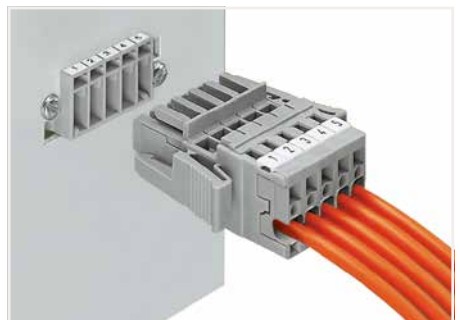

Male header and 1-conductor female plug with lateral locking levers

7

2-Conductor Female Plug X-COM®-SYSTEM 4 mm²; 769 Series

Technical Data

0.08 ... 4 mm ²	28 ... 12 AWG
500 V/6 kV/3 ①	300 V, 20 A ②
I _N 32 A ②	300 V, 20 A ②
Module width: 5 mm / 0.197 inch	
8 ... 9 mm / 0.31 ... 0.35 inch	

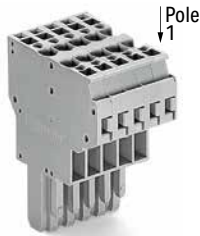

Dimensions (in mm)

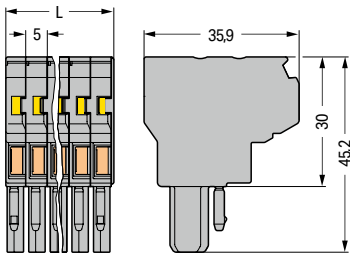

L = pole no. x module width

2-conductor female plug; fits into carrier terminal blocks or male connectors; codable; can be commoned with adjacent and staggered jumpers; gray

Pole No.	Item No.	Pack. Unit
1	769-121	100
2	769-122	50
3	769-123	25
4	769-124	25
5	769-125	20
6	769-126	10
7	769-127	10
8	769-128	10
9	769-129	10
10	769-130	10
11	769-131	5
12	769-132	5
13	769-133	5
14	769-134	5
15	769-135	5

2-conductor female plug; fits into carrier terminal blocks or male connectors; codable; can be commoned with adjacent and staggered jumpers

1 green-yellow	769-121/000-016	100
----------------	-----------------	-----

- ① 500 V = rated voltage
6 kV = rated impulse voltage
3 = pollution degree
(see Section 15)
- ② Current-carrying capacity curves upon request

Please observe the application notes:
Jumpers, from page 384

Note:
According to EN 61984, pluggable connectors without a current interrupting capacity must not be mated or unmated when live or under load.

Approvals and corresponding ratings,
visit www.wago.com

Accessories; for female plugs

Appropriate marking systems:
Mini-WSB/Mini-WSB Inline

Insulation stop; 0.08 ... 0.2 mm² "s" (0.14 mm² "f-st"); 5 pcs/strip

white	769-470	200 (25)
-------	---------	----------



Insulation stop; 0.25 ... 0.5 mm²; 5 pcs/strip

light gray	769-471	200 (25)
------------	---------	----------



Insulation stop; 0.75 ... 1 mm²; 5 pcs/strip

dark gray	769-472	200 (25)
-----------	---------	----------



Protective warning marker; with black high-voltage symbol; for 5 terminal blocks

yellow	280-415	100 (25)
--------	---------	----------



Adjacent jumper; insulated; I_N = I_N terminal block

gray	280-402	200 (25)
------	---------	----------



Staggered jumper; insulated; 5 mm wide; I_N 24 A

1 to 2	780-452	100 (25)
1 to 3	780-453	100 (25)
1 to 4	780-454	100 (25)
1 to 5	780-455	50 (25)
1 to 6	780-456	50 (25)
1 to 7	780-457	50 (25)
1 to 8	780-458	50 (25)

Locking Lever; for 1-pole female plugs

gray	769-428	100 (25)
orange	769-429	100 (25)



Locking lever; for female plugs with 2 poles and more

gray	769-431	100 (25)
orange	769-430	100 (25)



Strain relief plate; gray

1-pole	769-410	100 (25)
2- ... 3-pole	769-411	100 (25)
4- ... 5-pole	769-412	100 (25)



Strain relief plate; gray

6- ... 9-pole	769-413	100 (25)
10- ... 15-pole	769-414	100 (25)



Accessories; for female plugs

Appropriate marking systems:
Mini-WSB/Mini-WSB Inline

Mini-WSB Inline, plain; 1,700 WMB markers (5 mm)/reel; 5 ... 5.2 mm stretchable

white	2009-145	1
-------	----------	---



Mini-WSB marking card; white; 10 strips with 10 markers/card; 5 mm wide markers

plain	248-501	5
-------	---------	---

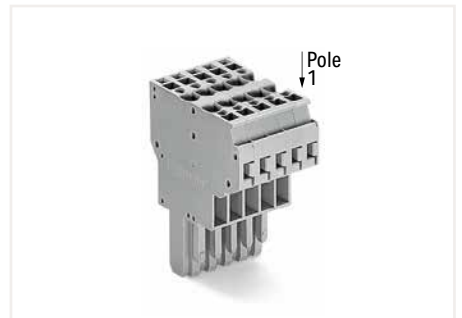

2-conductor female plugs:

- Common signals from one subassembly to the other (bus structure)
- Can be used as a T-wire branch tap connection (e.g. for lighting wiring)
- Enable a higher number of connection possibilities

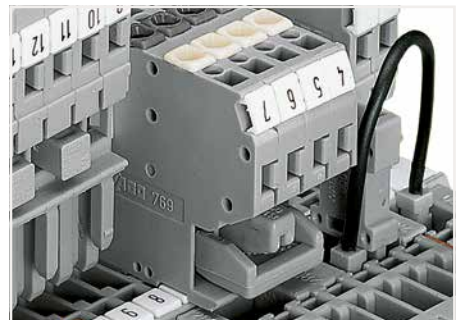

Commoning options of female plugs:

- After removal, commoned potentials still remain commoned
- Use of plug-in jumpers instead of additional wired jumpers
- Can be used as a "hardware" key for safety lockout
- Can also be used as a commoning jumper for sensor circuits or machine programming

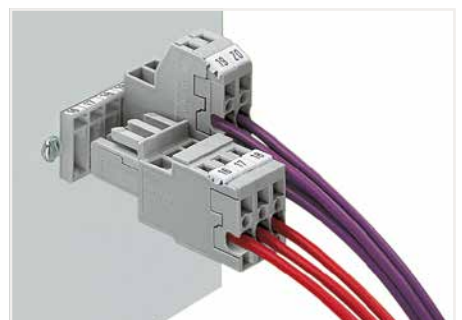

Male header; with feedthrough flanges
1-conductor female plug
2-conductor female plug

7

1-Conductor Female Plug X-COM®-SYSTEM; Angled 4 mm²; 769 Series

Technical Data	
0.08 ... 4 mm ²	28 ... 12 AWG
500 V/6 kV/3 ①	300 V, 20 A ②
I _N 32 A ②	300 V, 20 A ②
Module width: 5 mm / 0.197 inch	
8 ... 9 mm / 0.31 ... 0.35 inch	



Dimensions (in mm)

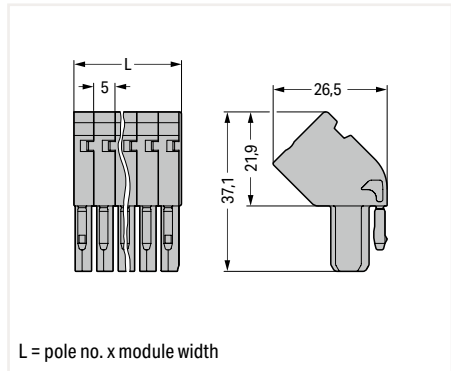

1-conductor female plug; angled; fits into carrier terminal blocks; codable; gray

Pole No.	Item No.	Pack. Unit
○ 1	769-101/022-000	200
○ 2	769-102/022-000	100
○ 3	769-103/022-000	50
○ 4	769-104/022-000	50
○ 5	769-105/022-000	50
○ 6	769-106/022-000	25
○ 7	769-107/022-000	25
○ 8	769-108/022-000	25
○ 9	769-109/022-000	25
○ 10	769-110/022-000	25
○ 11	769-111/022-000	20
○ 12	769-112/022-000	20
○ 13	769-113/022-000	10
○ 14	769-114/022-000	10
○ 15	769-115/022-000	10

1-conductor female plug; angled; fits into carrier terminal blocks; codable		
● 1 green-yellow	769-101/022-016	200

- ① 500 V = rated voltage
6 kV = rated impulse voltage
3 = pollution degree
(see Section 15)
- ② Current-carrying capacity curves upon request

Note:
According to EN 61984, pluggable connectors without a current interrupting capacity must not be mated or unmated when live or under load.

Approvals and corresponding ratings, visit www.wago.com

Accessories; for female plugs
Appropriate marking systems:
Mini-WSB/Mini-WSB Inline

Insulation stop; 0.08 ... 0.2 mm² "s" (0.14 mm² "f-st"); 5 pcs/strip

white	769-470	200 (25)
-------	---------	----------

Insulation stop; 0.25 ... 0.5 mm²; 5 pcs/strip

light gray	769-471	200 (25)
------------	---------	----------

Insulation stop; 0.75 ... 1 mm²; 5 pcs/strip

dark gray	769-472	200 (25)
-----------	---------	----------

Protective warning marker; with black high-voltage symbol; for 5 terminal blocks

yellow	280-415	100 (25)
--------	---------	----------

Operating lever; loose; for male and female connectors with CAGE CLAMP® connection

	769-434	2000 (100)
--	---------	------------

Test plug; with 500 mm cable; 2 mm Ø; max. 42 V

red	210-136	50
-----	---------	----

Strain relief plate; gray

1-pole	769-410	100 (25)
2- ... 3-pole	769-411	100 (25)
4- ... 5-pole	769-412	100 (25)

Strain relief plate; gray

6- ... 9-pole	769-413	100 (25)
10- ... 15-pole	769-414	100 (25)

Snap-on type strain relief housing; consists of strain relief support and housing

5-pole	769-1605	25
--------	----------	----

Accessories; for female plugs

Appropriate marking systems:
Mini-WSB/Mini-WSB Inline

Mini-WSB Inline, plain; 1,700 WMB markers (5 mm)/reel; 5 ... 5.2 mm stretchable

white	2009-145	1
-------	----------	---

Mini-WSB marking card; white; 10 strips with 10 markers/card; 5 mm wide markers

plain	248-501	5
-------	---------	---

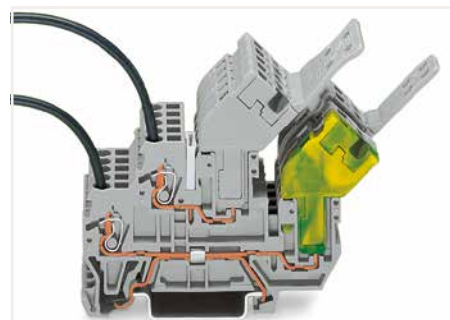

Angled female plugs provide reduced installation height.



1-conductor/1-pin double-deck carrier terminal block
1-conductor female plug, angled*
*1-conductor straight female plug is also possible!

Female Plug for Self-Assembly X-COM®-SYSTEM

4 mm²; 769 Series

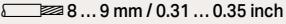
Technical Data	
0.08 ... 4 mm ²	28 ... 12 AWG
500 V/6 kV/3 ①	
I _N 32 A ②	
Terminal block width: 5 mm / 0.197 inch	
 8 ... 9 mm / 0.31 ... 0.35 inch	

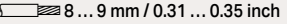

Technical Data	
0.08 ... 4 mm ²	28 ... 12 AWG
500 V/6 kV/3 ①	
I _N 32 A ②	
Terminal block width: 5 mm / 0.197 inch	
 8 ... 9 mm / 0.31 ... 0.35 inch	

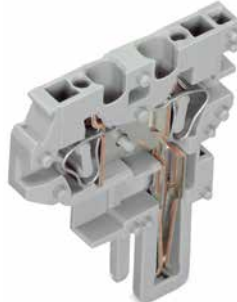

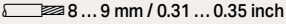
Technical Data	
0.08 ... 4 mm ²	28 ... 12 AWG
500 V/6 kV/3 ①	
I _N 32 A ②	
Terminal block width: 5 mm / 0.197 inch	
 8 ... 9 mm / 0.31 ... 0.35 inch	



1-conductor end module; codable; can be commoned with miniature adjacent jumpers		
Color	Item No.	Pack. Unit
gray	769-503	250
blue	769-503/000-006	250
green-yellow	769-503/000-016	250

2-conductor end module; codable; can be commoned with adjacent and staggered jumpers		
Color	Item No.	Pack. Unit
gray	769-506	250
blue	769-506/000-006	250
green-yellow	769-506/000-016	250

1-conductor end module; angled; codable		
Color	Item No.	Pack. Unit
gray	769-515	250
blue	769-515/000-006	250
green-yellow	769-515/000-016	250

1-conductor center module; codable; can be commoned with miniature adjacent jumpers		
Color	Item No.	Pack. Unit
gray	769-502	250
blue	769-502/000-006	250
green-yellow	769-502/000-016	250

2-conductor center module; codable; can be commoned with adjacent and staggered jumpers		
Color	Item No.	Pack. Unit
gray	769-505	250
blue	769-505/000-006	250
green-yellow	769-505/000-016	250

1-conductor center module; angled; codable		
Color	Item No.	Pack. Unit
gray	769-513	250
blue	769-513/000-006	250
green-yellow	769-513/000-016	250

1-conductor base module; with integrated end plate; codable; can be commoned with miniature adjacent jumpers		
Color	Item No.	Pack. Unit
gray	769-501	250
blue	769-501/000-006	250
green-yellow	769-501/000-016	250

2-conductor base module; with integrated end plate; codable; can be commoned with adjacent and staggered jumpers		
Color	Item No.	Pack. Unit
gray	769-504	250
blue	769-504/000-006	250
green-yellow	769-504/000-016	250

1-conductor base module; angled; with integrated end plate; codable		
Color	Item No.	Pack. Unit
gray	769-512	250
blue	769-512/000-006	250
green-yellow	769-512/000-016	250

Accessories; item-specific			
Adjacent jumper; insulated; I _N 24 A			
Color	Item No.	Pack. Unit	Image
gray	769-402	100 (25)	

Accessories; item-specific			
Adjacent jumper; insulated; I _N = I _N terminal block			
Color	Item No.	Pack. Unit	Image
gray	280-402	200 (25)	

Locking Lever; for 1-pole female plugs			
Color	Item No.	Pack. Unit	Image
gray	769-428	100 (25)	
orange	769-429	100 (25)	

Locking Lever; for 1-pole female plugs			
Color	Item No.	Pack. Unit	Image
gray	769-428	100 (25)	
orange	769-429	100 (25)	

Locking lever; for female plugs with 2 poles and more			
Color	Item No.	Pack. Unit	Image
gray	769-431	100 (25)	
orange	769-430	100 (25)	

Locking lever; for female plugs with 2 poles and more			
Color	Item No.	Pack. Unit	Image
gray	769-431	100 (25)	
orange	769-430	100 (25)	

Accessories; for female plugs

Insulation stop; 0.08 ... 0.2 mm ² "s" (0.14 mm ² "f-st"); 5 pcs/strip			
Color	Item No.	Pack. Unit	Image
white	769-470	200 (25)	

Appropriate marking systems: Mini-WSB/Mini-WSB Inline			
Protective warning marker; with black high-voltage symbol; for 5 terminal blocks			
Color	Item No.	Pack. Unit	Image
yellow	280-415	100 (25)	

Strain relief plate; gray			
Poles	Item No.	Pack. Unit	Image
1-pole	769-410	100 (25)	
2- ... 3-pole	769-411	100 (25)	
4- ... 5-pole	769-412	100 (25)	

Insulation stop; 0.25 ... 0.5 mm ² ; 5 pcs/strip			
Color	Item No.	Pack. Unit	Image
light gray	769-471	200 (25)	

Operating lever; loose; for male and female connectors with CAGE CLAMP® connection			
Color	Item No.	Pack. Unit	Image
	769-434	2000 (100)	

Strain relief plate; gray			
Poles	Item No.	Pack. Unit	Image
6- ... 9-pole	769-413	100 (25)	
10- ... 15-pole	769-414	100 (25)	

Insulation stop; 0.75 ... 1 mm ² ; 5 pcs/strip			
Color	Item No.	Pack. Unit	Image
dark gray	769-472	200 (25)	

Test plug; with 500 mm cable; 2 mm Ø; max. 42 V			
Color	Item No.	Pack. Unit	Image
red	210-136	50	

7

- ❶ 500 V = rated voltage
6 kV = rated impulse voltage
3 = pollution degree
(see Section 15)
 - ❷ Current-carrying capacity curves upon request
- Note:**
According to EN 61984, pluggable connectors without a current interrupting capacity must not be mated or unmated when live or under load.
- Approvals and corresponding ratings, visit www.wago.com

Customizing Modular Female Plugs
WAGO's modular X-COM®-SYSTEM female plugs can be customized for applications requiring varying numbers of poles (e.g., when designing prototypes).

- Modules and Pole Numbers**
A customized X-COM®-SYSTEM female plug consists of:
- One base module with an integrated end plate
 - Up to 13 center modules (corresponding to a 15-pole female plug = maximum pole number)
 - One end module

Intended Use
According to EN 61984, pluggable connectors without a current interrupting capacity must not be mated or unmated when live or under load.

Assembly
The appropriate mounting tool shall be used in order to guarantee that the individual modules are properly attached to each other without damaging the locking latches.

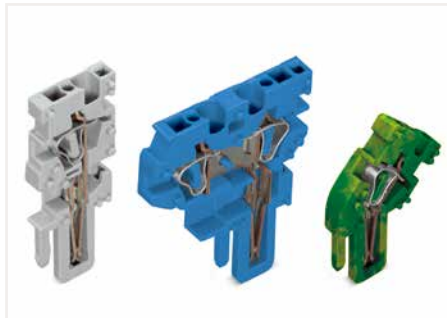

End module



Center module



Base module

Example: 5-Pole, 1-Conductor Female Plug

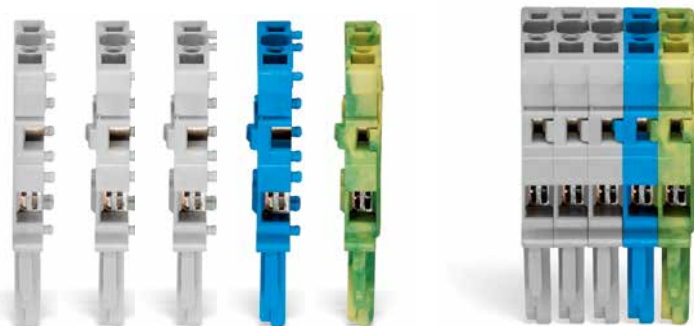

- Base module with integrated end plate
769-501/000-016
- Center module
769-502/000-006
- Center modules
769-502
- End module
769-503

Pre-Assembled 1-Conductor Female Plug X-COM®-SYSTEM 4 mm²; 769 Series

Technical Data	
0.08 ... 4 mm ²	28 ... 12 AWG
500 V/6 kV/3 ①	
I _N 32 A ②	
Module width: 5 mm / 0.197 inch	
8 ... 9 mm / 0.31 ... 0.35 inch	



Technical Data	
0.08 ... 4 mm ²	28 ... 12 AWG
500 V/6 kV/3 ①	
I _N 32 A ②	
Module width: 5 mm / 0.197 inch	
8 ... 9 mm / 0.31 ... 0.35 inch	



Technical Data	
0.08 ... 4 mm ²	28 ... 12 AWG
500 V/6 kV/3 ①	
I _N 32 A ②	
Module width: 5 mm / 0.197 inch	
8 ... 9 mm / 0.31 ... 0.35 inch	



1-conductor female plug; with ground base module (green-yellow); fits into carrier terminal blocks or male connectors; codable; can be commoned with miniature adjacent jumpers

Pole No.	Item No.	Pack. Unit
3	769-103/000-036	25
4	769-104/000-036	25
5	769-105/000-036	20
6	769-106/000-036	10
7	769-107/000-036	10
8	769-108/000-036	10
9	769-109/000-036	10
10	769-110/000-036	10
11	769-111/000-036	5
12	769-112/000-036	5
13	769-113/000-036	5
14	769-114/000-036	5
15	769-115/000-036	5

1-conductor female plug; with ground end module (green-yellow); fits into carrier terminal blocks or male connectors; codable; can be commoned with miniature adjacent jumpers

Pole No.	Item No.	Pack. Unit
3	769-103/000-037	25
4	769-104/000-037	25
5	769-105/000-037	20
6	769-106/000-037	10
7	769-107/000-037	10
8	769-108/000-037	10
9	769-109/000-037	10
10	769-110/000-037	10
11	769-111/000-037	5
12	769-112/000-037	5
13	769-113/000-037	5
14	769-114/000-037	5
15	769-115/000-037	5

1-conductor female plug; with ground base module (green-yellow); fits into carrier terminal blocks or male connectors; codable; can be commoned with miniature adjacent jumpers

Pole No.	Item No.	Pack. Unit
3	769-103/000-038	25
4	769-104/000-038	25
5	769-105/000-038	20
6	769-106/000-038	10
7	769-107/000-038	10
8	769-108/000-038	10
9	769-109/000-038	10
10	769-110/000-038	10
11	769-111/000-038	5
12	769-112/000-038	5
13	769-113/000-038	5
14	769-114/000-038	5
15	769-115/000-038	5

Accessories; for female plugs

Insulation stop; 0.08 ... 0.2 mm² "s" (0.14 mm² "f-st"); 5 pcs/strip

white	769-470	200 (25)
-------	---------	----------

Insulation stop; 0.25 ... 0.5 mm²; 5 pcs/strip

light gray	769-471	200 (25)
------------	---------	----------

Insulation stop; 0.75 ... 1 mm²; 5 pcs/strip

dark gray	769-472	200 (25)
-----------	---------	----------

Protective warning marker; with black high-voltage symbol; for 5 terminal blocks

yellow	280-415	100 (25)
--------	---------	----------

Adjacent jumper; insulated; I_N 24 A

gray	769-402	100 (25)
------	---------	----------

Jumper cover; for 1-conductor female plugs; for 5 poles

gray	769-436	100 (25)
------	---------	----------

Appropriate marking systems: Mini-WSB/Mini-WSB Inline

Test plug; with 500 mm cable; 2 mm Ø; max. 42 V

red	210-136	50
-----	---------	----

Strain relief plate; gray

2- ... 3-pole	769-411	100 (25)
4- ... 5-pole	769-412	100 (25)

Strain relief plate; gray

6- ... 9-pole	769-413	100 (25)
10- ... 15-pole	769-414	100 (25)

Snap-on type strain relief housing; consists of strain relief support and housing

5-pole	769-1605	25
--------	----------	----

Operating lever; loose; for male and female connectors with CAGE CLAMP® connection

	769-434	2000 (100)
--	---------	------------

Mini-WSB Inline, plain; 1,700 WMB markers (5 mm)/reel; 5 ... 5.2 mm stretchable

white	2009-145	1
-------	----------	---

Mini-WSB marking card; white; 10 strips with 10 markers/card; 5 mm wide markers

plain	248-501	5
-------	---------	---

7

Technical Data0.08 ... 4 mm² | 28 ... 12 AWG

500 V/6 kV/3 ①

I_N 32 A ②

Module width: 5 mm / 0.197 inch

8 ... 9 mm / 0.31 ... 0.35 inch



① 500 V = rated voltage
6 kV = rated impulse voltage
3 = pollution degree
(see Section 15)

② Current-carrying capacity curves upon request

Snap-on type strain relief housing, see page 452

Note:

According to EN 61984, pluggable connectors without a current interrupting capacity must not be mated or unmated when live or under load.

Approvals and corresponding ratings, visit www.wago.com

1-conductor female plug; with ground end module (green-yellow); fits into carrier terminal blocks or male connectors; codable; can be commoned with miniature adjacent jumpers

Pole No.	Item No.	Pack. Unit
3	769-103/000-039	25
4	769-104/000-039	25
5	769-105/000-039	20
6	769-106/000-039	10
7	769-107/000-039	10
8	769-108/000-039	10
9	769-109/000-039	10
10	769-110/000-039	510
11	769-111/000-039	5
12	769-112/000-039	5
13	769-113/000-039	5
14	769-114/000-039	5
15	769-115/000-039	5

Strain Relief Housing X-COM®-SYSTEM; for Female Plugs and Male Connectors with CAGE CLAMP® Connection 769 Series

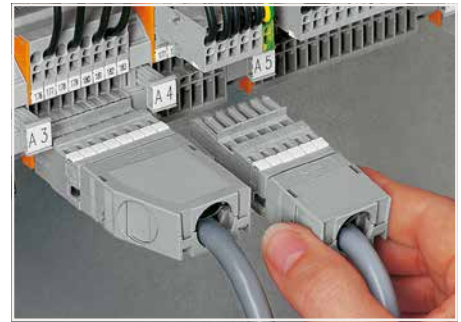
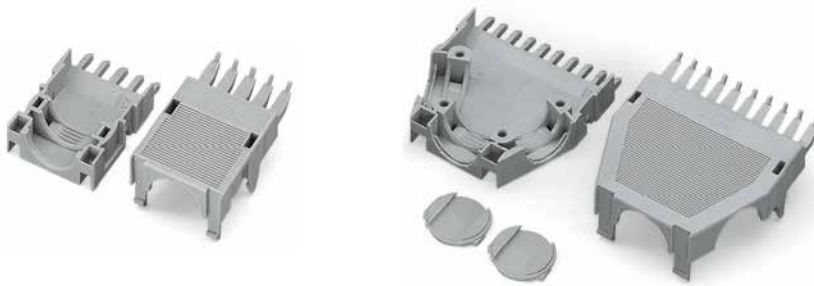

Dimensions (in mm)

Application:
Strain relief housings for 769 Series

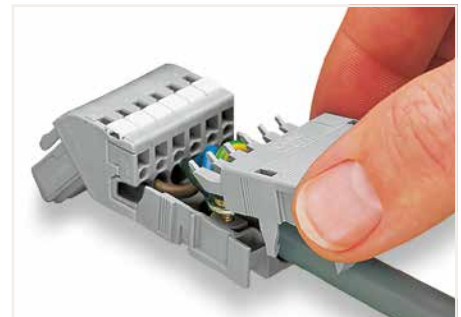
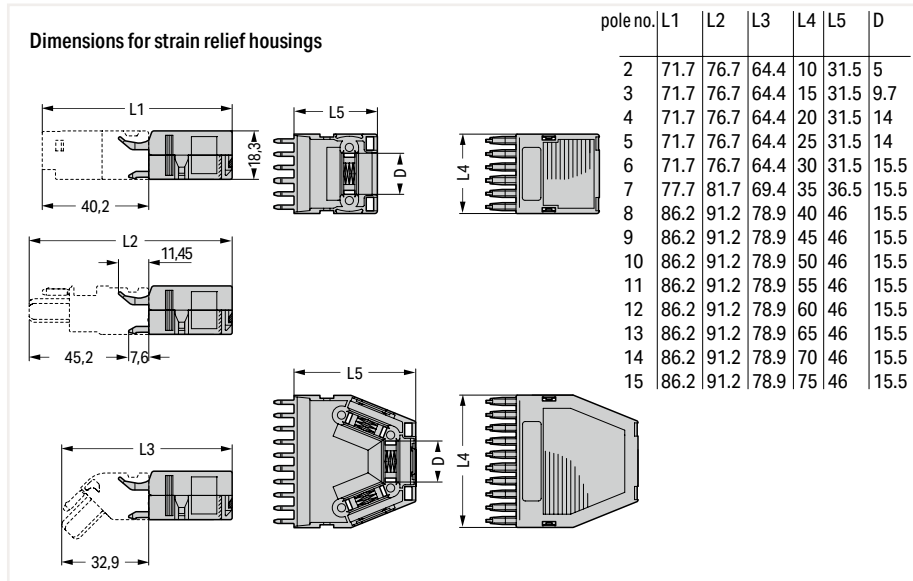

Snapping on a strain relief housing.



Strain relief housing; consists of strain relief support and housing; 6-pole and 1-conductor female plug; angled; 6-pole

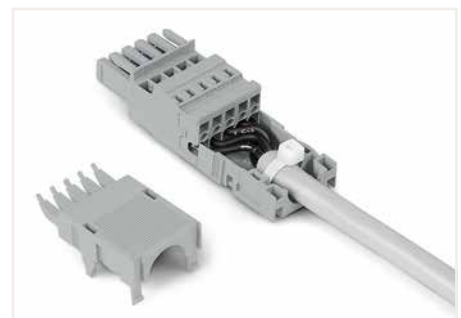

2- to 5-pole strain relief housings feature one cable outlet (rear side).
6- to 7-pole strain relief housings feature one cable outlet
8- to 9-pole strain relief housings feature two cable outlets and one cover.
10- to 16-pole strain relief housings feature three cable outlets and two covers.

Strain relief housing; consists of strain relief support and housing with 1 cable outlet (rear side), 2- to 5-pole only suitable for cable ties (not offered by WAGO); gray

Polzahl	Bestellnr.	VPE
○ 2	769-1602	100
○ 3	769-1603	100
○ 4	769-1604	100
○ 5	769-1605	50

Strain relief housing; consists of strain relief support and housing with 1 cable outlet; gray

Polzahl	Bestellnr.	VPE
○ 6	769-1606	100
○ 7	769-1607	100

Strain relief housing; consists of strain relief support and housing with 2 cable outlets, 1 cover; gray

○ 8	769-1608	50
○ 9	769-1609	50

Strain relief housing; consists of strain relief support and housing with 3 cable outlets, 2 covers; gray

○ 10	769-1610	50
○ 11	769-1611	25
○ 12	769-1612	25
○ 13	769-1613	25
○ 14	769-1614	25
○ 15	769-1615	25

Accessories; item-specific

WSB Quick Marking System; white; 10 strips with 10 markers/card; for 5 ... 17.5 mm terminal block width

	plain	209-501	5
--	-------	---------	---

Accessories; item-specific

Cable clamp; for strain relief

	6 or more poles	209-174	25
--	-----------------	---------	----

Mounting screw; for cable clamp

	6 or more poles	209-173	50
--	-----------------	---------	----

1-Conductor/1-Pin and 2-Pin Carrier Terminal Blocks and 1-Conductor Female Plugs X-COM®-SYSTEM Current-Carrying Capacity Curves

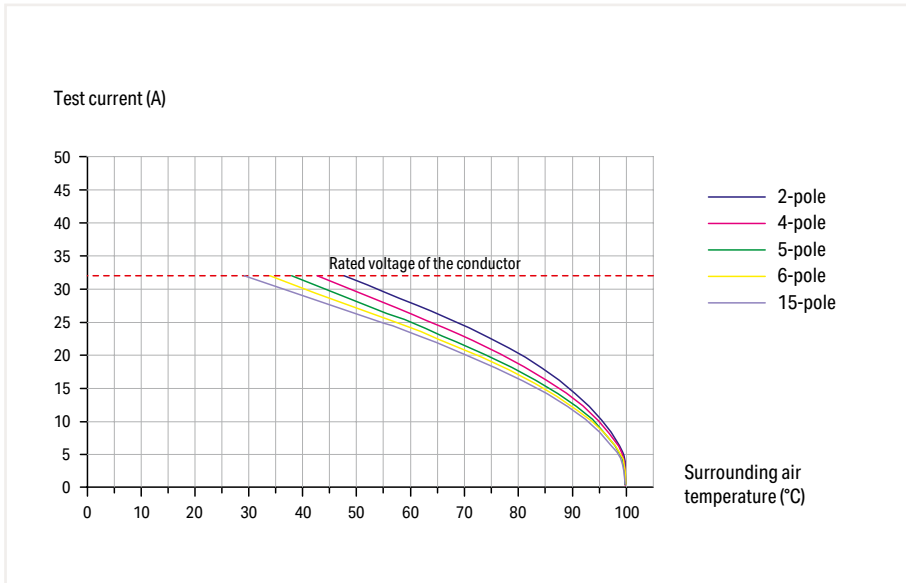

1-conductor/1-pin carrier terminal block (769-176)
Conductor cross section: 4 mm² (12 AWG)

1-conductor female plugs (769-102 to 769-115)
Conductor cross section: 4 mm² (12 AWG)
Conductor loop length: 1 m

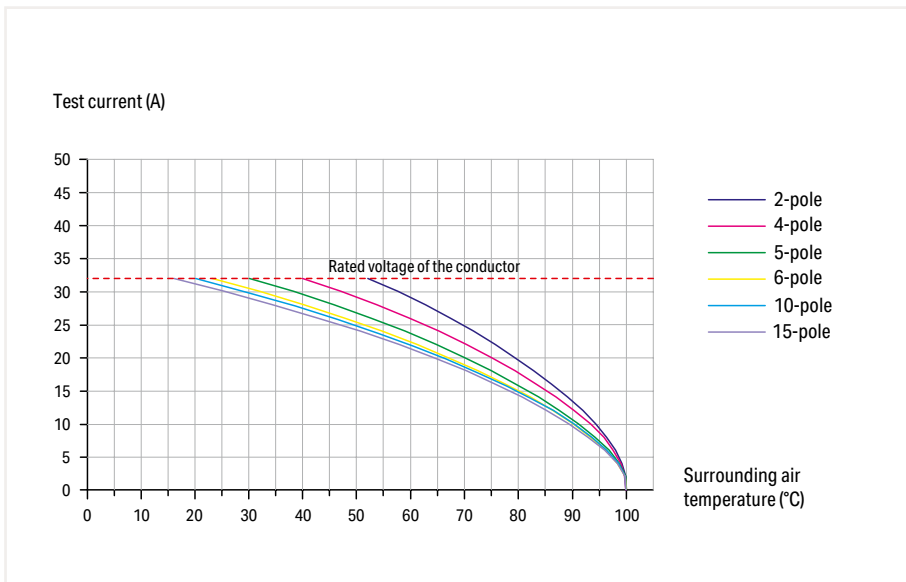

2-pin carrier terminal block (769-156)

1-conductor female plugs (769-102 to 769-115)
Conductor cross section: 4 mm² (12 AWG)
Conductor loop length: 1 m

2-Conductor/2-Pin and 4-Pin Carrier Terminal Blocks and 1-Conductor Female Plugs X-COM®-SYSTEM Current-Carrying Capacity Curves

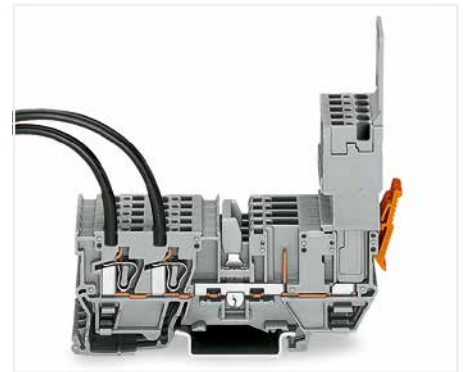
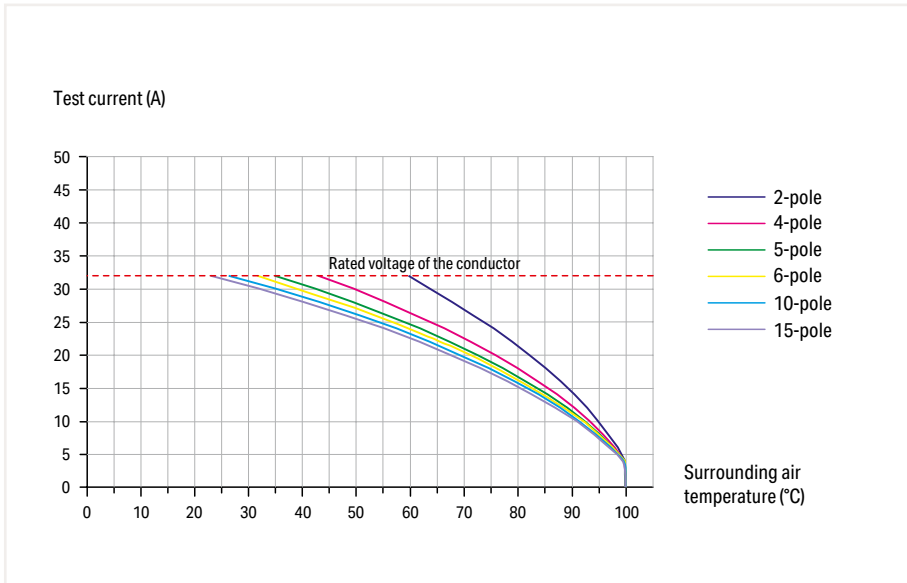

2-conductor/2-pin carrier terminal block (769-171)
Conductor cross section: 4 mm² (12 AWG)

1-conductor female plugs (769-102 to 769-115)
Conductor cross section: 4 mm² (12 AWG)
Conductor loop length: 1 m

7

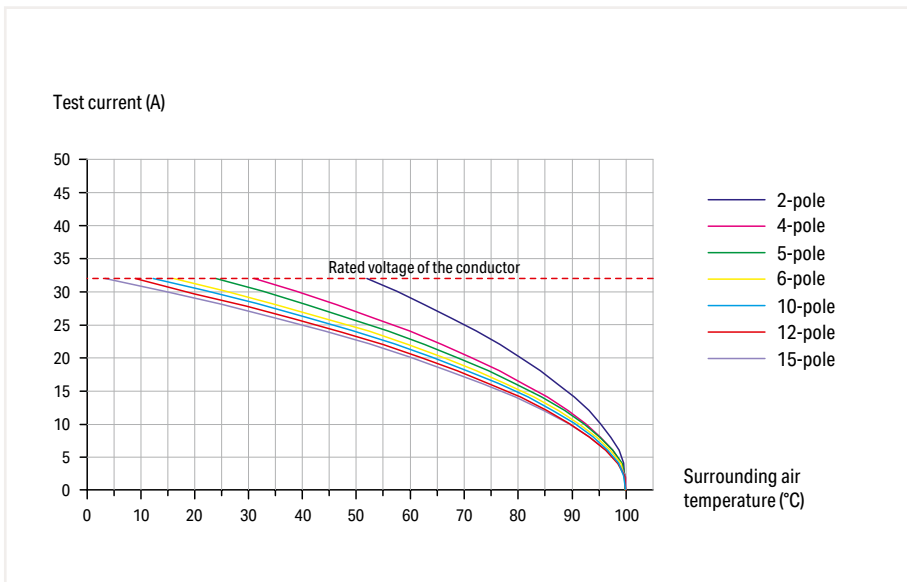

4-pin carrier terminal block (769-151)

1-conductor female plugs (769-102 to 769-115)
Conductor cross section: 4 mm² (12 AWG)
Conductor loop length: 1 m

Male Connectors; with CAGE CLAMP® Connection and 1-Conductor Female Plugs X-COM®-SYSTEM

Current-Carrying Capacity Curves

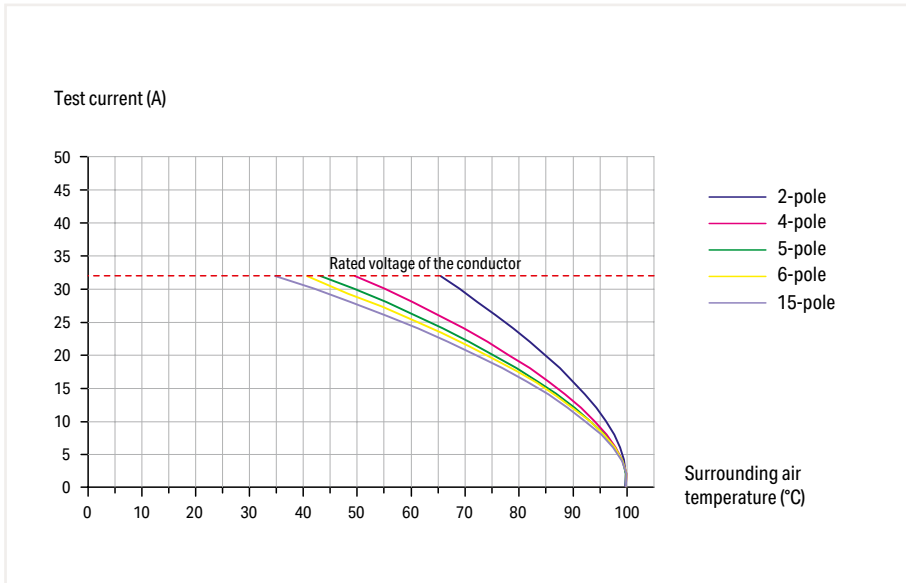

Male connectors with CAGE CLAMP® connection (769-602 to 769-615)
Conductor cross section: 4 mm² (12 AWG)

1-conductor female plugs (769-102 to 769-115)
Conductor cross section: 4 mm² (12 AWG)
Conductor loop length: 1 m

Male Headers with Straight/Angled Solder Pins and 1-Conductor Female Plugs

X-COM®-SYSTEM

Current-Carrying Capacity Curves

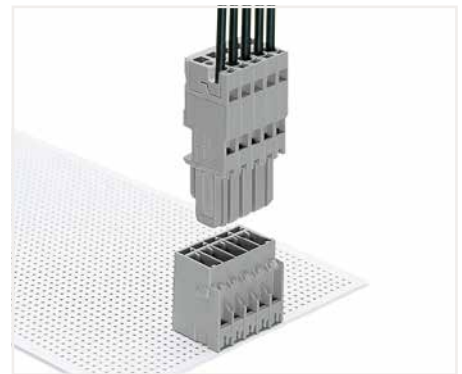
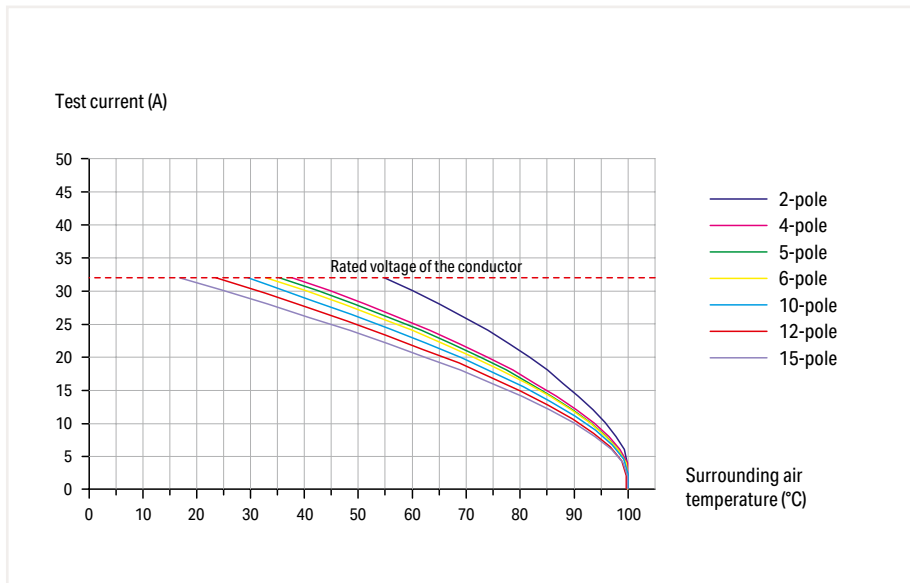

Male headers with straight solder pins (769-632 to 769-645)

1-conductor female plugs (769-102 to 769-115)
 Conductor cross section: 4 mm² (12 AWG)
 Conductor loop length: 1 m

7

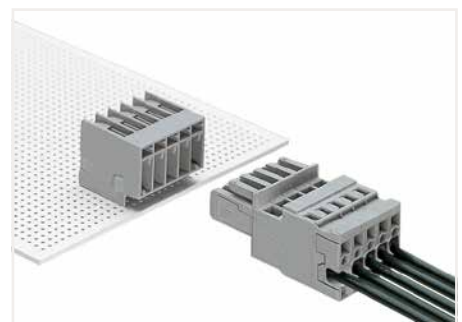
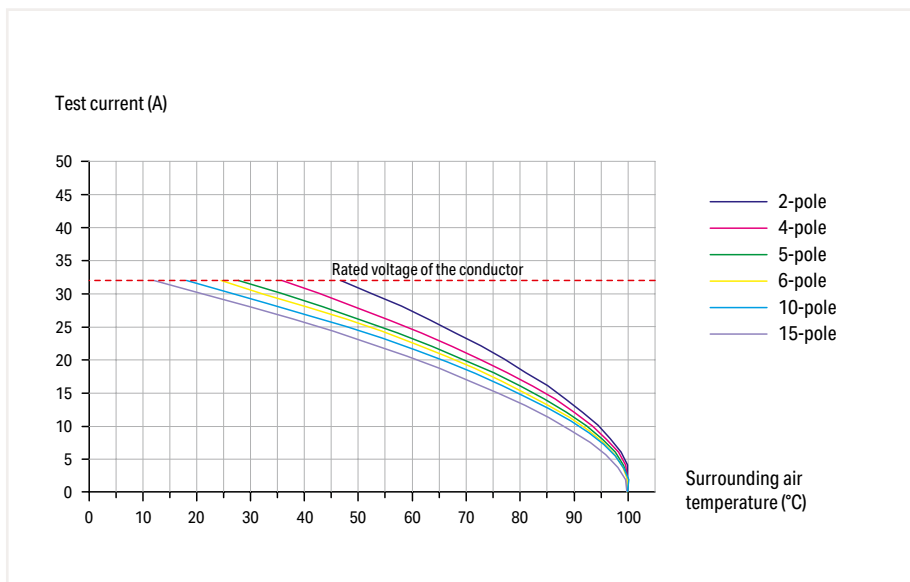

Male headers with angled solder pins (769-662 to 769-675)

1-conductor female plugs (769-102 to 769-115)
 Conductor cross section: 4 mm² (12 AWG)
 Conductor loop length: 1 m

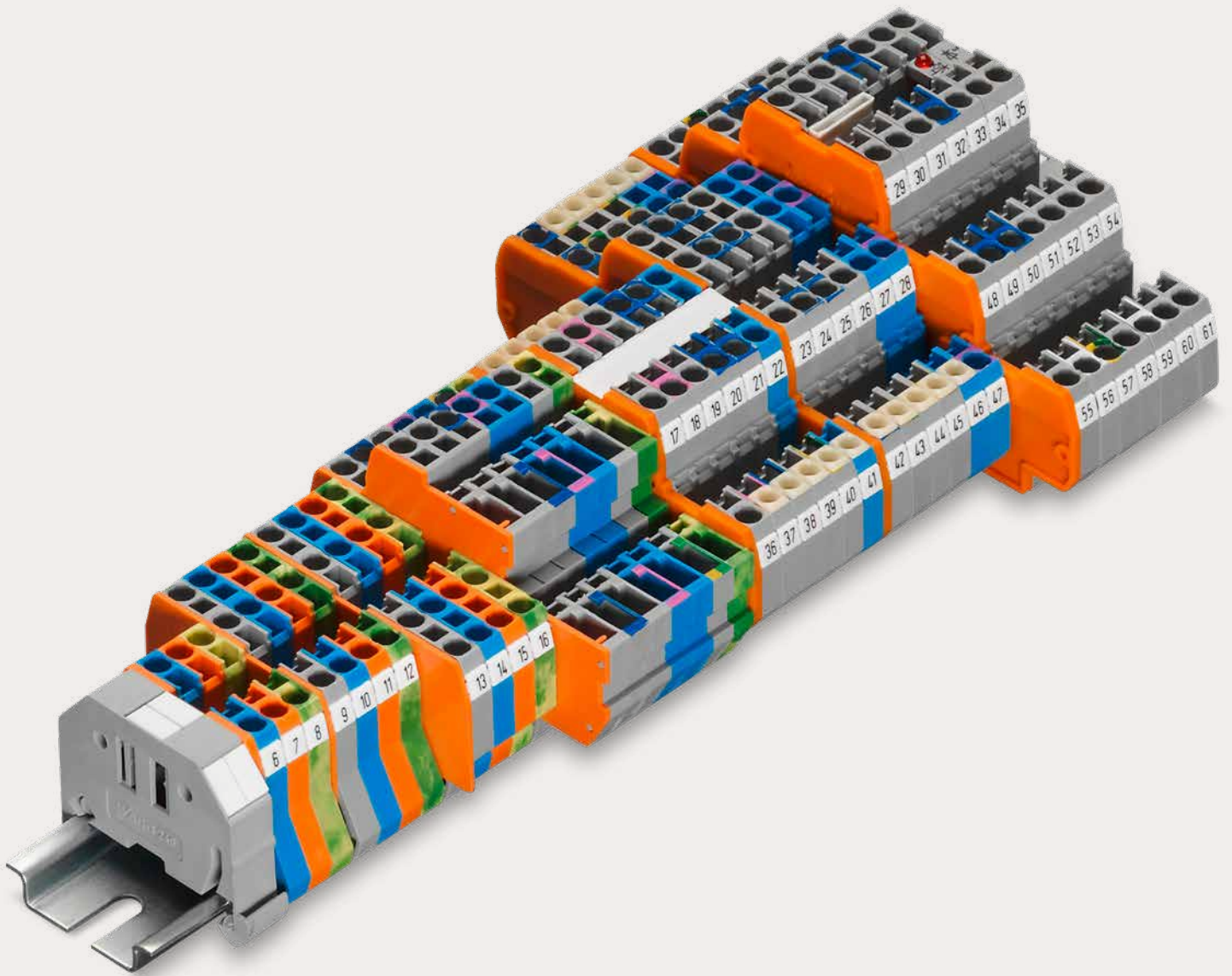







WAGO Rail-Mount Terminal Blocks Mini
WAGO Rail-Mount Terminal Blocks Compact

WAGO Rail-Mount Terminal Blocks Mini

WAGO Rail-Mount Terminal Blocks Compact

Front-Entry Wiring

			Page
	Through, Ground Conductor and Ex Terminal Blocks for DIN-35 and DIN-15 Rails 0.08 ... 2.5 mm ² (28 ... 12 AWG)	264 Series	462
	Through, Ground Conductor and Ex Terminal Blocks for DIN-35 and DIN-15 Rails 0.08 ... 2.5 (4 "f-st") mm ² (28 ... 12 AWG)	870 Series	466
	Multilevel Rail-Mount Terminal Blocks 0.08 ... 2.5 (4 "f-st") mm ² (28 ... 12 AWG)	870 Series	468
	Multilevel Diode and LED Terminal Blocks 0.08 ... 2.5 (4 "f-st") mm ² (28 ... 12 AWG)	870 Series	472
	Sensor and Actuator Terminal Blocks 0.08 ... 2.5 mm ² (28 ... 12 AWG)	270 Series	479
	Accessories for Rail-Mount Terminal Blocks		476

Rail-Mount Terminal Blocks Mini; for DIN-15 and DIN-35 Rails

264 Series

Description and Installation

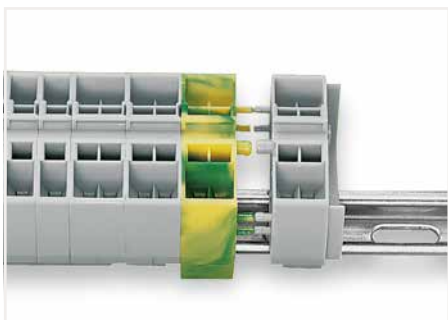

Quick assembly keys prevent reverse mounting.

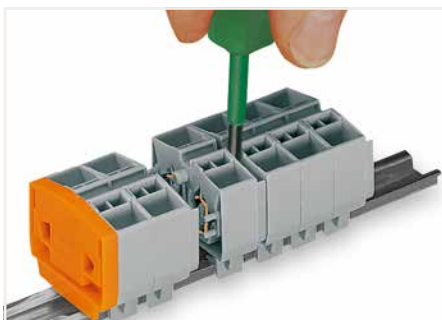

Separate terminal strip and slide individual terminal block laterally.



Remove terminal block from the DIN-rail with a levering action.



Commoning with comb-style jumper bar.

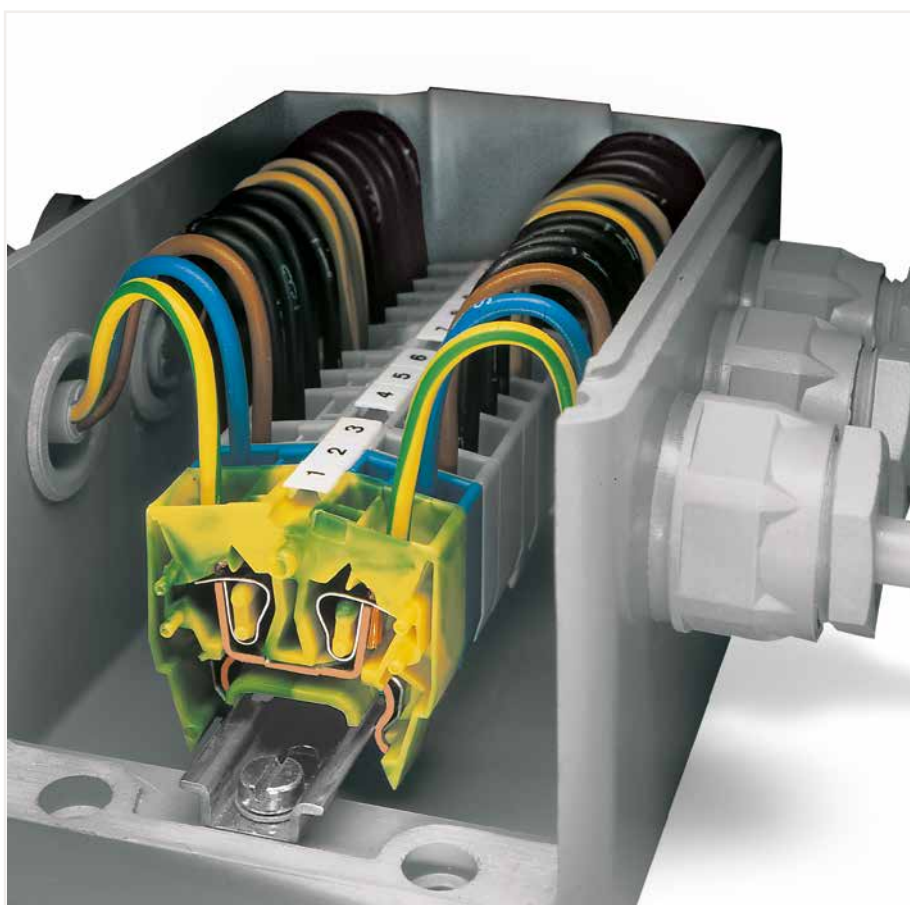

8



Commoning with comb-style jumper bar.

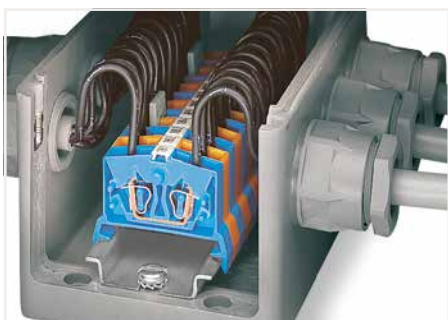

Easy-to-use miniature blocks that require minimal enclosure space.



Combining 2- and 4-conductor terminal blocks.



Marking via Mini-WSB Quick Marking System.



CAGE CLAMP® terminates the following copper conductors: solid "s"



stranded "st"



fine-stranded "f-st", also with tinned single strands



CAGE CLAMP® termination:
Inserting a conductor.
With ferruled conductors, it is necessary to use a terminal block one size smaller than the conductor's nominal cross section.

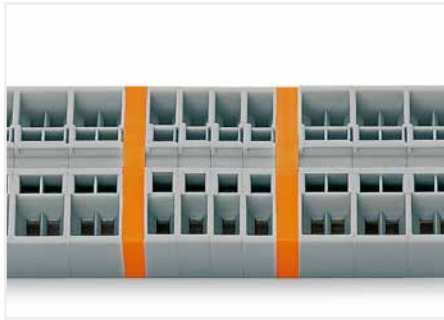

Separating groups via intermediate plates.

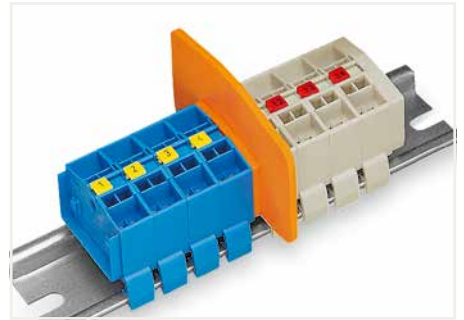

Ex e/Ex i separator plate for miniature rail-mount terminal blocks

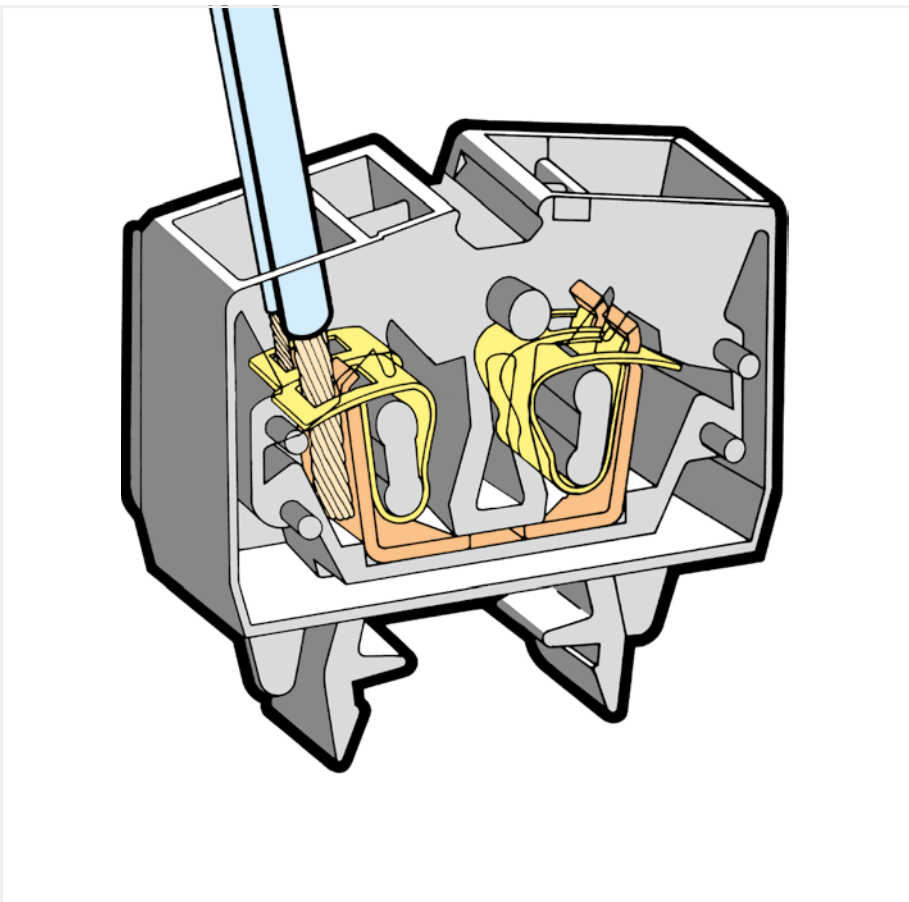

Testing by touch contact to the CAGE CLAMP® spring (limited to 0.5 A and 48 V test voltage) – test pins are not protected against accidental contact.



Testing via CAGE CLAMP® on the current bar (max. nominal current: 6 A) – CAGE CLAMP® clamps individual test contacts. The maximum test voltage is 400 V.



Marking with T-marker tag (209-290).



fine-stranded, tip-bonded



fine-stranded, with ferrule (gastight crimped)



fine-stranded, with pin terminal (gastight crimped)

Miniature Through/Ground Conductor and Ex Terminal Block; for DIN-35 Rail

2.5 mm²; 264 Series

Technical Data	
0.08 ... 2.5 mm ²	28 ... 12 AWG*
800 V/8 kV/3 ❶	300 V, 20 A ❷
I _N 24 A	600 V, 20 A ❸
Terminal block width: 6 mm / 0.236 inch	
8 ... 9 mm / 0.31 ... 0.35 inch	



2-conductor miniature through terminal block; for DIN-35 rail		
Color	Item No.	Pack. Unit
gray	264-711	100
blue	264-714 ❷	100
orange	264-716	100
light gray ❸	264-125 ❸	100

Accessories; item-specific
Alternate comb-style jumper bar; insulated; I_N = I_N of terminal block

2-way	281-492	100 (25)
-------	---------	----------

Test plug module; snaps together; 6 mm wide		
	Item No.	Pack. Unit
gray	249-136	100 (25)

Technical Data	
0.08 ... 2.5 mm ²	28 ... 12 AWG*
800 V/8 kV/3 ❶	300 V, 20 A ❷
I _N 24 A	600 V, 20 A ❸
Terminal block width: 10 mm / 0.394 inch	
8 ... 9 mm / 0.31 ... 0.35 inch	

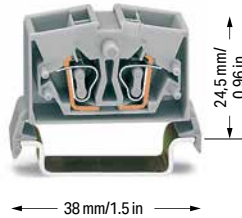

4-conductor miniature through terminal block; for DIN-35 rail		
Color	Item No.	Pack. Unit
gray	264-731	100
blue	264-734 ❷	100
orange	264-736	100
light gray ❸	264-225 ❸	100

Accessories; item-specific
Alternate comb-style jumper bar; insulated; I_N = I_N of terminal block

2-way	280-492	200 (25)
-------	---------	----------

Test plug module; snaps together; 10 mm wide		
	Item No.	Pack. Unit
gray	249-139	100 (25)

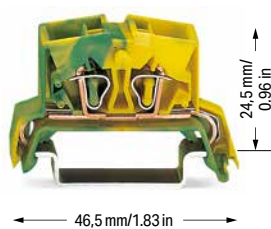

4-conductor miniature ground terminal block; for DIN-35 rail		
Color	Item No.	Pack. Unit
green-yellow	264-737	100
green-yellow ❸	264-737/999-950 ❸	100

Accessories; item-specific
Alternate comb-style jumper bar; insulated; I_N = I_N of terminal block

2-way	280-492	200 (25)
-------	---------	----------

Test plug module; snaps together; 10 mm wide		
	Item No.	Pack. Unit
gray	249-139	100 (25)

*12 AWG: THHN, THWN

- ❶ 800 V = rated voltage
8 kV = rated impulse voltage
3 = pollution degree (see Section 15)
- ❷ Terminal blocks with a blue insulated housing are suitable for Ex i applications.
- ❸ Terminal blocks with an Ex mark are suitable for Ex e II applications.
0.5 ... 2.5 mm² / 20 ... 12 AWG*
690 V; 23 A (see Section 15)

See application notes for:
Alternate comb-style jumper bar, page 383
Test plug module, page 510
Mini-WSB marking system, page 641

Approvals and corresponding ratings, visit www.wago.com

Accessories; 264 Series

Appropriate marking systems:
Mini-WSB/Mini-WSB Inline/T-marker tag

End and intermediate plate; 4 mm thick		
Color	Item No.	Pack. Unit
orange	264-369	25
gray	264-368	25
light gray	264-370	25

Ex e/Ex i separator; orange; 4 mm thick		
Width	Item No.	Pack. Unit
66 mm	264-367	25

Comb-style jumper bar; insulated; reduces maximum conductor size to 1.5 mm ² ; I _N 16 A; gray		
Way	Item No.	Pack. Unit
2-way	264-402	200 (25)

Operating tool; insulated		
Way	Item No.	Pack. Unit
2-way	280-432	1

Test plug; with 500 mm cable; 2 mm Ø; max. 42 V		
Color	Item No.	Pack. Unit
red	210-136	50

Mini-WSB Inline, plain; 1,700 WMB markers (5 mm)/reel; 5 ... 5.2 mm stretchable		
Color	Item No.	Pack. Unit
white	2009-145	1

Mini-WSB marking card; white; 10 strips with 10 markers/card; 5 mm wide markers		
Color	Item No.	Pack. Unit
plain	248-501	5

Screwless end stop; for DIN-35 rail; 6 mm wide		
Color	Item No.	Pack. Unit
gray	249-116	100 (25)

Steel DIN-rail; per EN 60715; 35 x 7.5 mm; 1 mm thick; 2 m long		
Type	Item No.	Pack. Unit
slotted	210-112	10 (1)
unslotted	210-113	10

Aluminum DIN-rail; similar to EN 60715; 35 x 8.2 mm; 1.6 mm thick; 2 m long		
Type	Item No.	Pack. Unit
unslotted	210-196	10

Miniature Through/Ground Conductor and Ex Terminal Block; for DIN-15 Rail

2.5 mm²; 264 Series

Technical Data	
0.08 ... 2.5 mm ²	28 ... 12 AWG*
800 V/8 kV/3 ①	300 V, 20 A ②
I _N 24 A	600 V, 20 A ③
Terminal block width: 6 mm / 0.236 inch	
8 ... 9 mm / 0.31 ... 0.35 inch	

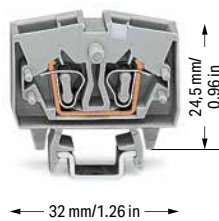

2-conductor miniature through terminal block; for DIN-15 rail		
Color	Item No.	Pack. Unit
gray	264-701	100
blue	264-704 ②	100
orange	264-706	100
light gray ③	264-120 ③	100

Accessories; item-specific		
Alternate comb-style jumper bar; insulated; I _N = I _N of terminal block		

2-way	281-492	100 (25)
-------	---------	----------

Test plug module; snaps together; 6 mm wide		
gray	249-136	100 (25)

Technical Data	
0.08 ... 2.5 mm ²	28 ... 12 AWG*
800 V/8 kV/3 ①	300 V, 20 A ②
I _N 24 A	600 V, 20 A ③
Terminal block width: 10 mm / 0.394 inch	
8 ... 9 mm / 0.31 ... 0.35 inch	

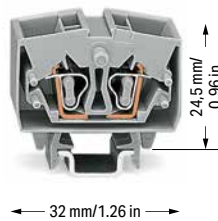

4-conductor miniature through terminal block; for DIN-15 rail		
Color	Item No.	Pack. Unit
gray	264-721	100
blue	264-724 ②	100
orange	264-726	100
light gray ③	264-220 ③	100

Accessories; item-specific		
Alternate comb-style jumper bar; insulated; I _N = I _N of terminal block		

2-way	280-492	200 (25)
-------	---------	----------

Test plug module; snaps together; 10 mm wide		
gray	249-139	100 (25)



4-conductor miniature ground terminal block; for DIN-15 rail		
Color	Item No.	Pack. Unit
green-yellow	264-727	100
green-yellow ③	264-727/999-950 ③	100

Accessories; item-specific		
Alternate comb-style jumper bar; insulated; I _N = I _N of terminal block		

2-way	280-492	200 (25)
-------	---------	----------

Test plug module; snaps together; 10 mm wide		
gray	249-139	100 (25)

*12 AWG: THHN, THWN

- ① 800 V = rated voltage
8 kV = rated impulse voltage
3 = pollution degree
(see Section 15)
- ② Terminal blocks with a blue insulated housing are suitable for Ex i applications.
- ③ Terminal blocks with an Ex mark are suitable for Ex e II applications.
0.5 ... 2.5 mm² / 20 ... 12 AWG*
690 V; 23 A
(see Section 15)

See application notes for:
Alternate comb-style jumper bar, page 383
Test plug module, page 510
Mini-WSB marking system, page 641

Approvals and corresponding ratings, visit www.wago.com

Accessories; 264 Series

Appropriate marking systems:
Mini-WSB/Mini-WSB Inline/T-marker tag

End and intermediate plate; 4 mm thick		
orange	264-369	25
gray	264-368	25
light gray	264-370	25

Ex e/Ex i separator; orange; 4 mm thick		
66 mm	264-367	25

Comb-style jumper bar; insulated; reduces maximum conductor size to 1.5 mm ² ; I _N 16 A; gray		
2-way	264-402	200 (25)

Operating tool; insulated		
2-way	280-432	1

Test plug; with 500 mm cable; 2 mm Ø; max. 42 V		
red	210-136	50

Mini-WSB Inline, plain; 1,700 WMB markers (5 mm)/reel; 5 ... 5.2 mm stretchable		
white	2009-145	1

Mini-WSB marking card; white; 10 strips with 10 markers/card; 5 mm wide markers		
plain	248-501	5

Screwless end stop; for DIN-15 rail; 6 mm wide		
gray	249-101	25

Steel DIN-rail; per EN 60715; 15 x 5.5 mm; 1 mm thick; 2 m long		
slotted	210-111	10 (1)
unslotted	210-295	10 (1)

Aluminum DIN-rail; similar to EN 60715; 15 x 5.5 mm; 1 mm thick; 2 m long		
unslotted	210-296	1

Rail-Mount Terminal Blocks Compact; for DIN-15 and DIN-35 Rails

870 Series

Description and Installation

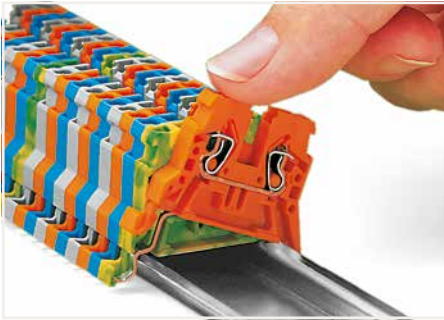

Snapping a rail-mount terminal block onto DIN-35 rail.

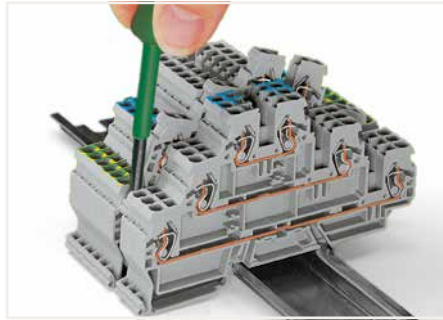

Removing a terminal block from the assembly.



Inserting insulation stops into conductor entry holes of terminal strip.



Push jumper bars down firmly until fully inserted. When using multipole bars, push alternately on the right and then left side until installed. Push-in type jumper bars 1-3-5-7 or 1-4-7 are available upon request.

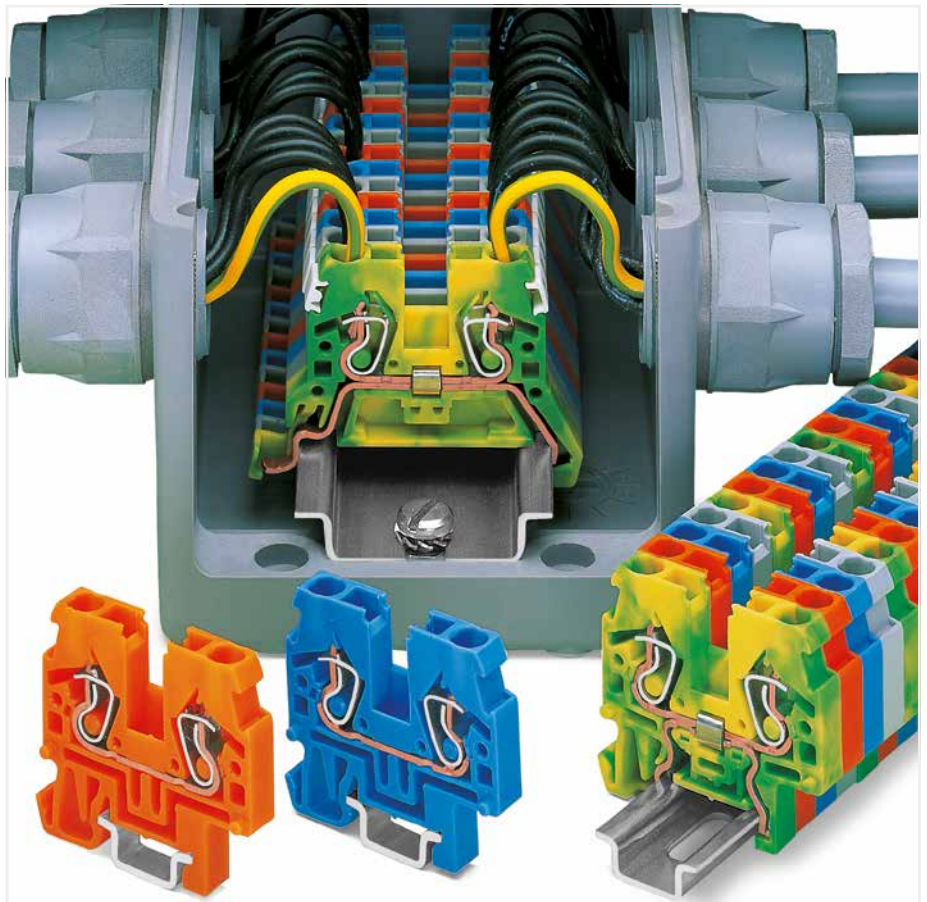

8



Commoning with push-in type jumper bars: Two parallel jumper slots are accommodated in one terminal block.



Commoning terminal blocks of different sizes via step-down jumpers.

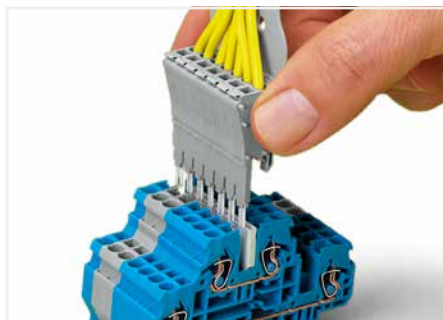

Testing: Using a pre-wired module assembly, similar to test plugs.

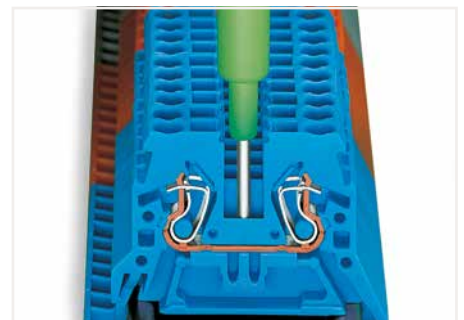

Testing with phase testing device, also possible with single-pole voltage tester.



CAGE CLAMP® terminates the following copper conductors: solid "s"



stranded "st"



fine-stranded "f-st", also with tinned single strands



CAGE CLAMP® termination:
Inserting a conductor via operating tool (0.08 ... 4 mm² "f-st").
With ferruled conductors, it is necessary to use a terminal block one size smaller than the conductor's nominal cross section.

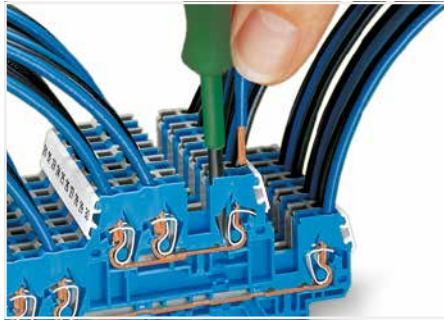

CAGE CLAMP® termination:
Inserting a conductor via operating tool (0.08 ... 4 mm² "f-st").

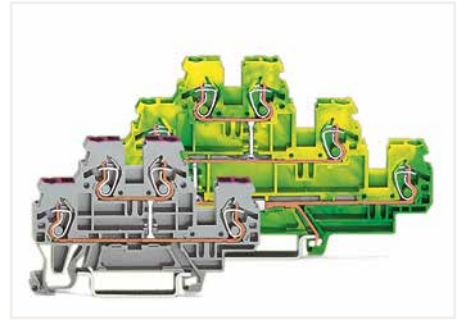

Multilevel terminal blocks:
Double- and triple-deck terminal blocks with internal comings acting as 4- and 6-conductor terminal blocks

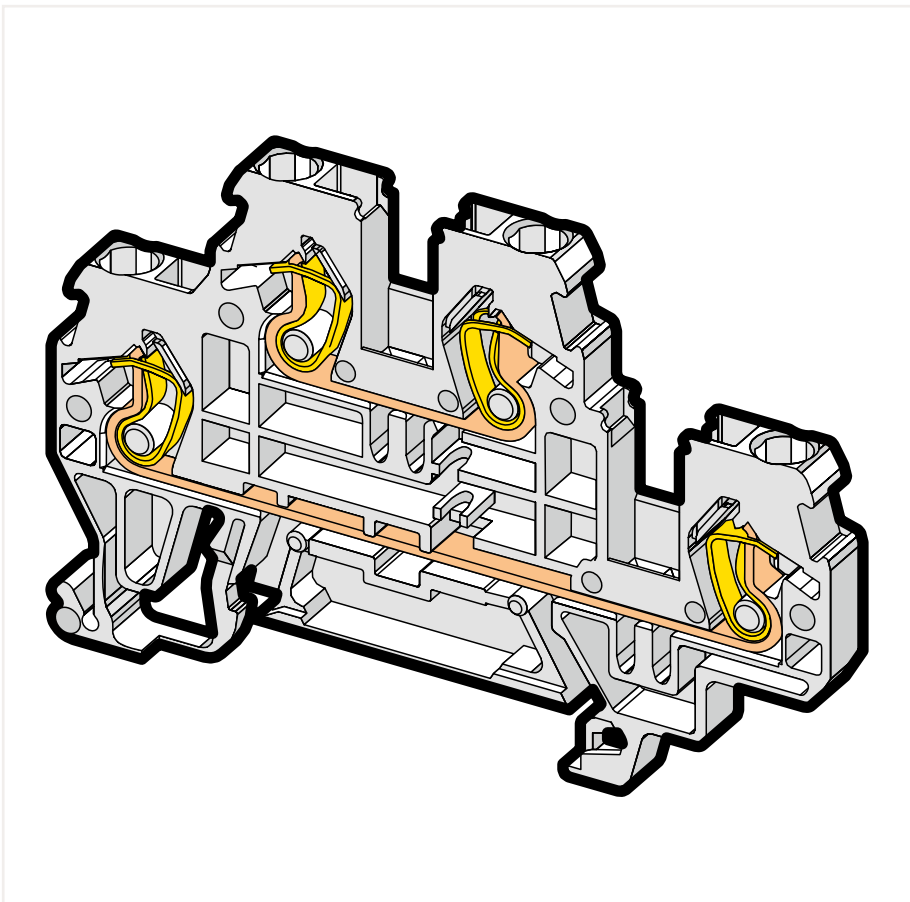

Protective warning marker (280-405); with a black high-voltage symbol

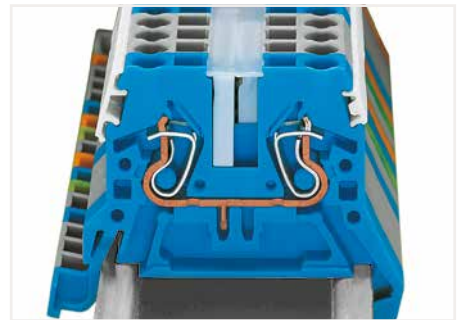

WMB markers in Mini-WSB marker slots
Marking strip; translucent
Mini-WSB markers



Use 50% less rail space with double-deck terminal blocks.

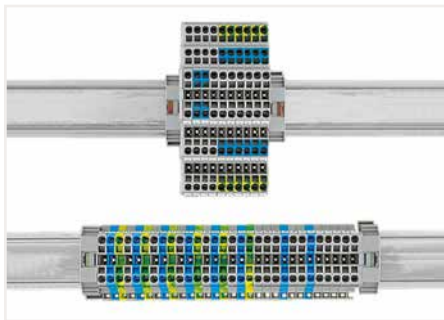

Use 67% less rail space with triple-deck terminal blocks.



Translucent marking strip (709-196) – jumpers below may be visible.



fine-stranded, tip-bonded



fine-stranded, with ferrule (gastight crimped)



fine-stranded, with pin terminal (gastight crimped)

Through/Ground Conductor/Ex and Double-Potential Terminal Block for DIN-35 and DIN-15 Rails

2.5 (4 "f-st") mm²; 870 Series

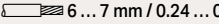
Technical Data	
0.08 ... 2.5 (4 "f-st") mm ² ①	28 ... 12 AWG
500 V/6 kV/3 ②	300 V, 20 A, $\overline{V_{UL}}$
I_N 24 A	
Terminal block width: 5 mm / 0.197 inch	
 6 ... 7 mm / 0.24 ... 0.28 inch	

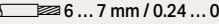
Technical Data	
0.08 ... 2.5 (4 "f-st") mm ² ①	28 ... 12 AWG
500 V/6 kV/3 ②	300 V, 20 A, $\overline{V_{UL}}$
I_N 24 A	
Terminal block width: 5 mm / 0.197 inch	
 6 ... 7 mm / 0.24 ... 0.28 inch	

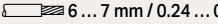
Technical Data	
0.08 ... 2.5 (4 "f-st") mm ² ①	28 ... 12 AWG
500 V/6 kV/3 ②	300 V, 20 A, $\overline{V_{UL}}$
I_N 24 A	
Terminal block width: 5 mm / 0.197 inch	
 6 ... 7 mm / 0.24 ... 0.28 inch	

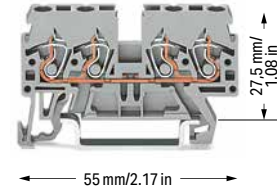
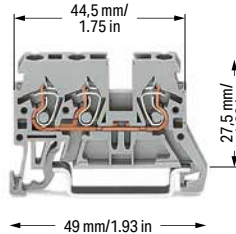
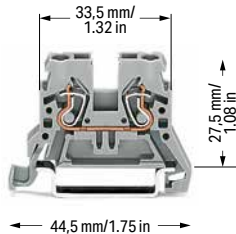

2-conductor through terminal block; for DIN-35 rail		
Color	Item No.	Pack. Unit
gray	870-901	100
blue	870-904 ③	100
orange	870-902	100
light gray ④	870-909 ④	100

3-conductor through terminal block; for DIN-35 rail		
Color	Item No.	Pack. Unit
gray	870-681	100
blue	870-684 ③	100
orange	870-682	100



4-conductor through terminal block; for DIN-35 rail		
Color	Item No.	Pack. Unit
gray	870-831	100
blue	870-834 ③	100
orange	870-832	100



2-conductor ground terminal block; for DIN-35 rail		
Notice: This ground conductor terminal block cannot be commoned with push-in type jumper bars!		
green-yellow	870-907	100
green-yellow ④	870-907/999-950 ④	100



3-conductor ground terminal block; for DIN-35 rail		
Notice: This ground conductor terminal block cannot be commoned with push-in type jumper bars!		
green-yellow	870-687	100



4-conductor ground terminal block; for DIN-35 rail		
Notice: This ground conductor terminal block cannot be commoned with push-in type jumper bars!		
green-yellow	870-837	100



Other terminal blocks with the same profile:		
Double-potential	870-826	Page 467



Accessories; item-specific			
End and intermediate plate; 2 mm thick			
	orange	870-924	100 (25)
	gray	870-923	100 (25)
	light gray	870-925	100 (25)

Accessories; item-specific			
End and intermediate plate; 1 mm thick			
	orange	870-934	100 (25)
	gray	870-933	100 (25)

Accessories; item-specific			
End and intermediate plate; 1 mm thick			
	orange	870-944	100 (25)
	gray	870-943	100 (25)

Separator; oversized; 2 mm thick			
	orange	870-929	100 (25)
	gray	870-928	100 (25)

Separator; oversized; 1 mm thick			
	orange	870-947	100 (25)
	gray	870-946	100 (25)

Separator; oversized; 1 mm thick			
	orange	870-949	100 (25)
	gray	870-948	100 (25)

End and intermediate plate; 2 mm thick; for 2-conductor ground conductor Ex terminal blocks only			
	green-yellow	870-926	100 (25)

Ex e/Ex i separator; orange; 3 mm thick			
	90 mm	209-190	50 (25)
	120 mm	209-191	50 (25)

Accessories; 870 Series

Appropriate marking systems: Mini-WSB/Mini-WSB Inline/WMB/WMB Inline

Insulation stop; 0.08 ... 0.2 mm ² "s" (0.14 mm ² "f-st"); 5 pcs/strip			
	white	280-470	200 (25)

Push-in type jumper bar; insulated; I_N 18 A; light gray			
	2-way	870-402	200 (25)
	3-way	870-403	200 (25)
	4-way	870-404	100 (25)
	5-way	870-405	100 (25)
	6-way	870-406	100 (25)
	7-way	870-407	100 (25)
	8-way	870-408	100 (25)
	9-way	870-409	100 (25)
	10-way	870-410	50 (25)

Push-in type jumper bar; insulated; I_N 18 A; light gray			
	1 to 3	870-433	200 (25)
	1 to 4	870-434	200 (25)
	1 to 5	870-435	100 (25)
	1 to 6	870-436	100 (25)
	1 to 7	870-437	100 (25)
	1 to 8	870-438	100 (25)
	1 to 9	870-439	100 (25)
	1 to 10	870-440	50 (25)

Insulation stop; 0.25 ... 0.5 mm ² ; 5 pcs/strip			
	light gray	280-471	200 (25)

Insulation stop; 0.75 ... 1 mm ² ; 5 pcs/strip			
	dark gray	280-472	200 (25)

Technical Data	
0.08 ... 2.5 (4 "f-st") mm ² ①	28 ... 12 AWG
500 V/6 kV/3 ②	300 V, 20 A, ③
I _N 24 A	
Terminal block width: 5 mm / 0.197 inch	
6 ... 7 mm / 0.24 ... 0.28 inch	

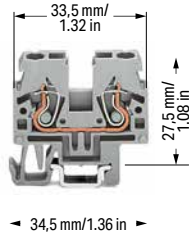

2-conductor through terminal block; for DIN-15 rail		
Color	Item No.	Pack. Unit
gray	870-911	100
light gray	870-914 ③	100
orange	870-912	100
light gray ④	870-919 ④	100

2-conductor ground terminal block; for DIN-15 rail		
Notice: This ground conductor terminal block cannot be commoned with push-in type jumper bars!		
Color	Item No.	Pack. Unit
green-yellow	870-917	100
green-yellow ④	870-917/999-950 ④	100

Accessories; item-specific			
End and intermediate plate; 2 mm thick			
	orange	870-924	100 (25)
	gray	870-923	100 (25)
	light gray	870-925	100 (25)

Separator; oversized; 2 mm thick			
	orange	870-929	100 (25)
	gray	870-928	100 (25)

End and intermediate plate; 2 mm thick; for 2-conductor ground conductor Ex terminal blocks only			
	green-yellow	870-926	100 (25)

Ex e/Ex i separator; orange; 3 mm thick			
	90 mm	209-190	50 (25)
	120 mm	209-191	50 (25)

Protective warning marker; with black high-voltage symbol; for 5 terminal blocks			
	yellow	280-405	100 (25)

Tap-off module; with anti-reverse mating protection; snaps together; 5 mm wide			
	gray	870-425	100 (25)

Technical Data	
0.08 ... 2.5 (4 "f-st") mm ² ①	28 ... 12 AWG
500 V/6 kV/3 ②	300 V, 20 A, ③
I _N 24 A	
Terminal block width: 5 mm / 0.197 inch	
6 ... 7 mm / 0.24 ... 0.28 inch	

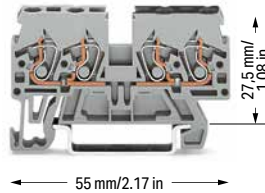

Double-potential terminal block; with integrated marking level		
Color	Item No.	Pack. Unit
gray	870-826	100

Notice: These double-potential terminal blocks cannot be commoned with push-in type jumper bars! Front-entry double-potential terminal blocks are space savers. Two independent feedthrough circuits are placed in one insulated housing on one level in just 5 mm. This achieves a width of just 2.5 mm versus standard through terminal blocks for a total height of just 27.5 mm from the upper-edge of DIN-rail. Input and output of a circuit are placed on the same side of the terminal block. Both circuits can be individually marked according to input and output. Technical data and accessories, visit www.wago.com

Accessories; item-specific			
End and intermediate plate; 1 mm thick			
	orange	870-944	100 (25)
	gray	870-943	100 (25)

Separator; oversized; 1 mm thick			
	orange	870-949	100 (25)
	gray	870-948	100 (25)

Mini-WSB Inline, plain; 1,700 WMB markers (5 mm)/reel; 5 ... 5.2 mm stretchable			
	white	2009-145	1

Mini-WSB marking card; white; 10 strips with 10 markers/card; 5 mm wide markers			
	plain	248-501	5

- Max. insulation diameter: 4.4 mm
 - 500 V = rated voltage
6 kV = rated impulse voltage
3 = pollution degree (see Section 15)
 - Terminal blocks with a blue insulated housing are suitable for Ex i applications.
 - Suitable for Ex e II applications
0.2 ... 2.5 (4 "f-st") mm² / 24 ... 12 AWG
440 V; 22 A (see Section 15)
Using one or more push-in type jumper bars, the maximum rated voltage is reduced to 275 V and the rated current to 13.5 A.
- See application notes for:
Insulation stop, page 382
Tap-off module, page 477
Group marker carrier, page 471
- Approvals and corresponding ratings, visit www.wago.com



Mounting on DIN-15 rail:
Snap individual terminal blocks onto the DIN-15 rail and slide together.

Removal from DIN-15 rail:
Open assembly by laterally sliding terminal blocks with an operating tool and remove them from the rail.



In order to meet creepage and clearance requirements for Ex e applications, it is necessary to insert an end or intermediate plate between a through and a ground conductor terminal block. End plates 870-923 (gray), 870-924 (orange) and 870-925 (light gray), as well as separator plates 870-928 (gray) and 870-929 (orange) cannot be assembled to 2-conductor ground Ex terminal blocks (870-907/999-950).

Double-Deck Terminal Block

2.5 (4 "f-st") mm²; 870 Series

Technical Data

0.08 ... 2.5 (4 "f-st") mm² ① | 28 ... 12 AWG
 500 V/6 kV/3 ② | 300 V, 20 A, I_N
 I_N 24 A
 Terminal block width: 5 mm / 0.197 inch
 6 ... 7 mm / 0.24 ... 0.28 inch

Technical Data

0.08 ... 2.5 (4 "f-st") mm² ① | 28 ... 12 AWG
 500 V/6 kV/3 ②
 I_N 24 A
 Terminal block width: 5 mm / 0.197 inch
 6 ... 7 mm / 0.24 ... 0.28 inch

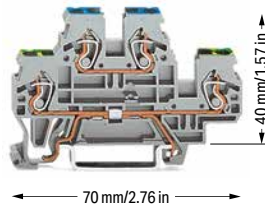
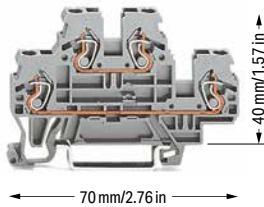

Double-deck terminal block; through/through terminal block; gray

	Item No.	Pack. Unit
○ L/L	870-501	50
○ N/L	870-502	50
○ L/N	870-503	50

Double-deck terminal block; ground conductor/through terminal block; gray

	Item No.	Pack. Unit
○ PE/N	870-517	50
○ PE/L	870-527	50

Double-deck terminal block; through/through terminal block; blue

● N/N	870-504 ③	50
-------	-----------	----

Double-deck terminal block; ground conductor/through terminal block; light gray

○ PE/L ④	870-967/999-950 ③	50
----------	-------------------	----

Double-deck terminal block; through/through terminal block; light gray

○ L/L ⑤	870-961 ④	50
---------	-----------	----

Other terminal blocks with the same profile:

Diode	870-540/281-410	Page 472
LED	870-543/281-434	Page 472

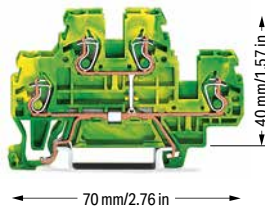
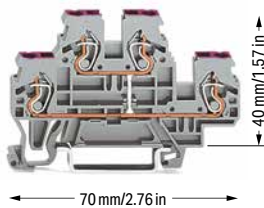

Double-deck terminal block; 4-conductor through terminal block; internally commoned; Violet conductor entry; gray

	Item No.	Pack. Unit
○ L	870-508	50

Double-deck terminal block; 4-conductor ground terminal block; internally commoned; green-yellow



	Item No.	Pack. Unit
● PE	870-507	50

Double-deck terminal block; 4-conductor through terminal block; internally commoned; Violet conductor entry; blue

● N	870-509 ③	50
-----	-----------	----

- Max. insulation diameter: 4.4 mm
 - 500 V = rated voltage
6 kV = rated impulse voltage
3 = pollution degree (see Section 15)
 - Terminal blocks with a blue insulated housing are suitable for Ex i applications.
 - Suitable for Ex e II applications
0.2 ... 2.5 (4 "f-st") mm² / 24 ... 12 AWG
440 V; 22 A (see Section 15)
Using one or more push-in type jumper bars, the maximum rated voltage is reduced to 275 V and the rated current to 13.5 A.
- See application notes for:
Insulation stop, page 382
Group marker carrier, page 471
- Approvals and corresponding ratings, visit www.wago.com

Accessories; 870 Series

- Appropriate marking systems:
Mini-WSB/Mini-WSB Inline/WMB/WMB Inline
- End and intermediate plate; 2 mm thick
- | | | | |
|---|--------|---------|----------|
|  | orange | 870-519 | 100 (25) |
|  | gray | 870-518 | 100 (25) |

- Ex e/Ex i separator; orange; 3 mm thick
- | | | | |
|---|----------|---------|---------|
|  | 125.5 mm | 209-192 | 50 (25) |
|---|----------|---------|---------|

- Insulation stop; 0.08 ... 0.2 mm² "s" (0.14 mm² "f-st"); 5 pcs/strip
- | | | | |
|---|-------|---------|----------|
|  | white | 280-470 | 200 (25) |
|---|-------|---------|----------|

- Insulation stop; 0.25 ... 0.5 mm²; 5 pcs/strip
- | | | | |
|---|------------|---------|----------|
|  | light gray | 280-471 | 200 (25) |
|---|------------|---------|----------|

- Insulation stop; 0.75 ... 1 mm²; 5 pcs/strip
- | | | | |
|---|-----------|---------|----------|
|  | dark gray | 280-472 | 200 (25) |
|---|-----------|---------|----------|

- Protective warning marker; with black high-voltage symbol; for 5 terminal blocks
- | | | | |
|---|--------|---------|----------|
|  | yellow | 280-405 | 100 (25) |
|---|--------|---------|----------|

- Push-in type jumper bar; insulated; I_N 18 A; light gray
- | | | | |
|---|--------|---------|----------|
|  | 2-way | 870-402 | 200 (25) |
| | 3-way | 870-403 | 200 (25) |
| | 4-way | 870-404 | 100 (25) |
| | 5-way | 870-405 | 100 (25) |
| | 6-way | 870-406 | 100 (25) |
| | 7-way | 870-407 | 100 (25) |
| | 8-way | 870-408 | 100 (25) |
| | 9-way | 870-409 | 100 (25) |
| | 10-way | 870-410 | 50 (25) |

- Push-in type jumper bar; insulated; I_N 18 A; light gray
- | | | | |
|---|---------|---------|----------|
|  | 1 to 3 | 870-433 | 200 (25) |
| | 1 to 4 | 870-434 | 200 (25) |
| | 1 to 5 | 870-435 | 100 (25) |
| | 1 to 6 | 870-436 | 100 (25) |
| | 1 to 7 | 870-437 | 100 (25) |
| | 1 to 8 | 870-438 | 100 (25) |
| | 1 to 9 | 870-439 | 100 (25) |
| | 1 to 10 | 870-440 | 50 (25) |

3-Conductor Double-Deck Terminal Block

2.5 (4 "f-st") mm²; 870 Series

Technical Data	
0.08 ... 2.5 (4 "f-st") mm ² ①	28 ... 12 AWG
500 V/6 kV/3 ②	300 V, 20 A, I_N
I_N 24 A	
Terminal block width: 5 mm / 0.197 inch	
6 ... 7 mm / 0.24 ... 0.28 inch	

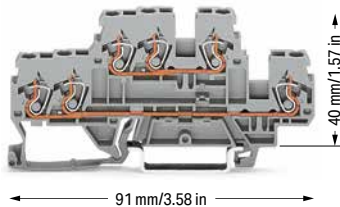

3-conductor double-deck terminal block; through/through terminal block; gray		
	Item No.	Pack. Unit
○ L/L	870-531	50
○ N/L	870-532	50
○ L/N	870-533	50

3-conductor double-deck terminal block; through/through terminal block; blue		
● N/N	870-534 ③	50

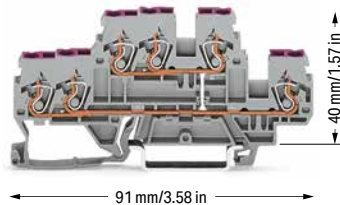

3-conductor double-deck terminal block; 6-conductor through terminal block; internally commoned; Violet conductor entry; gray		
	Item No.	Pack. Unit
○ L	870-538	50

3-conductor double-deck terminal block; 6-conductor through terminal block; internally commoned; Violet conductor entry; blue		
● N	870-539 ③	50

Technical Data	
0.08 ... 2.5 (4 "f-st") mm ² ①	28 ... 12 AWG
500 V/6 kV/3 ②	I_N 24 A
Terminal block width: 5 mm / 0.197 inch	
6 ... 7 mm / 0.24 ... 0.28 inch	

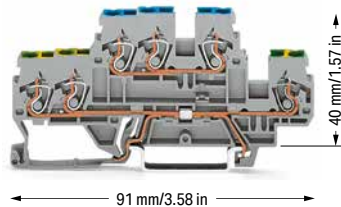

3-conductor double-deck terminal block; ground conductor/through terminal block; gray		
	Item No.	Pack. Unit
○ PE/N	870-535	50
○ PE/L	870-536	50

3-conductor double-deck terminal block; 6-conductor ground terminal block; internally commoned; green-yellow		
	Item No.	Pack. Unit
● PE	870-537	50

- ① Max. insulation diameter: 4.4 mm
- ② 500 V = rated voltage
6 kV = rated impulse voltage
3 = pollution degree (see Section 15)

③ Terminal blocks with a blue insulated housing are suitable for Ex i applications.

See application notes for:
Insulation stop, page 382
Group marker carrier, page 471

Approvals and corresponding ratings, visit www.wago.com

Accessories; 870 Series

Appropriate marking systems:
Mini-WSB/Mini-WSB Inline/WMB/WMB Inline

End and intermediate plate; 2 mm thick			
	orange	870-574	100 (25)
	gray	870-573	100 (25)

Insulation stop; 0.08 ... 0.2 mm ² "s" (0.14 mm ² "f-st"); 5 pcs/strip			
	white	280-470	200 (25)

Insulation stop; 0.25 ... 0.5 mm ² ; 5 pcs/strip			
	light gray	280-471	200 (25)

Insulation stop; 0.75 ... 1 mm ² ; 5 pcs/strip			
	dark gray	280-472	200 (25)

Protective warning marker; with black high-voltage symbol; for 5 terminal blocks			
	yellow	280-405	100 (25)

Push-in type jumper bar; insulated; I_N 18 A; light gray			
	2-way	870-402	200 (25)
	3-way	870-403	200 (25)
	4-way	870-404	100 (25)
	5-way	870-405	100 (25)
	6-way	870-406	100 (25)
	7-way	870-407	100 (25)
	8-way	870-408	100 (25)
	9-way	870-409	100 (25)
	10-way	870-410	50 (25)

Push-in type jumper bar; insulated; I_N 18 A; light gray			
	1 to 3	870-433	200 (25)
	1 to 4	870-434	200 (25)
	1 to 5	870-435	100 (25)
	1 to 6	870-436	100 (25)
	1 to 7	870-437	100 (25)
	1 to 8	870-438	100 (25)
	1 to 9	870-439	100 (25)
	1 to 10	870-440	50 (25)

Mini-WSB Inline, plain; 1,700 WMB markers (5 mm)/reel; 5 ... 5.2 mm stretchable			
	white	2009-145	1

Mini-WSB marking card; white; 10 strips with 10 markers/card; 5 mm wide markers			
	plain	248-501	5

Triple-Deck Terminal Block

2.5 (4 "f-st") mm²; 870 Series

Technical Data

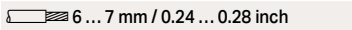
0.08 ... 2.5 (4 "f-st") mm² ① | 28 ... 12 AWG
 500 V/6 kV/3 ② | 300 V, 20 A, $\sqrt{3}$
 I_N 24 A
 Terminal block width: 5 mm / 0.197 inch
 6 ... 7 mm / 0.24 ... 0.28 inch

Technical Data

0.08 ... 2.5 (4 "f-st") mm² ① | 28 ... 12 AWG
 500 V/6 kV/3 ②
 I_N 24 A
 Terminal block width: 5 mm / 0.197 inch
 6 ... 7 mm / 0.24 ... 0.28 inch

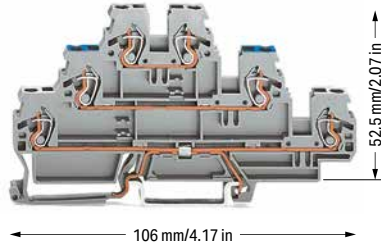
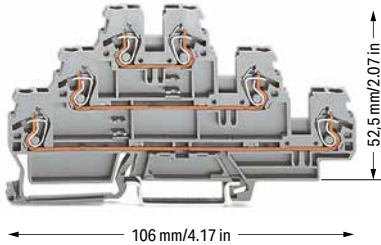

Triple-deck terminal block; through/through/through terminal block; gray

	Item No.	Pack. Unit
○ L/L/L	870-551	50
○ L/L/N	870-553	50

Triple-deck terminal block; through/through/through terminal block; light gray

○ L/L/L ⊕	870-951 ⊕	50
-----------	-----------	----

Triple-deck terminal block; shield conductor/through/through terminal block; gray

	Item No.	Pack. Unit
○ Shield/N/L	870-558	50
○ Shield/L/L	870-559	50

Triple-deck terminal block; ground conductor/through/through terminal block; gray

○ PE/N/L	870-567	50
○ PE/L/L	870-577	50

Triple-deck terminal block; ground conductor/through/through terminal block; light gray

○ PE/L/L ⊕	870-957/999-950 ⊕	50
------------	-------------------	----

Other terminal blocks with the same profile:

Diode	870-590/281-410	Page 474
LED	870-593/281-434	Page 474

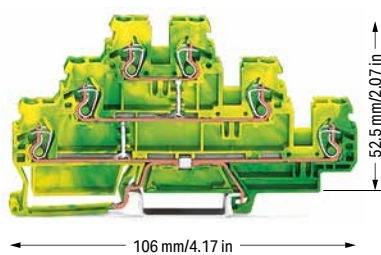
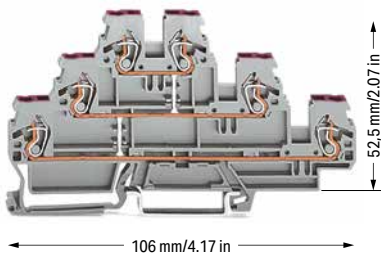

Triple-deck terminal block; 6-conductor through terminal block; internally commoned; Violet conductor entry; gray

	Item No.	Pack. Unit
○ L	870-556	50

Triple-deck terminal block; 6-conductor ground terminal block; internally commoned; green-yellow

● PE	870-557	50
------	---------	----

- Max. insulation diameter: 4.4 mm
 - 500 V = rated voltage
6 kV = rated impulse voltage
3 = pollution degree (see Section 15)
 - Terminal blocks with a blue insulated housing are suitable for Ex i applications.
 - Suitable for Ex e II applications
0.2 ... 2.5 (4 "f-st") mm² / 24 ... 12 AWG
440 V; 22 A (see Section 15)
Using one or more push-in type jumper bars, the maximum rated voltage is reduced to 275 V and the rated current to 13.5 A.
- See application notes for:
Insulation stop, page 382
Group marker carrier, page 471
- Approvals and corresponding ratings, visit www.wago.com

Accessories; 870 Series

- Appropriate marking systems:
Mini-WSB/Mini-WSB Inline/WMB/WMB Inline
- End and intermediate plate; 2 mm thick
- | | | |
|--------|---------|----------|
| orange | 870-569 | 100 (25) |
| gray | 870-568 | 100 (25) |

Insulation stop; 0.08 ... 0.2 mm² "s" (0.14 mm² "f-st"); 5 pcs/strip

white	280-470	200 (25)
-------	---------	----------

Insulation stop; 0.25 ... 0.5 mm²; 5 pcs/strip

light gray	280-471	200 (25)
------------	---------	----------

Insulation stop; 0.75 ... 1 mm²; 5 pcs/strip

dark gray	280-472	200 (25)
-----------	---------	----------

Protective warning marker; with black high-voltage symbol; for 5 terminal blocks

yellow	280-405	100 (25)
--------	---------	----------

Push-in type jumper bar; insulated; I_N 18 A; light gray

2-way	870-402	200 (25)
3-way	870-403	200 (25)
4-way	870-404	200 (25)
5-way	870-405	100 (25)
6-way	870-406	100 (25)
7-way	870-407	100 (25)
8-way	870-408	100 (25)
9-way	870-409	100 (25)
10-way	870-410	50 (25)

Push-in type jumper bar; insulated; I_N 18 A; light gray

1 to 3	870-433	200 (25)
1 to 4	870-434	200 (25)
1 to 5	870-435	100 (25)
1 to 6	870-436	100 (25)
1 to 7	870-437	100 (25)
1 to 8	870-438	100 (25)
1 to 9	870-439	100 (25)
1 to 10	870-440	50 (25)

Mini-WSB Inline, plain; 1,700 WMB markers (5 mm)/reel; 5 ... 5.2 mm stretchable

white	2009-145	1
-------	----------	---

Group Marker Carrier, Marking Strip and Push-In Type Jumper Bar



Group marker carrier; fits into the jumper slot of the current bars
Module width: 5 mm

Color	Item No.	Pack. Unit
<input type="radio"/> gray	870-184	50 (25)

Group marker carrier; fits into the jumper slot of the current bars
Module width: 10 mm

<input type="radio"/> gray	870-183	50 (25)
----------------------------	---------	---------

Group marker carrier; fits into the jumper slot of the current bars
Module width: 15 mm

<input type="radio"/> gray	870-182	50 (25)
----------------------------	---------	---------



Marking strip; plain; 7.5 mm wide; 1 m long

Color	Item No.	Pack. Unit
translucent	709-196	50 (25)



In addition to the plastic marker strips, group marker carriers are now available for the WMB and WSB marking systems. They can be mounted in parallel to a push-in type jumper bar via the open jumper contact slot. It is also very useful if the marker slots on the side of the terminal block are hidden. The carriers are available in the following widths: 5 mm (0.197 inch), 10 mm (0.394 inch) and 15 mm (0.591 inch).

Notice:

Group marker carriers are not suitable for ground conductor terminal blocks and double potential terminal blocks as they have no jumper contact slots.



Ready-made push-in type jumper bar; insulated; I_N 18 A; light gray

	Item No.	Pack. Unit
<input type="radio"/> 1-3-5	870-405/011-000	200 (25)
<input type="radio"/> 1-3-5-7	870-407/011-000	200 (25)
<input type="radio"/> 1-3-5-7-9	870-409/011-000	100 (25)



Delta jumper; insulated; 1-2-3-4-5-6; I_N 18 A

Color	Item No.	Pack. Unit
<input type="radio"/> light gray	870-406/020-000	100 (25)

Double-Deck Diode Terminal Block and LED Terminal Block 2.5 (4 "f-st") mm²; 870 Series

Technical Data

0.08 ... 2.5 (4 "f-st") mm² ① | 28 ... 12 AWG

U_N 250 V; U_{RM} 1000 V

1N4007 – 0.5 A continuous current

Terminal block width: 5 mm / 0.197 inch

6 ... 7 mm / 0.24 ... 0.28 inch

Technical Data

0.08 ... 2.5 (4 "f-st") mm² ① | 28 ... 12 AWG

U_N 250 V; U_{RM} 1000 V

1N4007 – 0.5 A continuous current

Terminal block width: 5 mm / 0.197 inch

6 ... 7 mm / 0.24 ... 0.28 inch

Technical Data

0.08 ... 2.5 (4 "f-st") mm² ① | 28 ... 12 AWG

24 VDC

I_F 0.025 A max.

Terminal block width: 5 mm / 0.197 inch

6 ... 7 mm / 0.24 ... 0.28 inch

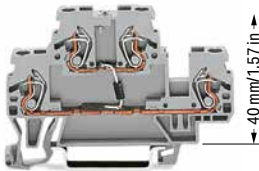

70 mm/2.76 in

870-540/281-410

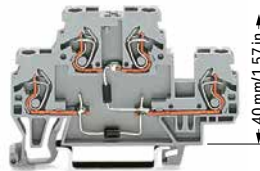

70 mm/2.76 in

870-541/281-491

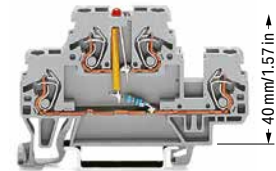

70 mm/2.76 in

870-543/281-413

870-543/281-434

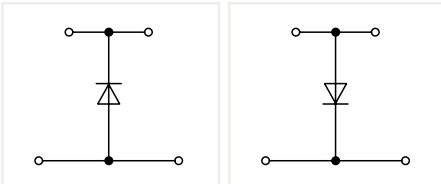

Double-deck diode terminal block; with 1N4007 diode

	Item No.	Pack. Unit
○ anode bottom	870-540/281-410	50
○ anode top	870-540/281-411	50

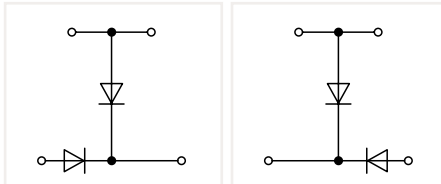

Double-deck diode terminal block; with two 1N4007 diodes

	Item No.	Pack. Unit
○ anode top, anode left	870-541/281-492	50
○ anode top, anode right	870-541/281-491	50

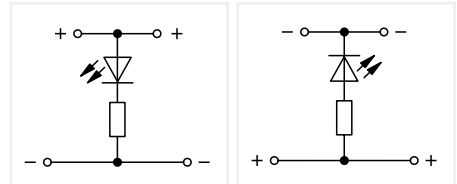

Double-deck LED terminal block; with red LED

	Item No.	Pack. Unit
○ anode top	870-543/281-413	50
○ anode bottom	870-543/281-434	50

Other terminal blocks with the same profile:

Through	870-501	Page 468
---------	---------	----------

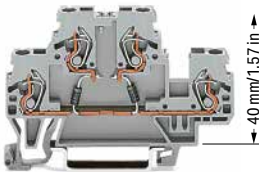

70 mm/2.76 in

870-542/281-487

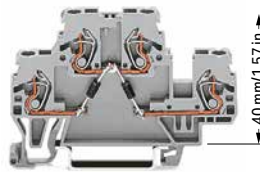

70 mm/2.76 in

870-541/281-489

870-541/281-490

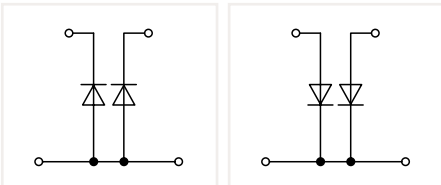

Double-deck diode terminal block; with two 1N4007 diodes

	Item No.	Pack. Unit
○ anodes bottom	870-542/281-487	50
○ anodes top	870-542/281-488	50

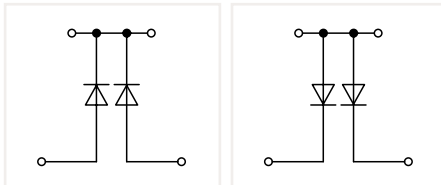

Double-deck diode terminal block; with two 1N4007 diodes

	Item No.	Pack. Unit
○ anodes bottom	870-541/281-489	50
○ anodes top	870-541/281-490	50

Double-Deck Diode Terminal Blocks and LED Terminal Blocks Circuit Configuration Examples

1 Max. insulation diameter: 4.4 mm

See application notes for:
Insulation stop, page 382
Group marker carrier, page 471

Approvals and corresponding ratings,
visit www.wago.com

Accessories: 870 Series

Appropriate marking systems:
Mini-WSB/Mini-WSB Inline/WMB/WMB Inline

End and intermediate plate, 2 mm thick

	orange	870-519	100 (25)
	gray	870-518	100 (25)

Insulation stop; 0.08 ... 0.2 mm² "s" (0.14 mm² "f-st"); 5 pcs/strip

	white	280-470	200 (25)
---	-------	---------	----------

Insulation stop; 0.25 ... 0.5 mm²; 5 pcs/strip

	light gray	280-471	200 (25)
---	------------	---------	----------

Insulation stop; 0.75 ... 1 mm²; 5 pcs/strip

	dark gray	280-472	200 (25)
---	-----------	---------	----------

Protective warning marker; with black high-voltage symbol; for 5 terminal blocks

	yellow	280-405	100 (25)
---	--------	---------	----------

Push-in type jumper bar; insulated; I_n 18 A; light gray

	2-way	870-402	200 (25)
	3-way	870-403	200 (25)
	4-way	870-404	100 (25)
	5-way	870-405	100 (25)
	6-way	870-406	100 (25)
	7-way	870-407	100 (25)
	8-way	870-408	100 (25)
	9-way	870-409	100 (25)
	10-way	870-410	50 (25)

Push-in type jumper bar; insulated; I_n 18 A; light gray

	1 to 3	870-433	200 (25)
	1 to 4	870-434	200 (25)
	1 to 5	870-435	100 (25)
	1 to 6	870-436	100 (25)
	1 to 7	870-437	100 (25)
	1 to 8	870-438	100 (25)
	1 to 9	870-439	100 (25)
	1 to 10	870-440	50 (25)

Marking strip; plain; 7.5 mm wide; 1 m long

	translucent	709-196	1
---	-------------	---------	---

Mini-WSB Inline, plain; 1,700 WMB markers (5 mm)/reel; 5 ... 5.2 mm stretchable

	white	2009-145	1
---	-------	----------	---

Mini-WSB marking card; white; 10 strips with 10 markers/ card; 5 mm wide markers

	plain	248-501	5
---	-------	---------	---

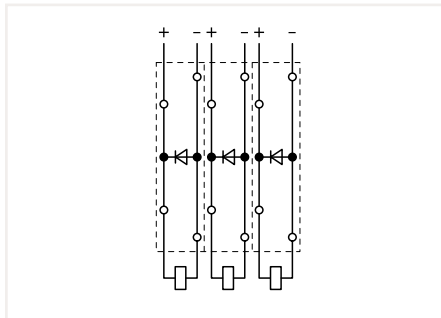

Recovery diodes can be created using the following terminal blocks:
870-540/281-410 or 870-540/281-411

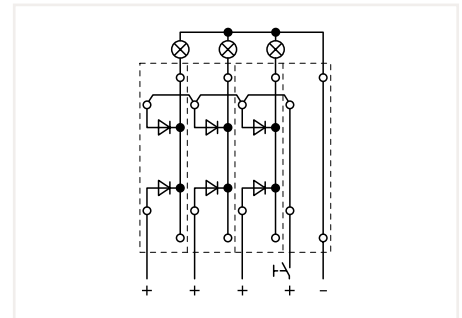

Lamp test circuits can be created using the following terminal blocks:
870-542/281-487 or 870-542/281-488

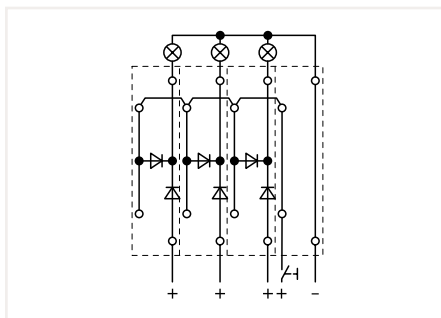

Lamp test circuits can be created using the following terminal blocks:
870-541/281-492 or 870-541/281-491

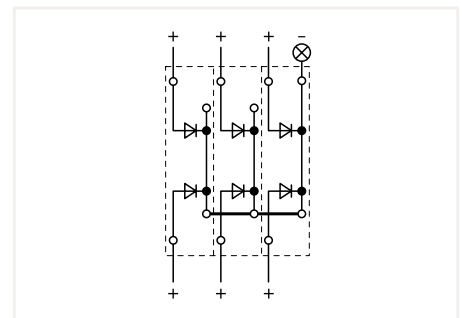

Collective fault signals can be created using the following terminal blocks:
870-541/281-489 or 870-541/281-490

Double-deck diode terminal blocks were specifically developed for custom diode circuits, such as lamp test and collective fault signal circuits. Using LED terminal blocks, monitoring units can be designed, e.g., for control and operating circuits. These terminal blocks provide high-density wiring in a width of just 5 mm.

Push-in type jumper bars provide additional options for custom circuit design.

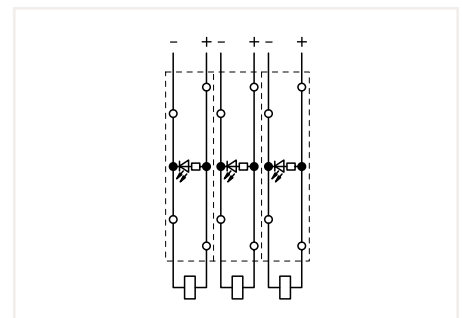

Circuit-related voltage indications can be created using the following terminal blocks:
870-543/281-434 or 870-543/281-413

Triple-Deck Diode Terminal Block and LED Terminal Block 2.5 (4 "f-st") mm²; 870 Series

Technical Data

0.08 ... 2.5 (4 "f-st") mm² ① | 28 ... 12 AWG

U_N 250 V; U_{RM} 1000 V

1N4007 – 0.5 A continuous current

Terminal block width: 5 mm / 0.197 inch

6 ... 7 mm / 0.24 ... 0.28 inch

Technical Data

0.08 ... 2.5 (4 "f-st") mm² ① | 28 ... 12 AWG

U_N 250 V; U_{RM} 1000 V

1N4007 – 0.5 A continuous current

Terminal block width: 5 mm / 0.197 inch

6 ... 7 mm / 0.24 ... 0.28 inch

Technical Data

0.08 ... 2.5 (4 "f-st") mm² ① | 28 ... 12 AWG

24 VDC

I_f 0.025 A max.

Terminal block width: 5 mm / 0.197 inch

6 ... 7 mm / 0.24 ... 0.28 inch

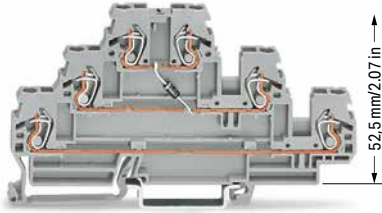

106 mm/4.17 in

280-590/281-410

280-590/281-411

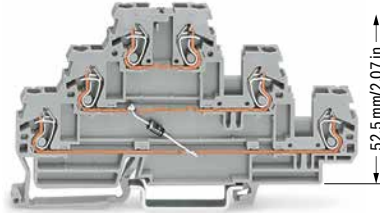

106 mm/4.17 in

280-590/281-675

280-590/281-676

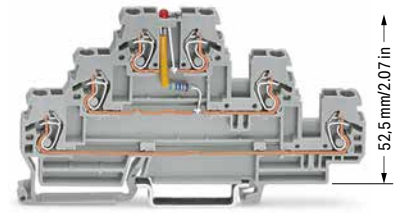

106 mm/4.17 in

280-593/281-434

280-593/281-413

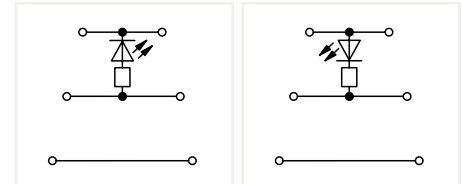
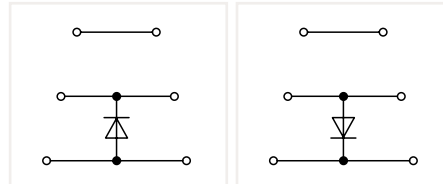
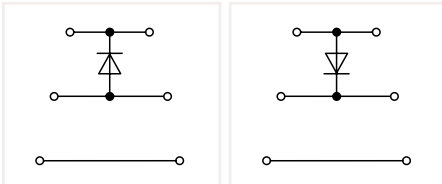

Triple-deck diode terminal block; with 1N4007 diode

	Item No.	Pack. Unit
○ anode bottom	870-590/281-410	50
○ anode top	870-590/281-411	50

Triple-deck diode terminal block; with two 1N4007 diodes

	Item No.	Pack. Unit
○ anode bottom	870-590/281-675	50
○ anode top	870-590/281-676	50

Triple-deck LED terminal block; with red LED

	Item No.	Pack. Unit
○ anode bottom	870-593/281-434	50
○ anode top	870-593/281-413	50

Other terminal blocks with the same profile:

Through	870-551	Page 470
---------	---------	----------

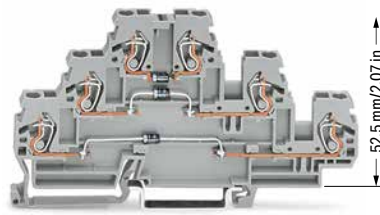

106 mm/4.17 in

280-596/281-673

280-596/281-674

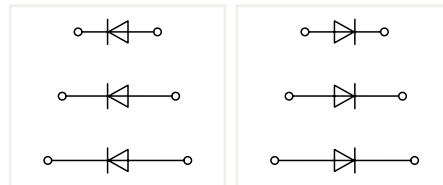

Triple-deck diode terminal block; with two 1N4007 diodes

	Item No.	Pack. Unit
○ anodes right	870-596/281-673	50
○ anodes left	870-596/281-674	50

8

1 Max. insulation diameter: 4.4 mm

See application notes for:
Insulation stop, page 382
Group marker carrier, page 471

Approvals and corresponding ratings,
visit www.wago.com

Accessories; 870 Series

Appropriate marking systems:
Mini-WSB/Mini-WSB Inline/WMB/WMB Inline

End and intermediate plate; 2 mm thick



orange	870-569	100 (25)
gray	870-568	100 (25)

Insulation stop; 0.08 ... 0.2 mm² "s" (0.14 mm² "f-st"); 5 pcs/strip



white	280-470	200 (25)
-------	---------	----------

Insulation stop; 0.25 ... 0.5 mm²; 5 pcs/strip



light gray	280-471	200 (25)
------------	---------	----------

Insulation stop; 0.75 ... 1 mm²; 5 pcs/strip



dark gray	280-472	200 (25)
-----------	---------	----------

Protective warning marker; with black high-voltage symbol; for 5 terminal blocks



yellow	280-405	100 (25)
--------	---------	----------

Push-in type jumper bar; insulated; I_N 18 A; light gray



2-way	870-402	200 (25)
3-way	870-403	200 (25)
4-way	870-404	100 (25)
5-way	870-405	100 (25)
6-way	870-406	100 (25)
7-way	870-407	100 (25)
8-way	870-408	100 (25)
9-way	870-409	100 (25)
10-way	870-410	50 (25)

Push-in type jumper bar; insulated; I_N 18 A; light gray



1 to 3	870-433	200 (25)
1 to 4	870-434	200 (25)
1 to 5	870-435	100 (25)
1 to 6	870-436	100 (25)
1 to 7	870-437	100 (25)
1 to 8	870-438	100 (25)
1 to 9	870-439	100 (25)
1 to 10	870-440	50 (25)

Marking strip; plain; 7.5 mm wide; 1 m long



translucent	709-196	1
-------------	---------	---

Mini-WSB Inline, plain; 1,700 WMB markers (5 mm)/reel; 5 ... 5.2 mm stretchable



white	2009-145	1
-------	----------	---

Mini-WSB marking card; white; 10 strips with 10 markers/card; 5 mm wide markers



plain	248-501	5
-------	---------	---

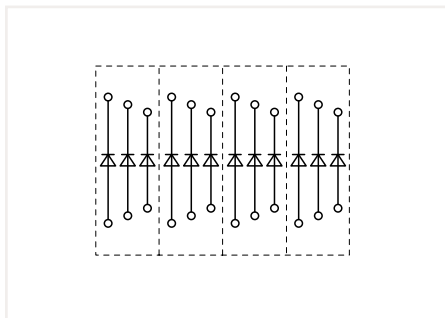

Triple-deck diode terminal blocks were specifically developed for custom diode circuits, such as lamp test and collective fault signal circuits.

Using LED terminal blocks, monitoring units can be designed, e.g., for control and operating circuits.

These terminal blocks provide high-density wiring in a width of just 5 mm.

Push-in type jumper bars provide additional options for custom circuit design.

Pluggable Tap-Off Modules 870 Series Description and Installation

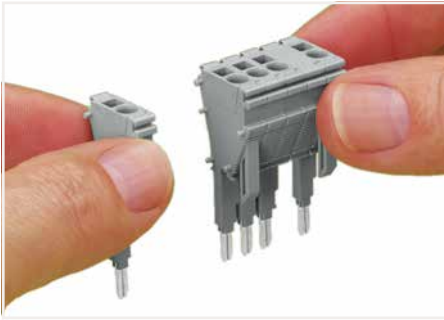

Snapping tap-off and spacer modules together to assemble a multipole tap-off module (max. 10 poles).



Module assembly with CAGE CLAMP® connections (0.25 ... 2.5 mm²/24 ... 14 AWG), including strain relief plate and marker slots for Mini-WSB or WMB markers.

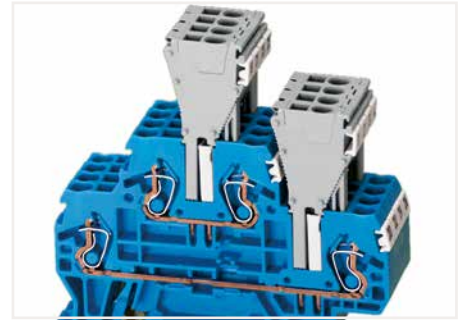

The tap-off module assembly can be directly plugged into the jumper contact slot of the current bar. The terminal blocks can also be commoned via push-in type jumper bars parallel to the jumper slots being used by the modules.



CAGE CLAMP® termination:
Tap-off modules are used when additional or removable connections are required (can be used as a permanent connection or a test plug). Wiring is possible whether the modules are plugged into the assembly or not.

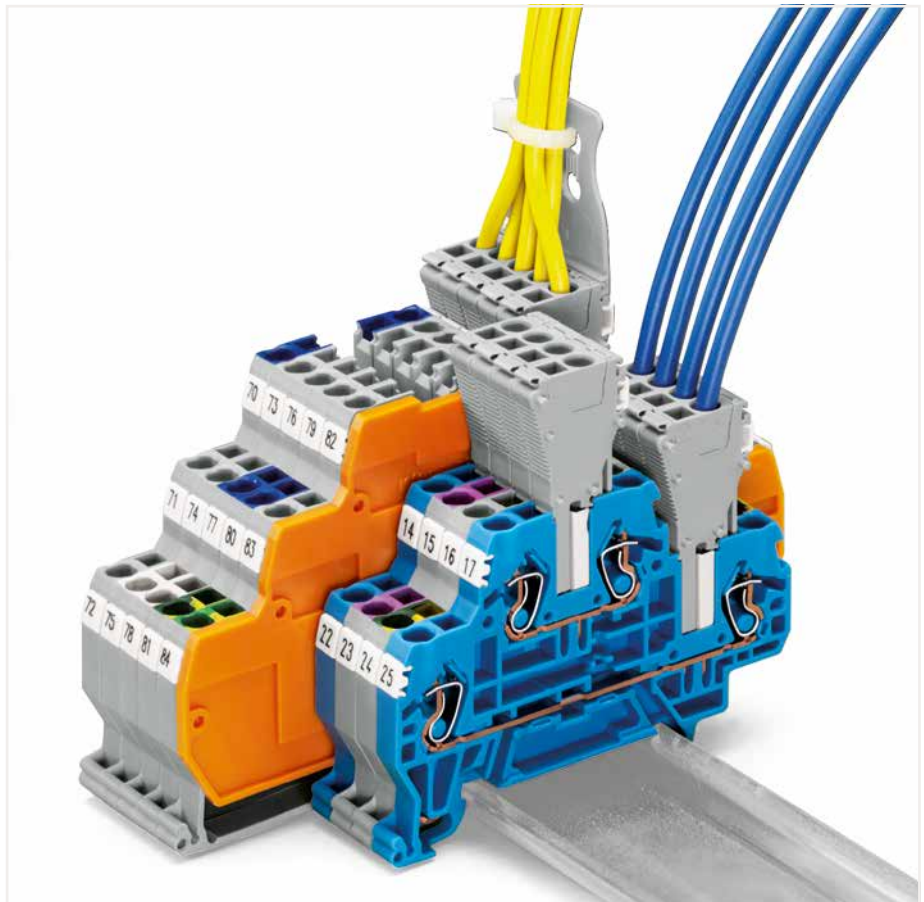

8

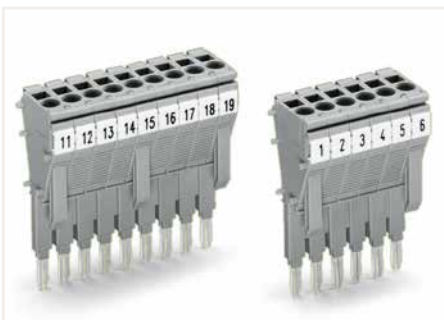

Using anti-reverse mating modules at both ends of a module assembly prevents reverse mating.



Three anti-reverse mating modules are necessary when snapping more than seven tap-off modules together.

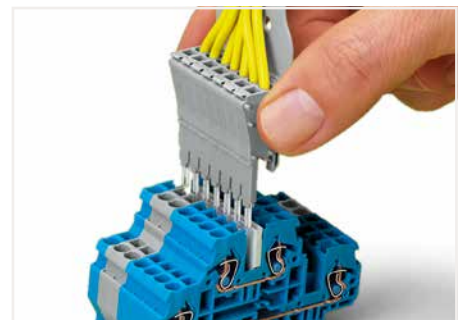

Testing is also possible using a pre-wired tap-off module assembly in the very same way as test plugs.



CAGE CLAMP® terminates the following copper conductors: solid "s"



stranded "st"



fine-stranded "f-st", also with tinned single strands

Pluggable Tap-Off Module 870 Series

Technical Data	
0.25 ... 2.5 mm ²	22 ... 14 AWG
500 V/6 kV/3 ①	
I _N 18 A	
Module width: 5 mm / 0.197 inch	
 10 mm / 0.38 inch	



Technical Data	
0.25 ... 2.5 mm ²	22 ... 14 AWG
500 V/6 kV/3 ①	
I _N 10 A	
Module width: 5 mm / 0.197 inch	
 10 mm / 0.38 inch	



- ① 500 V = rated voltage
6 kV = rated impulse voltage
3 = pollution degree
(see Section 15)

Approvals and corresponding ratings,
visit www.wago.com

Pluggable tap-off module; with anti-reverse mating protection; snaps together; for 870 Series Rail-Mount Terminal Blocks with jumper slots in the current bar

Color	Item No.	Pack. Unit
<input type="radio"/> gray	870-425	100 (25)

Pluggable tap-off module; snaps together; for 870 Series Rail-Mount Terminal Blocks with jumper slots in the current bar

Color	Item No.	Pack. Unit
<input type="radio"/> gray	870-426	100 (25)

Spacer module; snaps together; bridges terminal blocks

<input type="radio"/> gray	870-427	100 (25)
----------------------------	---------	----------

Accessories; for pluggable tap-off modules

Appropriate marking systems: Mini-WSB/Mini-WSB Inline/WMB/WMB Inline

Strain relief plate; gray



35 mm wide	734-326	100 (25)
6 mm wide	734-327	100 (25)
12.5 mm wide	734-328	100 (25)
25 mm wide	734-329	100 (25)

Mini-WSB marking card; white; 10 strips with 10 markers/card; 5 mm wide markers

 plain	248-501	5
---	---------	---

WMB marking card; white; 10 strips with 10 markers/card; stretchable 5 ... 5.2 mm

 plain	793-5501	5
---	----------	---

WMB marking card; white; 10 strips with 10 markers/card; for 5 ... 17.5 mm terminal block width

 plain	793-501	5
---	---------	---

Sensor Terminal Blocks and Actuator Terminal Blocks

270 Series

Description and Installation

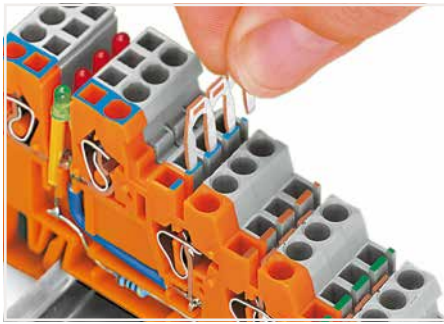

Inserting a jumper.

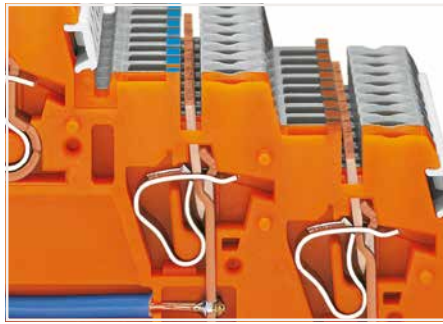

Commoning a supply voltage using unshielded push-in type jumper bars, 2- to 9-way or 17-way (2 x 8 bits), depending on application.



Commoning signal level voltage via insulated push-in type jumper bars (870 Series) – 2- to 9-way, depending on application. Sensor LED terminal blocks cannot be commoned!



Terminal block assembly:
Sensor terminal blocks

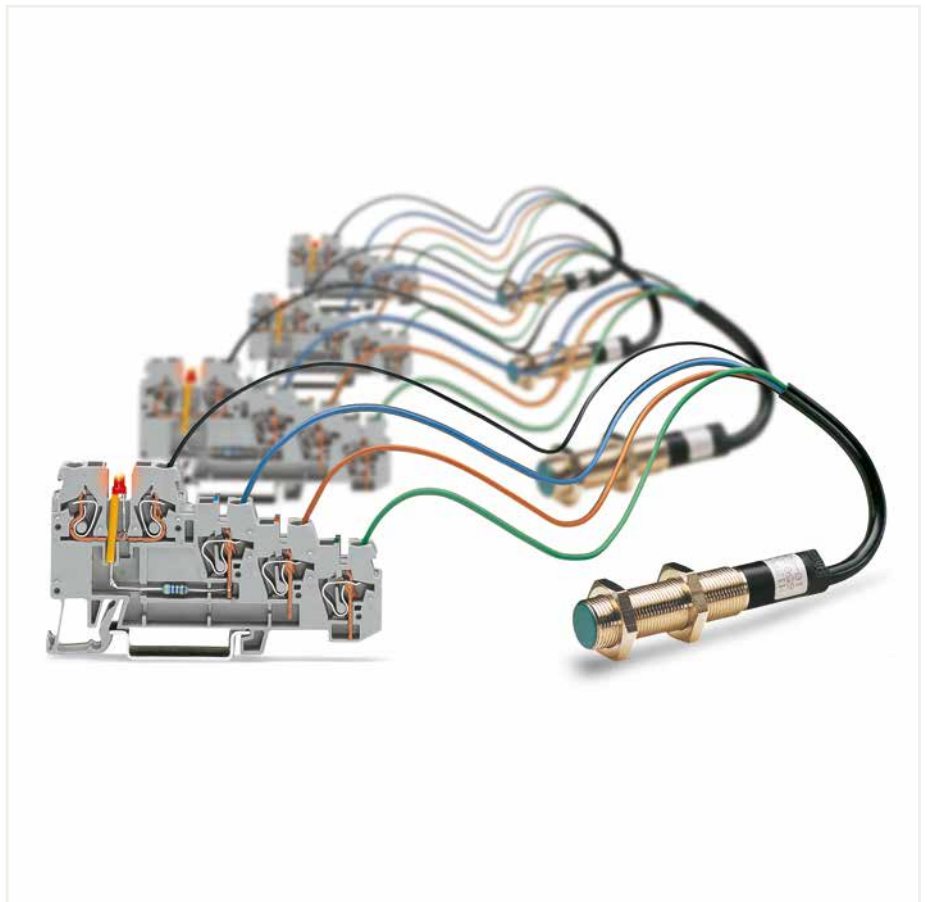

Sensor LED terminal block



Terminal block assembly:
Sensor LED terminal blocks



Marking strip (Item No. 709-196)
Not suitable for LED terminal blocks!

CAGE CLAMP® terminates the following copper conductors:
solid "s" stranded "st"

fine-stranded "f-st", also with tinned single strands

fine-stranded, tip-bonded

fine-stranded, with ferrule (gastight crimped)

fine-stranded, with pin terminal (gastight crimped)

With ferruled conductors, it is necessary to use a terminal block one size smaller than the conductor's nominal cross section.

8

4-Conductor Sensor Terminal Block and 4-Conductor Sensor LED Terminal Block 2.5 mm²; 270 Series

Technical Data	
0.08 ... 2.5 mm ²	28 ... 12 AWG*
250 V/4 kV/3 ①	300 V, 20 A ②
I _N 18 A ②	300 V, 10 A ③
Terminal block width: 5 mm / 0.197 inch	
6 ... 7 mm / 0.24 ... 0.28 inch	

Technical Data	
0.08 ... 2.5 mm ²	28 ... 12 AWG*
24 VDC ③	
Terminal block width: 5 mm / 0.197 inch	
6 ... 7 mm / 0.24 ... 0.28 inch	

- *12 AWG: THHN, THWN
 - ① 250 V = rated voltage
4 kV = rated impulse voltage
3 = pollution degree (see Section 15)
 - ② Internal bridge: 9 A
 - ③ Other voltages are available upon request.
LED power consumption: 4.8 mA
- See application notes for:
Insulation stop, page 382
Marking, from page 640
- Approvals and corresponding ratings, visit www.wago.com

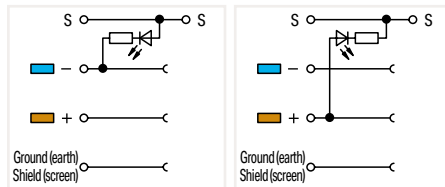
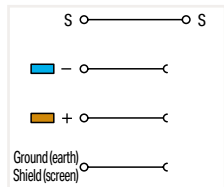
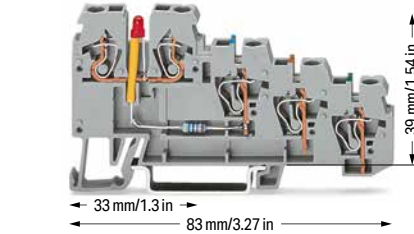
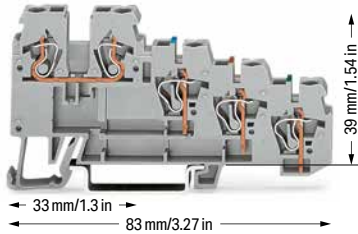

4-conductor sensor terminal block		
Color	Item No.	Pack. Unit
gray	270-570	50

4-conductor sensor LED terminal block; for PNP (high-side) switching sensors; Red LED		
Color	Item No.	Pack. Unit
gray	270-570/281-434	50

4-conductor sensor LED terminal block; for NPN (low-side) switching sensors; Yellow LED		
Color	Item No.	Pack. Unit
gray	270-570/281-507	50

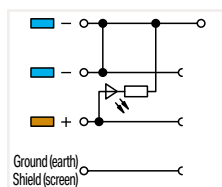
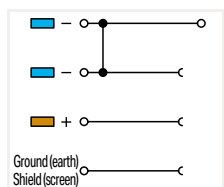
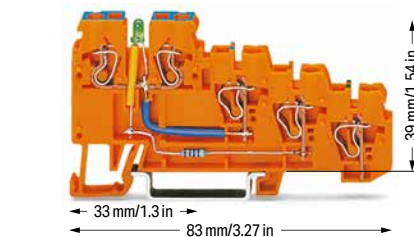
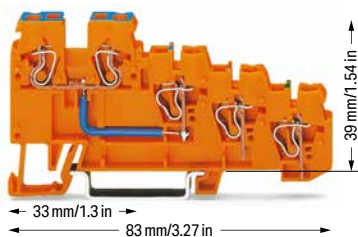

4-conductor sensor supply terminal block; Internal bridge: 9 A		
Color	Item No.	Pack. Unit
orange	270-574	10

4-conductor sensor LED supply terminal block; Green LED		
Color	Item No.	Pack. Unit
orange	870-574/281-483	10

Accessories; 870 Series
Appropriate marking systems:
Mini-WSB/Mini-WSB Inline/WMB/WMB Inline

End and intermediate plate; 1 mm thick; for quadruple-deck terminal blocks

orange	270-322	100 (25)
gray	270-320	100 (25)

Insulation stop; 0.08 ... 0.2 mm² "s" (0.14 mm² "f-st"); 5 pcs/strip

white	280-470	200 (25)
-------	---------	----------

Insulation stop; 0.25 ... 0.5 mm²; 5 pcs/strip

light gray	280-471	200 (25)
------------	---------	----------

Insulation stop; 0.75 ... 1 mm²; 5 pcs/strip

dark gray	280-472	200 (25)
-----------	---------	----------

Push-in type jumper bar; uninsulated; I_N 18 A
Jumpers can be shortened using an electronic side cutter.

9-way	270-409	200 (25)
17-way	270-417	200 (25)
80-way	270-480	100 (25)

Push-in type jumper bar; insulated; I_N 18 A; light gray

2-way	870-402	200 (25)
3-way	870-403	200 (25)
4-way	870-404	100 (25)
5-way	870-405	100 (25)
6-way	870-406	100 (25)
7-way	870-407	100 (25)
8-way	870-408	100 (25)
9-way	870-409	50 (25)

Mini-WSB marking card; white; 10 strips with 10 markers/card; 5 mm wide markers

plain	248-501	5
-------	---------	---

WMB marking card; white; 10 strips with 10 markers/card; stretchable 5 ... 5.2 mm

plain	793-5501	5
-------	----------	---

Operating tool with a partially insulated shaft; Type 2; (3.5 x 0.5) mm blade

	210-720	1
--	---------	---

3-Conductor Sensor Terminal Block and 3-Conductor Sensor LED Terminal Block 2.5 mm²; 270 Series

Technical Data	
0.08 ... 2.5 mm ²	28 ... 12 AWG*
250 V/4 kW/3 ①	300 V, 20 A ②
I _N 18 A ②	300 V, 10 A ③
Terminal block width: 5 mm / 0.197 inch	
6 ... 7 mm / 0.24 ... 0.28 inch	

Technical Data	
0.08 ... 2.5 mm ²	28 ... 12 AWG*
24 VDC ③	
Terminal block width: 5 mm / 0.197 inch	
6 ... 7 mm / 0.24 ... 0.28 inch	

Technical Data	
0.08 ... 2.5 mm ²	28 ... 12 AWG*
24 VDC ③	
Terminal block width: 5 mm / 0.197 inch	
6 ... 7 mm / 0.24 ... 0.28 inch	

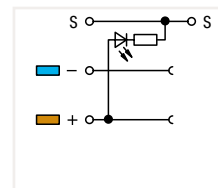
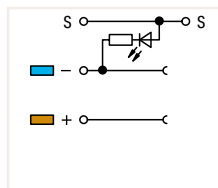
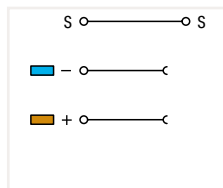
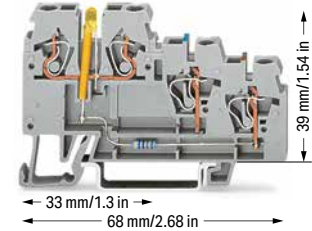
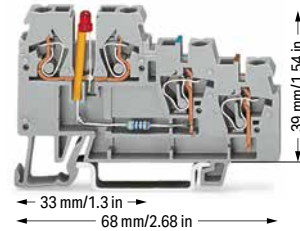
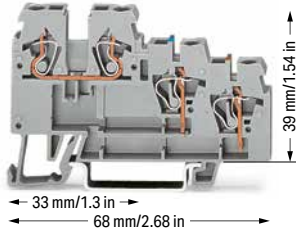

3-conductor sensor terminal block		
Color	Item No.	Pack. Unit
○ gray	270-560	50

3-conductor sensor LED terminal block; for PNP (high-side) switching sensors; Red LED		
Color	Item No.	Pack. Unit
○ gray	270-560/281-434	50

3-conductor sensor LED terminal block; for NPN (low-side) switching sensors; Yellow LED		
Color	Item No.	Pack. Unit
○ gray	270-560/281-507	50

8

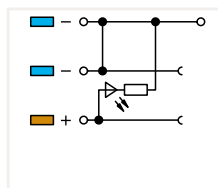
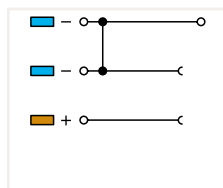
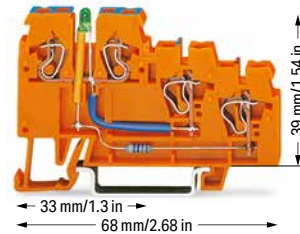
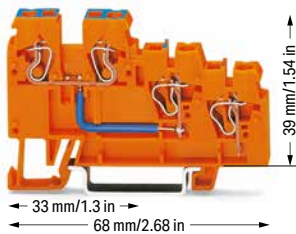

3-conductor sensor supply terminal block; Internal bridge: 9 A		
Color	Item No.	Pack. Unit
○ gray	270-564	10

3-conductor sensor LED supply terminal block; Green LED		
Color	Item No.	Pack. Unit
○ gray	270-564/281-483	10

Pluggable tap-off modules (Item No. 870-425, 870-426, 870-427) can be used on the signal level.

3-Conductor Actuator Terminal Block and 3-Conductor Actuator LED Terminal Block 2.5 mm²; 270 Series

Technical Data	
0.08 ... 2.5 mm ²	28 ... 12 AWG*
250 V/4 kV/3 ①	300 V, 20 A ②
I _N 18 A ②	300 V, 10 A ③
Terminal block width: 5 mm / 0.197 inch	
6 ... 7 mm / 0.24 ... 0.28 inch	

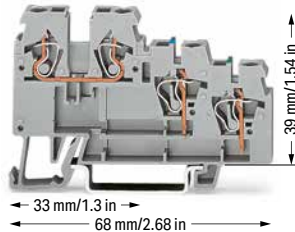

270-572

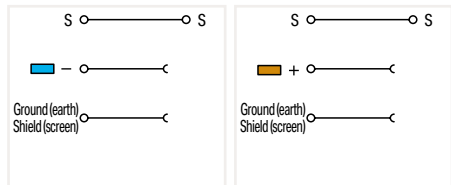

3-conductor actuator terminal block

Color	Item No.	Pack. Unit
gray	270-572	50

3-conductor actuator terminal block

gray	270-585	50
------	---------	----

Technical Data	
0.08 ... 2.5 mm ²	28 ... 12 AWG*
24 VDC ③	
Terminal block width: 5 mm / 0.197 inch	
6 ... 7 mm / 0.24 ... 0.28 inch	

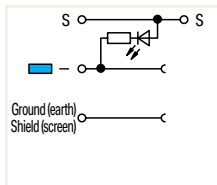
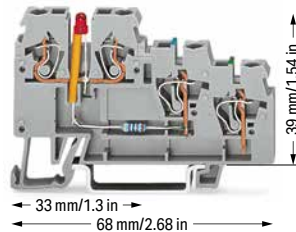

3-conductor actuator LED terminal block; for PNP (high-side) switching actuators; Red LED

Color	Item No.	Pack. Unit
gray	270-572/281-434	50

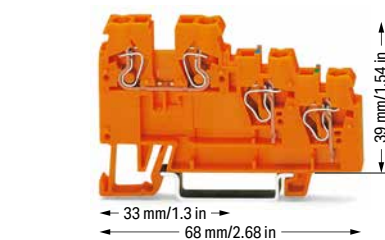

270-577

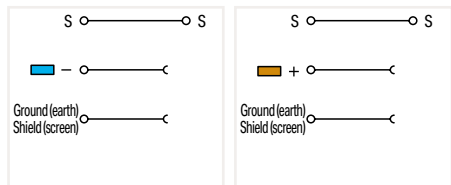

3-conductor actuator supply terminal block

Color	Item No.	Pack. Unit
orange	270-577	10

3-conductor actuator supply terminal block

orange	270-586	10
--------	---------	----

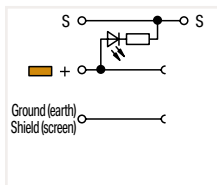
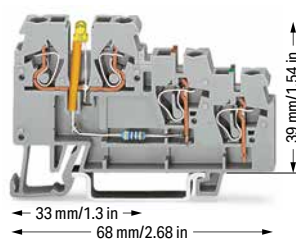

3-conductor actuator LED terminal block; for NPN (low-side) switching actuators; Yellow LED

Color	Item No.	Pack. Unit
gray	270-585/281-507	50

*12 AWG: THHN, THWN

① 250 V = rated voltage
4 kV = rated impulse voltage
3 = pollution degree
(see Section 15)

② Other voltages are available upon request.
LED power consumption: 4.8 mA

See application notes for:
Insulation stop, page 382
Marking, from page 640

Approvals and corresponding ratings,
visit www.wago.com

Accessories; 870 Series

Appropriate marking systems:
Mini-WSB/Mini-WSB Inline/WMB/WMB Inline

End and intermediate plate; 1 mm thick; for triple-deck terminal blocks

orange	270-321	100 (25)
gray	270-319	100 (25)

Insulation stop; 0.08 ... 0.2 mm² "s" (0.14 mm² "f-st"); 5 pcs/strip

white	280-470	200 (25)
-------	---------	----------

Insulation stop; 0.25 ... 0.5 mm²; 5 pcs/strip

light gray	280-471	200 (25)
------------	---------	----------

Insulation stop; 0.75 ... 1 mm²; 5 pcs/strip

dark gray	280-472	200 (25)
-----------	---------	----------

Push-in type jumper bar; uninsulated; I_N 18 A
Jumpers can be shortened using an electronic side cutter.

9-way	270-409	200 (25)
17-way	270-417	200 (25)
80-way	270-480	100 (25)

Push-in type jumper bar; insulated; I_N 18 A; light gray

2-way	870-402	200 (25)
3-way	870-403	200 (25)
4-way	870-404	100 (25)
5-way	870-405	100 (25)
6-way	870-406	100 (25)
7-way	870-407	100 (25)
8-way	870-408	100 (25)
9-way	870-409	50 (25)

Mini-WSB marking card; white; 10 strips with 10 markers/card; 5 mm wide markers

plain	248-501	5
-------	---------	---

WMB marking card; white; 10 strips with 10 markers/card; stretchable 5 ... 5.2 mm

plain	793-5501	5
-------	----------	---





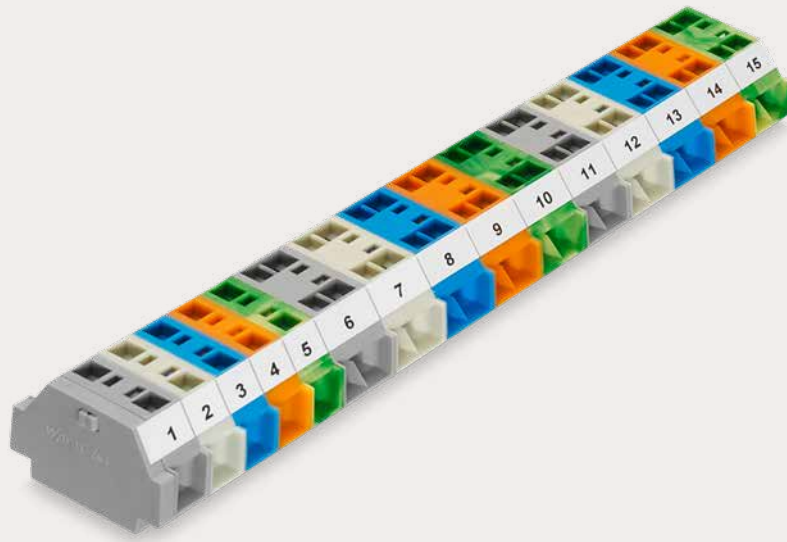

Operating tool with a partially insulated shaft; Type 2; (3.5 x 0.5) mm blade

	210-720	1
--	---------	---



WAGO Modular Terminal Blocks and WAGO Terminal Strips

WAGO Modular Terminal Blocks and WAGO Terminal Strips Side-/Front-Entry Wiring

			Page
	Modular Terminal Blocks and Terminal Strips; with Mounting Flanges or Snap-In Mounting Feet – Front-Entry Wiring 2.5 (4 "f-st") mm ² (12 AWG)	869 Series	485
	Modular Terminal Blocks and Terminal Strips; with Mounting Flanges or Snap-In Mounting Feet – Front-Entry Wiring 2.5 mm ² (14 AWG)	264 Series	490
	Modular Terminal Blocks and Terminal Strips; with Mounting Flanges or Snap-In Mounting Feet – Side-Entry Wiring 0.08 ... 1.5 mm ² (28 ... 16 AWG) / 2.5 mm ² (14 AWG) / 4 mm ² (12 AWG)	260/261/262 Series	496
	Modular Terminal Blocks and Terminal Strips; with Push-Buttons on One or Both Sides 0.08 ... 1.5 mm ² (28 ... 16 AWG)	261 Series	500
	Modular Terminal Blocks and Terminal Strips with Mini-WSB Marker Slot and Push-Buttons on One or Both Sides 1.5 mm ² (16 AWG)	261 Series	504
	Accessories for Modular Terminal Blocks and Terminal Strips	260/261/262 Series	510

Modular Terminal Blocks and Terminal Strips

869 Series

Description and Installation

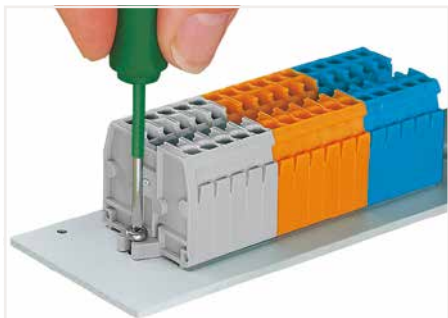

Mounting and securing a terminal strip directly to the plate via screw-type flanges.

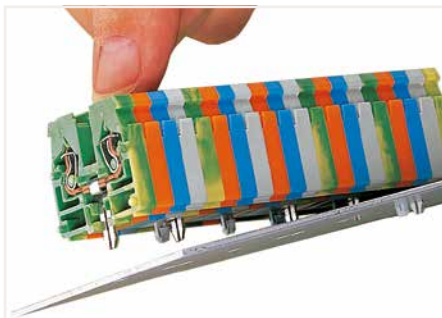

Mounting a terminal strip with snap-in feet into holes.

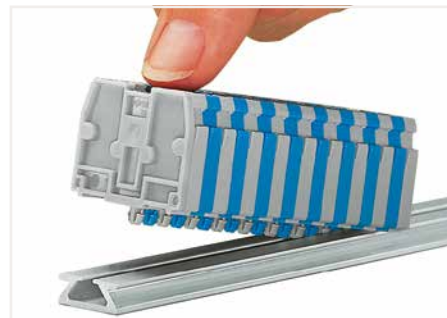

Mounting a terminal strip with snap-in feet onto the aluminum rail.



Terminal strip with mounting flanges:

- End plate with mounting flange ①
- Center terminal blocks ②
- End terminal block with mounting flange ③

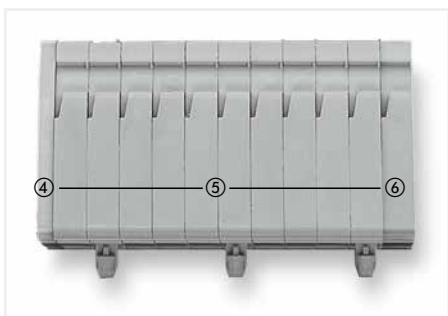

Terminal strip with snap-in mounting feet:

- End plate ④
- Center terminal blocks with/without snap-in mounting feet ⑤
- End terminal block with/without snap-in mounting foot ⑥

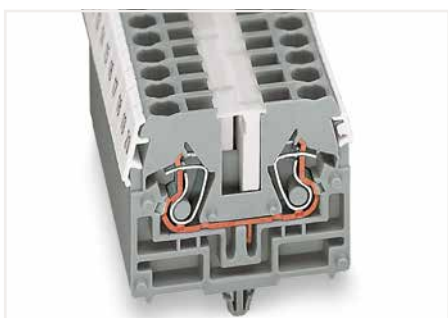

WMB markers in Mini-WSB marker slots
Translucent marking strip
Mini-WSB markers



Push jumper bars down firmly until fully inserted. When using multipole bars, push alternately on the right and then left side until installed.
Push-in type jumper bars 1-3-5-7 or 1-4-7 are available upon request.



Protective warning marker (280-405); with a black high-voltage symbol

CAGE CLAMP® terminates the following copper conductors:
solid "s" stranded "st"

fine-stranded "f-st",
also with tinned
single strands

fine-stranded,
tip-bonded

fine-stranded,
with ferrule
(gastight crimped)

fine-stranded,
with pin terminal
(gastight crimped)

With ferruled conductors, it is necessary to use a terminal block one size smaller than the conductor's nominal cross section.

Compact Terminal Strips; with Mounting Flanges or Snap-in Mounting Feet

2.5 (4 "f-st") mm²; 870 Series

Technical Data	
0.08 ... 2.5 (4 "f-st") mm ²	28 ... 12 AWG
500 V/6 kV/3	300 V, 20 A, I_N
I_N 24 A	
Pole width: 5 mm / 0.197 inch	
6 ... 7 mm / 0.24 ... 0.28 inch	

Technical Data	
0.08 ... 2.5 (4 "f-st") mm ² ①	28 ... 12 AWG
500 V/6 kV/3 ②	300 V, 20 A, I_N
I_N 24 A	
Pole width: 5 mm / 0.197 inch	
6 ... 7 mm / 0.24 ... 0.28 inch	

Technical Data	
0.08 ... 2.5 (4 "f-st") mm ² ①	28 ... 12 AWG
500 V/6 kV/3 ②	300 V, 20 A, I_N
I_N 24 A	
Pole width: 5 mm / 0.197 inch	
6 ... 7 mm / 0.24 ... 0.28 inch	



Compact terminal strip; with M3 mounting flanges; for screw or similar mounting types; 3.2 mm mounting hole diameter; gray		
Pole No.	Item No.	Pack. Unit
○ 2	869-102	100
○ 3	869-103	100
○ 4	869-104	100
○ 5	869-105	100
○ 6	869-106	50
○ 7	869-107	50
○ 8	869-108	50
○ 9	869-109	50
○ 10	869-110	50
○ 11	869-111	25
○ 12 ①	869-112	25

Compact terminal strip; with M4 mounting flanges; for screw or similar mounting types; 4.2 mm mounting hole diameter; gray		
Pole No.	Item No.	Pack. Unit
○ 2	869-202	100
○ 3	869-203	100
○ 4	869-204	100
○ 5	869-205	100
○ 6	869-206	50
○ 7	869-207	50
○ 8	869-208	50
○ 9	869-209	50
○ 10	869-210	25
○ 11	869-211	25
○ 12 ①	869-212	25

Compact terminal strip; with snap-in mounting feet; for 0.6 ... 1.2 mm plate thickness; 3.5 + 0.1 mm mounting hole diameter; gray		
Pole No.	Item No.	Pack. Unit
○ 2	869-152	100
○ 3	869-153	100
○ 4	869-154	100
○ 5	869-155	100
○ 6	869-156	50
○ 7	869-157	50
○ 8	869-158	50
○ 9	869-159	50
○ 10	869-160	25
○ 11	869-161	25
○ 12 ①	869-162	25

light gray		
○ 2	869-132	100
○ 3	869-133	100
○ 4	869-134	100
○ 5	869-135	100
○ 6	869-136	50
○ 7	869-137	50
○ 8	869-138	50
○ 9	869-139	50
○ 10	869-140	25
○ 11	869-141	25
○ 12 ①	869-142	25

light gray		
○ 2	869-232	100
○ 3	869-233	100
○ 4	869-234	100
○ 5	869-235	100
○ 6	869-236	50
○ 7	869-237	50
○ 8	869-238	50
○ 9	869-239	50
○ 10	869-240	25
○ 11	869-241	25
○ 12 ①	869-242	25

light gray		
○ 2	869-182	100
○ 3	869-183	100
○ 4	869-184	100
○ 5	869-185	100
○ 6	869-186	50
○ 7	869-187	50
○ 8	869-188	50
○ 9	869-189	50
○ 10	869-190	25
○ 11	869-191	25
○ 12 ①	869-192	25

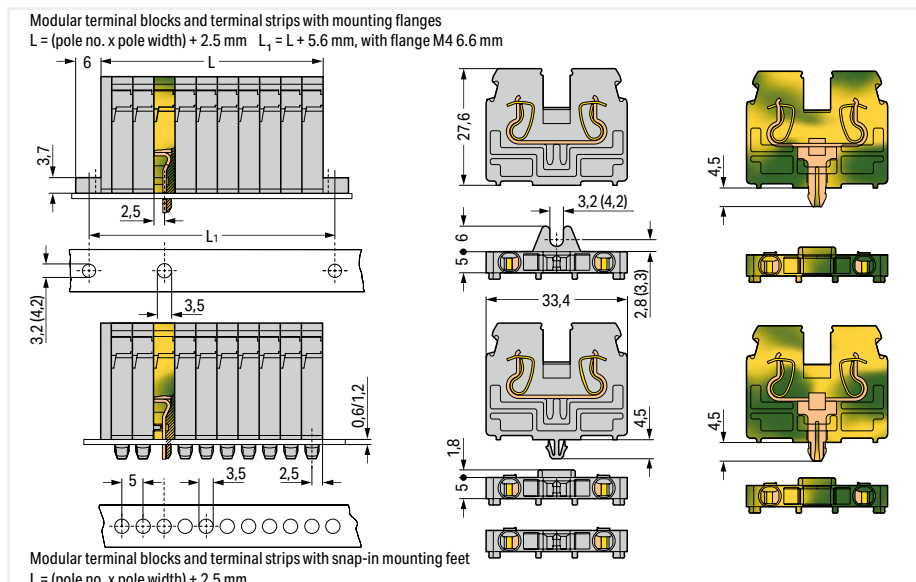

- ① Longer strips and/or mixed-color assemblies are available upon request.
 - ② Terminal strips with a blue insulated housing are suitable for Ex i applications.
- Item no. suffixes for gray terminal strips in:
 blue .../000-006 ②
 green-yellow .../000-016
 869-102 ... 869-112
 869-202 ... 869-212
 869-152 ... 869-162

Dimensions in mm

Modular Terminal Block; with Mounting Flange or Snap-In Mounting Foot 2.5 (4 "f-st") mm²; 870 Series

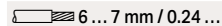
Technical Data	
0.08 ... 2.5 (4 "f-st") mm ² ①	28 ... 12 AWG
500 V/6 kV/3 ②	300 V, 20 A $\overline{I_N}$
I_N 24 A	
Terminal block width: 5 mm / 0.197 inch	
 6 ... 7 mm / 0.24 ... 0.28 inch	

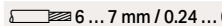
Technical Data	
0.08 ... 2.5 (4 "f-st") mm ² ①	28 ... 12 AWG
500 V/6 kV/3 ②	300 V, 20 A $\overline{I_N}$
I_N 24 A	
Terminal block width: 5 mm / 0.197 inch	
 6 ... 7 mm / 0.24 ... 0.28 inch	

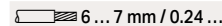
Technical Data	
0.08 ... 2.5 (4 "f-st") mm ² ①	28 ... 12 AWG
500 V/6 kV/3 ②	300 V, 20 A $\overline{I_N}$
I_N 24 A	
Terminal block width: 5 mm / 0.197 inch	
 6 ... 7 mm / 0.24 ... 0.28 inch	

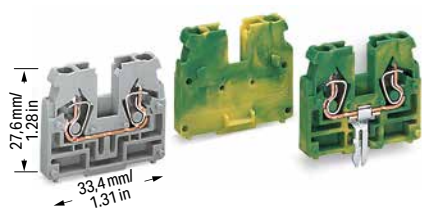

Center terminal block; without snap-in mounting foot; for 0.6 ... 1.2 mm plate thickness; required between end plate and end terminal block for terminal strips with mounting flanges

Color	Item No.	Pack. Unit
○ gray	869-321	100
● blue	869-324 ③	100
● orange	869-326	100
● green-yellow	869-327	100
○ light gray	869-329	100

End terminal block; with M3 mounting flange; for screw or similar mounting types; 3.2 mm mounting hole diameter

Color	Item No.	Pack. Unit
○ gray	869-301	100
● blue	869-304 ③	100
● green-yellow	869-307	100
○ light gray	869-309	100

End terminal block; with snap-in mounting foot; for 0.6 ... 1.2 mm plate thickness; 3.5 + 0.1 mm mounting hole diameter

Color	Item No.	Pack. Unit
○ gray	869-331	100
● blue	869-334 ③	100
● green-yellow	869-337	100
○ light gray	869-339	100

Center terminal block; with direct ground contact; 3.5 + 0.1 mm drilled hole diameter; required between end plate and end terminal block for terminal strips with mounting flanges

Notice: Terminal block cannot be commoned!

● green-yellow	869-328	100
----------------	---------	-----

End terminal block; with M4 mounting flange; for screw or similar mounting types; 4.2 mm mounting hole diameter

○ gray	869-351	100
● blue	869-354 ③	100
● green-yellow	869-357	100
○ light gray	869-359	100

End terminal block; without snap-in mounting foot; for 0.6 ... 1.2 mm plate thickness

○ gray	869-341	100
● blue	869-344 ③	100
● green-yellow	869-347	100
○ light gray	869-349	100

Accessories; item-specific

Aluminum mounting rail; 1000 mm long; 18 mm wide; 7 mm high

210-154 1



Plastic end stop; with WSB marker slot; for aluminum rail (210-154); 6 mm wide

209-122 25



Accessories; 869 Series

Appropriate marking systems: Mini-WSB/Mini-WSB Inline/WMB/WMB Inline

End plate; with M3 mounting flange; 2.5 mm thick			
	gray	869-385	100 (25)
	blue	869-388	100 (25)
	green-yellow	869-389	100 (25)
	light gray	869-387	100 (25)

Insulation stop; 0.08 ... 0.2 mm ² "s" (0.14 mm ² "f-st"); 5 pcs/strip			
	white	280-470	200 (25)

Push-in type jumper bar; insulated; I_N 18 A; light gray			
	2-way	870-402	200 (25)
	3-way	870-403	200 (25)
	4-way	870-404	100 (25)
	5-way	870-405	100 (25)
	6-way	870-406	100 (25)
	7-way	870-407	100 (25)
	8-way	870-408	100 (25)
	9-way	870-409	100 (25)
	10-way	870-410	50 (25)

End plate; with M4 mounting flange; 2.5 mm thick			
	gray	869-395	100 (25)
	blue	869-398	100 (25)
	green-yellow	869-399	100 (25)
	light gray	869-397	100 (25)

Insulation stop; 0.25 ... 0.5 mm ² ; 5 pcs/strip			
	light gray	280-471	200 (25)

End plate; for terminal blocks with snap-in mounting foot; 2.5 mm thick			
	gray	869-375	100 (25)
	blue	869-378	100 (25)
	green-yellow	869-379	100 (25)
	light gray	869-377	100 (25)

Insulation stop; 0.75 ... 1 mm ² ; 5 pcs/strip			
	dark gray	280-472	200 (25)

Test plug; with 500 mm cable; 2 mm Ø; max. 42 V			
	red	210-136	50

Protective warning marker; with black high-voltage symbol; for 5 terminal blocks			
	yellow	280-405	100 (25)

Technical Data

0.08 ... 2.5 (4 "f-st") mm ² ①	28 ... 12 AWG
500 V/6 kW/3 ②	300 V, 20 A, I_{th}
I_N 24 A	
Terminal block width: 5 mm / 0.197 inch	
 6 ... 7 mm / 0.24 ... 0.28 inch	



Center terminal block; with snap-in mounting foot; for 0.6 ... 1.2 mm plate thickness; 3.5 + 0.1 mm mounting hole diameter

Color	Item No.	Pack. Unit
○ gray	869-311	100
● blue	869-314 ③	100
● orange	869-316	100
● green-yellow	869-317	100
○ light gray	869-319	100

- ① Max. insulation diameter: 4.4 mm
 - ② 500 V = rated voltage
6 kV = rated impulse voltage
3 = pollution degree (see Section 15)
 - ③ Terminal blocks with a blue insulated housing are suitable for Ex i applications.
- See application notes for:
Insulation stop, page 382
Group marker carrier, page 471
- Approvals and corresponding ratings, visit www.wago.com

Accessories; 869 Series
Appropriate marking systems:
Mini-WSB/Mini-WSB Inline/WMB/WMB Inline

Mini-WSB Inline, plain; 1,700 WMB markers (5 mm)/reel; 5 ... 5.2 mm stretchable

	white	2009-145	1
---	-------	----------	---

Mini-WSB marking card; white; 10 strips with 10 markers/card; 5 mm wide markers

	plain	248-501	5
---	-------	---------	---

Group marker carrier; fits into the jumper slot of the current bars

	gray	870-184	50 (25)
---	------	---------	---------



Terminal strip; with M3 or M4 mounting flanges; for screw or similar mounting types
Mounting holes:
3.2 mm Ø; M3 flange
4.2 mm Ø; M4 flange



Terminal strips with snap-in mounting feet; for 0.6 ... 1.2 mm plate thickness; mounting holes: 3.5^{+0.1} mm Ø

Accessories; item-specific

Aluminum mounting rail; 1000 mm long; 18 mm wide; 7 mm high

	210-154	1
---	---------	---

Plastic end stop; with WSB marker slot; for aluminum rail (210-154); 6 mm wide

	209-122	25
---	---------	----



Inserting insulation stops into conductor entry holes of terminal strip.

The wiring of programmable logic controllers and micro-processor-operated control circuits often relies on very small, fine-stranded conductors. These conductors are highly flexible and deform when pushed against the conductor stop in terminal blocks. As a result, the conductor insulation – not the copper conductor – may be clamped, causing intermittent contact or no contact at all. Common to all terminal block types currently offered, this problem creates unnecessary downtime for troubleshooting.

The solution: an insulation stop for compact terminal blocks. Insulation stops automatically bundle the cores of fine-stranded conductors when inserted into the clamping unit, preventing splaying. This also limits the conductor entry to a defined cross sectional area – ensuring the actual conductor, not the insulation, will enter the clamping unit

The insulation stop is available as dividable 5-pole strip for the 869 Series Terminal Strips.

Insulation stop usage will not affect the conductor strip lengths for the aforementioned terminal strips.

Push-in type jumper bar; insulated; I_N 18 A; light gray

	1 to 3	870-433	200 (25)
	1 to 4	870-434	200 (25)
	1 to 5	870-435	100 (25)
	1 to 6	870-436	100 (25)
	1 to 7	870-437	100 (25)
	1 to 8	870-438	100 (25)
	1 to 9	870-439	100 (25)
	1 to 10	870-440	50 (25)

Marking strip; plain; 7.5 mm wide; 1 m long

	translucent	709-196	1
---	-------------	---------	---

Modular Terminal Blocks and Terminal Strips

264 Series

Description and Installation

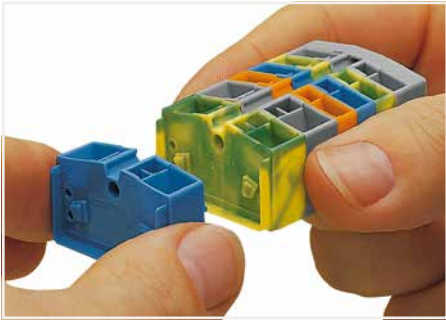

Assembling modular terminal blocks into terminal strips.

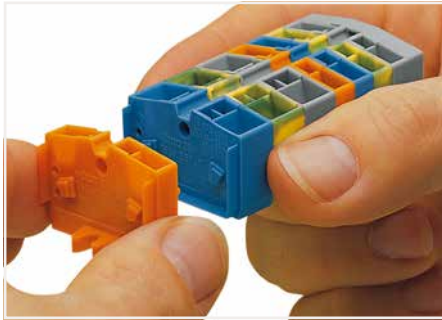

Mounting an "end terminal block" with mounting flange.

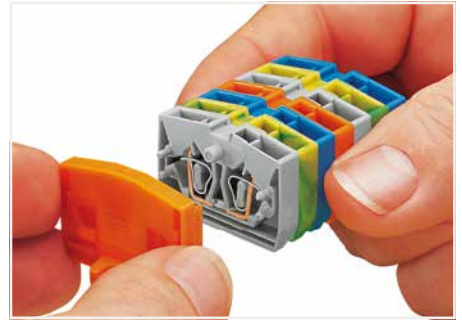

Mounting an end plate.



CAGE CLAMP® termination:
Inserting a conductor.
With ferruled conductors, it is necessary to use a terminal block one size smaller than the conductor's nominal cross section.

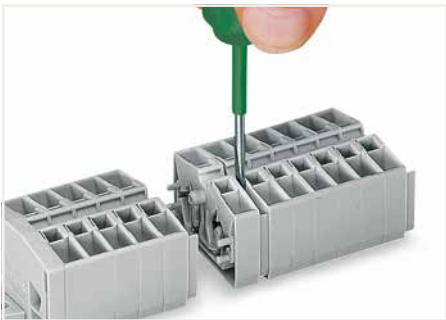

Removing a terminal block.

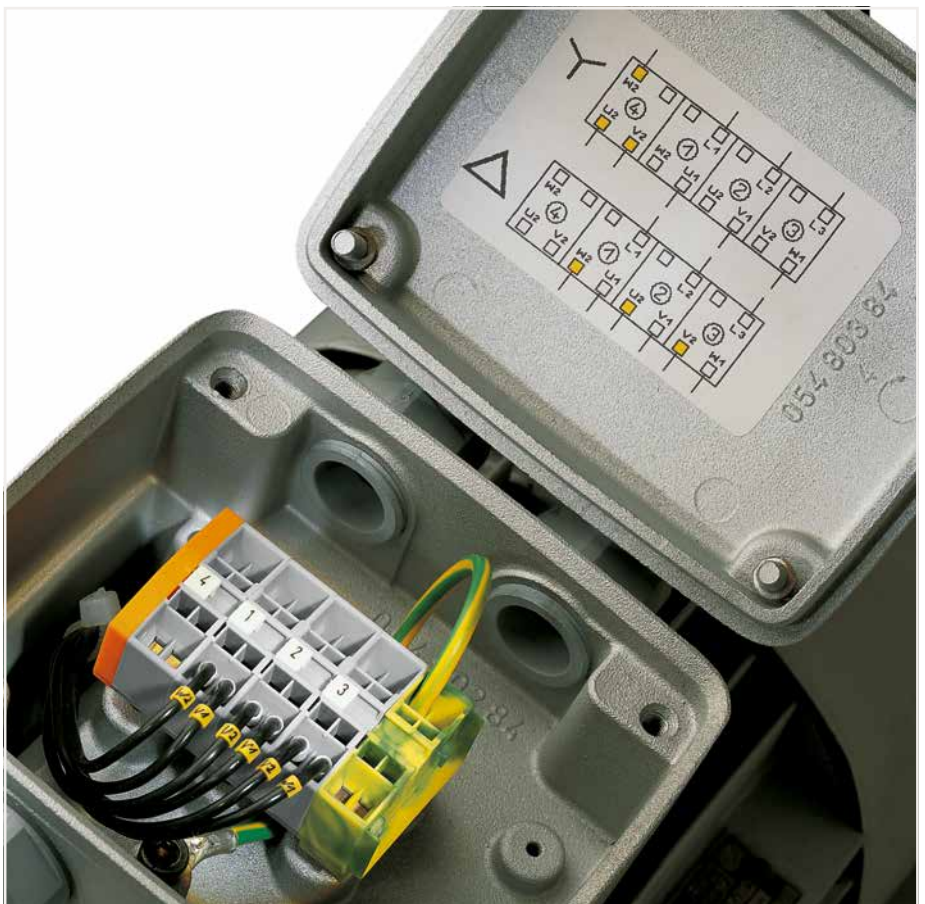

9



Commoning with comb-style jumper bar.



Marking with T-marker tag (209-290).



Combining 2- and 4-conductor terminal blocks.
Marking via Mini-WSB Quick Marking System.



CAGE CLAMP® terminates the following copper conductors:
solid "s"



stranded "st"



fine-stranded "f-st",
also with tinned
single strands



Mounting and securing a terminal strip directly to the plate via screw-type flanges.

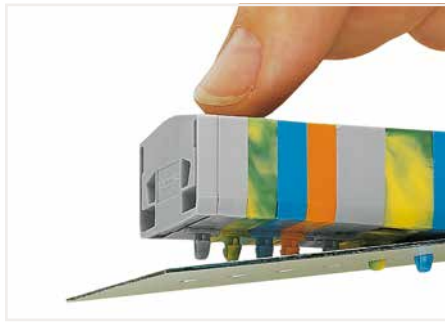

Mounting a terminal strip with snap-in feet into holes.

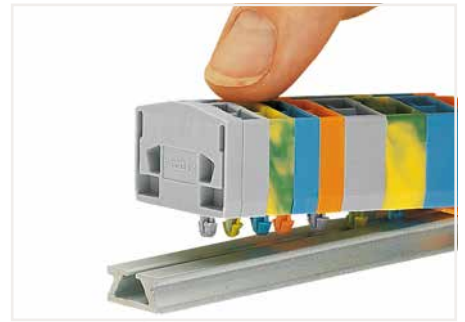

Mounting a terminal strip with snap-in feet onto the aluminum mounting rail.

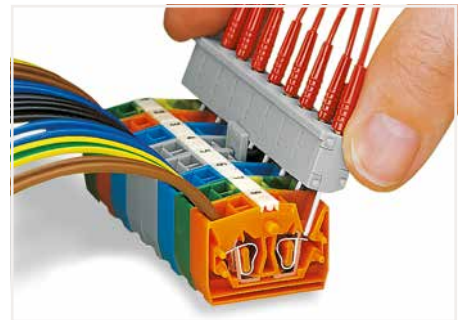
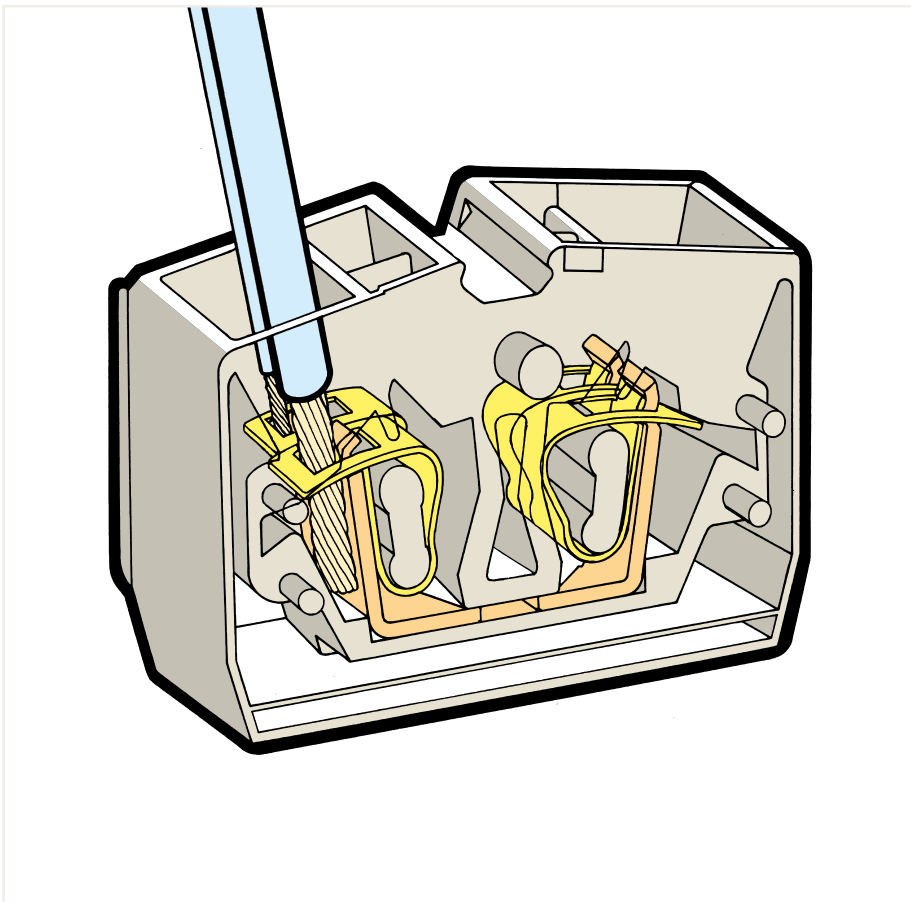

Testing by touch contact to the CAGE CLAMP® spring (limited to 0.5 A and 48 V test voltage) – test pins are not protected against accidental contact.

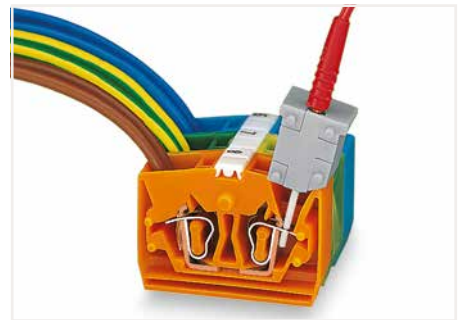

Testing via CAGE CLAMP® on the current bar (max. nominal current: 6 A). CAGE CLAMP® clamps individual test contacts. The maximum test voltage is 400 V.



Ex e II terminal strip; with mounting flanges; for screw or similar mounting types; 3.2 mm mounting hole diameter



Ex e II terminal strip; with snap-in mounting feet; for 0.6 ... 1.2 mm plate thickness; 3.5 mm mounting hole diameter



fine-stranded, tip-bonded



fine-stranded, with ferrule (gastight crimped)



fine-stranded, with pin terminal (gastight crimped)

Modular Terminal Block; with Mounting Flange

2.5 mm²; 264 Series

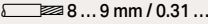
Technical Data	
0.08 ... 2.5 mm ²	28 ... 12 AWG*
800 V/8 kV/3 ①	300 V, 20 A ②
I _N 24 A	600 V, 20 A ③
Terminal block width: 6 mm / 0.236 inch	
 8 ... 9 mm / 0.31 ... 0.35 inch	

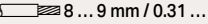
Technical Data	
0.08 ... 2.5 mm ²	28 ... 12 AWG*
800 V/8 kV/3 ①	300 V, 20 A ②
I _N 24 A	600 V, 20 A ③
Terminal block width: 10 mm / 0.394 inch	
 8 ... 9 mm / 0.31 ... 0.35 inch	



*12 AWG: THHN, THWN

- ① 800 V = rated voltage
8 kV = rated impulse voltage
3 = pollution degree
(see Section 15)
- ② Terminal blocks with a blue insulated housing are suitable for Ex i applications.
- ③ Terminal blocks with an Ex mark are suitable for Ex e II applications.
0.5 ... 2.5 mm² / 20 ... 12 AWG*
690 V; 23 A
(see Section 15)

See application notes for:
Alternate comb-style jumper bar, page 383
Test plug module, page 510
Mini-WSB marking system, page 641

Approvals and corresponding ratings, visit www.wago.com

2-conductor center terminal block; required between end plate and end terminal block for terminal strips with mounting flanges

Color	Item No.	Pack. Unit
gray	264-321	100
blue	264-324 ②	100
orange	264-326	100
green-yellow	264-327	100
light gray ③	264-131 ③	100

4-conductor center terminal block; required between end plate and end terminal block for terminal strips with mounting flanges

Color	Item No.	Pack. Unit
gray	264-351	100
blue	264-354 ②	100
orange	264-356	100
green-yellow	264-357	100
light gray ③	264-231 ③	100

2-conductor end terminal block; with mounting flange; for screw or similar mounting types; 3.2 mm mounting hole diameter

Color	Item No.	Pack. Unit
gray	264-301	100
blue	264-304 ②	100
orange	264-306	100
green-yellow	264-307	100
light gray ③	264-130 ③	100

4-conductor end terminal block; with mounting flange; for screw or similar mounting types; 3.2 mm mounting hole diameter

Color	Item No.	Pack. Unit
gray	264-331	100
blue	264-334 ②	100
orange	264-336	100
green-yellow	264-337	100
light gray ③	264-230 ③	100

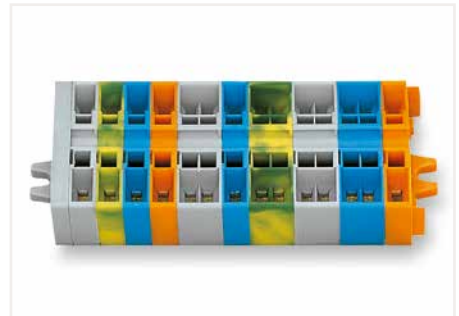

- Terminal strip with mounting flanges, consisting of:
- End plate; with mounting flange
 - Center terminal blocks
 - End terminal block; with mounting flange

9

Accessories; item-specific

Alternate comb-style jumper bar; insulated; I_N = I_N of terminal block

	2-way	281-492	100 (25)
---	-------	---------	----------

Accessories; item-specific

Alternate comb-style jumper bar; insulated; I_N = I_N of terminal block

	2-way	280-492	200 (25)
---	-------	---------	----------

Test plug module; snaps together; 6 mm wide

	gray	249-136	100 (25)
---	------	---------	----------

Test plug module; snaps together; 10 mm wide

	gray	249-139	100 (25)
---	------	---------	----------

Mini-WSB marking card; white; 10 strips with 10 markers/ card; 5 mm wide markers

	plain	248-501	5
--	-------	---------	---

Mini-WSB marking card; white; 10 strips with 10 markers/ card; 5 mm wide markers

		264-900	5
---	--	---------	---

Accessories; 264 Series

Appropriate marking systems: Mini-WSB/Mini-WSB Inline/T-marker tag

End and intermediate plate; 4 mm thick

	gray	264-361	25
	orange	264-364	25
	light gray	264-363	25

Test plug; with 500 mm cable; 2 mm Ø; max. 42 V

	red	210-136	50
---	-----	---------	----

Comb-style jumper bar; insulated; reduces maximum conductor size to 1.5 mm²; I_N 16 A; gray

	2-way	264-402	200 (25)
---	-------	---------	----------

T-marker tag; 30 markers per tag; up to 6 characters per marker; stretchable 5 ... 6 mm

	plain	209-290	50
---	-------	---------	----

Operating tool; insulated

	2-way	280-432	1
---	-------	---------	---

Mini-WSB marking card; white; 10 strips with 10 markers/ card; 5 mm wide markers

	plain	248-501	5
---	-------	---------	---

Modular Terminal Block; with Snap-In Mounting Foot 2.5 mm²; 264 Series

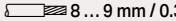
Technical Data	
0.08 ... 2.5 mm ²	28 ... 12 AWG*
800 V/8 kV/3 ①	300 V, 20 A ②
I _N 24 A	600 V, 20 A ③
Terminal block width: 6 mm / 0.236 inch	
 8 ... 9 mm / 0.31 ... 0.35 inch	



Technical Data	
0.08 ... 2.5 mm ²	28 ... 12 AWG*
800 V/8 kV/3 ①	300 V, 20 A ②
I _N 24 A	600 V, 20 A ③
Terminal block width: 10 mm / 0.394 inch	
 8 ... 9 mm / 0.31 ... 0.35 inch	





*12 AWG: THHN, THWN

- 800 V = rated voltage
8 kV = rated impulse voltage
3 = pollution degree
(see Section 15)
- Terminal blocks with a blue insulated housing are suitable for Ex i applications.
- Terminal blocks with an Ex mark are suitable for Ex e II applications.
0.5 ... 2.5 mm² / 20 ... 12 AWG*
690 V; 23 A
(see Section 15)



See application notes for:
Alternate comb-style jumper bar, page 383
Test plug module, page 510
Mini-WSB marking system, page 641

Approvals and corresponding ratings,
visit www.wago.com

2-conductor terminal block; with snap-in mounting foot; for 0.6 ... 1.2 mm plate thickness; 3.5 mm mounting hole diameter

Color	Item No.	Pack. Unit
 gray	264-311	100
 blue	264-314 ②	100
 orange	264-316	100
 green-yellow	264-317	100
 light gray ③	264-180 ④	100

4-conductor terminal block; with snap-in mounting foot; for 0.6 ... 1.2 mm plate thickness; 3.5 mm mounting hole diameter

Color	Item No.	Pack. Unit
 gray	264-341	100
 blue	264-344 ②	100
 orange	264-346	100
 green-yellow	264-347	100
 light gray ③	264-280 ④	100

Accessories; item-specific

Alternate comb-style jumper bar; insulated; I_N = I_N of terminal block

	2-way	281-492	100 (25)
---	-------	---------	----------

Test plug module; snaps together; 6 mm wide

	gray	249-136	100 (25)
---	------	---------	----------

Mini-WSB marking card; white; 10 strips with 10 markers/card; 5 mm wide markers

	plain	248-501	5
---	-------	---------	---

Accessories; item-specific

Alternate comb-style jumper bar; insulated; I_N = I_N of terminal block

	2-way	280-492	200 (25)
---	-------	---------	----------

Test plug module; snaps together; 10 mm wide

	gray	249-139	100 (25)
---	------	---------	----------

Mini-WSB marking card; white; 10 strips with 10 markers/card; 5 mm wide markers

		264-900	5
---	--	---------	---



Terminal strip with mounting flanges, consisting of:
End plate

- 4-conductor terminal strip; with snap-in mounting foot 1)
 - Center terminal blocks
 - 2-conductor terminal strip; with snap-in mounting foot 1)
- 1) at every 4th or 5th terminal block of the strip

Accessories; 264 Series

Appropriate marking systems: Mini-WSB/Mini-WSB Inline/T-marker tag

End and intermediate plate; 4 mm thick

	gray	264-371	25
	orange	264-374	25
	light gray	264-373	25

Comb-style jumper bar; insulated; reduces maximum conductor size to 1.5 mm²; I_N 16 A; gray

	2-way	264-402	200 (25)
---	-------	---------	----------

Operating tool; insulated

	2-way	280-432	1
---	-------	---------	---

Test plug; with 500 mm cable; 2 mm Ø; max. 42 V

	red	210-136	50
---	-----	---------	----

Aluminum mounting rail; 1000 mm long; 18 mm wide; 7 mm high

		210-154	1
---	--	---------	---

Plastic end stop; with WSB marker slot; for aluminum mounting rail (210-154); 6 mm wide

		209-122	25
---	--	---------	----

T-marker tag; 30 markers per tag; up to 6 characters per marker; stretchable 5 ... 6 mm

	plain	209-290	50
---	-------	---------	----

Mini-WSB Inline, plain; 1,700 WMB markers (5 mm)/reel; 5 ... 5.2 mm stretchable

	white	2009-145	1
---	-------	----------	---

Mini-WSB marking card; white; 10 strips with 10 markers/card; 5 mm wide markers

	plain	248-501	5
---	-------	---------	---

Operating tool with a partially insulated shaft; Type 2; (3.5 x 0.5) mm blade

		210-720	1
---	--	---------	---

Terminal Strip; with Mounting Flanges or Snap-in Mounting Feet 2.5 mm²; 264 Series

Technical Data	
0.08 ... 2.5 mm ²	28 ... 12 AWG*
800 V/8 kV/3 ①	300 V, 20 A ②
I _N 24 A	600 V, 20 A ③
Pole width: 6 mm / 0.236 inch	
8 ... 9 mm / 0.31 ... 0.35 inch	

Technical Data	
0.08 ... 2.5 mm ²	28 ... 12 AWG*
800 V/8 kV/3 ①	300 V, 20 A ②
I _N 24 A	600 V, 20 A ③
Pole width: 10 mm / 0.394 inch	
8 ... 9 mm / 0.31 ... 0.35 inch	

Technical Data	
0.08 ... 2.5 mm ²	28 ... 12 AWG*
690 V ②	300 V, 20 A ③
I _N 23 A	600 V, 20 A ④
Pole width: 6 mm / 0.236 inch	
8 ... 9 mm / 0.31 ... 0.35 inch	



Dimensions in mm

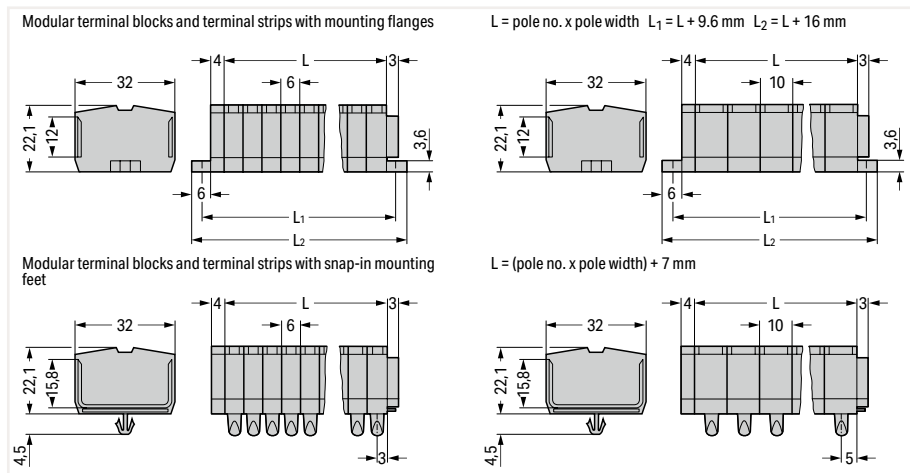

2-conductor terminal strip; with mounting flanges; for screw or similar mounting types; 3.2 mm mounting hole diameter; gray

Pole No.	Item No.	Pack. Unit
2	264-102	100
3	264-103	100
4	264-104	100
5	264-105	100
6	264-106	100
7	264-107	100
8	264-108	100
9	264-109	50
10	264-110	50
11	264-111	50
12 ③	264-112	25

4-conductor terminal strip; with mounting flanges; for screw or similar mounting types; 3.2 mm mounting hole diameter; gray

Pole No.	Item No.	Pack. Unit
2	264-202	100
3	264-203	100
4	264-204	100
5	264-205	100
6	264-206	100
7	264-207	100
8	264-208	100
9	264-209	50
10	264-210	50
11	264-211	25
12 ③	264-212	25

2-conductor Ex e II terminal strip; with mounting flanges; for screw or similar mounting types; 3.2 mm mounting hole diameter; light gray

Pole No.	Item No.	Pack. Unit
2 ④	264-132	100
3 ④	264-133	100
4 ④	264-134	100
5 ④	264-135	100
6 ④	264-136	100
7 ④	264-137	100
8 ④	264-138	100
9 ④	264-139	50
10 ④	264-140	50
11 ④	264-141	25
12 ④ ③	264-142	25

2-conductor terminal strip; with snap-in mounting feet; for 0.6 ... 1.2 mm plate thickness; 3.5 mm mounting hole diameter; gray

Pole No.	Item No.	Pack. Unit
2	264-152	100
3	264-153	100
4	264-154	100
5	264-155	100
6	264-156	50
7	264-157	50
8	264-158	50
9	264-159	50
10	264-160	25
11	264-161	25
12 ③	264-162	25

4-conductor terminal strip; with snap-in mounting feet; for 0.6 ... 1.2 mm plate thickness; 3.5 mm mounting hole diameter; gray

Pole No.	Item No.	Pack. Unit
2	264-252	100
3	264-253	100
4	264-254	100
5	264-255	100
6	264-256	50
7	264-257	50
8	264-258	50
9	264-259	50
10	264-260	25
11	264-261	25
12 ③	264-262	25

2-conductor Ex e II terminal strip; with snap-in mounting feet; for 0.6 ... 1.2 mm plate thickness; 3.5 mm mounting hole diameter; light gray

Pole No.	Item No.	Pack. Unit
2 ④	264-182	100
3 ④	264-183	100
4 ④	264-184	100
5 ④	264-185	100
6 ④	264-186	50
7 ④	264-187	50
8 ④	264-188	50
9 ④	264-189	50
10 ④	264-190	25
11 ④	264-191	25
12 ④ ③	264-192	25

Technical Data

0.08 ... 2.5 mm ²	28 ... 12 AWG*
690 V ②	300 V, 20 A ④
I _N 23 A	600 V, 20 A ④
Pole width: 10 mm / 0.394 inch	
8 ... 9 mm / 0.31 ... 0.35 inch	



*12 AWG: THHN, THWN

- ① 800 V = rated voltage
8 kV = rated impulse voltage
3 = pollution degree
(see Section 15)
- ② Suitable for Ex e II applications
(see Section 15)
- ③ Longer strips and/or mixed-color assemblies are available upon request.

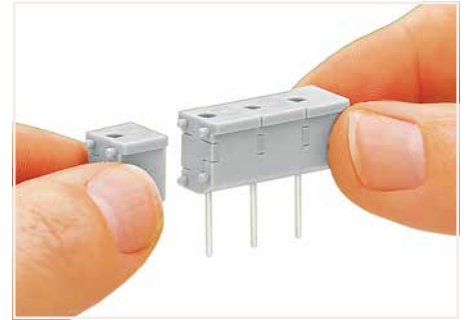
Approvals and corresponding ratings, visit www.wago.com

Snapping individual modules together to assemble a multi-pole test plug module.



Item no. suffixes for gray terminal strips with mounting flanges:

264-102 to 264-112
264-202 to 264-212blue .../000-006,
Terminal strips with a blue insulated housing are suitable for Ex i applications.

Item no. suffixes for gray terminal strips with snap-in mounting feet:

264-152 to 264-162
264-252 to 264-262blue .../000-006,
Terminal strips with a blue insulated housing are suitable for Ex i applications.

4-conductor Ex e II terminal strip; with mounting flanges; for screw or similar mounting types; 3.2 mm mounting hole diameter; light gray

Pole No.	Item No.	Pack. Unit
○ 2 ④	264-232	100
○ 3 ④	264-233	100
○ 4 ④	264-234	100
○ 5 ④	264-235	100
○ 6 ④	264-236	100
○ 7 ④	264-237	100
○ 8 ④	264-238	100
○ 9 ④	264-239	50
○ 10 ④	264-240	50
○ 11 ④	264-241	100
○ 12 ④ ③	264-242	25



Ex e II terminal strip; with mounting flanges; for screw or similar mounting types; 3.2 mm mounting hole diameter



Ex e II terminal strip; with snap-in mounting feet; for 0.6 ... 1.2 mm plate thickness; 3.5 mm mounting hole diameter

4-conductor Ex e II terminal strip; with snap-in mounting feet; for 0.6 ... 1.2 mm plate thickness; 3.5 mm mounting hole diameter; light gray

○ 2 ④	264-282	100
○ 3 ④	264-283	100
○ 4 ④	264-284	100
○ 5 ④	264-285	100
○ 6 ④	264-286	100
○ 7 ④	264-287	50
○ 8 ④	264-288	50
○ 9 ④	264-289	50
○ 10 ④	264-290	25
○ 11 ④	264-291	25
○ 12 ④ ③	264-292	25

Modular Terminal Blocks and Terminal Strips

260 to 262 Series

Description and Installation

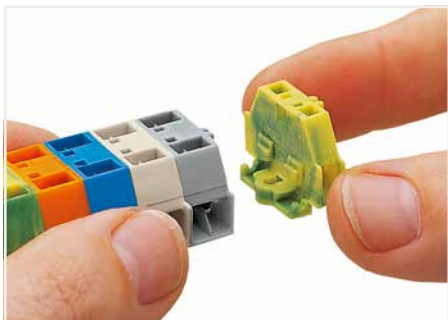

Assembling modular terminal blocks into terminal strips.



Mounting an end plate.

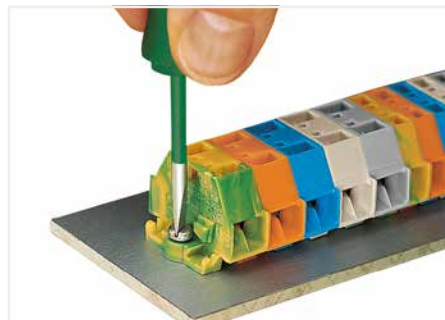

Mounting and securing a terminal strip directly to the plate via screw-type flanges.



CAGE CLAMP® termination:
Inserting a conductor.
With ferruled conductors, it is necessary to use a terminal block one size smaller than the conductor's nominal cross section.

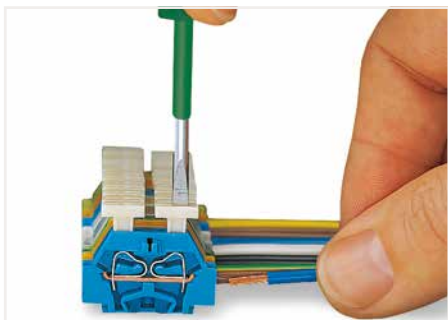

CAGE CLAMP® termination:
Inserting a conductor via push-button.

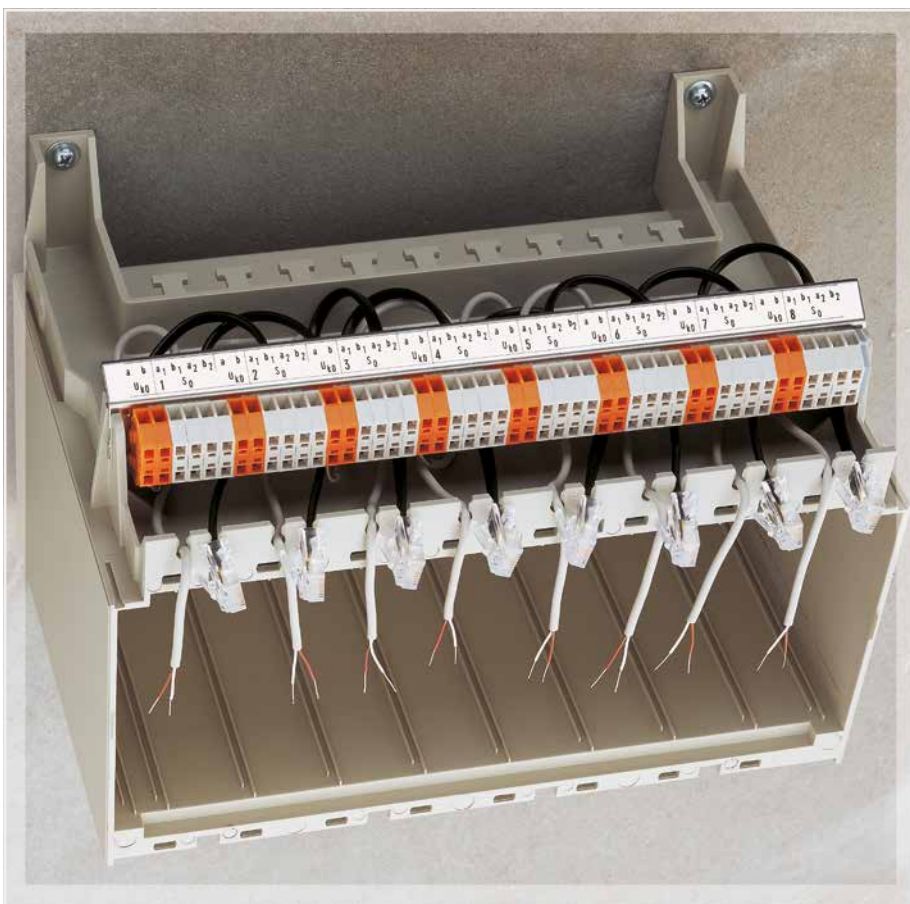

9

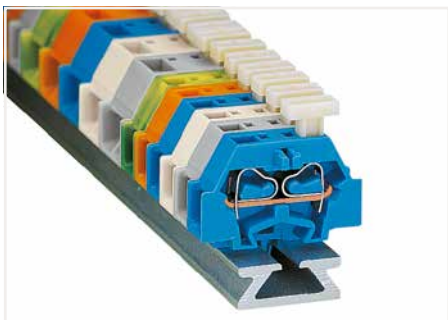

Terminal strip; with push-buttons on one side

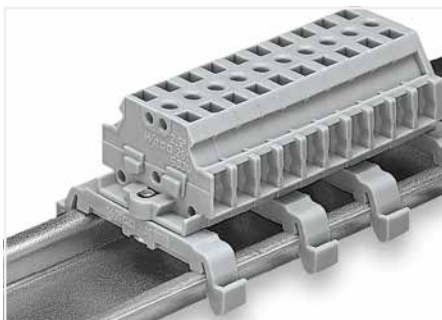

Terminal strip; with marker slot for Mini-WSB Quick Marking System



Commoning with comb-style jumper bar.



CAGE CLAMP® terminates the following copper conductors: solid "s"



stranded "st"



fine-stranded "f-st", also with tinned single strands



Mounting a terminal strip with snap-in feet into holes.

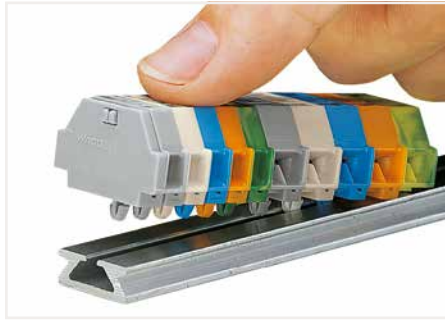

Mounting a terminal strip with snap-in feet onto the aluminum rail.



Mounting and securing a terminal strip directly to the plate via screw-type flanges. screwing a mounting foot (209-123) (distance between mounting feet: approx. 20 ... 25 mm)

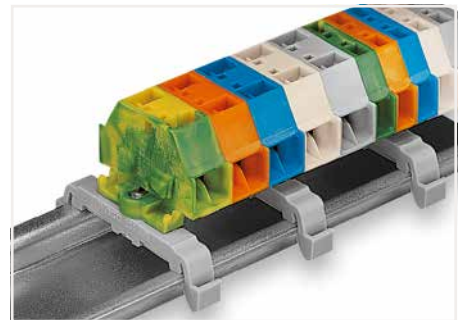
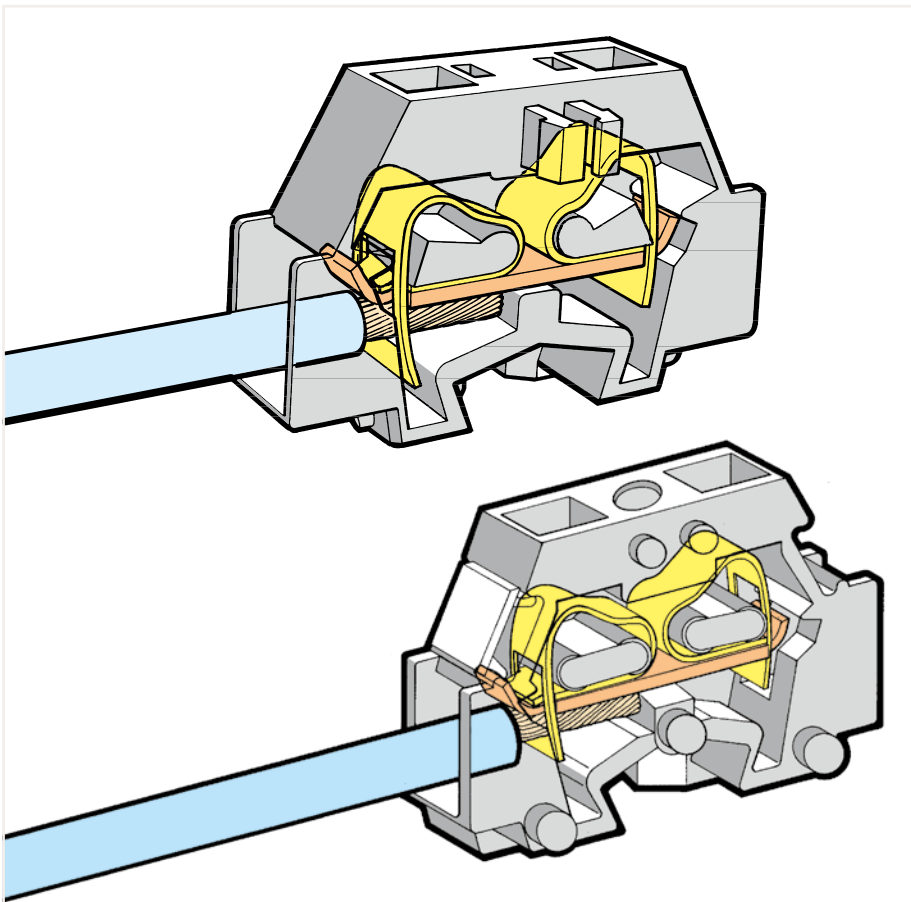

Terminal strip; with mounting flanges; for DIN-35 rail

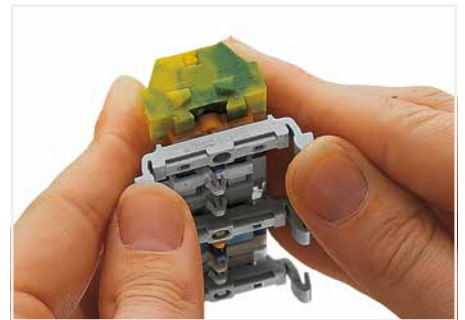

Terminal strip; with snap-in mounting feet; snapping a mounting foot (209-120) (distance between mounting feet: approx. 20 ... 25 mm)

9



Marking with self-adhesive marking strips.



Marking by direct printing (upon request).

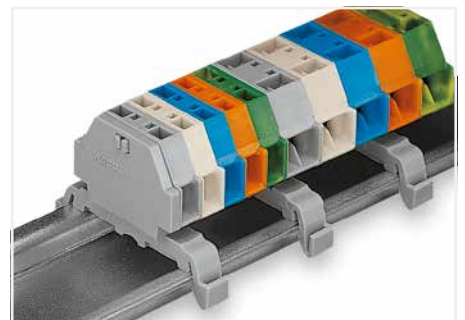

Terminal strip; with snap-in mounting feet; for DIN-35 rail



fine-stranded, tip-bonded



fine-stranded, with ferrule (gastight crimped)



fine-stranded, with pin terminal (gastight crimped)

Modular Terminal Block; with Mounting Flange or Snap-In Mounting Foot 1.5 mm²; 260 Series

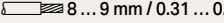
Technical Data	
0.08 ... 1.5 mm ² (28 ... 16 AWG)	28 ... 16 AWG
400 V/6 kV/3 ①	300 V, 10 A ②
I _N 18 A	300 V, 15 A ③
Terminal block width: 5 mm / 0.197 inch	
 8 ... 9 mm / 0.31 ... 0.35 inch	

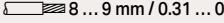
Technical Data	
0.08 ... 1.5 mm ² (28 ... 16 AWG)	28 ... 16 AWG
400 V/6 kV/3 ①	300 V, 10 A ②
I _N 18 A	300 V, 15 A ③
Terminal block width: 8 mm / 0.315 inch	
 8 ... 9 mm / 0.31 ... 0.35 inch	



2-conductor terminal block; with mounting flange; for screw or similar mounting types; 3.2 mm mounting hole diameter; with mounting foot (209-123) also for DIN-35 rail

Color	Item No.	Pack. Unit
gray	260-301	300 (50)
light gray	260-303	300 (50)
blue	260-304	300 (50)
orange	260-306	300 (50)
green-yellow	260-307	300 (50)

4-conductor terminal block; with mounting flange; for screw or similar mounting types; 3.2 mm mounting hole diameter; with mounting foot (209-123) also for DIN-35 rail

Color	Item No.	Pack. Unit
gray	260-331	300 (50)
light gray	260-333	300 (50)
blue	260-334	300 (50)
orange	260-336	300 (50)
green-yellow	260-337	300 (50)

2-conductor terminal block; with snap-in mounting foot; for 0.6 ... 1.2 mm plate thickness; 3.5 mm mounting hole diameter; also for aluminum rail (210-154) or with mounting foot (209-120) for DIN-35 rail

Color	Item No.	Pack. Unit
gray	260-311	300 (50)
light gray	260-313	300 (50)
blue	260-314	300 (50)
orange	260-316	300 (50)
green-yellow	260-317	300 (50)

4-conductor terminal block; with snap-in mounting foot; for 0.6 ... 1.2 mm plate thickness; 3.5 mm mounting hole diameter; also for aluminum rail (210-154) or with mounting foot (209-120) for DIN-35 rail

Color	Item No.	Pack. Unit
gray	260-341	300 (50)
light gray	260-343	300 (50)
blue	260-344	300 (50)
orange	260-346	300 (50)
green-yellow	260-347	300 (50)

Space-saving 2-conductor end terminal block; without protruding snap-in mounting foot; for terminal strips with snap-in mounting feet

Color	Item No.	Pack. Unit
gray	260-321	300 (50)
light gray	260-323	300 (50)
blue	260-324	300 (50)
orange	260-326	300 (50)
green-yellow	260-327	300 (50)

Space-saving 4-conductor end terminal block; without protruding snap-in mounting foot; for terminal strips with snap-in mounting feet

Color	Item No.	Pack. Unit
gray	260-351	300 (50)
light gray	260-353	300 (50)
blue	260-354	300 (50)
orange	260-356	300 (50)
green-yellow	260-357	300 (50)

Accessories; item-specific
Test plug module; snaps together; 5 mm wide

Color	Item No.	Pack. Unit
gray	249-135	100 (25)

Accessories; item-specific
Test plug module; snaps together; 8 mm wide

Color	Item No.	Pack. Unit
gray	249-138	100 (25)

Test plug module; with locking latches; snaps together; 5 mm wide

Color	Item No.	Pack. Unit
gray	260-404	100 (25)

Test plug module; with locking latches; snaps together; 8 mm wide

Color	Item No.	Pack. Unit
gray	260-405	100 (25)

Accessories; 260 Series
Marking accessories, see Section 14

End plate; with mounting flange

Color	Item No.	Pack. Unit
gray	260-361	300 (50)

Comb-style jumper bar; insulated; reduces maximum conductor size to 1 mm²; I_N 10 A; gray

Color	Item No.	Pack. Unit
gray	260-402	25

End plate; with snap-in mounting foot

Color	Item No.	Pack. Unit
gray	260-371	300 (50)

Operating tool; insulated; for comb-style jumper bar

Color	Item No.	Pack. Unit
gray	209-132	1

① 400 V = rated voltage
6 kV = rated impulse voltage
3 = pollution degree
(see Section 15)

See application notes for:
Test plug module, page 510

Approvals and corresponding ratings,
visit www.wago.com

Accessories; 260 Series
Marking accessories, see Section 14

Test plug; with 500 mm cable; 2 mm Ø; max. 42 V

Color	Item No.	Pack. Unit
red	210-136	50

Aluminum mounting rail; 1000 mm long; 18 mm wide; 7 mm high

Color	Item No.	Pack. Unit
gray	210-154	1

Plastic end stop; with WSB marker slot; for aluminum rail (210-154); 6 mm wide

Color	Item No.	Pack. Unit
gray	209-122	25

Mounting foot; for DIN-35 rail; snaps onto terminal blocks with snap-in mounting foot; 6.4 mm wide

Color	Item No.	Pack. Unit
gray	209-120	25

Mounting screw; for mounting foot (209-120)

Color	Item No.	Pack. Unit
gray	209-119	500 (50)

Mounting foot with screw; for DIN-35 rail; can be screwed on terminal blocks with mounting flange; 6.4 mm wide

Color	Item No.	Pack. Unit
gray	209-123	25

Mounting adapter; for DIN-35 rail; can be used as end plate; 6.5 mm wide

Color	Item No.	Pack. Unit
gray	209-137	25

Operating tool with a partially insulated shaft; Type 2; (3.5 x 0.5) mm blade

Color	Item No.	Pack. Unit
gray	210-720	1

9

Terminal Strip; with Mounting Flanges or Snap-in Mounting Feet 1.5 mm²; 260 Series

Technical Data	
0.08 ... 1.5 mm ² (28 ... 16 AWG)	28 ... 16 AWG
400 V/6 kV/3 ①	300 V, 10 A ②
I _N 18 A	300 V, 15 A ③
Pole width: 5 mm / 0.197 inch	
8 ... 9 mm / 0.31 ... 0.35 inch	

Technical Data	
0.08 ... 1.5 mm ² (28 ... 16 AWG)	28 ... 16 AWG
400 V/6 kV/3 ①	300 V, 10 A ②
I _N 18 A	300 V, 15 A ③
Pole width: 8 mm / 0.315 inch	
8 ... 9 mm / 0.31 ... 0.35 inch	

- ① 400 V = rated voltage
6 kV = rated impulse voltage
3 = pollution degree
(see Section 15)
 - ② Longer strips and/or mixed-color assemblies are available upon request.
- Approvals and corresponding ratings, visit www.wago.com

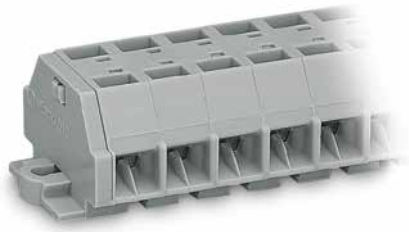
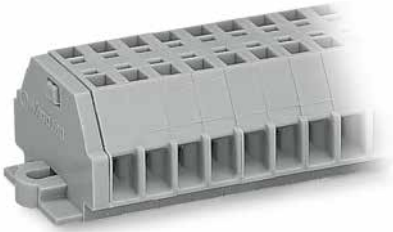

Dimensions in mm

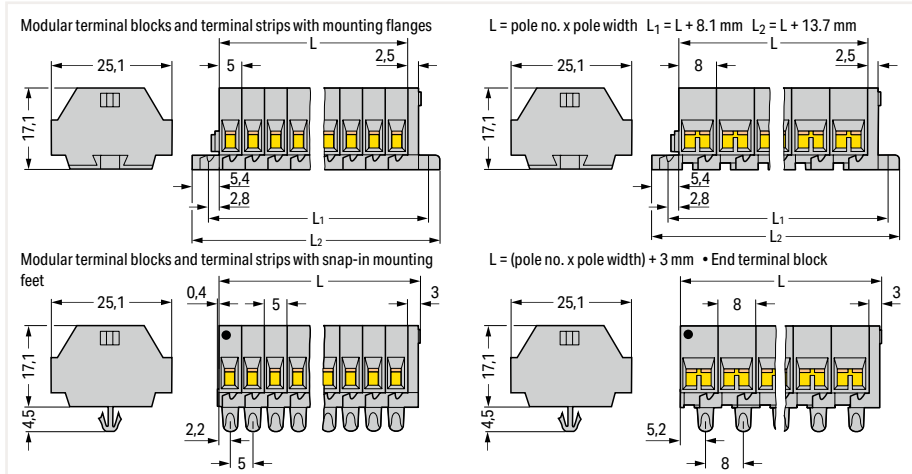

Terminal strip; with mounting flanges; for screw or similar mounting types; 3.2 mm mounting hole diameter (with 209-123 Mounting Foot for DIN-35 rail)

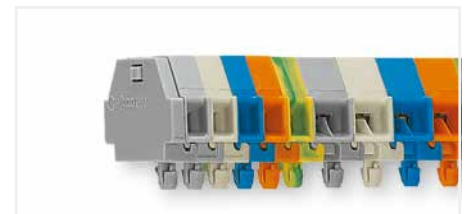

Terminal strip; with snap-in mounting feet; for 0.6 ... 1.2 mm plate thickness; 3.5 mm mounting hole diameter (also for 210-154 Aluminum Rail or with 209-120 Mounting Foot for DIN-35 rail)

2-conductor terminal strip; with mounting flanges; for screw or similar mounting types; 3.2 mm mounting hole diameter; with mounting foot (209-123) also for DIN-35 rail; gray

Pole No.	Item No.	Pack. Unit
○ 2	260-102	100
○ 3	260-103	100
○ 4	260-104	100
○ 5	260-105	100
○ 6	260-106	100
○ 7	260-107	100
○ 8	260-108	100
○ 9	260-109	50
○ 10	260-110	50
○ 11	260-111	50
○ 12 ②	260-112	25

4-conductor terminal strip; with mounting flanges; for screw or similar mounting types; 3.2 mm mounting hole diameter; with mounting foot (209-123) also for DIN-35 rail; gray

Pole No.	Item No.	Pack. Unit
○ 2	260-202	100
○ 3	260-203	100
○ 4	260-204	100
○ 5	260-205	100
○ 6	260-206	100
○ 7	260-207	100
○ 8	260-208	100
○ 9	260-209	50
○ 10	260-210	50
○ 11	260-211	25
○ 12 ②	260-212	25

2-conductor terminal strip; with snap-in mounting feet; for 0.6 ... 1.2 mm plate thickness; 3.5 mm mounting hole diameter; also for aluminum rail (210-154) or with mounting foot (209-120) for DIN-35 rail; gray

Pole No.	Item No.	Pack. Unit
○ 2	260-152	100
○ 3	260-153	100
○ 4	260-154	100
○ 5	260-155	100
○ 6	260-156	50
○ 7	260-157	50
○ 8	260-158	50
○ 9	260-159	50
○ 10	260-160	25
○ 11	260-161	25
○ 12 ②	260-162	25

4-conductor terminal strip; with snap-in mounting feet; for 0.6 ... 1.2 mm plate thickness; 3.5 mm mounting hole diameter; also for aluminum rail (210-154) or with mounting foot (209-120) for DIN-35 rail; gray

Pole No.	Item No.	Pack. Unit
○ 2	260-252	100
○ 3	260-253	100
○ 4	260-254	100
○ 5	260-255	100
○ 6	260-256	50
○ 7	260-257	50
○ 8	260-258	50
○ 9	260-259	50
○ 10	260-260	25
○ 11	260-261	25
○ 12 ②	260-262	25

Modular Terminal Block; with Mounting Flange or Snap-In Mounting Foot 2.5 mm²; 261 Series

Technical Data

0.08 ... 2.5 mm ²	28 ... 14 AWG
500 V/6 kV/3 ①	300 V, 15 A
I _N 24 A	300 V, 20 A
Terminal block width: 6 mm / 0.236 inch	
8 ... 9 mm / 0.31 ... 0.35 inch	

Technical Data

0.08 ... 2.5 mm ²	28 ... 14 AWG
500 V/6 kV/3 ①	300 V, 15 A
I _N 24 A	300 V, 20 A
Terminal block width: 10 mm / 0.394 inch	
8 ... 9 mm / 0.31 ... 0.35 inch	



2-conductor terminal block; with mounting flange; for screw or similar mounting types; 3.2 mm mounting hole diameter; with mounting foot (209-123) also for DIN-35 rail

Color	Item No.	Pack. Unit
gray	261-301	200 (50)
light gray	261-303	200 (50)
blue	261-304 ②	200 (50)
orange	261-306	200 (50)
green-yellow	261-307	200 (50)

4-conductor terminal block; with mounting flange; for screw or similar mounting types; 3.2 mm mounting hole diameter; with mounting foot (209-123) also for DIN-35 rail

Color	Item No.	Pack. Unit
gray	261-331	200 (50)
light gray	261-333	200 (50)
blue	261-334 ②	200 (50)
orange	261-336	200 (50)
green-yellow	261-337	200 (50)

2-conductor terminal block; with snap-in mounting foot; for 0.6 ... 1.2 mm plate thickness; 3.5 mm mounting hole diameter; also for aluminum rail (210-154) or with mounting foot (209-120) for DIN-35 rail

Color	Item No.	Pack. Unit
gray	261-311	200 (50)
light gray	261-313	200 (50)
blue	261-314 ②	200 (50)
orange	261-316	200 (50)
green-yellow	261-317	200 (50)

4-conductor terminal block; with snap-in mounting foot; for 0.6 ... 1.2 mm plate thickness; 3.5 mm mounting hole diameter; also for aluminum rail (210-154) or with mounting foot (209-120) for DIN-35 rail

Color	Item No.	Pack. Unit
gray	261-341	200 (50)
light gray	261-343	200 (50)
blue	261-344 ②	200 (50)
orange	261-346	200 (50)
green-yellow	261-347	200 (50)

Space-saving 2-conductor end terminal block; without protruding snap-in mounting foot; for terminal strips with snap-in mounting feet

Color	Item No.	Pack. Unit
gray	261-321	200 (50)
light gray	261-323	200 (50)
blue	261-324 ②	200 (50)
orange	261-326	200 (50)
green-yellow	261-327	200 (50)

Space-saving 4-conductor end terminal block; without protruding snap-in mounting foot; for terminal strips with snap-in mounting feet

Color	Item No.	Pack. Unit
gray	261-351	200 (50)
light gray	261-353	200 (50)
blue	261-354 ②	200 (50)
orange	261-356	200 (50)
green-yellow	261-357	200 (50)

Accessories; item-specific

Test plug module; snaps together; 6 mm wide

	gray	249-136	100 (25)
--	------	---------	----------

Test plug module; with locking latches; snaps together; 6 mm wide

	gray	261-404	100 (25)
--	------	---------	----------

Accessories; item-specific

Test plug module; snaps together; 10 mm wide

	gray	249-139	100 (25)
--	------	---------	----------

Test plug module; with locking latches; snaps together; 10 mm wide

	gray	261-405	100 (25)
--	------	---------	----------

Accessories; 261 Series

Marking accessories, see Section 14

End plate; with mounting flange

	gray	261-361	300 (50)
--	------	---------	----------

End plate; with snap-in mounting foot

	gray	261-371	300 (50)
--	------	---------	----------

Comb-style jumper bar; insulated; reduces maximum conductor size to 1.5 mm²; I_N 16 A; gray

	2-way	261-402	25
--	-------	---------	----

Operating tool; insulated; for comb-style jumper bar

	2-way	209-132	1
--	-------	---------	---

① 500 V = rated voltage
6 kV = rated impulse voltage
3 = pollution degree
(see Section 15)

② Terminal blocks with a blue insulated housing are suitable for Ex i applications.

See application notes for:
Test plug module, page 510

Approvals and corresponding ratings,
visit www.wago.com

Accessories; 261 Series

Marking accessories, see Section 14

Test plug; with 500 mm cable; 2 mm Ø; max. 42 V

	red	210-136	50
--	-----	---------	----

Aluminum mounting rail; 1000 mm long; 18 mm wide; 7 mm high

		210-154	1
--	--	---------	---

Plastic end stop; with WSB marker slot; for aluminum rail (210-154); 6 mm wide

		209-122	25
--	--	---------	----

Mounting foot; for DIN-35 rail; snaps onto terminal blocks with snap-in mounting foot; 6.4 mm wide

	gray	209-120	25
--	------	---------	----

Mounting screw; for mounting foot (209-120)

		209-119	500 (50)
--	--	---------	----------

Mounting foot with screw; for DIN-35 rail; can be screwed on terminal blocks with mounting flange; 6.4 mm wide

	gray	209-123	25
--	------	---------	----

Mounting adapter; for DIN-35 rail; can be used as end plate; 6.5 mm wide

	gray	209-137	25
--	------	---------	----

Operating tool with a partially insulated shaft; Type 2; (3.5 x 0.5) mm blade

		210-720	1
--	--	---------	---

Terminal Strip; with Mounting Flanges or Snap-in Mounting Feet 2.5 mm²; 261 Series

Technical Data	
0.08 ... 2.5 mm ²	28 ... 14 AWG
500 V/6 kV/3 ①	300 V, 15 A ②
I _N 24 A	300 V, 20 A ③
Pole width: 6 mm / 0.236 inch	
8 ... 9 mm / 0.31 ... 0.35 inch	

Technical Data	
0.08 ... 2.5 mm ²	28 ... 14 AWG
500 V/6 kV/3 ①	300 V, 15 A ②
I _N 24 A	300 V, 20 A ③
Pole width: 10 mm / 0.394 inch	
8 ... 9 mm / 0.31 ... 0.35 inch	

- ① 500 V = rated voltage
6 kV = rated impulse voltage
3 = pollution degree
(see Section 15)
 - ② Terminal strips with a blue insulated housing are suitable for Ex i applications.
Item no. suffixes .../000-006 (upon request)
 - ③ Longer strips and/or mixed-color assemblies are available upon request.
- Approvals and corresponding ratings, visit www.wago.com



Dimensions in mm

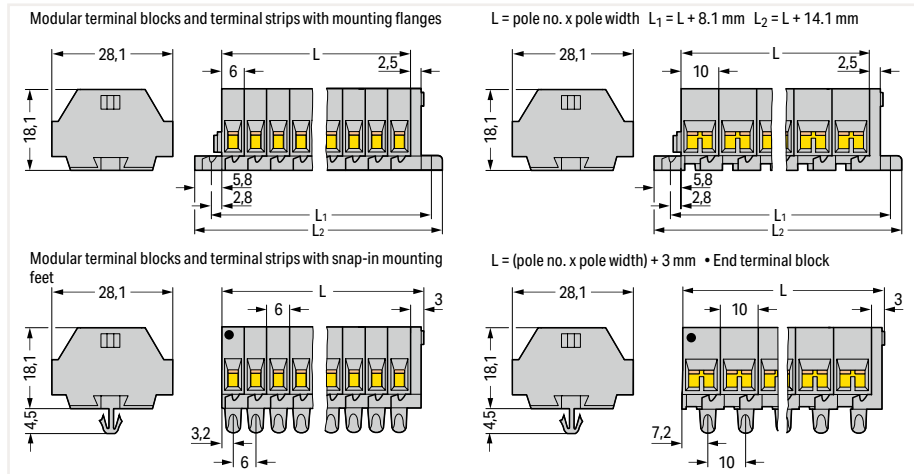

Terminal strip; with mounting flanges; for screw or similar mounting types; 3.2 mm mounting hole diameter (with 209-123 Mounting Foot for DIN-35 rail)



Terminal strip; with snap-in mounting feet; for 0.6 ... 1.2 mm plate thickness; 3.5 mm mounting hole diameter (also for 210-154 Aluminum Rail or with 209-120 Mounting Foot for DIN-35 rail)

2-conductor terminal strip; with mounting flanges; for screw or similar mounting types; 3.2 mm mounting hole diameter; with mounting foot (209-123) also for DIN-35 rail; gray ②

Pole No.	Item No.	Pack. Unit
○ 2	261-102	100
○ 3	261-103	100
○ 4	261-104	100
○ 5	261-105	200
○ 6	261-106	50
○ 7	261-107	50
○ 8	261-108	50
○ 9	261-109	50
○ 10	261-110	25
○ 11	261-111	25
○ 12 ③	261-112	25

4-conductor terminal strip; with mounting flanges; for screw or similar mounting types; 3.2 mm mounting hole diameter; with mounting foot (209-123) also for DIN-35 rail; gray ②

Pole No.	Item No.	Pack. Unit
○ 2	261-202	100
○ 3	261-203	100
○ 4	261-204	100
○ 5	261-205	100
○ 6	261-206	50
○ 7	261-207	50
○ 8	261-208	50
○ 9	261-209	50
○ 10	261-210	25
○ 11	261-211	25
○ 12 ③	261-212	25

2-conductor terminal strip; with snap-in mounting feet; for 0.6 ... 1.2 mm plate thickness; 3.5 mm mounting hole diameter; also for aluminum rail (210-154) or with mounting foot (209-120) for DIN-35 rail; gray ②

Pole No.	Item No.	Pack. Unit
○ 2	261-152	100
○ 3	261-153	100
○ 4	261-154	100
○ 5	261-155	100
○ 6	261-156	50
○ 7	261-157	50
○ 8	261-158	50
○ 9	261-159	50
○ 10	261-160	25
○ 11	261-161	25
○ 12 ③	261-162	25

4-conductor terminal strip; with snap-in mounting feet; for 0.6 ... 1.2 mm plate thickness; 3.5 mm mounting hole diameter; also for aluminum rail (210-154) or with mounting foot (209-120) for DIN-35 rail; gray ②

Pole No.	Item No.	Pack. Unit
○ 2	261-252	100
○ 3	261-253	100
○ 4	261-254	100
○ 5	261-255	100
○ 6	261-256	50
○ 7	261-257	50
○ 8	261-258	50
○ 9	261-259	50
○ 10	261-260	25
○ 11	261-261	25
○ 12 ③	261-262	25

Modular Terminal Block; with Push-Buttons on One Side; with Mounting Flange or Snap-In Mounting Foot

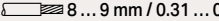

2.5 mm²; 261 Series

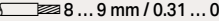
Technical Data	
0.08 ... 2.5 mm ²	28 ... 14 AWG
500 V/6 kV/3 ①	300 V, 15 A ②
I _N 24 A	300 V, 20 A ②
Terminal block width: 6 mm / 0.236 inch	
 8 ... 9 mm / 0.31 ... 0.35 inch	

Technical Data	
0.08 ... 2.5 mm ²	28 ... 14 AWG
500 V/6 kV/3 ①	300 V, 15 A ②
I _N 24 A	300 V, 20 A ②
Terminal block width: 10 mm / 0.394 inch	
 8 ... 9 mm / 0.31 ... 0.35 inch	







2-conductor terminal block; with push-button on one side; with mounting flange; for screw or similar mounting types; 3.2 mm mounting hole diameter; with mounting foot (209-123) also for DIN-35 rail

Color	Item No.	Pack. Unit
 gray	261-301/331-000	200 (50)
 light gray	261-303/331-000	200 (50)
 blue	261-304/331-000 ②	200 (50)
 orange	261-306/331-000	200 (50)
 green-yellow	261-307/331-000	200 (50)





4-conductor terminal block; with push-button on one side; with mounting flange; for screw or similar mounting types; 3.2 mm mounting hole diameter; with mounting foot (209-123) also for DIN-35 rail

Color	Item No.	Pack. Unit
 gray	261-331/332-000	200 (50)
 light gray	261-333/332-000	200 (50)
 blue	261-334/332-000 ②	200 (50)
 orange	261-336/332-000	200 (50)
 green-yellow	261-337/332-000	200 (50)





2-conductor terminal block; with push-button on one side; with snap-in mounting foot; for 0.6 ... 1.2 mm plate thickness; 3.5 mm mounting hole diameter; also for aluminum rail (210-154) or with mounting foot (209-120) for DIN-35 rail

Color	Item No.	Pack. Unit
 gray	261-311/331-000	200 (50)
 light gray	261-313/331-000	200 (50)
 blue	261-314/331-000 ②	200 (50)
 orange	261-316/331-000	200 (50)
 green-yellow	261-317/331-000	200 (50)





4-conductor terminal block; with push-button on one side; with snap-in mounting foot; for 0.6 ... 1.2 mm plate thickness; 3.5 mm mounting hole diameter; also for aluminum rail (210-154) or with mounting foot (209-120) for DIN-35 rail

Color	Item No.	Pack. Unit
 gray	261-341/332-000	200 (50)
 light gray	261-343/332-000	200 (50)
 blue	261-344/332-000 ②	200 (50)
 orange	261-346/332-000	200 (50)
 green-yellow	261-347/332-000	200 (50)

Space-saving 2-conductor end terminal block; with push-button on one side; without protruding snap-in mounting foot; for terminal strips with snap-in mounting feet

Color	Item No.	Pack. Unit
 gray	261-321/331-000	200 (50)
 light gray	261-323/331-000	200 (50)
 blue	261-324/331-000 ②	200 (50)
 orange	261-326/331-000	200 (50)
 green-yellow	261-327/331-000	200 (50)

Space-saving 4-conductor end terminal block; with push-button on one side; without protruding snap-in mounting foot; for terminal strips with snap-in mounting feet

Color	Item No.	Pack. Unit
 gray	261-351/332-000	200 (50)
 light gray	261-353/332-000	200 (50)
 blue	261-354/332-000 ②	200 (50)
 orange	261-356/332-000	200 (50)
 green-yellow	261-357/332-000	200 (50)

Accessories; 261 Series

Marking accessories, see Section 14

End plate; with mounting flange

 gray	261-361	300 (50)
--	---------	----------

End plate; with snap-in mounting foot

 gray	261-371	300 (50)
--	---------	----------

Comb-style jumper bar; insulated; reduces maximum conductor size to 1.5 mm²; I_N 16 A; gray

 2-way	261-402	25
---	---------	----

Operating tool; insulated; for comb-style jumper bar

 2-way	209-132	1
--	---------	---

Test plug; with 500 mm cable; 2 mm Ø; max. 42 V

 red	210-136	50
---	---------	----

Aluminum mounting rail; 1000 mm long; 18 mm wide; 7 mm high

	210-154	1
---	---------	---

Plastic end stop; with WSB marker slot; for aluminum rail (210-154); 6 mm wide

	209-122	25
---	---------	----

① 500 V = rated voltage
6 kV = rated impulse voltage
3 = pollution degree
(see Section 15)

② Terminal blocks with a blue insulated housing are suitable for Ex i applications.

Approvals and corresponding ratings, visit www.wago.com

Accessories; 261 Series

Marking accessories, see Section 14

Mounting foot; for DIN-35 rail; snaps onto terminal blocks with snap-in mounting foot; 6.4 mm wide

 gray	209-120	25
--	---------	----

Mounting screw; for mounting foot (209-120)

	209-119	500 (50)
---	---------	----------

Mounting foot with screw; for DIN-35 rail; can be screwed on terminal blocks with mounting flange; 6.4 mm wide

 gray	209-123	25
--	---------	----

Mounting adapter; for DIN-35 rail; can be used as end plate; 6.5 mm wide

 gray	209-137	25
---	---------	----

Operating tool with a partially insulated shaft; Type 2; (3.5 x 0.5) mm blade

	210-720	1
---	---------	---

9

Terminal Strip; with Push-Buttons on One Side; with Mounting Flanges or Snap-in Mounting Feet 2.5 mm²; 261 Series

Technical Data	
0.08 ... 2.5 mm ²	28 ... 14 AWG
500 V/6 kV/3 ①	
I _N 24 A	
Pole width: 6 mm / 0.236 inch	
8 ... 9 mm / 0.31 ... 0.35 inch	

Technical Data	
0.08 ... 2.5 mm ²	28 ... 14 AWG
500 V/6 kV/3 ①	
I _N 24 A	
Pole width: 10 mm / 0.394 inch	
8 ... 9 mm / 0.31 ... 0.35 inch	

- ① 500 V = rated voltage
6 kV = rated impulse voltage
3 = pollution degree
(see Section 15)
 - ② Terminal strips with a blue insulated housing are suitable for Ex i applications.
Item no. suffixes .../000-006 (upon request)
 - ③ Longer strips and/or mixed-color assemblies are available upon request.
- Approvals and corresponding ratings, visit www.wago.com

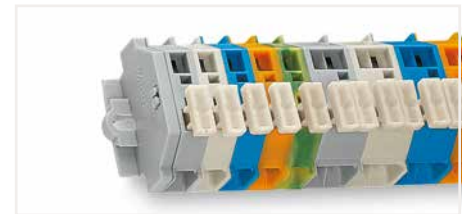
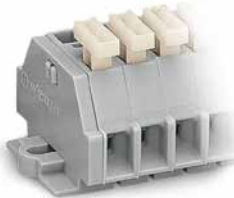

Terminal strip; with mounting flanges; for screw or similar mounting types; 3.2 mm mounting hole diameter (with 209-123 Mounting Foot for DIN-35 rail)

Dimensions in mm

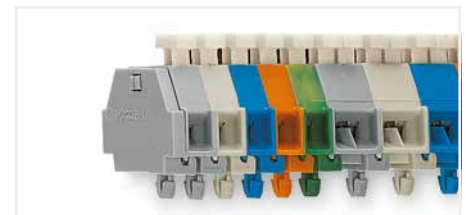
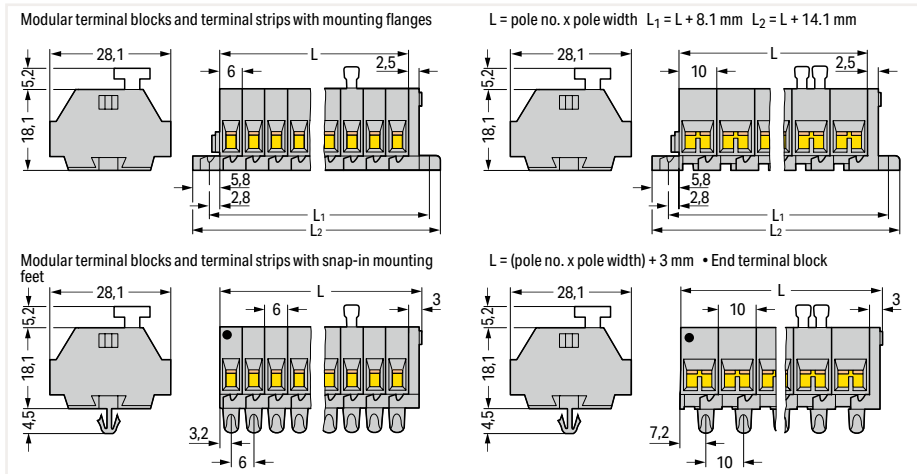

Terminal strip; with snap-in mounting feet; for 0.6 ... 1.2 mm plate thickness; 3.5 mm mounting hole diameter (also for 210-154 Aluminum Rail or with 209-120 Mounting Foot for DIN-35 rail)

2-conductor terminal strip; with push-buttons on one side; with mounting flanges; for screw or similar mounting types; 3.2 mm mounting hole diameter; with mounting foot (209-123) also for DIN-35 rail; gray ②

Pole No.	Item No.	Pack. Unit
○ 2	261-102/331-000	100
○ 3	261-103/331-000	100
○ 4	261-104/331-000	100
○ 5	261-105/331-000	200
○ 6	261-106/331-000	50
○ 7	261-107/331-000	50
○ 8	261-108/331-000	50
○ 9	261-109/331-000	50
○ 10	261-110/331-000	25
○ 11	261-111/331-000	25
○ 12 ③	261-112/331-000	25

4-conductor terminal strip; with push-buttons on one side; with mounting flanges; for screw or similar mounting types; 3.2 mm mounting hole diameter; with mounting foot (209-123) also for DIN-35 rail; gray ②

Pole No.	Item No.	Pack. Unit
○ 2	261-202/332-000	100
○ 3	261-203/332-000	100
○ 4	261-204/332-000	100
○ 5	261-205/332-000	100
○ 6	261-206/332-000	50
○ 7	261-207/332-000	50
○ 8	261-208/332-000	50
○ 9	261-209/332-000	50
○ 10	261-210/332-000	50
○ 11	261-211/332-000	25
○ 12 ③	261-212/332-000	50

2-conductor terminal strip; with push-buttons on one side; with snap-in mounting feet; for 0.6 ... 1.2 mm plate thickness; 3.5 mm mounting hole diameter; also for aluminum rail (210-154) or with mounting foot (209-120) for DIN-35 rail; gray ②

Pole No.	Item No.	Pack. Unit
○ 2	261-152/331-000	100
○ 3	261-153/331-000	100
○ 4	261-154/331-000	100
○ 5	261-155/331-000	100
○ 6	261-156/331-000	50
○ 7	261-157/331-000	50
○ 8	261-158/331-000	50
○ 9	261-159/331-000	50
○ 10	261-160/331-000	25
○ 11	261-161/331-000	25
○ 12 ③	261-162/331-000	25

4-conductor terminal strip; with push-buttons on one side; with snap-in mounting feet; for 0.6 ... 1.2 mm plate thickness; 3.5 mm mounting hole diameter; also for aluminum rail (210-154) or with mounting foot (209-120) for DIN-35 rail; gray ②

Pole No.	Item No.	Pack. Unit
○ 2	261-252/332-000	100
○ 3	261-253/332-000	100
○ 4	261-254/332-000	100
○ 5	261-255/332-000	100
○ 6	261-256/332-000	50
○ 7	261-257/332-000	50
○ 8	261-258/332-000	50
○ 9	261-259/332-000	50
○ 10	261-260/332-000	25
○ 11	261-261/332-000	100
○ 12 ③	261-262/332-000	25

Modular Terminal Block; with Push-Buttons on Both Sides; with Mounting Flange or Snap-In Mounting Foot

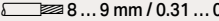

2.5 mm²; 261 Series

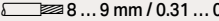
Technical Data	
0.08 ... 2.5 mm ²	28 ... 14 AWG
500 V/6 kV/3 ①	300 V, 15 A ②
I _N 24 A	300 V, 20 A ②
Terminal block width: 6 mm / 0.236 inch	
 8 ... 9 mm / 0.31 ... 0.35 inch	

Technical Data	
0.08 ... 2.5 mm ²	28 ... 14 AWG
500 V/6 kV/3 ①	300 V, 15 A ②
I _N 24 A	300 V, 20 A ②
Terminal block width: 10 mm / 0.394 inch	
 8 ... 9 mm / 0.31 ... 0.35 inch	





2-conductor terminal block; with push-buttons on both sides; with mounting flange; for screw or similar mounting types; 3.2 mm mounting hole diameter; with mounting foot (209-123) also for DIN-35 rail

Color	Item No.	Pack. Unit
 gray	261-301/341-000	200 (50)
 light gray	261-303/341-000	200 (50)
 blue	261-304/341-000 ②	200 (50)
 orange	261-306/341-000	200 (50)
 green-yellow	261-307/341-000	200 (50)





4-conductor terminal block; with push-buttons on both sides; with mounting flange; for screw or similar mounting types; 3.2 mm mounting hole diameter; with mounting foot (209-123) also for DIN-35 rail

Color	Item No.	Pack. Unit
 gray	261-331/342-000	200 (50)
 light gray	261-333/342-000	200 (50)
 blue	261-334/342-000 ②	200 (50)
 orange	261-336/342-000	200 (50)
 green-yellow	261-337/342-000	200 (50)





2-conductor terminal block; with push-buttons on both sides; with snap-in mounting foot; for 0.6 ... 1.2 mm plate thickness; 3.5 mm mounting hole diameter; also for aluminum rail (210-154) or with mounting foot (209-120) for DIN-35 rail

Color	Item No.	Pack. Unit
 gray	261-311/341-000	200 (50)
 light gray	261-313/341-000	200 (50)
 blue	261-314/341-000 ②	200 (50)
 orange	261-316/341-000	200 (50)
 green-yellow	261-317/341-000	200 (50)





4-conductor terminal block; with push-buttons on both sides; with snap-in mounting foot; for 0.6 ... 1.2 mm plate thickness; 3.5 mm mounting hole diameter; also for aluminum rail (210-154) or with mounting foot (209-120) for DIN-35 rail

Color	Item No.	Pack. Unit
 gray	261-341/342-000	200 (50)
 light gray	261-343/342-000	200 (50)
 blue	261-344/342-000 ②	200 (50)
 orange	261-346/342-000	200 (50)
 green-yellow	261-347/342-000	200 (50)

Space-saving 2-conductor end terminal block; with push-buttons on both sides; without protruding snap-in mounting foot; for terminal strips with snap-in mounting feet

Color	Item No.	Pack. Unit
 gray	261-321/341-000	200 (50)
 light gray	261-323/341-000	200 (50)
 blue	261-324/341-000 ②	200 (50)
 orange	261-326/341-000	200 (50)
 green-yellow	261-327/341-000	200 (50)

Space-saving 4-conductor end terminal block; with push-buttons on both sides; without protruding snap-in mounting foot; for terminal strips with snap-in mounting feet

Color	Item No.	Pack. Unit
 gray	261-351/342-000	200 (50)
 light gray	261-353/342-000	200 (50)
 blue	261-354/342-000 ②	200 (50)
 orange	261-356/342-000	200 (50)
 green-yellow	261-357/342-000	200 (50)

Accessories; 261 Series

Marking accessories, see Section 14

End plate; with mounting flange

 gray	261-361	300 (50)
--	---------	----------

End plate; with snap-in mounting foot

 gray	261-371	300 (50)
--	---------	----------

Comb-style jumper bar; insulated; reduces maximum conductor size to 1.5 mm²; I_N 16 A; gray

 2-way	261-402	25
---	---------	----

Operating tool; insulated; for comb-style jumper bar

 2-way	209-132	1
--	---------	---

Test plug; with 500 mm cable; 2 mm Ø; max. 42 V

 red	210-136	50
---	---------	----

Aluminum mounting rail; 1000 mm long; 18 mm wide; 7 mm high

	210-154	1
---	---------	---

Plastic end stop; with WSB marker slot; for aluminum rail (210-154); 6 mm wide

	209-122	25
---	---------	----

① 500 V = rated voltage
6 kV = rated impulse voltage
3 = pollution degree
(see Section 15)

② Terminal blocks with a blue insulated housing are suitable for Ex i applications.

Approvals and corresponding ratings, visit www.wago.com

Accessories; 261 Series

Marking accessories, see Section 14

Mounting foot; for DIN-35 rail; snaps onto terminal blocks with snap-in mounting foot; 6.4 mm wide

 gray	209-120	25
--	---------	----

Mounting screw; for mounting foot (209-120)

	209-119	500 (50)
--	---------	----------

Mounting foot with screw; for DIN-35 rail; can be screwed on terminal blocks with mounting flange; 6.4 mm wide

 gray	209-123	25
--	---------	----

Mounting adapter; for DIN-35 rail; can be used as end plate; 6.5 mm wide

 gray	209-137	25
---	---------	----

Operating tool with a partially insulated shaft; Type 2; (3.5 x 0.5) mm blade

	210-720	1
---	---------	---

Terminal Strip; with Push-Buttons on Both Sides; with Mounting Flanges or Snap-in Mounting Feet

2.5 mm²; 261 Series

Technical Data	
0.08 ... 2.5 mm ²	28 ... 14 AWG
500 V/6 kV/3 ①	
I _N 24 A	
Pole width: 6 mm / 0.236 inch	
8 ... 9 mm / 0.31 ... 0.35 inch	

Technical Data	
0.08 ... 2.5 mm ²	28 ... 14 AWG
500 V/6 kV/3 ①	
I _N 24 A	
Pole width: 10 mm / 0.394 inch	
8 ... 9 mm / 0.31 ... 0.35 inch	

① 500 V = rated voltage
6 kV = rated impulse voltage
3 = pollution degree
(see Section 15)

② Terminal strips with a blue insulated housing are suitable for Ex i applications.
Item no. suffixes .../000-006 (upon request)

③ Longer strips and/or mixed-color assemblies are available upon request.

Approvals and corresponding ratings, visit www.wago.com

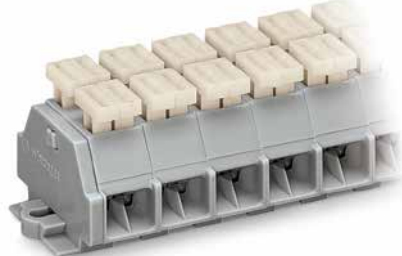
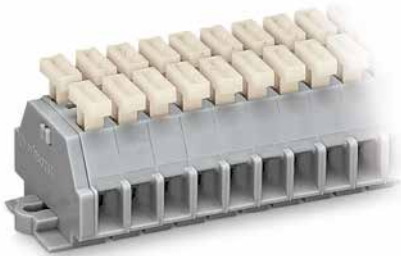

Dimensions in mm

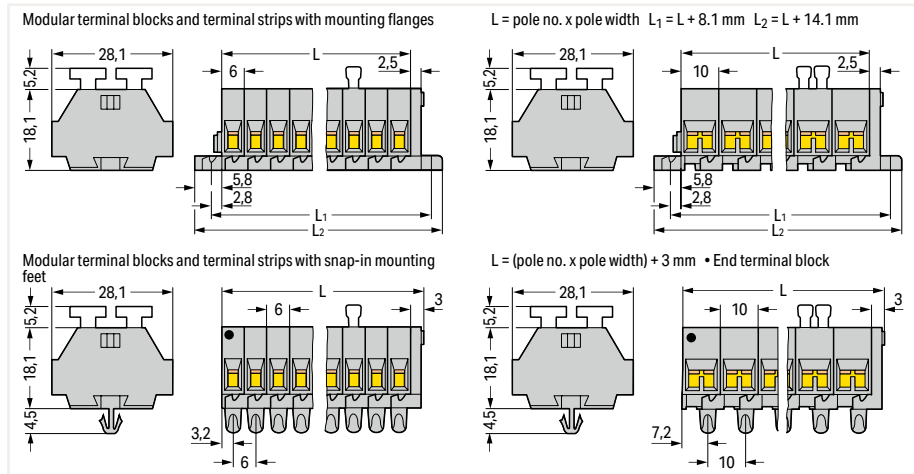

Terminal strip; with mounting flanges; for screw or similar mounting types; 3.2 mm mounting hole diameter (with 209-123 Mounting Foot for DIN-35 rail)



Terminal strip; with snap-in mounting feet; for 0.6 ... 1.2 mm plate thickness; 3.5 mm mounting hole diameter (also for 210-154 Aluminum Rail or with 209-120 Mounting Foot for DIN-35 rail)

2-conductor terminal strip; with push-buttons on both sides; with mounting flanges; for screw or similar mounting types; 3.2 mm mounting hole diameter; with mounting foot (209-123) also for DIN-35 rail; gray ②

Pole No.	Item No.	Pack. Unit
○ 2	261-102/341-000	100
○ 3	261-103/341-000	100
○ 4	261-104/341-000	50
○ 5	261-105/341-000	100
○ 6	261-106/341-000	25
○ 7	261-107/341-000	50
○ 8	261-108/341-000	50
○ 9	261-109/341-000	100
○ 10	261-110/341-000	25
○ 11	261-111/341-000	25
○ 12 ③	261-112/341-000	25

4-conductor terminal strip; with push-buttons on both sides; with mounting flanges; for screw or similar mounting types; 3.2 mm mounting hole diameter; with mounting foot (209-123) also for DIN-35 rail; gray ②

Pole No.	Item No.	Pack. Unit
○ 2	261-202/342-000	100
○ 3	261-203/342-000	100
○ 4	261-204/342-000	100
○ 5	261-205/342-000	100
○ 6	261-206/342-000	50
○ 7	261-207/342-000	50
○ 8	261-208/342-000	100
○ 9	261-209/342-000	50
○ 10	261-210/342-000	25
○ 11	261-211/342-000	25
○ 12 ③	261-212/342-000	50

2-conductor terminal strip; with push-buttons on both sides; with snap-in mounting feet; for 0.6 ... 1.2 mm plate thickness; 3.5 mm mounting hole diameter; also for aluminum rail (210-154) or with mounting foot (209-120) for DIN-35 rail; gray ②

Pole No.	Item No.	Pack. Unit
○ 2	261-152/341-000	100
○ 3	261-153/341-000	100
○ 4	261-154/341-000	50
○ 5	261-155/341-000	100
○ 6	261-156/341-000	100
○ 7	261-157/341-000	50
○ 8	261-158/341-000	50
○ 9	261-159/341-000	50
○ 10	261-160/341-000	25
○ 11	261-161/341-000	25
○ 12 ③	261-162/341-000	100

4-conductor terminal strip; with push-buttons on both sides; with snap-in mounting feet; for 0.6 ... 1.2 mm plate thickness; 3.5 mm mounting hole diameter; also for aluminum rail (210-154) or with mounting foot (209-120) for DIN-35 rail; gray ②

Pole No.	Item No.	Pack. Unit
○ 2	261-252/342-000	100
○ 3	261-253/342-000	100
○ 4	261-254/342-000	100
○ 5	261-255/342-000	100
○ 6	261-256/342-000	50
○ 7	261-257/342-000	50
○ 8	261-258/342-000	50
○ 9	261-259/342-000	50
○ 10	261-260/342-000	25
○ 11	261-261/342-000	100
○ 12 ③	261-262/342-000	25

Modular Terminal Block; with Mounting Flange; with Marker Slot for Mini-WSB Quick Marking System

2.5 mm²; 261 Series

Technical Data

0.08 ... 2.5 mm ²	28 ... 14 AWG
500 V/6 kV/3 ①	300 V, 15 A ②
I _N 24 A	300 V, 20 A ③
Terminal block width: 6 mm / 0.236 inch	
8 ... 9 mm / 0.31 ... 0.35 inch	



- ① 500 V = rated voltage
6 kV = rated impulse voltage
3 = pollution degree
(see Section 15)
- Approvals and corresponding ratings, visit www.wago.com

Accessories; 261 Series
Marking accessories, see Section 14

Mini-WSB marking card; white; 10 strips with 10 markers/
card; 5 mm wide markers

	plain	248-501	5
--	-------	---------	---

Operating tool with a partially insulated shaft; Type 2; (3.5 x 0.5) mm blade

		210-720	1
--	--	---------	---

2-conductor terminal block; with mounting flange; for screw or similar mounting types; 3.2 mm mounting hole diameter; with mounting foot (209-123) also for DIN-35 rail

Color	Item No.	Pack. Unit
○ gray	261-411	200 (50)

2-conductor terminal block; with push-button on one side; with mounting flange; for screw or similar mounting types; 3.2 mm mounting hole diameter; with mounting foot (209-123) also for DIN-35 rail

○ gray	261-411/331-000	200 (50)
--------	-----------------	----------

2-conductor terminal block; with push-buttons on both sides; with mounting flange; for screw or similar mounting types; 3.2 mm mounting hole diameter; with mounting foot (209-123) also for DIN-35 rail

○ gray	261-411/341-000	200 (50)
--------	-----------------	----------

Accessories; 261 Series
Marking accessories, see Section 14

End plate; with mounting flange

	gray	261-410	300 (50)
--	------	---------	----------

Comb-style jumper bar; insulated; reduces maximum conductor size to 1 mm²; I_N 10 A; gray

	2-way	261-402	25
--	-------	---------	----

Operating tool; insulated; for comb-style jumper bar

	2-way	209-132	1
--	-------	---------	---

Test plug; with 500 mm cable; 2 mm Ø; max. 42 V

	red	210-136	50
--	-----	---------	----

Mounting foot with screw, for DIN-35 rail; can be screwed on terminal blocks with mounting flange; 6.4 mm wide

	gray	209-123	25
--	------	---------	----

Mounting adapter; for DIN-35 rail; can be used as end plate; 6.5 mm wide

	gray	209-137	25
--	------	---------	----

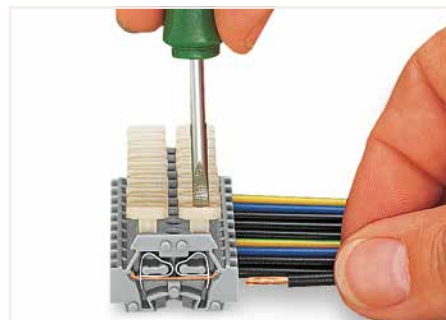

CAGE CLAMP® termination: Inserting a conductor via push-button.

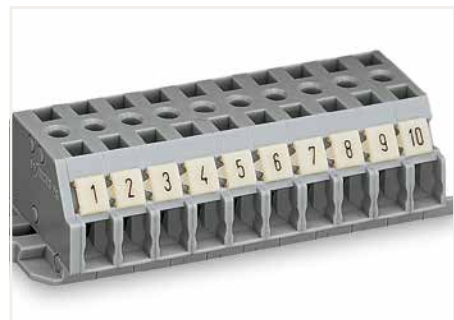

Terminal strip; with marker slot for Mini-WSB Quick Marking System



Testing with voltage tester.

9

Terminal Strip; with Mounting Flanges; with Marker Slot for Mini-WSB Quick Marking System 2.5 mm²; 261 Series

Technical Data	
0.08 ... 2.5 mm ²	28 ... 14 AWG
500 V/6 kV/3 ①	300 V, 15 A ②
I _N 24 A	300 V, 20 A ②
Pole width: 6 mm / 0.236 inch	
8 ... 9 mm / 0.31 ... 0.35 inch	

Technical Data	
0.08 ... 2.5 mm ²	28 ... 14 AWG
500 V/6 kV/3 ①	300 V, 15 A ②
I _N 24 A	300 V, 20 A ②
Pole width: 6 mm / 0.236 inch	
8 ... 9 mm / 0.31 ... 0.35 inch	

- ① 500 V = rated voltage
6 kV = rated impulse voltage
3 = pollution degree
(see Section 15)
 - ② Longer strips are available upon request.
- Approvals and corresponding ratings, visit www.wago.com

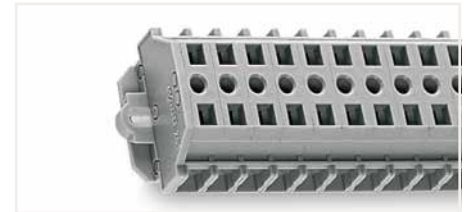
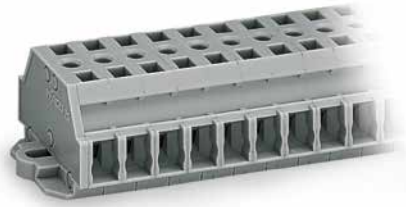

Dimensions in mm

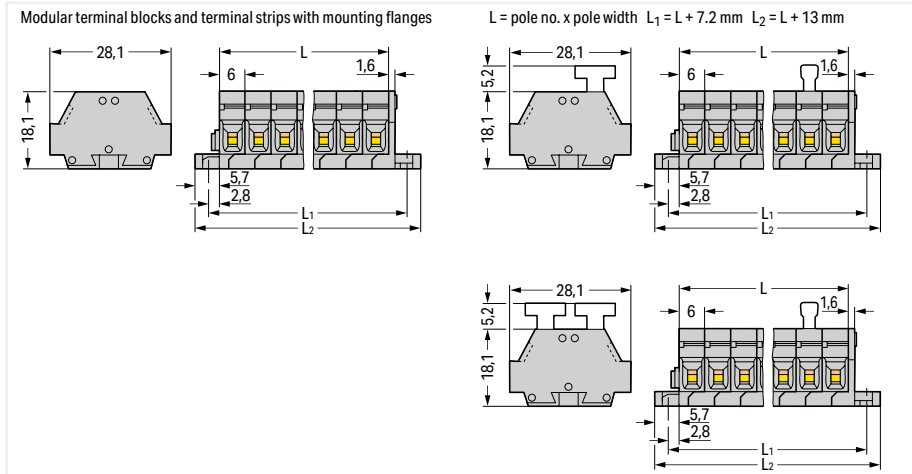

Terminal strip; with mounting flanges; for screw or similar mounting types; 3.2 mm mounting hole diameter (with 209-123 Mounting Foot for DIN-35 rail)



Terminal strip; with mounting flanges; for screw or similar mounting types; 3.2 mm mounting hole diameter (with 209-123 Mounting Foot for DIN-35 rail)

2-conductor terminal strip; with mounting flanges; for screw or similar mounting types; 3.2 mm mounting hole diameter; with mounting foot (209-123) also for DIN-35 rail; gray

Pole No.	Item No.	Pack. Unit
○ 2	261-422	100
○ 3	261-423	100
○ 4	261-424	100
○ 5	261-425	200
○ 6	261-426	50
○ 7	261-427	50
○ 8	261-428	50
○ 9	261-429	50
○ 10	261-430	25
○ 11	261-431	25
○ 12 ②	261-432	25

2-conductor terminal strip; with push-buttons on one side; with mounting flanges; for screw or similar mounting types; 3.2 mm mounting hole diameter; with mounting foot (209-123) also for DIN-35 rail; gray

Pole No.	Item No.	Pack. Unit
○ 2	261-422/331-000	100
○ 3	261-423/331-000	100
○ 4	261-424/331-000	100
○ 5	261-425/331-000	100
○ 6	261-426/331-000	50
○ 7	261-427/331-000	50
○ 8	261-428/331-000	50
○ 9	261-429/331-000	50
○ 10	261-430/331-000	25
○ 11	261-431/331-000	25
○ 12 ②	261-432/331-000	25

2-conductor terminal strip; with push-buttons on both sides; with mounting flanges; for screw or similar mounting types; 3.2 mm mounting hole diameter; with mounting foot (209-123) also for DIN-35 rail; gray

Pole No.	Item No.	Pack. Unit
○ 2	261-422/341-000	100
○ 3	261-423/341-000	100
○ 4	261-424/341-000	100
○ 5	261-425/341-000	100
○ 6	261-426/341-000	50
○ 7	261-427/341-000	50
○ 8	261-428/341-000	50
○ 9	261-429/341-000	50
○ 10	261-430/341-000	25
○ 11	261-431/341-000	25
○ 12 ②	261-432/341-000	25

Modular Terminal Block; with Mounting Flange or Snap-In Mounting Foot 4 mm²; 262 Series

Technical Data	
0.08 ... 4 mm ²	28 ... 12 AWG
630 V/8 kV/3 ①	300 V, 20 A
I _N 24 A	300 V, 20 A
Terminal block width: 7 mm / 0.276 inch	
9 ... 10 mm / 0.35 ... 0.39 inch	

Technical Data	
0.08 ... 4 mm ²	28 ... 12 AWG
630 V/8 kV/3 ①	300 V, 20 A
I _N 32 A	300 V, 20 A
Terminal block width: 12 mm / 0.472 inch	
9 ... 10 mm / 0.35 ... 0.39 inch	

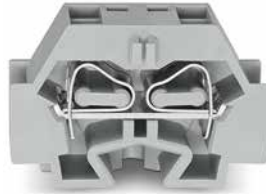
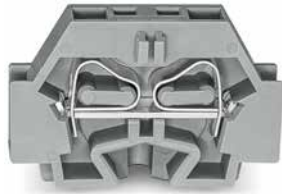

2-conductor terminal block; with mounting flange; for screw or similar mounting types; 3.2 mm mounting hole diameter; with mounting foot (209-123) also for DIN-35 rail

Color	Item No.	Pack. Unit
gray	262-301	100 (50)
blue	262-304 ②	100 (50)
orange	262-306	100 (50)
green-yellow	262-307	100 (50)

4-conductor terminal block; with mounting flange; for screw or similar mounting types; 3.2 mm mounting hole diameter; with mounting foot (209-123) also for DIN-35 rail

Color	Item No.	Pack. Unit
gray	262-331	100 (50)
blue	262-334 ②	100 (50)
orange	262-336	100 (50)
green-yellow	262-337	100 (50)

2-conductor terminal block; with snap-in mounting foot; for 0.6 ... 1.2 mm plate thickness; 3.5 mm mounting hole diameter; also for aluminum rail (210-154) or with mounting foot (209-120) for DIN-35 rail

Color	Item No.	Pack. Unit
gray	262-311	100 (50)
blue	262-314 ②	100 (50)
orange	262-316	100 (50)
green-yellow	262-317	100 (50)

4-conductor terminal block; with snap-in mounting foot; for 0.6 ... 1.2 mm plate thickness; 3.5 mm mounting hole diameter; also for aluminum rail (210-154) or with mounting foot (209-120) for DIN-35 rail

Color	Item No.	Pack. Unit
gray	262-341	100 (50)
blue	262-344 ②	100 (50)
orange	262-346	100 (50)
green-yellow	262-347	100 (50)

Space-saving 2-conductor end terminal block; without protruding snap-in mounting foot; for terminal strips with snap-in mounting feet

Color	Item No.	Pack. Unit
gray	262-321	100 (50)
blue	262-324 ②	100 (50)
orange	262-326	100 (50)
green-yellow	262-327	100 (50)

Space-saving 4-conductor end terminal block; without protruding snap-in mounting foot; for terminal strips with snap-in mounting feet

Color	Item No.	Pack. Unit
gray	262-351	100 (50)
blue	262-354 ②	100 (50)
orange	262-356	100 (50)
green-yellow	262-357	100 (50)

Accessories; item-specific
Test plug module; snaps together; 7 mm wide

gray	249-137	100 (25)
------	---------	----------

Accessories; item-specific
Test plug module; snaps together; 12 mm wide

gray	249-140	100 (25)
------	---------	----------

Accessories; 262 Series
Marking accessories, see Section 14

End plate; with mounting flange

gray	262-361	300 (50)
------	---------	----------

Test plug; with 500 mm cable; 2 mm Ø; max. 42 V

red	210-136	50
-----	---------	----

End plate; with snap-in mounting foot

gray	262-371	300 (50)
------	---------	----------

Aluminum mounting rail; 1000 mm long; 18 mm wide; 7 mm high

	210-154	1
--	---------	---

Comb-style jumper bar; insulated; reduces maximum conductor size to 2.5 mm²; I_N 16 A; gray

2-way	262-402	25
-------	---------	----

Plastic end stop; with WSB marker slot; for aluminum rail (210-154); 6 mm wide

	209-122	25
--	---------	----

Operating tool; insulated; for comb-style jumper bar

2-way	209-132	1
-------	---------	---

① 630 V = rated voltage
8 kV = rated impulse voltage
3 = pollution degree
(see Section 15)

② Terminal blocks with a blue insulated housing are suitable for Ex i applications.

See application notes for:
Test plug module, page 510

Approvals and corresponding ratings,
visit www.wago.com

Accessories; 262 Series
Marking accessories, see Section 14

Mounting foot; for DIN-35 rail; snaps onto terminal blocks with snap-in mounting foot; 6.4 mm wide

gray	209-120	25
------	---------	----

Mounting screw; for mounting foot (209-120)

	209-119	500 (50)
--	---------	----------

Mounting foot with screw; for DIN-35 rail; can be screwed on terminal blocks with mounting flange; 6.4 mm wide

gray	209-123	25
------	---------	----

Mounting adapter; for DIN-35 rail; can be used as end plate; 6.5 mm wide

gray	209-137	25
------	---------	----

Operating tool with a partially insulated shaft; Type 2; (3.5 x 0.5) mm blade

	210-720	1
--	---------	---

9

Terminal Strip; with Mounting Flanges or Snap-in Mounting Feet 4 mm²; 262 Series

Technical Data	
0.08 ... 4 mm ²	28 ... 12 AWG
630 V/8 kV/3 ①	300 V, 20 A ②
I _N 24 A	300 V, 20 A ③
Pole width: 7 mm / 0.276 inch	
9 ... 10 mm / 0.35 ... 0.39 inch	

Technical Data	
0.08 ... 4 mm ²	28 ... 12 AWG
630 V/8 kV/3 ①	300 V, 20 A ②
I _N 32 A	300 V, 20 A ③
Pole width: 12 mm / 0.472 inch	
9 ... 10 mm / 0.35 ... 0.39 inch	

- ① 630 V = rated voltage
8 kV = rated impulse voltage
3 = pollution degree
(see Section 15)
 - ② Terminal strips with a blue insulated housing are suitable for Ex i applications.
Item no. suffixes .../000-006 (upon request)
 - ③ Longer strips and/or mixed-color assemblies are available upon request.
- Approvals and corresponding ratings, visit www.wago.com

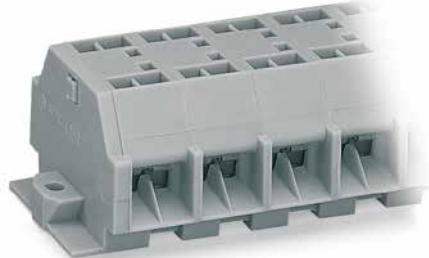
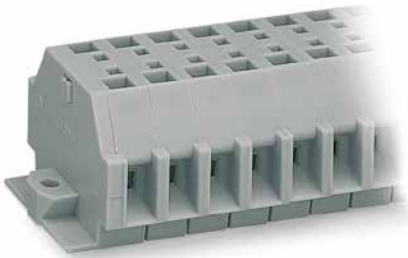

Dimensions in mm

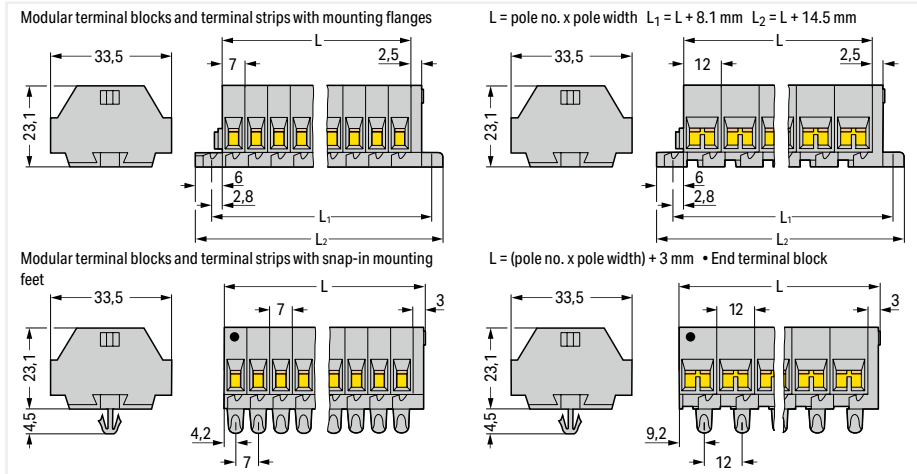

Terminal strip; with mounting flanges; for screw or similar mounting types; 3.2 mm mounting hole diameter (with 209-123 Mounting Foot for DIN-35 rail)



Terminal strip; with snap-in mounting feet; for 0.6 ... 1.2 mm plate thickness; 3.5 mm mounting hole diameter (also for 210-154 Aluminum Rail or with 209-120 Mounting Foot for DIN-35 rail)

2-conductor terminal strip; with mounting flanges; for screw or similar mounting types; 3.2 mm mounting hole diameter; with mounting foot (209-123) also for DIN-35 rail; gray ②

Pole No.	Item No.	Pack. Unit
○ 2	262-102	100
○ 3	262-103	100
○ 4	262-104	100
○ 5	262-105	100
○ 6	262-106	100
○ 7	262-107	100
○ 8	262-108	100
○ 9	262-109	50
○ 10	262-110	25
○ 11	262-111	25
○ 12 ③	262-112	25

4-conductor terminal strip; with mounting flanges; for screw or similar mounting types; 3.2 mm mounting hole diameter; with mounting foot (209-123) also for DIN-35 rail; gray ②

Pole No.	Item No.	Pack. Unit
○ 2	262-202	100
○ 3	262-203	100
○ 4	262-204	100
○ 5	262-205	100
○ 6	262-206	50
○ 7	262-207	50
○ 8	262-208	50
○ 9	262-209	50
○ 10	262-210	25
○ 11	262-211	25
○ 12 ③	262-212	25

2-conductor terminal strip; with snap-in mounting feet; for 0.6 ... 1.2 mm plate thickness; 3.5 mm mounting hole diameter; also for aluminum rail (210-154) or with mounting foot (209-120) for DIN-35 rail; gray ②

Pole No.	Item No.	Pack. Unit
○ 2	262-152	100
○ 3	262-153	100
○ 4	262-154	100
○ 5	262-155	100
○ 6	262-156	50
○ 7	262-157	50
○ 8	262-158	50
○ 9	262-159	50
○ 10	262-160	25
○ 11	262-161	25
○ 12 ③	262-162	25

4-conductor terminal strip; with snap-in mounting feet; for 0.6 ... 1.2 mm plate thickness; 3.5 mm mounting hole diameter; also for aluminum rail (210-154) or with mounting foot (209-120) for DIN-35 rail; gray ②

Pole No.	Item No.	Pack. Unit
○ 2	262-252	100
○ 3	262-253	100
○ 4	262-254	100
○ 5	262-255	100
○ 6	262-256	50
○ 7	262-257	50
○ 8	262-258	50
○ 9	262-259	50
○ 10	262-260	25
○ 11	262-261	25
○ 12 ③	262-262	25

Modular Ex Terminal Block; with Mounting Flange or Snap-In Mounting Foot 4 mm²; 262 Series

Technical Data

0.5 ... 4 mm² ①	28 ... 12 AWG
550 V	300 V, 20 A
I _N 23 A	300 V, 20 A
Terminal block width: 7 mm / 0.276 inch	
9 ... 10 mm / 0.35 ... 0.39 inch	

Technical Data

0.5 ... 4 mm² ①	28 ... 12 AWG
550 V	300 V, 20 A
I _N 30 A	300 V, 20 A
Terminal block width: 12 mm / 0.472 inch	
9 ... 10 mm / 0.35 ... 0.39 inch	

① Using crimped ferrules for corrosion protection, the rated cross section is reduced by one size. For conductor types and conductor preparation, see Section 15 "Electrical Equipment for Hazardous Environments."

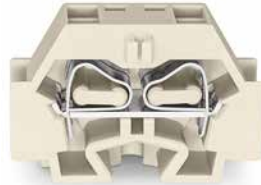

2-conductor Ex e II terminal block; with mounting flange; for screw or similar mounting types; 3.2 mm mounting hole diameter; with mounting foot (209-123) also for DIN-35 rail

Color	Item No.	Pack. Unit
○ light gray	262-130	100 (50)

4-conductor Ex e II terminal block; with mounting flange; for screw or similar mounting types; 3.2 mm mounting hole diameter; with mounting foot (209-123) also for DIN-35 rail

Color	Item No.	Pack. Unit
○ light gray	262-230	100 (50)

2-conductor Ex e II terminal block; with snap-in mounting foot; for 0.6 ... 1.2 mm plate thickness; 3.5 mm mounting hole diameter; also for aluminum rail (210-154) or with mounting foot (209-120) for DIN-35 rail

○ light gray	262-180	100 (50)
--------------	---------	----------

4-conductor Ex e II terminal block; with snap-in mounting foot; for 0.6 ... 1.2 mm plate thickness; 3.5 mm mounting hole diameter; also for aluminum rail (210-154) or with mounting foot (209-120) for DIN-35 rail

○ light gray	262-280	100 (50)
--------------	---------	----------

Space-saving 2-conductor Ex e II end terminal block; without protruding snap-in mounting foot; for terminal strips with snap-in mounting feet

○ light gray	262-181	100 (50)
--------------	---------	----------

Space-saving 4-conductor Ex e II end terminal block; without protruding snap-in mounting foot; for terminal strips with snap-in mounting feet

○ light gray	262-281	100 (50)
--------------	---------	----------

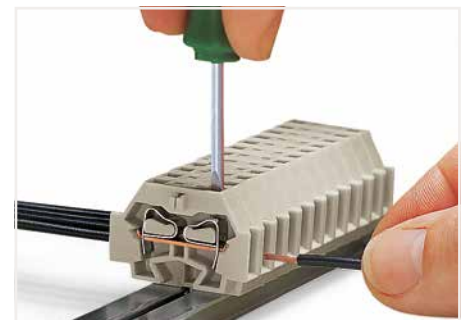

CAGE CLAMP® termination: Inserting a conductor.

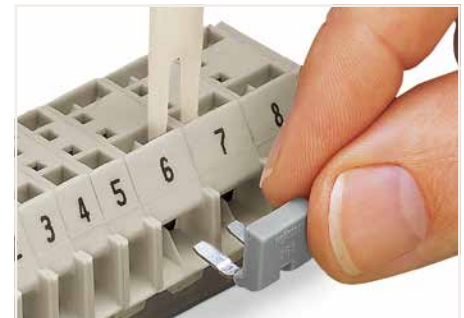

Commoning with comb-style jumper bar.

Accessories; 262 Series

Marking accessories, see Section 14

End plate; with mounting flange

	gray	262-363	50
--	------	---------	----

Mounting foot; for DIN-35 rail; snaps onto terminal blocks with snap-in mounting foot; 6.4 mm wide

	gray	209-120	25
--	------	---------	----

End plate; with snap-in mounting foot

	gray	262-373	50
--	------	---------	----

Mounting screw; for mounting foot (209-120)

		209-119	500 (50)
--	--	---------	----------

Comb-style jumper bar; insulated; reduces maximum conductor size to 2.5 mm²; I_N 16 A; gray

	2-way	262-402	25
--	-------	---------	----

Mounting foot with screw; for DIN-35 rail; can be screwed on terminal blocks with mounting flange; 6.4 mm wide

	gray	209-123	25
--	------	---------	----

Operating tool; insulated; for comb-style jumper bar

	2-way	209-132	1
--	-------	---------	---

Mounting adapter; for DIN-35 rail; can be used as end plate; 6.5 mm wide

	gray	209-137	25
--	------	---------	----

Aluminum mounting rail; 1000 mm long; 18 mm wide; 7 mm high

		210-154	1
--	--	---------	---

Operating tool with a partially insulated shaft; Type 2; (3.5 x 0.5) mm blade

		210-720	1
--	--	---------	---

Plastic end stop; with WSB marker slot; for aluminum rail (210-154); 6 mm wide

		209-122	25
--	--	---------	----

Ex Terminal Strip; with Mounting Flanges or Snap-in Mounting Feet 4 mm²; 262 Series

Technical Data	
0.5 ... 4 mm² ①	28 ... 12 AWG
550 V	300 V, 20 A ②
I _N 23 A	300 V, 20 A ②
Pole width: 7 mm / 0.276 inch	
9 ... 10 mm / 0.35 ... 0.39 inch	

Technical Data	
0.5 ... 4 mm² ①	28 ... 12 AWG
550 V	300 V, 20 A ②
I _N 30 A	300 V, 20 A ②
Pole width: 12 mm / 0.472 inch	
9 ... 10 mm / 0.35 ... 0.39 inch	

① Using crimped ferrules for corrosion protection, the rated cross section is reduced by one size. For conductor types and conductor preparation, see Section 15 "Electrical Equipment for Hazardous Environments."

② Longer strips and/or mixed-color assemblies are available upon request.

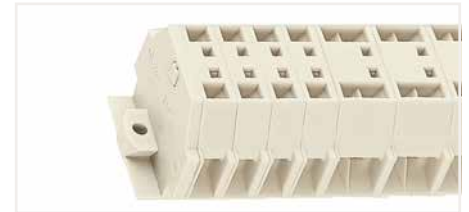
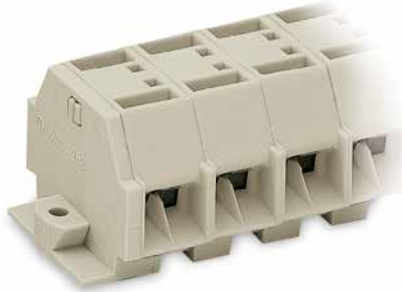

Dimensions in mm

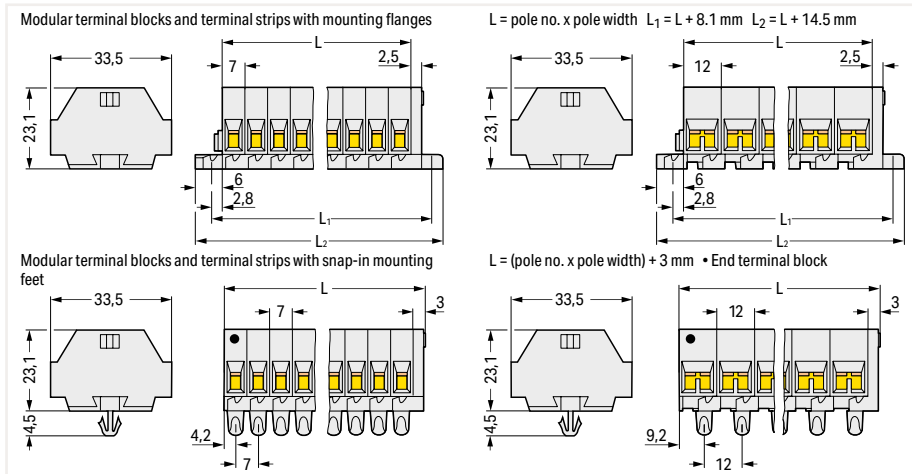

Terminal strip; with mounting flanges; for screw or similar mounting types; 3.2 mm mounting hole diameter (with 209-123 Mounting Foot for DIN-35 rail)



Terminal strip; with snap-in mounting feet; for 0.6 ... 1.2 mm plate thickness; 3.5 mm mounting hole diameter (also for 210-154 Aluminum Rail or with 209-120 Mounting Foot for DIN-35 rail)

2-conductor Ex e II terminal strip; with mounting flanges; for screw or similar mounting types; 3.2 mm mounting hole diameter; with mounting foot (209-123) also for DIN-35 rail; gray

Pole No.	Item No.	Pack. Unit
○ 2 ②	262-132	100
○ 3 ②	262-133	100
○ 4 ②	262-134	100
○ 5 ②	262-135	100
○ 6 ②	262-136	100
○ 7 ②	262-137	50
○ 8 ②	262-138	50
○ 9 ②	262-139	50
○ 10 ②	262-140	25
○ 11 ②	262-141	25
○ 12 ②	262-142	25

4-conductor Ex e II terminal strip; with mounting flanges; for screw or similar mounting types; 3.2 mm mounting hole diameter; with mounting foot (209-123) also for DIN-35 rail; gray

Pole No.	Item No.	Pack. Unit
○ 2 ②	262-232	100
○ 3 ②	262-233	100
○ 4 ②	262-234	100
○ 5 ②	262-235	100
○ 6 ②	262-236	50
○ 7 ②	262-237	50
○ 8 ②	262-238	50
○ 9 ②	262-239	50
○ 10 ②	262-240	25
○ 11 ②	262-241	25
○ 12 ②	262-242	25

2-conductor Ex e II terminal strip; with snap-in mounting feet; for 0.6 ... 1.2 mm plate thickness; 3.5 mm mounting hole diameter; also for aluminum rail (210-154) or with mounting foot (209-120) for DIN-35 rail; gray

Pole No.	Item No.	Pack. Unit
○ 2 ②	262-182	100
○ 3 ②	262-183	100
○ 4 ②	262-184	100
○ 5 ②	262-185	100
○ 6 ②	262-186	50
○ 7 ②	262-187	50
○ 8 ②	262-188	50
○ 9 ②	262-189	50
○ 10 ②	262-190	25
○ 11 ②	262-191	25
○ 12 ②	262-192	25

4-conductor Ex e II terminal strip; with snap-in mounting feet; for 0.6 ... 1.2 mm plate thickness; 3.5 mm mounting hole diameter; also for aluminum rail (210-154) or with mounting foot (209-120) for DIN-35 rail; gray

Pole No.	Item No.	Pack. Unit
○ 2 ②	262-282	100
○ 3 ②	262-283	100
○ 4 ②	262-284	100
○ 5 ②	262-285	100
○ 6 ②	262-286	50
○ 7 ②	262-287	50
○ 8 ②	262-288	50
○ 9 ②	262-289	50
○ 10 ②	262-290	25
○ 11 ②	262-291	25
○ 12 ②	262-292	25

Test Plug Module; for Terminal Strips without Push-Buttons

260, 261 and 262 Series

Technical Data

for 260 Series

Test voltage: 250 V / 500 V ①

Test current: 0.5 A / 6 A ②

Middle pressure: 2.2 N per pole



Technical Data

for 261 Series (also 264 Series)

Test voltage: 400 V / 800 V ①

Test current: 0.5 A / 6 A ②

Middle pressure: 2.2 N per pole



Technical Data

for 262 Series

Test voltage: 500 V / 800 V ①

Test current: 0.5 A / 6 A ②

Middle pressure: 2.2 N per pole



Test plug module; without locking latches; snaps together; for 2-conductor terminal blocks
Module width: 5 mm

Color	Item No.	Pack. Unit
<input type="radio"/> gray	249-135	100 (25)

Test plug module; without locking latches; snaps together; for 2-conductor terminal blocks
Module width: 6 mm

Color	Item No.	Pack. Unit
<input type="radio"/> gray	249-136	100 (25)

Test plug module; without locking latches; snaps together; for 2-conductor terminal blocks
Module width: 7 mm

Color	Item No.	Pack. Unit
<input type="radio"/> gray	249-137	100 (25)

Test plug module; without locking latches; snaps together; for 4-conductor terminal blocks
Module width: 8 mm

<input type="radio"/> gray	249-138	100 (25)
----------------------------	---------	----------

Test plug module; without locking latches; snaps together; for 4-conductor terminal blocks
Module width: 10 mm

<input type="radio"/> gray	249-139	100 (25)
----------------------------	---------	----------

Test plug module; without locking latches; snaps together; for 4-conductor terminal blocks
Module width: 12 mm

<input type="radio"/> gray	249-140	100 (25)
----------------------------	---------	----------

Test plug module; with locking latches; snaps together; for 2-conductor terminal blocks
Module width: 5 mm

<input type="radio"/> gray	260-404	100 (25)
----------------------------	---------	----------

Test plug module; with locking latches; snaps together; for 2-conductor terminal blocks
Module width: 6 mm

<input type="radio"/> gray	261-404	100 (25)
----------------------------	---------	----------

Test plug module; with locking latches; snaps together; for 4-conductor terminal blocks
Module width: 8 mm

<input type="radio"/> gray	260-405	100 (25)
----------------------------	---------	----------

Test plug module; without locking latches; snaps together; for 4-conductor terminal blocks
Module width: 10 mm

<input type="radio"/> gray	261-405	100 (25)
----------------------------	---------	----------

Accessories; for L-type test plug modules

Test plug; with 500 mm cable; 2 mm Ø; max. 42 V

	red	210-136	50
---	-----	---------	----

- 1 Maximum test voltage (touch contact): 48 V (test pins are not touch-proof)
- 2 Maximum test current (touch contact): 0.5 A
Maximum test current: 6 A (if the test pins are securely connected in the clamping units)

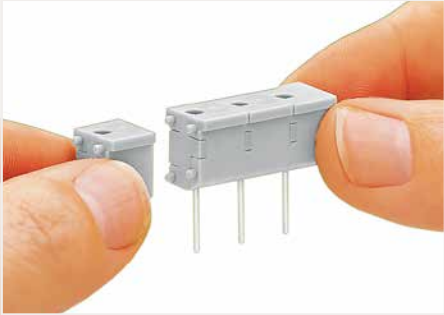

Snapping individual modules together to assemble a multi-pole test plug module.

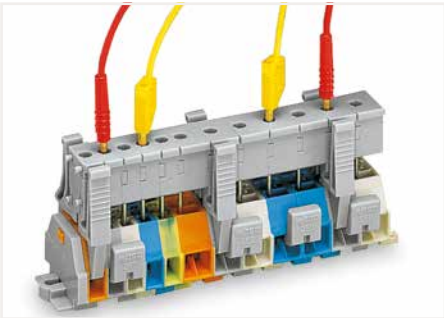

Testing via test plug modules snapped onto a terminal strip – wired or unwired. As touch contact is made with the CAGE CLAMP® (spring steel) unit, this testing type is limited to maximum 0.5 A.

Distance between locking devices must be approximately 35 ... 40 mm.

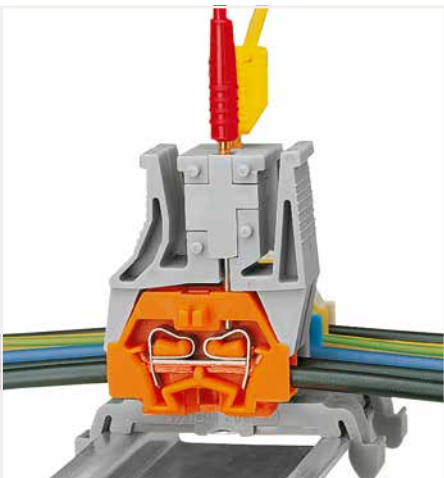

Testing after the conductors have been terminated.





WAGO Chassis-Mount Terminal Strips
WAGO Field-Wiring Terminal Blocks

WAGO Chassis-Mount Terminal Strips

WAGO Field-Wiring Terminal Blocks

Side-Entry Wiring

			Page
	4-Conductor Chassis-Mount Terminal Strips 0.5 ... 4 mm ² (20 ... 12 AWG)	862 Series	516
	Field-Wiring Terminal Blocks 0.5 ... 2.5 mm ² (18 ... 12 AWG)	294 Series	525

4-Conductor Chassis-Mount Terminal Strips

862 Series

Description and Installation

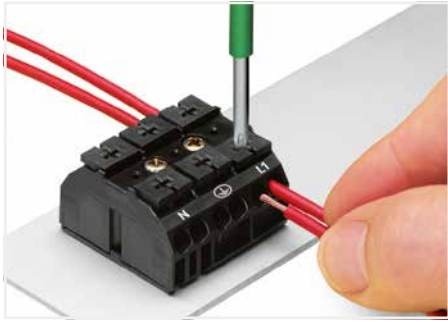

Terminating four conductors per pole – solid and fine-stranded.



Inserting a conductor via push-button.



Testing with a 2 mm Ø test plug (max. 42 V).



Makes an automatic contact to the mounting plate. The plate's varnish is instantly penetrated.



Commoning using a comb-style jumper bar (862-482).

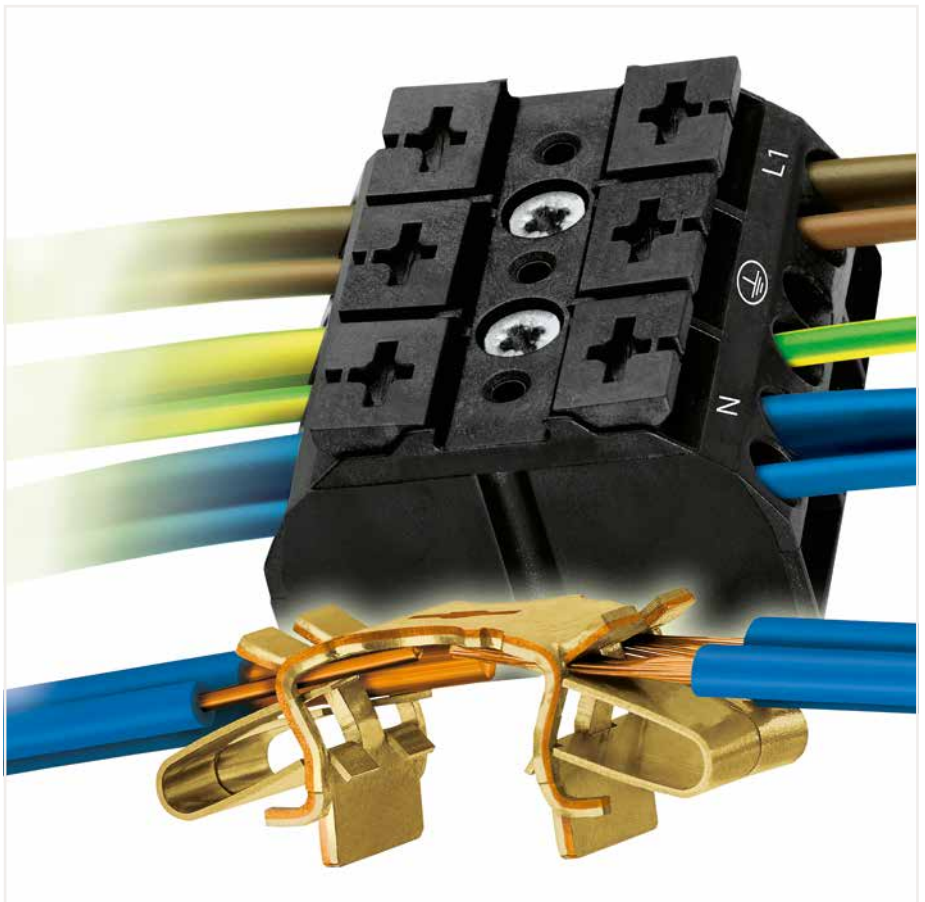

10

Cost-Effective Features:

WAGO's 862 Series Chassis-Mount Terminal Strips were developed specifically to minimize wiring costs, while accommodating requirements for flexible mounting, multiple connection points and easy usage:

- Equipped with Push-in CAGE CLAMP®, the 862 Series connects up to four conductors sized 0.5 to 4 mm² (20 ... 12 AWG). Due to multiple connection points per pole, different conductor sizes can be used within the same terminal block position.

- For factory wiring, Push-in CAGE CLAMP® connection technology allows solid conductors, ultrasonically bonded conductors from 0.5 ... 4 mm² (20 ... 12 AWG; length of bonded conductor end: min. 10 mm) or fine-stranded conductors with ferrules from 1 to 2.5 mm² (18 ... 14 AWG) to be terminated by simply pushing them into the unit.
- Convenient automatic grounding contact (optional)
- Snap-in mounting feet for fast assembly
- Push-buttons for easy installation with an operating tool or by hand
- Built-in test points simplify testing with 2 mm Ø test plug
- Flexible marking options with standard marking (pre-marked), marking strip or custom marked for large orders

Push-in CAGE CLAMP® terminates the following copper conductors:
solid "s" stranded "st"

fine-stranded "f-st", also with tinned single strands

fine-stranded, tip-bonded

fine-stranded, with ferrule (gastight crimped)

fine-stranded, with pin terminal (gastight crimped)

With ferruled conductors, it is necessary to use a terminal block one size smaller than the conductor's nominal cross section.

Mounting Types

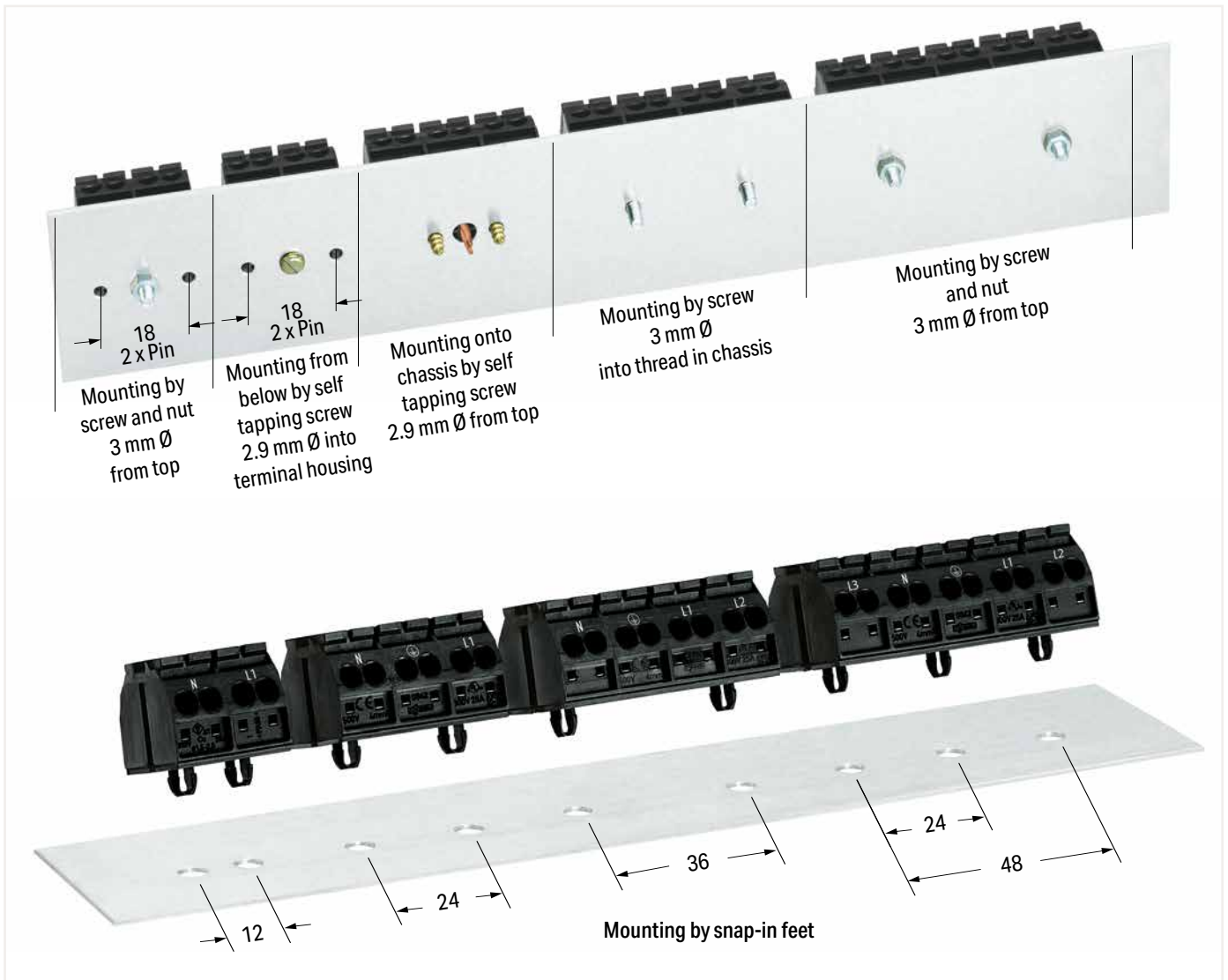

Dimensions in mm

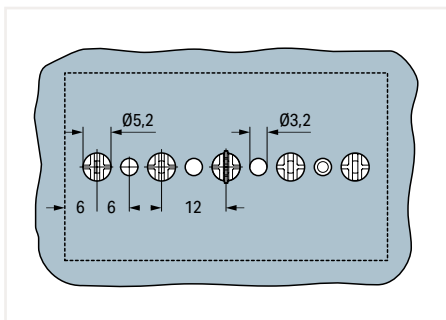

Dimensions (in mm) for ground contact and snap-in mounting foot (5.2 mm Ø)

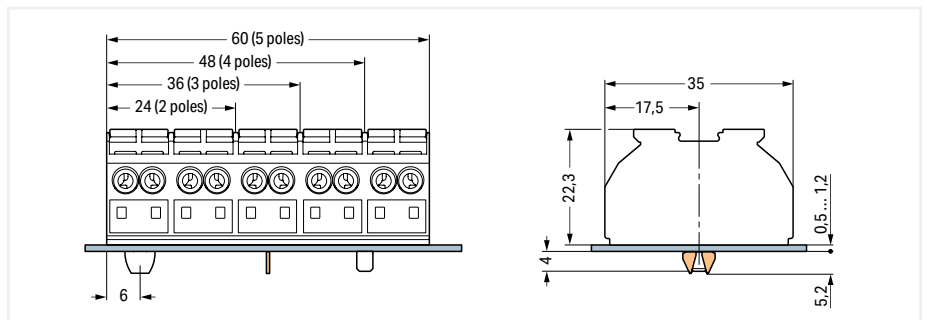

Dimensions (in mm) for chassis-mount terminal strips

4-Conductor Chassis-Mount Terminal Strip; 2-Pole 4 mm²; 862 Series

Technical Data

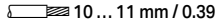
0.5 ... 4 mm ² ①	20 ... 12 AWG
500 V/6 kV/3 ②	300 V, 20 A ③
I _N 32 A	300 V, 20 A ④
 10 ... 11 mm / 0.39 ... 0.43 inch	

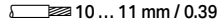

Technical Data

0.5 ... 4 mm ² ①	20 ... 12 AWG
500 V/6 kV/3 ②	300 V, 20 A ③
I _N 32 A	300 V, 20 A ④
 10 ... 11 mm / 0.39 ... 0.43 inch	



① Conductor range: 0.5 ... 4 mm² "s+f-st"; Push-in termination: 1 ... 4 mm² "s" and 1 ... 2.5 mm² "insulated ferrules, 12 mm" Depending on the conductor characteristic, a conductor with a smaller cross section can also be inserted via push-in termination.

② 500 V = rated voltage
6 kV = rated impulse voltage
3 = pollution degree (see Section 15)

③ Terminal blocks with an Ex mark are suitable for Ex e II applications.
440 V; 28 A (see Section 15)

Approvals and corresponding ratings, visit www.wago.com

Accessories; 862 Series

Appropriate marking system:
Marking strips

Comb-style jumper bar; for conductor entry; insulated; terminated conductor entry; I_N 32 A

	black	862-482	5
---	-------	---------	---

Test plug; with 500 mm cable; 2 mm Ø; max. 42 V

	red	210-136	50
---	-----	---------	----

Marking strip; on reel; 7.5 mm wide; not stretchable; plain; snap-on type

	white	709-178	1
---	-------	---------	---

Operating tool with a partially insulated shaft; Type 2; (3.5 x 0.5) mm blade

		210-720	1
---	--	---------	---

4-conductor chassis-mount terminal strip; for mounting via screw and nut (3 mm Ø) or for self-tapping screw (2.9 mm Ø) from top; with 2 x pin; black

	Item No.	Pack. Unit
● N-L1	862-2552	500
● L1-N	862-1552	500
● L1-N ④	862-1552/999-950 ④	500
● plain	862-552	500

4-conductor chassis-mount terminal strip; for mounting via screw and nut (3 mm Ø) or for self-tapping screw (2.9 mm Ø) from top; with 2 x pin; white

	Item No.	Pack. Unit
○ N-L1	862-2652	500
○ L1-N	862-1652	500
○ L1-N ④	862-1652/999-950 ④	500
○ plain	862-652	500

4-conductor chassis-mount terminal strip; for self-tapping screw (2.9 mm Ø) from below; with 2 x pin; black

● N-L1	862-2562	500
● L1-N	862-1562	500
● L1-N ④	862-1562/999-950 ④	500
● plain	862-562	500

4-conductor chassis-mount terminal strip; for self-tapping screw (2.9 mm Ø) from below; with 2 x pin; white

○ N-L1	862-2662	500
○ L1-N	862-1662	500
○ L1-N ④	862-1662/999-950 ④	500
○ plain	862-662	500

4-conductor chassis-mount terminal strip; 1 snap-in foot per pole; black

● N-L1	862-2532	500
● L1-N	862-1532	500
● L1-N ④	862-1532/999-950 ④	500
● plain	862-532	500

4-conductor chassis-mount terminal strip; 1 snap-in foot per pole; white

○ N-L1	862-2632	500
○ L1-N	862-1632	500
○ L1-N ④	862-1632/999-950 ④	500
○ plain	862-632	500

4-Conductor Chassis-Mount Terminal Strip; 3-Pole 4 mm²; 862 Series

Technical Data

0.5 ... 4 mm ² ①	20 ... 12 AWG
500 V/6 kV/3 ②	300 V, 20 A
I _N 32 A	300 V, 20 A
10 ... 11 mm / 0.39 ... 0.43 inch	



Technical Data

0.5 ... 4 mm ² ①	20 ... 12 AWG
500 V/6 kV/3 ②	300 V, 20 A
I _N 32 A	300 V, 20 A
10 ... 11 mm / 0.39 ... 0.43 inch	



① Conductor range: 0.5 ... 4 mm² "s+f-st";
Push-in termination: 1 ... 4 mm² "s" and 1 ... 2.5 mm² "insulated ferrules, 12 mm"
Depending on the conductor characteristic, a conductor with a smaller cross section can also be inserted via push-in termination.

② 500 V = rated voltage
6 kV = rated impulse voltage
3 = pollution degree
(see Section 15)

③ Terminal blocks with an Ex mark are suitable for Ex II applications.
440 V; 28 A
(see Section 15)

Approvals and corresponding ratings,
visit www.wago.com

Accessories; 862 Series

Appropriate marking system:
Marking strips

Comb-style jumper bar; for conductor entry; insulated; terminated conductor entry; I_N 32 A

	black	862-482	5
--	-------	---------	---

Test plug; with 500 mm cable; 2 mm Ø; max. 42 V

	red	210-136	50
--	-----	---------	----

Marking strip; on reel; 7.5 mm wide; not stretchable; plain; snap-on type

	white	709-178	1
--	-------	---------	---

Operating tool with a partially insulated shaft; Type 2; (3.5 x 0.5) mm blade

		210-720	1
--	--	---------	---

4-conductor chassis-mount terminal strip; for mounting via screw and nut (3 mm Ø) or for self-tapping screw (2.9 mm Ø) from top; black

	Item No.	Pack. Unit
● N-PE-L1; without ground contact	862-2503	250
● PE-N-L1; without ground contact	862-1503	250
● PE-N-L1; without ground contact	862-1503/999-950 ③	250
● plain; without ground contact	862-503	250
● N-PE-L1; with ground contact	862-8503	250
● PE-L1-N; with ground contact	862-9503	250

4-conductor chassis-mount terminal strip; for mounting via screw and nut (3 mm Ø) or for self-tapping screw (2.9 mm Ø) from top; white

	Item No.	Pack. Unit
○ N-PE-L1; without ground contact	862-2603	250
○ PE-N-L1; without ground contact	862-1603	250
○ PE-N-L1; without ground contact	862-1603/999-950 ③	250
○ plain; without ground contact	862-603	250
○ N-PE-L1; with ground contact	862-8603	250
○ PE-L1-N; with ground contact	862-9603	250

4-conductor chassis-mount terminal strip; 1 snap-in foot per pole; black

● N-PE-L1; without ground contact	862-2533	250
● PE-N-L1; without ground contact	862-1533	250
● PE-N-L1; without ground contact	862-1533/999-950 ③	250
● plain; without ground contact	862-533	250
● N-PE-L1; with ground contact	862-8533	250
● PE-L1-N; with ground contact	862-9533	250

4-conductor chassis-mount terminal strip; 1 snap-in foot per pole; white

○ N-PE-L1; without ground contact	862-2633	250
○ PE-N-L1; without ground contact	862-1633	250
○ PE-N-L1; without ground contact	862-1633/999-950 ③	250
○ plain; without ground contact	862-633	250
○ N-PE-L1; with ground contact	862-8633	250
○ PE-L1-N; with ground contact	862-9633	250

4-conductor chassis-mount terminal strip; Snap-in foot at pos. 1+3; black

● N-PE-L1; without ground contact	862-2593	250
● PE-N-L1; without ground contact	862-1593	250
● PE-N-L1; without ground contact	862-1593/999-950 ③	250
● plain; without ground contact	862-593	250
● N-PE-L1; with ground contact	862-8593	250
● PE-N-L1; with ground contact	862-9593	250

4-conductor chassis-mount terminal strip; Snap-in foot at pos. 1+3; white

○ N-PE-L1; without ground contact	862-2693	250
○ PE-N-L1; without ground contact	862-1693	250
○ PE-N-L1; without ground contact	862-1693/999-950 ③	250
○ plain; without ground contact	862-693	250
○ N-PE-L1; with ground contact	862-8693	250
○ PE-N-L1; with ground contact	862-9693	250

4-Conductor Chassis-Mount Terminal Strip; 4-Pole 4 mm²; 862 Series

Technical Data	
0.5 ... 4 mm ² ①	20 ... 12 AWG
500 V/6 kV/3 ②	300 V, 20 A
I _N 32 A	300 V, 20 A
10 ... 11 mm / 0.39 ... 0.43 inch	



Technical Data	
0.5 ... 4 mm ² ①	20 ... 12 AWG
500 V/6 kV/3 ②	300 V, 20 A
I _N 32 A	300 V, 20 A
10 ... 11 mm / 0.39 ... 0.43 inch	



- ① Conductor range: 0.5 ... 4 mm² "s+f-st"; Push-in termination: 1 ... 4 mm² "s" and 1 ... 2.5 mm² "insulated ferrules, 12 mm" Depending on the conductor characteristic, a conductor with a smaller cross section can also be inserted via push-in termination.
 - ② 500 V = rated voltage
6 kV = rated impulse voltage
3 = pollution degree (see Section 15)
 - ③ Terminal blocks with an Ex mark are suitable for Ex e II applications.
440 V; 28 A (see Section 15)
- Approvals and corresponding ratings, visit www.wago.com

4-conductor chassis-mount terminal strip; for mounting via screw and nut (3 mm Ø) or for self-tapping screw (2.9 mm Ø) from top; black

	Item No.	Pack. Unit
● N-PE-L1-L2; without ground contact	862-2504	200
● PE-N-L1-L2; without ground contact	862-1504	200
● PE-N-L1-L2; without ground contact	862-1504/999-950 ③	200
● plain; without ground contact	862-504	200
● N-PE-L1-L2; with ground contact	862-8504	200
● PE-N-L1-L2; with ground contact	862-9504	200

4-conductor chassis-mount terminal strip; for mounting via screw and nut (3 mm Ø) or for self-tapping screw (2.9 mm Ø) from top; white

	Item No.	Pack. Unit
○ N-PE-L1-L2; without ground contact	862-2604	200
○ PE-N-L1-L2; without ground contact	862-1604	200
○ PE-N-L1-L2; without ground contact	862-1604/999-950 ③	200
○ plain; without ground contact	862-604	200
○ N-PE-L1-L2; with ground contact	862-8604	200
○ PE-N-L1-L2; with ground contact	862-9604	200

Accessories; 862 Series
Appropriate marking system:
Marking strips

Comb-style jumper bar; for conductor entry; insulated; terminated conductor entry; I_N 32 A

	black	862-482	5
--	-------	---------	---

Test plug; with 500 mm cable; 2 mm Ø; max. 42 V

	red	210-136	50
--	-----	---------	----

Marking strip; on reel; 7.5 mm wide; not stretchable; plain; snap-on type

	white	709-178	1
--	-------	---------	---

Operating tool with a partially insulated shaft; Type 2; (3.5 x 0.5) mm blade

		210-720	1
--	--	---------	---

4-conductor chassis-mount terminal strip; 1 snap-in foot per pole; black

	Item No.	Pack. Unit
● N-PE-L1-L2; without ground contact	862-2534	200
● PE-N-L1-L2; without ground contact	862-1534	200
● PE-N-L1-L2; without ground contact	862-1534/999-950 ③	200
● plain; without ground contact	862-534	200
● N-PE-L1-L2; with ground contact	862-8534	200
● PE-N-L1-L2; with ground contact	862-9534	200

4-conductor chassis-mount terminal strip; 1 snap-in foot per pole; white

	Item No.	Pack. Unit
○ N-PE-L1-L2; without ground contact	862-2634	200
○ PE-N-L1-L2; without ground contact	862-1634	200
○ PE-N-L1-L2; without ground contact	862-1634/999-950 ③	200
○ plain; without ground contact	862-634	200
○ N-PE-L1-L2; with ground contact	862-8634	200
○ PE-N-L1-L2; with ground contact	862-9634	200

4-conductor chassis-mount terminal strip; Snap-in foot at pos. 1+4; black

	Item No.	Pack. Unit
● N-PE-L1-L2; without ground contact	862-2594	200
● PE-N-L1-L2; without ground contact	862-1594	200
● PE-N-L1-L2; without ground contact	862-1594/999-950 ③	200
● plain; without ground contact	862-594	200
● N-PE-L1-L2; with ground contact	862-8594	200
● PE-N-L1-L2; with ground contact	862-9594	200

4-conductor chassis-mount terminal strip; Snap-in foot at pos. 1+4; white

	Item No.	Pack. Unit
○ N-PE-L1-L2; without ground contact	862-2694	200
○ PE-N-L1-L2; without ground contact	862-1694	200
○ PE-N-L1-L2; without ground contact	862-1694/999-950 ③	200
○ plain; without ground contact	862-694	200
○ N-PE-L1-L2; with ground contact	862-8694	200
○ PE-N-L1-L2; with ground contact	862-9694	200

10

4-Conductor Chassis-Mount Terminal Strip; 5-Pole 4 mm²; 862 Series

Technical Data

0.5 ... 4 mm ² ①	20 ... 12 AWG
500 V/6 kV/3 ②	300 V, 20 A
I _N 32 A	300 V, 20 A
10 ... 11 mm / 0.39 ... 0.43 inch	



Technical Data

0.5 ... 4 mm ² ①	20 ... 12 AWG
500 V/6 kV/3 ②	300 V, 20 A
I _N 32 A	300 V, 20 A
10 ... 11 mm / 0.39 ... 0.43 inch	



① Conductor range: 0.5 ... 4 mm² "s+f-st";
Push-in termination: 1 ... 4 mm² "s" and 1 ... 2.5 mm² "insulated ferrules, 12 mm"
Depending on the conductor characteristic, a conductor with a smaller cross section can also be inserted via push-in termination.

② 500 V = rated voltage
6 kV = rated impulse voltage
3 = pollution degree
(see Section 15)

③ Terminal blocks with an Ex mark are suitable for Ex e II applications.
440 V; 28 A
(see Section 15)

Approvals and corresponding ratings,
visit www.wago.com

Accessories; 862 Series

Appropriate marking system:
Marking strips

Comb-style jumper bar; for conductor entry; insulated; terminated conductor entry; I_N 32 A

	black	862-482	5
--	-------	---------	---

Test plug; with 500 mm cable; 2 mm Ø; max. 42 V

	red	210-136	50
--	-----	---------	----

Marking strip; on reel; 7.5 mm wide; not stretchable; plain; snap-on type

	white	709-178	1
--	-------	---------	---

Operating tool with a partially insulated shaft; Type 2; (3.5 x 0.5) mm blade

		210-720	1
--	--	---------	---

4-conductor chassis-mount terminal strip; for mounting via screw and nut (3 mm Ø) or for self-tapping screw (2.9 mm Ø) from top; black

	Item No.	Pack. Unit
● L3-N-PE-L1-L2; without ground contact	862-2505	200
● PE-N-L1-L2-L3; without ground contact	862-1505	200
● PE-N-L1-L2-L3; without ground contact	862-1505/999-950 ③	200
● plain; without ground contact	862-505	200
● L3-N-PE-L1-L2; with ground contact	862-8505	200
● PE-N-L1-L2-L3; with ground contact	862-9505	200

4-conductor chassis-mount terminal strip; for mounting via screw and nut (3 mm Ø) or for self-tapping screw (2.9 mm Ø) from top; white

	Item No.	Pack. Unit
○ L3-N-PE-L1-L2; without ground contact	862-2605	200
○ PE-N-L1-L2-L3; without ground contact	862-1605	200
○ PE-N-L1-L2-L3; without ground contact	862-1605/999-950 ③	200
○ plain; without ground contact	862-605	200
○ L3-N-PE-L1-L2; with ground contact	862-8605	200
○ PE-N-L1-L2-L3; with ground contact	862-9605	200

4-conductor chassis-mount terminal strip; 1 snap-in foot per pole; black

● L3-N-PE-L1-L2; without ground contact	862-2525	200
● PE-N-L1-L2-L3; without ground contact	862-1525	200
● PE-N-L1-L2-L3; without ground contact	862-1525/999-950 ③	200
● plain; without ground contact	862-525	200
● L3-N-PE-L1-L2; with ground contact	862-8525	200
● PE-N-L1-L2-L3; with ground contact	862-9525	200

4-conductor chassis-mount terminal strip; 1 snap-in foot per pole; white

○ L3-N-PE-L1-L2; without ground contact	862-2625	200
○ PE-N-L1-L2-L3; without ground contact	862-1625	200
○ PE-N-L1-L2-L3; without ground contact	862-1625/999-950 ③	200
○ plain; without ground contact	862-625	200
○ L3-N-PE-L1-L2; with ground contact	862-8625	200
○ PE-N-L1-L2-L3; with ground contact	862-9625	200

4-conductor chassis-mount terminal strip; Snap-in foot at pos. 1+3+5; black

● L3-N-PE-L1-L2; without ground contact	862-2515	200
● PE-N-L1-L2-L3; without ground contact	862-1515	200
● PE-N-L1-L2-L3; without ground contact	862-1515/999-950 ③	200
● plain; without ground contact	862-515	200
● L3-N-PE-L1-L2; with ground contact	862-8515	200
● PE-N-L1-L2-L3; with ground contact	862-9515	200

4-conductor chassis-mount terminal strip; Snap-in foot at pos. 1+3+5; white

○ L3-N-PE-L1-L2; without ground contact	862-2615	200
○ PE-N-L1-L2-L3; without ground contact	862-1615	200
○ PE-N-L1-L2-L3; without ground contact	862-1615/999-950 ③	200
○ plain; without ground contact	862-615	200
○ L3-N-PE-L1-L2; with ground contact	862-8615	200
○ PE-N-L1-L2-L3; with ground contact	862-9615	200

Connect Lighting and Equipment Worldwide

Contact Technology

294 Series

Contact Technology

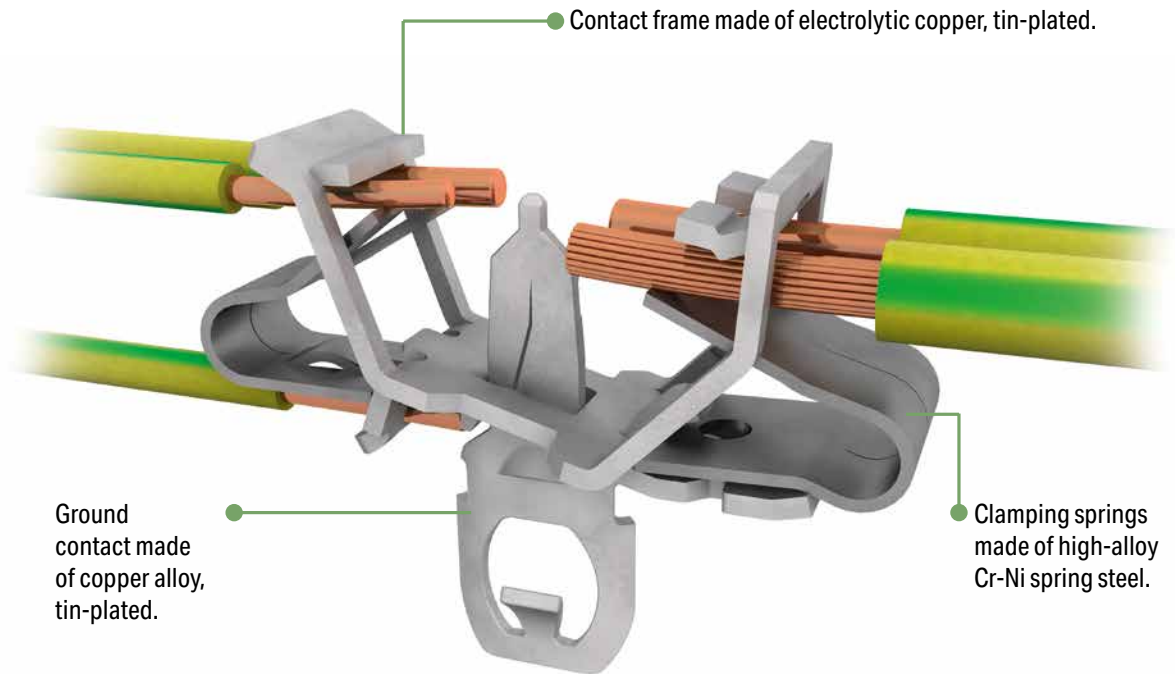

10

EUROPE
1 x 0.5 ... 2.5 mm ² "s"
1 x 0.5 ... 1.5 mm ² "s"
1 x 0.5 ... 0.75 mm ² "s"
AMERICA
1 x AWG 18 ... 14 "s"
1 x AWG 18 ... 16 "s"
1 x AWG 18 "s"
JAPAN
1 x 0.8 ... 1.6 mm diam. "s"
1 x 0.8 ... 1 mm diam. "s"
1 x 0.8 mm diam. "s"

Internal connection:
 PUSH WIRE® for internal wiring with solid conductors

EUROPE
2 x 0.5 ... 2.5 mm ² "s, str, f-str"
AMERICA
2 x AWG 18 ... 12 "s"
2 x AWG 18 ... 14 "s, f-str"
JAPAN
2 x 0.8 ... 2 mm diam. "s"
2 x 0.5 ... 2 mm ² "str, f-str"

External connection:
 Push-in CAGE CLAMP® for field-wiring with all conductor types

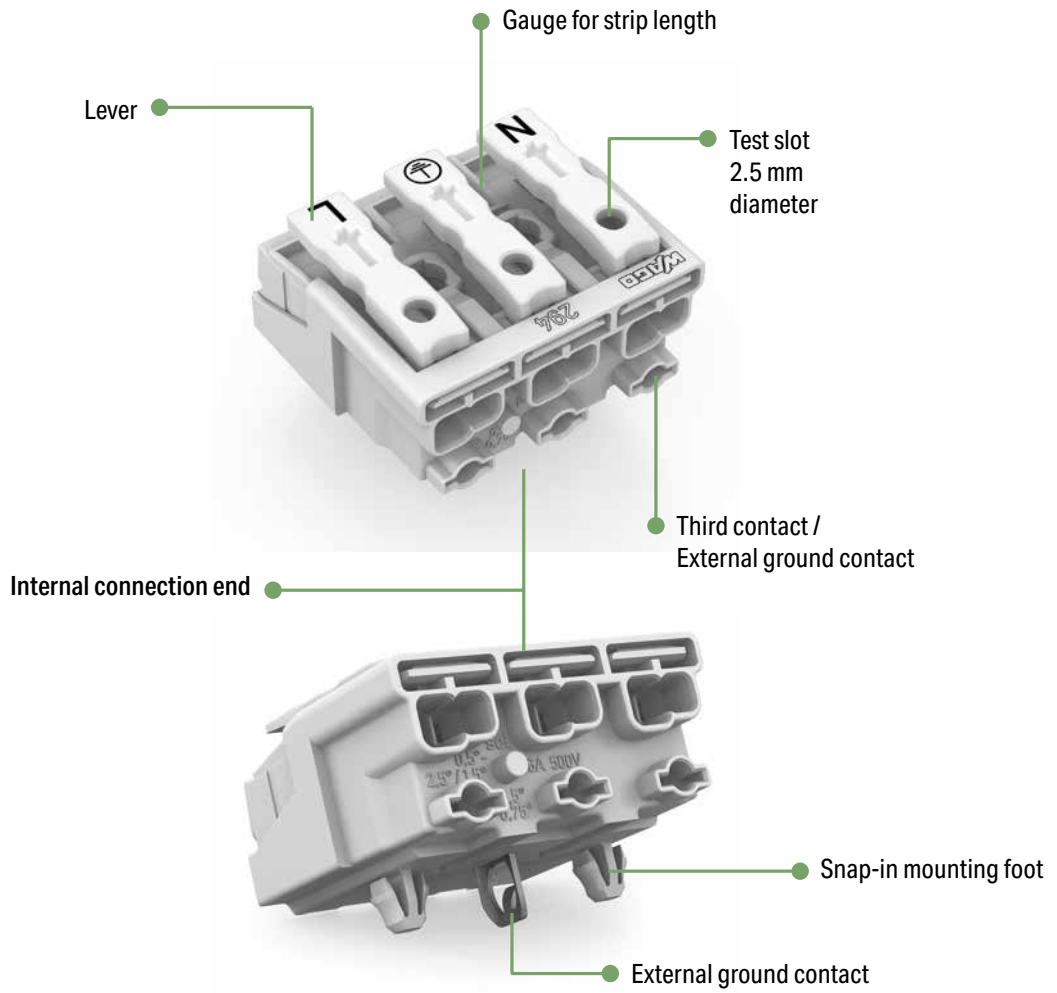

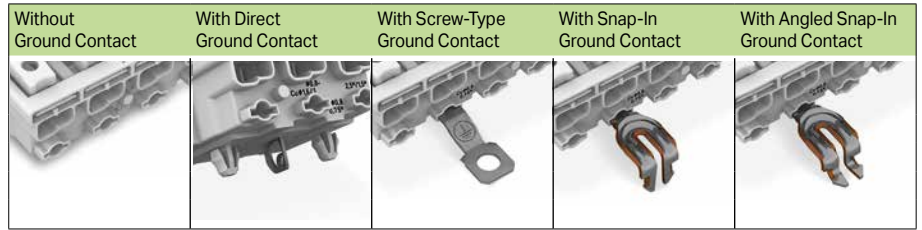
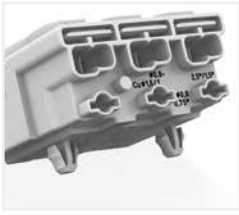

PUSH-IN CAGE CLAMP® / PUSH WIRE®

Field-Wiring Terminal Block; with Two Snap-In Mounting Feet – Overview 294 Series



Pole No.	Marking	Item No.	Item No.	Item No.	Item No.	Item No.
2 	plain	294-5002				
	N-L	294-5012				
	N`-L`	294-5022				
	DA- DA+	294-5032				
	- +	294-5072				
	1-N	294-5052				
	2-1	294-5042				

3 	plain	294-5003				
	N-PE-L	294-5013	294-5113	294-5413	294-5213	294-5313
	N`-PE-L`	294-5023	294-5123	294-5423	294-5223	294-5323
	1-PE-N	294-5053	294-5153	294-5453	294-5253	294-5353
	3-2-1	294-5043				

4 	plain	294-5004				
	1/L`-2/L-PE-N	294-5024	294-5124	294-5424	294-5224	294-5324
	1-2-PE-N	294-5014	294-5114	294-5414	294-5214	294-5314
	4-3-2-1	294-5044				
	1/L`-2/L E-N	294-5094/4025-000				

5 	plain	294-5005				
	L3-L2-L1-PE_N	294-5015		294-5415	294-5215	294-5315
	L`-N`-L-PE-N	294-5025		294-5425	294-5225	294-5325
	DA+ DA- L PE N	294-5035		294-5435	294-5235	294-5335
	DA- N PE L DA+	294-5075	294-5175	294-5475	294-5275	294-5375
	3-N-PE-1-2	294-5055	294-5155	294-5455	294-5255	294-5355
	5-4-3-2-1	294-5045				
	DA+ DA- L E N	294-5095/5025-000				
	L3-L2-L1-E-N	294-5095/5026-000				
	L`-N`-L-E-N	294-5095/5027-000				

10

Field-Wiring Terminal Block; without Snap-In Mounting Feet – Overview 294 Series

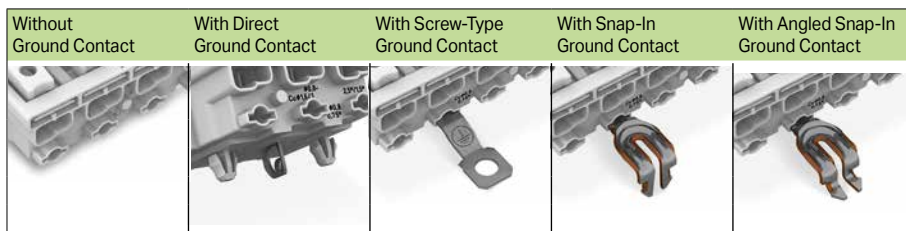



Pole No.	Marking	Item No.	Item No.	Item No.	Item No.	Item No.
2 	plain	294-4002				
	N-L	294-4012				
	N`-L`	294-4022				
	DA- DA+	294-4032				
	- +	294-4072				
	1-N	294-4052				
	2-1	294-4042				

3 	plain	294-4003				
	N-PE-L	294-4013		294-4413	294-4213	294-4313
	N`-PE-L`	294-4023		294-4423	294-4223	294-4323
	1-PE-N	294-4053		294-4453	294-4253	294-4353
	3-2-1	294-4043				

4 	plain	294-4004				
	1/L`-2/L-PE-N	294-4024		294-4424	294-4224	294-4324
	1-2-PE-N	294-4014		294-4414	294-4214	294-4314
	4-3-2-1	294-4044				
	1/L`-2/L E-N	294-4094/4025-000				

5 	plain	294-4005				
	L3-L2-L1-PE_N	294-4015		294-4415	294-4215	294-4315
	L`-N`-L-PE-N	294-4025		294-4425	294-4225	294-4325
	DA+ DA- L PE N	294-4035		294-4435	294-4235	294-4335
	DA- N PE L DA+	294-4075		294-4475	294-4275	294-4375
	3-N-PE-1-2	294-4055		294-4455	294-4255	294-4355
	5-4-3-2-1	294-4045				
	DA+ DA- L E N	294-4095/5025-000				
	L3-L2-L1-E-N	294-4095/5026-000				
	L`-N`-L-E-N	294-4095/5027-000				

6 	plain	294-4006				
--	-------	----------	--	--	--	--

7 	plain	294-4007				
--	-------	----------	--	--	--	--

10

Field-Wiring Terminal Block

2.5 mm; 294 Series



Terminating five conductors per pole – solid and fine-stranded.

- External connection of solid, stranded and fine-stranded conductors
- Universal conductor termination (AWG, metric)
- Third contact located at the bottom of internal connection end
- Strain relief plate can be retrofitted

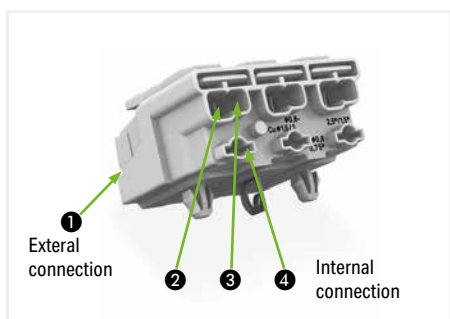

Technical Data

	IEC/EN 60998-1	IEC/EN 60998-2-2
Ratings per		
Overvoltage category	II	II
Pollution degree	2	2
Rated voltage	500 V	500 V
Rated surge voltage	4 kV	4 kV
Rated current	24 A	24 A
Temperature specification	T 85	

Conductor Data (External Connection)

Connection technology ①	Push-in CAGE CLAMP®
Solid conductor	0.5 ... 2.5 mm / 18 ... 12 AWG
Stranded conductor	0.5 ... 2.5 mm / 18 ... 16 AWG
Fine-stranded conductor	0.5 ... 2.5 mm / 18 ... 16 AWG
Solid conductor, push-in termination	0.5 ... 2.5 mm / 18 ... 12 AWG
Fine-stranded conductor with ferrule, push-in termination	0.5 mm ² / 18 AWG
Fine-stranded conductor with ferrule with plastic collar	0.5 ... 1.5 mm / 18 ... 16 AWG
Fine-stranded conductor with ferrule without plastic collar	0.5 ... 1.5 mm / 18 ... 16 AWG

Conductor Data (Internal Connection)

Connection technology	PUSH WIRE®
Conductor termination ②	
Solid conductor	0.5 ... 2.5 mm / 18 ... 14 AWG
Fine-stranded conductor with ferrule without plastic collar	0.5 ... 1.5 mm / 18 ... 14 AWG
Fine-stranded conductor with ferrule with plastic collar	0.5 ... 1.5 mm / 18 ... 14 AWG
Conductor termination ③	
Solid conductor	0.5 ... 1.5 mm / 18 ... 16 AWG
Fine-stranded conductor with ferrule without plastic collar	0.5 ... 1 mm / 18 ... 14 AWG
Fine-stranded conductor with ferrule with plastic collar	0.5 ... 0.75 mm / 18 AWG
Conductor termination ④	
Solid conductor	0.5 ... 0.75 mm / 18 AWG
Strip length	8 ... 9 mm / 0.31 ... 0.35 inch

Material Data

Material group	IIIa
Insulation material	Polycarbonate (PC)
Temperature stability	Relative Temperature Index (RTI) of 120 °C
Flammability class per UL 94	V0
Clamping spring material	Chrome nickel spring steel (CrNi)
Contact material	Electrolytic copper (E _{cu})
Contact plating	Tin-plated
16 mm-high versions are available upon request.	

Field-Wiring Terminal Block

2.5 mm; 294 Series

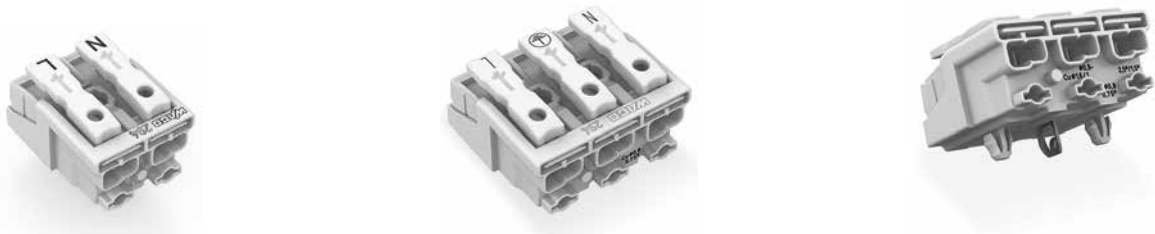

Dimensions in mm

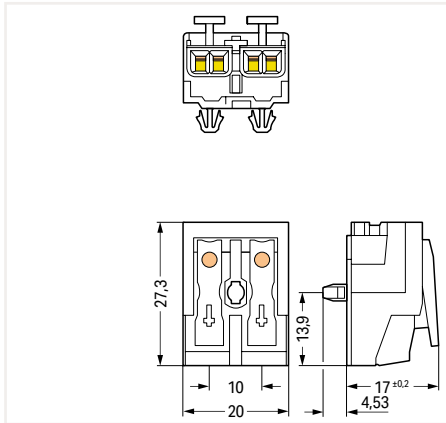

Field-wiring terminal block; without ground contact; with snap-in mounting feet; 2-pole; white

Marking	Item No.	Pack. Unit
○ N-L	294-5012	1000
○ N'-L'	294-5022	1000
○ DA- DA+	294-5032	1000
○ - +	294-5072	1000
○ 2-1	294-5042	1000
○ 1-N	294-5052	1000
○ plain	294-5002	1000

Dimensions in mm

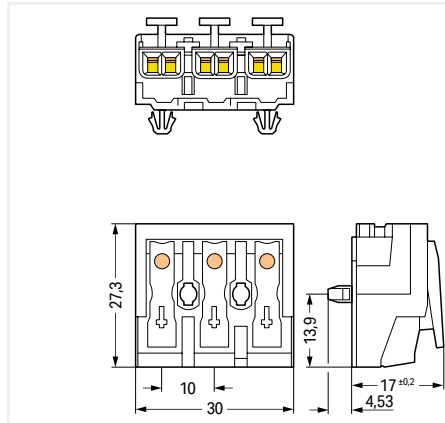

Field-wiring terminal block; without ground contact; with snap-in mounting feet; 3-pole; white

Marking	Item No.	Pack. Unit
○ N-PE-L	294-5013	500
○ N'-PE-L'	294-5023	500
○ 1-PE-N	294-5053	500
○ 3-2-1	294-5043	500
○ plain	294-5003	500

Dimensions in mm

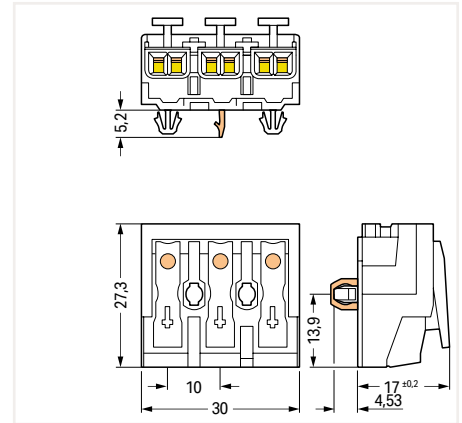

Field-wiring terminal block; with direct ground contact; with snap-in mounting feet; 3-pole; white

Marking	Item No.	Pack. Unit
○ N-PE-L	294-5113	500
○ N'-PE-L'	294-5123	500
○ 1-PE-N	294-5153	500

Field-wiring terminal block; without ground contact; without snap-in mounting feet; 2-pole; white

○ N-L	294-4012	1000
○ N'-L'	294-4022	1000
○ DA- DA+	294-4032	1000
○ - +	294-4072	1000
○ 2-1	294-4042	1000
○ 1-N	294-4052	1000
○ plain	294-4002	1000

Field-wiring terminal block; without ground contact; without snap-in mounting feet; 3-pole; white

○ N-PE-L	294-4013	500
○ N'-PE-L'	294-4023	500
○ 1-PE-N	294-4053	500
○ 3-2-1	294-4043	500
○ plain	294-4003	500
○ N-E-L	294-4093/3025-000	500

Field-Wiring Terminal Block

2.5 mm; 294 Series

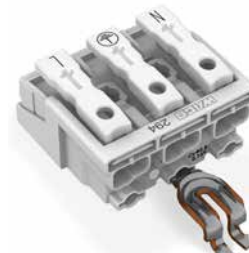
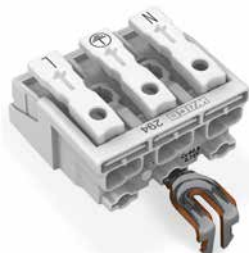

Dimensions in mm

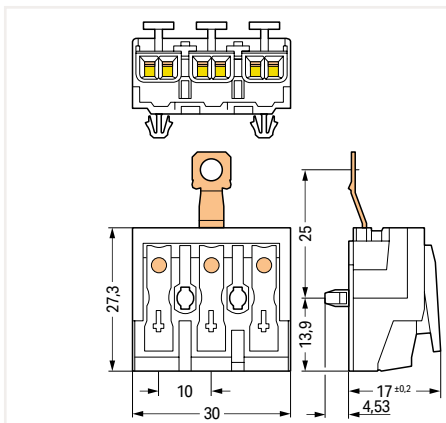

Field-wiring terminal block; with screw-type ground contact; with snap-in mounting feet; 3-pole; white

Marking	Item No.	Pack. Unit
○ N-PE-L	294-5413	500
○ N'-PE-L'	294-5423	500
○ 1-PE-N	294-5453	500

Dimensions in mm

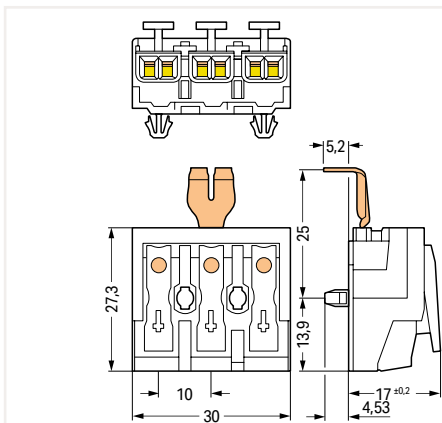

Field-wiring terminal block; with ground contact; with snap-in mounting feet; 3-pole; white

Marking	Item No.	Pack. Unit
○ N-PE-L	294-5213	500
○ N'-PE-L'	294-5223	500
○ 1-PE-N	294-5253	500

Dimensions in mm

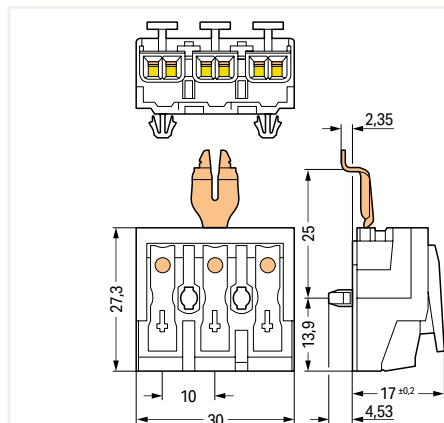

Field-wiring terminal block; with angled ground contact; with snap-in mounting feet; 3-pole; white

Marking	Item No.	Pack. Unit
○ N-PE-L	294-5313	500
○ N'-PE-L'	294-5323	500
○ 1-PE-N	294-5353	500

Field-wiring terminal block; with screw-type ground contact; without snap-in mounting feet; 3-pole; white

○ N-PE-L	294-4413	500
○ N'-PE-L'	294-4423	500
○ 1-PE-N	294-4453	500

Field-wiring terminal block; with snap-in ground contact; without snap-in mounting feet; 3-pole; white

○ N-PE-L	294-4213	500
○ N'-PE-L'	294-4223	500
○ 1-PE-N	294-4253	500

Field-wiring terminal block; with angled snap-in ground contact; without snap-in mounting feet; 3-pole; white

○ N-PE-L	294-4313	500
○ N'-PE-L'	294-4323	500
○ 1-PE-N	294-4353	500

PUSH-IN CAGE CLAMP® | **PUSH WIRE®**

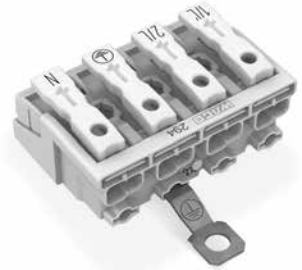
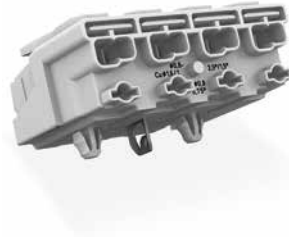
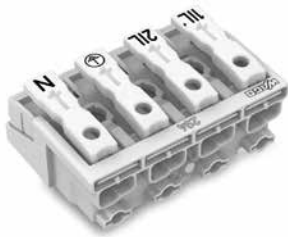

Dimensions in mm

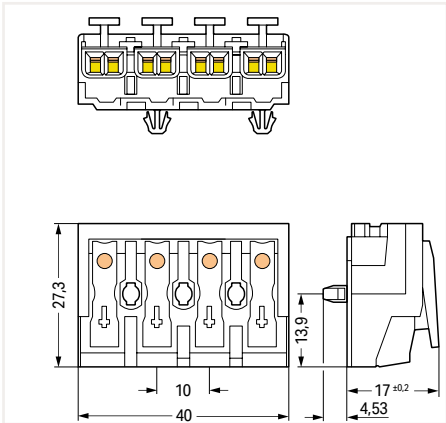

Field-wiring terminal block; without ground contact; with snap-in mounting feet; 4-pole; white

Marking	Item No.	Pack. Unit
○ 1/L'-2/L-PE-N	294-5024	500
○ 1-2-PE-N	294-5014	500
○ 4-3-2-1	294-5044	500
○ plain	294-5004	500
○ 1/L'-2/L-E-N	294-5094/4025-000	500

Field-wiring terminal block; without ground contact; without snap-in mounting feet; 4-pole; white

○ 1/L'-2/L-PE-N	294-4024	500
○ 1-2-PE-N	294-4014	500
○ 4-3-2-1	294-4044	500
○ plain	294-4004	500
○ 1/L'-2/L-E-N	294-4094/4025-000	500

Dimensions in mm

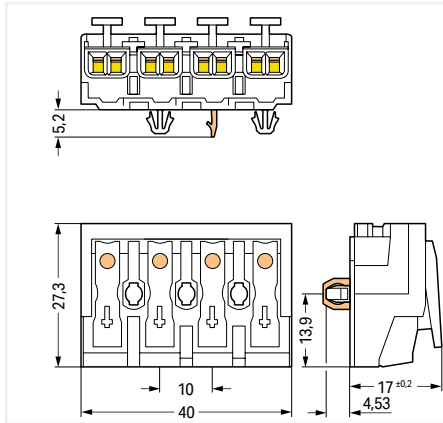

Field-wiring terminal block; with direct ground contact; with snap-in mounting feet; 4-pole; white

Marking	Item No.	Pack. Unit
○ 1/L'-2/L-PE-N	294-5124	500
○ 1-2-PE-N	294-5114	500

Dimensions in mm

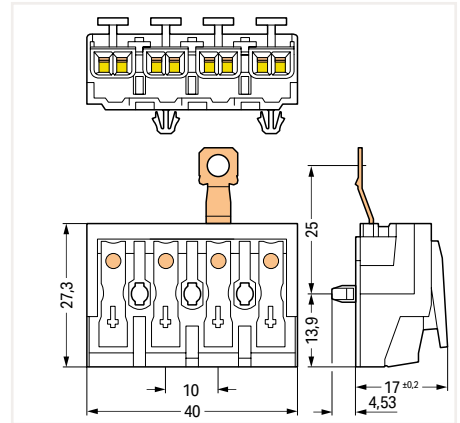

Field-wiring terminal block; with screw-type ground contact; with snap-in mounting feet; 4-pole; white

Marking	Item No.	Pack. Unit
○ 1/L'-2/L-PE-N	294-5424	500
○ 1-2-PE-N	294-5414	500

Field-wiring terminal block; with screw-type ground contact; without snap-in mounting feet; 4-pole; white

○ 1/L'-2/L-PE-N	294-4424	500
○ 1-2-PE-N	294-4414	500

Field-Wiring Terminal Block

2.5 mm; 294 Series

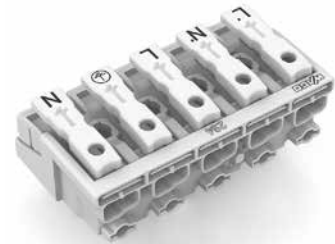
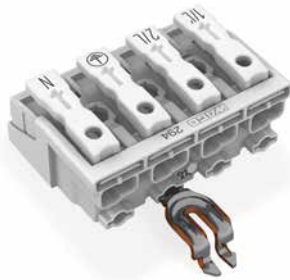
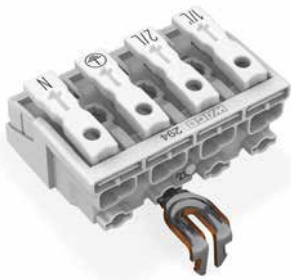

Dimensions in mm

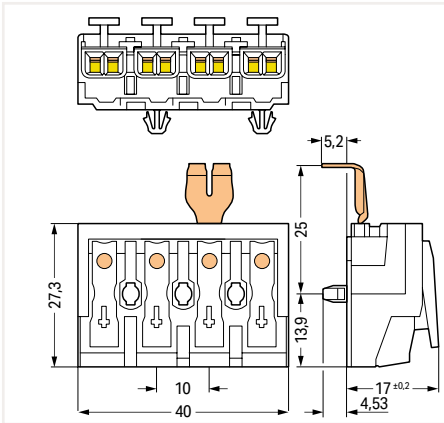

Field-wiring terminal block; with ground contact; with snap-in mounting feet; 4-pole; white

Marking	Item No.	Pack. Unit
○ 1/L'-2/L-PE-N	294-5224	500
○ 1-2-PE-N	294-5214	500

Dimensions in mm

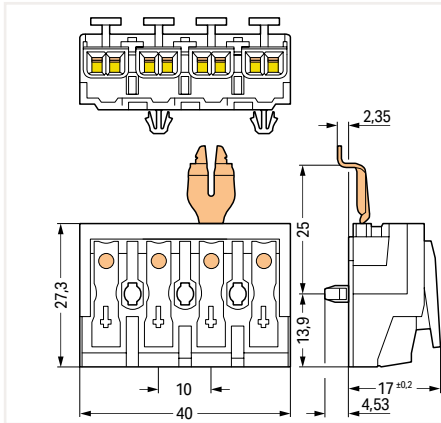

Field-wiring terminal block; with angled ground contact; with snap-in mounting feet; 4-pole; white

Marking	Item No.	Pack. Unit
○ 1/L'-2/L-PE-N	294-5324	500
○ 1-2-PE-N	294-5314	500

Dimensions in mm

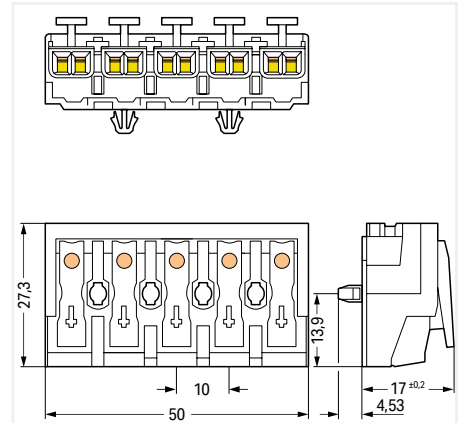

Field-wiring terminal block; without ground contact; with snap-in mounting feet; 5-pole; white

Marking	Item No.	Pack. Unit
○ L'-N'-L-PE-N	294-5025	250
○ L3-L2-L1-PE-N	294-5015	250
○ DA+ DA- L PE N	294-5035	250
○ DA- N PE L DA+	294-5075	250
○ 3-N-PE-1-2	294-5055	250
○ 5-4-3-2-1	294-5045	250
○ plain	294-5005	250
○ DA+ DA- L E N	294-5095/5025-000	250
○ L3-L2-L1-E-N	294-5095/5026-000	250
○ L'-N'-L-E-N	294-5095/5027-000	250

10

Field-wiring terminal block; with snap-in ground contact; without snap-in mounting feet; 4-pole; white

○ 1/L'-2/L-PE-N	294-4224	500
○ 1-2-PE-N	294-4214	500

Field-wiring terminal block; with angled snap-in ground contact; without snap-in mounting feet; 4-pole; white

○ 1/L'-2/L-PE-N	294-4324	500
○ 1-2-PE-N	294-4314	500

Field-wiring terminal block; without ground contact; without snap-in mounting feet; 5-pole; white

○ L'-N'-L-PE-N	294-4025	250
○ L3-L2-L1-PE-N	294-4015	250
○ DA+ DA- L PE N	294-4035	250
○ DA- N PE L DA+	294-4075	250
○ 3-N-PE-1-2	294-4055	250
○ 5-4-3-2-1	294-4045	250
○ plain	294-4005	250
○ DA+ DA- L E N	294-4095/5025-000	250
○ L3-L2-L1-E-N	294-4095/5026-000	250
○ L'-N'-L-E-N	294-4095/5027-000	250

PUSH-IN CAGE CLAMP® | **PUSH WIRE®**

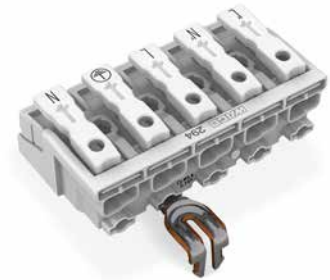
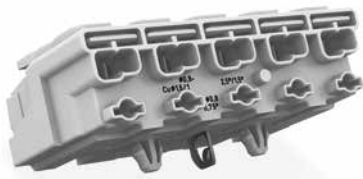

Dimensions in mm

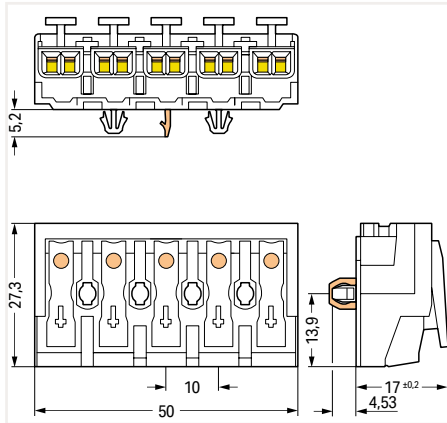

Field-wiring terminal block; with direct ground contact; with snap-in mounting feet; 5-pole; white

Marking	Item No.	Pack. Unit
○ DA- N PE L DA+	294-5175	250
○ 3-N-PE-1-2	294-5155	250

Dimensions in mm

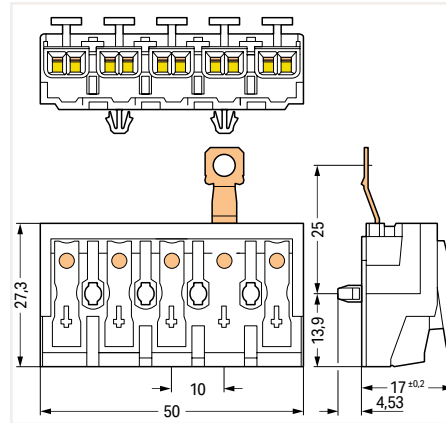

Field-wiring terminal block; with screw-type ground contact; with snap-in mounting feet; 5-pole; white

Marking	Item No.	Pack. Unit
○ L'-N'-L-PE-N	294-5425	250
○ L3-L2-L1-PE-N	294-5415	250
○ DA+ DA- L PE N	294-5435	250
○ DA- N PE L DA+	294-5475	250
○ 3-N-PE-1-2	294-5455	250

Dimensions in mm

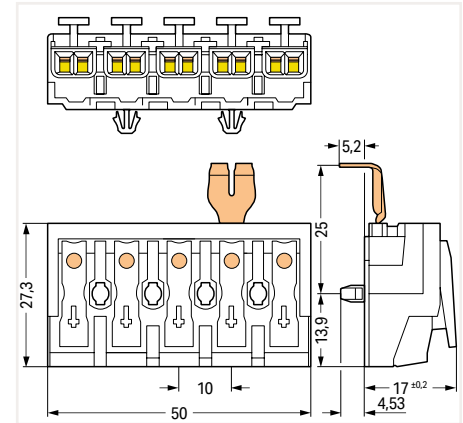

Field-wiring terminal block; with ground contact; with snap-in mounting feet; 5-pole; white

Marking	Item No.	Pack. Unit
○ L'-N'-L-PE-N	294-5225	250
○ L3-L2-L1-PE-N	294-5215	250
○ DA+ DA- L PE N	294-5235	250
○ DA- N PE L DA+	294-5275	250
○ 3-N-PE-1-2	294-5255	250

Field-wiring terminal block; with screw-type ground contact; without snap-in mounting feet; 5-pole; white

○ L'-N'-L-PE-N	294-4425	250
○ L3-L2-L1-PE-N	294-4415	250
○ DA+ DA- L PE N	294-4435	250
○ DA- N PE L DA+	294-4475	250
○ 3-N-PE-1-2	294-4455	250

Field-wiring terminal block; with snap-in ground contact; without snap-in mounting feet; 5-pole; white

○ L'-N'-L-PE-N	294-4225	250
○ L3-L2-L1-PE-N	294-4215	250
○ DA+ DA- L PE N	294-4235	250
○ DA- N PE L DA+	294-4275	250
○ 3-N-PE-1-2	294-4255	250

Field-Wiring Terminal Block

2.5 mm; 294 Series

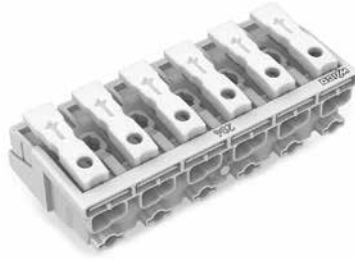
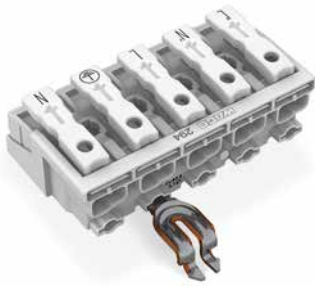

Dimensions in mm

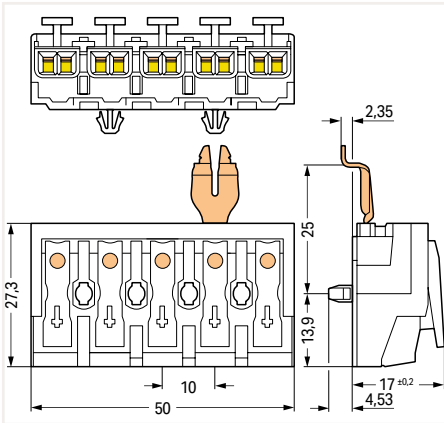

Field-wiring terminal block; without ground contact; with snap-in mounting feet; 5-pole; white

Marking	Item No.	Pack. Unit
○ L'-N'-L-PE-N	294-5325	250
○ L3-L2-L1-PE-N	294-5315	250
○ DA+ DA- L PE N	294-5335	250
○ DA- N PE L DA+	294-5375	250
○ 3-N-PE-1-2	294-5355	250

Dimensions in mm

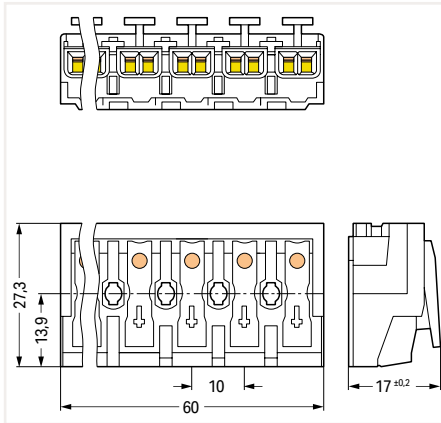

Field-wiring terminal block; without ground contact; without snap-in mounting feet; 6-pole; white

Marking	Item No.	Pack. Unit
○ plain	294-4006	200

Dimensions in mm

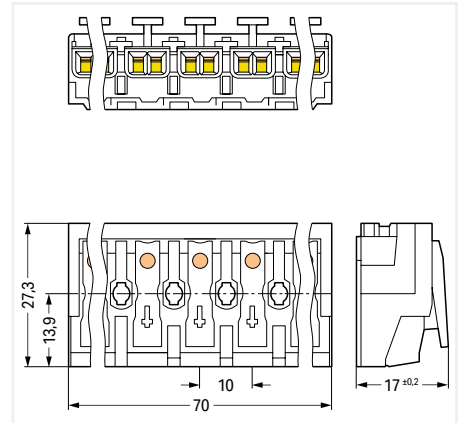

Field-wiring terminal block; without ground contact; without snap-in mounting feet; 7-pole; white

Marking	Item No.	Pack. Unit
○ plain	294-4007	200

Field-wiring terminal block; without ground contact; without snap-in mounting feet; 5-pole; white

Marking	Item No.	Pack. Unit
○ L'-N'-L-PE-N	294-4325	250
○ L3-L2-L1-PE-N	294-4315	250
○ DA+ DA- L PE N	294-4335	250
○ DA- N PE L DA+	294-4375	250
○ 3-N-PE-1-2	294-4355	250

10

Tool and Strain Relief Plate

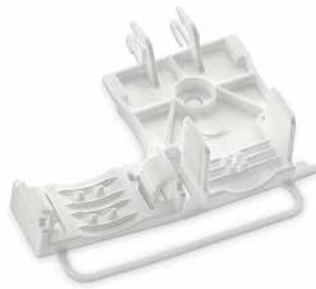

Dimensions in mm

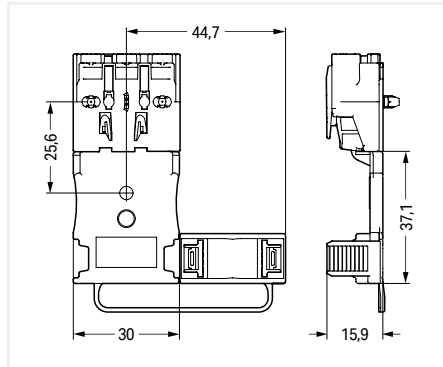

Dimensions in mm

Assembly tool; presses snap-in mounting feet into the mounting plate; fits ground connections safely and easily

	Item No.	Pack. Unit
	294-199	50

Strain relief plate; with locking clip; for multicore cable: 1 x 5.2 ... 12 mm outer diameter

Marking	Item No.	Pack. Unit
○ white	294-364	50

Strain relief; with snap-in mounting feet; for 4.5 ... 12 mm cable diameter

Marking	Item No.	Pack. Unit
○ white	294-370	500

Strain relief plate; with locking clip; for flat cables and individual conductors: min. 3 x 0.5 mm², max. 5 x 2.5 mm² or 7 x 1.5 mm²

○ white	294-384	50
---------	---------	----



Disconnection tool; removes conductors from PUSH WIRE® connections

	Item No.	Pack. Unit
	206-294	1



Conductor removal:
Slide disconnection tool beneath the conductor and pull both conductor and tool out.



Strain relief; for screw/rivet mounting; for 4.5 ... 12 mm cable diameter

○ white	294-375	500
---------	---------	-----



Strain relief; for screw/rivet mounting; for 4.5 ... 12 mm cable diameter

Drilled-Hole Patterns for Snap-In Mounting Feet 294 Series

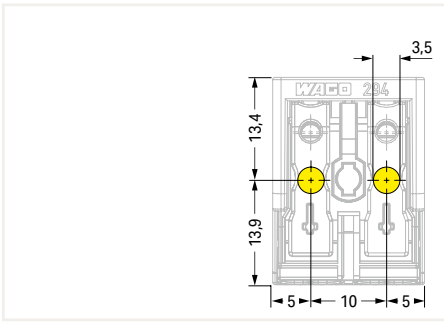

2-pole – without ground contact

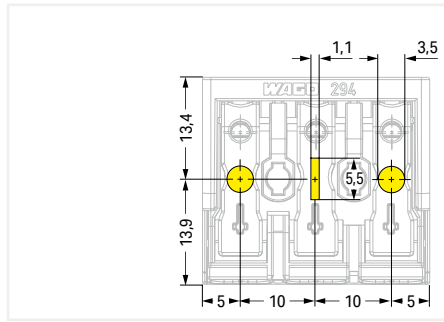

3-pole – with direct ground contact

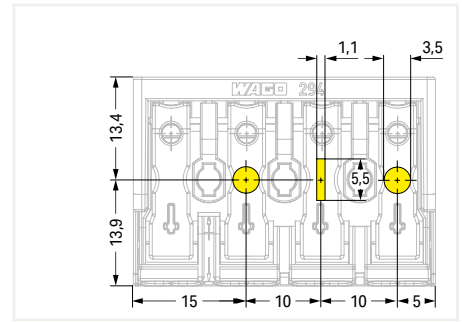

3-pole – with direct ground contact

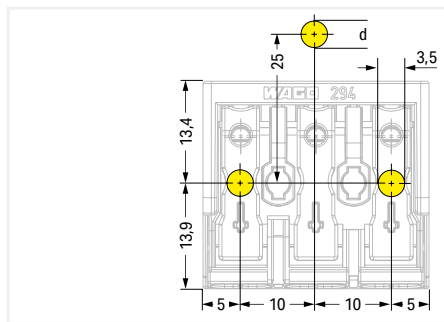

3-pole –
with snap-in ground contact, $d = 4.9 \text{ mm}$
with screw-type ground contact, $d \leq 4.1 \text{ mm}$

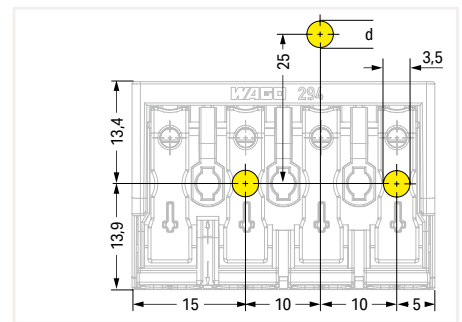

4-pole –
with snap-in ground contact, $d = 4.9 \text{ mm}$
with screw-type ground contact, $d \leq 4.1 \text{ mm}$

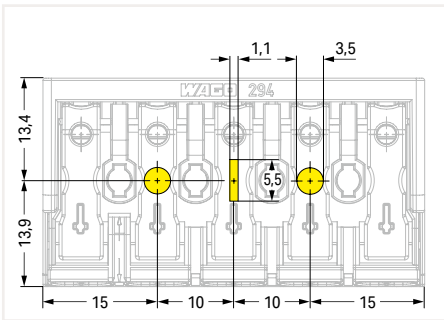

3-pole – with direct ground contact

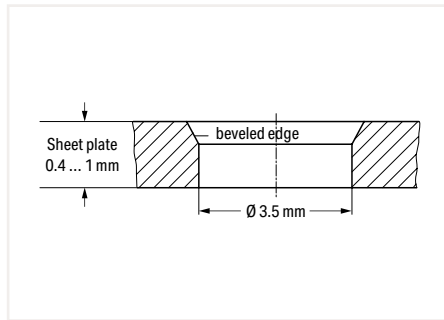

Drilled hole for snap-in mounting foot

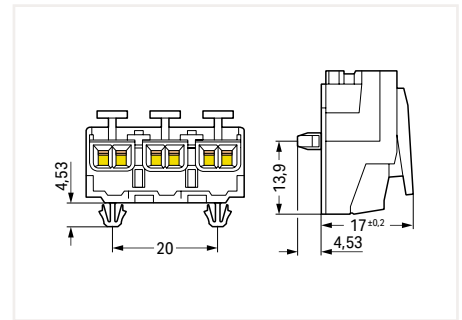

Snap-in mounting foot

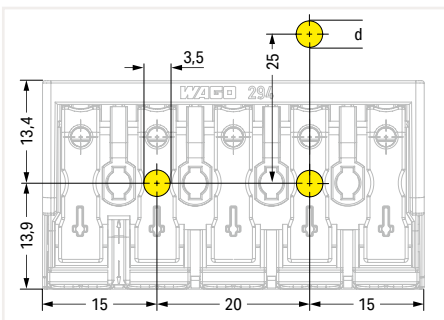

5-pole –
with snap-in ground contact, $d = 4.9 \text{ mm}$
with screw-type ground contact, $d \leq 4.1 \text{ mm}$

10

Drilled-Hole Patterns for Screw Mounting 294 Series

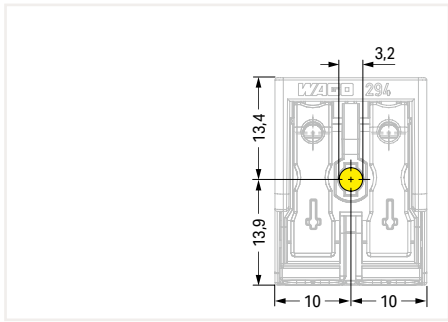

2-pole – without ground contact

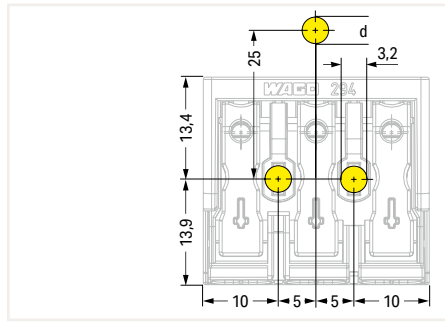

3-pole –
with snap-in ground contact, $d = 4.9$ mm
with screw-type ground contact, $d \leq 4.1$ mm

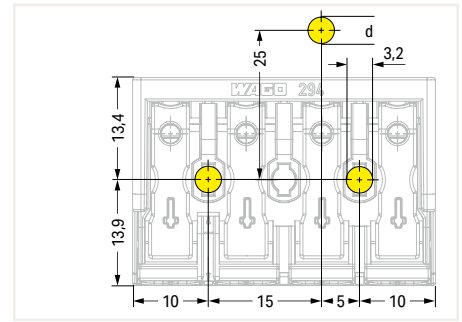

4-pole –
with snap-in ground contact, $d = 4.9$ mm
with screw-type ground contact, $d \leq 4.1$ mm

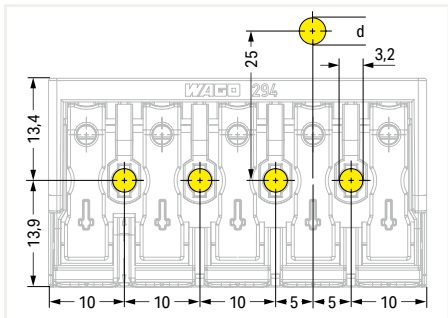

5-pole –
with snap-in ground contact, $d = 4.9$ mm
with screw-type ground contact, $d \leq 4.1$ mm

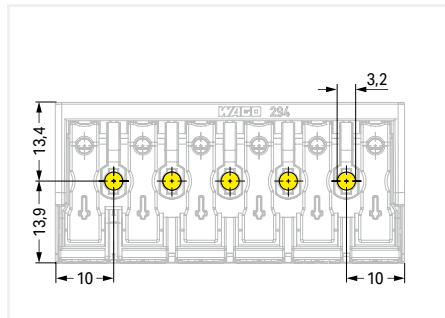

6-pole – without ground contact

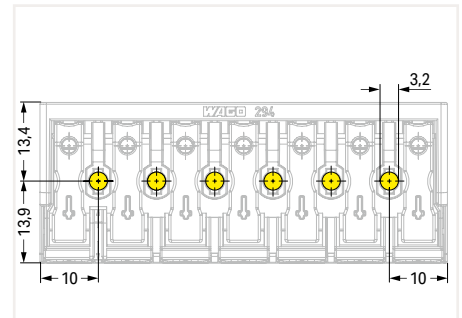

7-pole – without ground contact

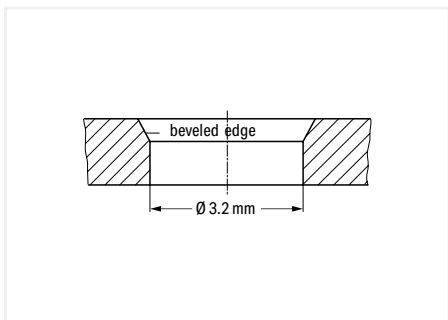

Hole for screw mount
Notice:
The maximum thread diameter for self-tapping screws is 3 mm.

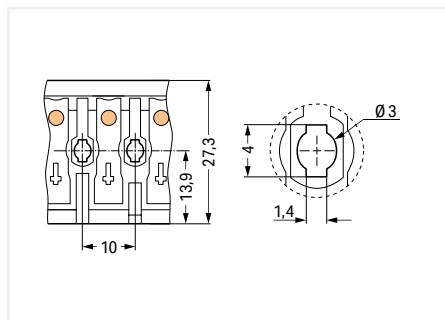

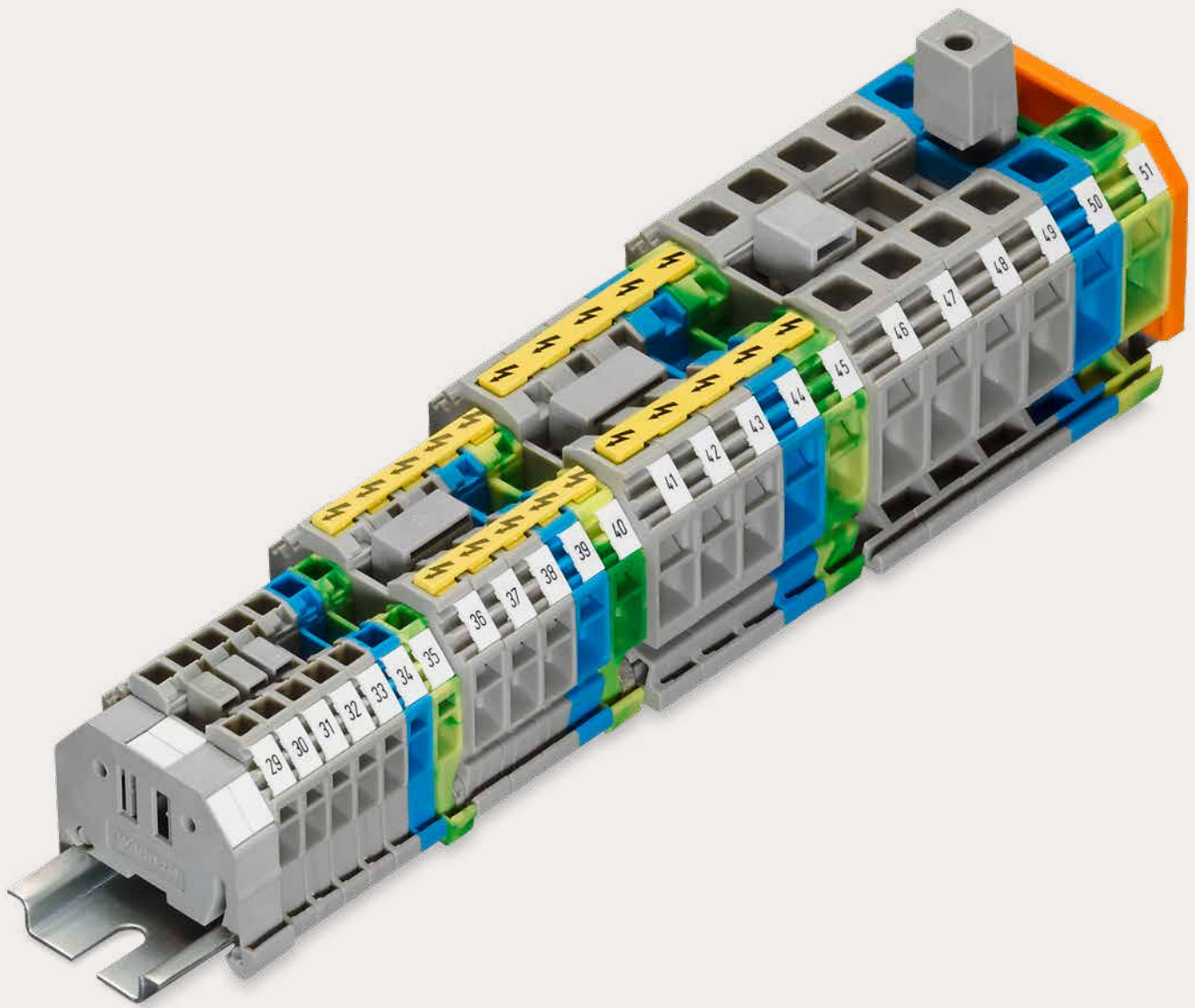

Mounting hole for screw
Notice:
The maximum thread diameter for self-tapping screws is 3 mm.



WAGO Rail-Mount Terminal Blocks Classic

WAGO Rail-Mount Terminal Blocks Classic

Side-Entry Wiring

			Page
	Through and Ground Conductor Terminal Blocks 0.08 ... 16 mm ² (28 ... 6 AWG)	279 ... 283 Series	538
	Disconnect/Test Terminal Blocks and Ground Conductor Disconnect Terminal Blocks 0.2 ... 6 mm ² (24 ... 10 AWG)	282 Series	542
	Fuse Terminal Blocks 0.2 ... 6 mm ² (24 ... 10 AWG)	282 Series	544

Rail-Mount Terminal Blocks Classic; Side-Entry Wiring

279 ... 284 Series

Description and Installation

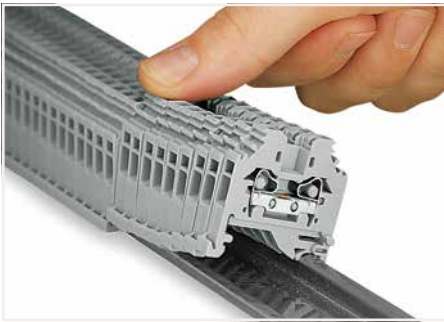

Snapping side-entry rail-mount terminal blocks onto the DIN-rail.

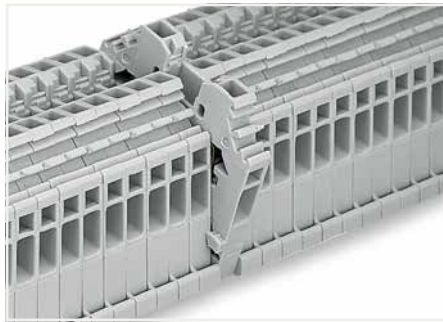

Quick assembly keys prevent reverse mounting.

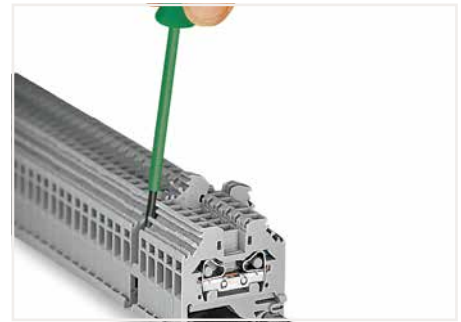

Removing a terminal block from the assembly.

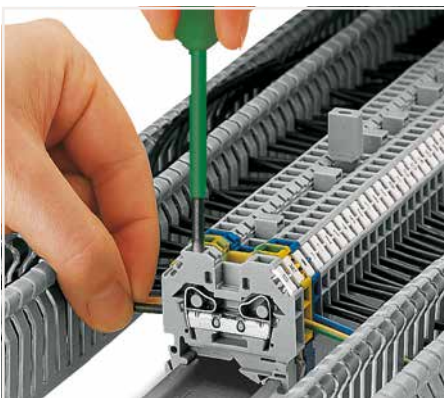

CAGE CLAMP® connection
Inserting a conductor.
With ferruled conductors, it is necessary to use a terminal block one size larger than the conductor's nominal cross section.

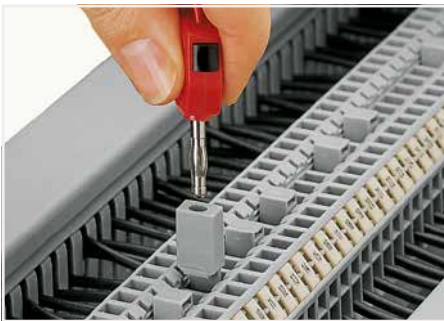
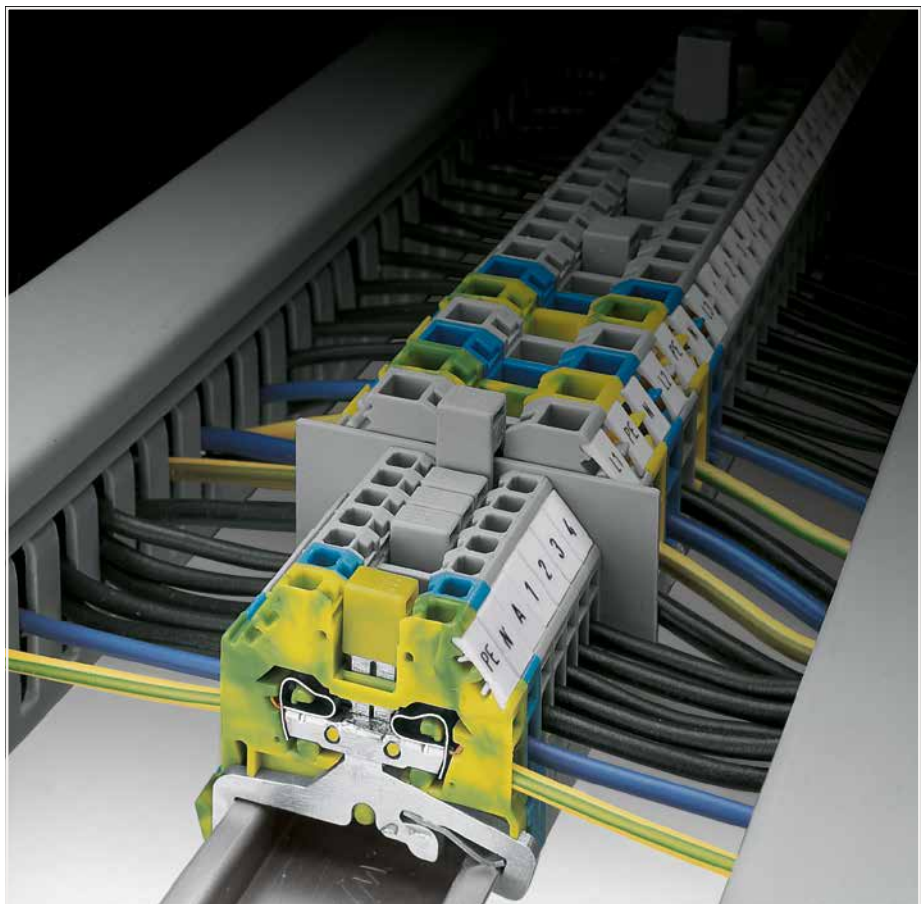

Testing with a test plug –
Picture shows a test plug adapter (209-170).



Commoning using an adjacent jumper (280-402).
Push jumpers down until fully inserted.



Commoning side-entry rail-mount terminal blocks via step-down jumpers.
Push down the step-down jumper until fully inserted.



CAGE CLAMP® terminates the following copper conductors: solid "s"



stranded "st"



fine-stranded "f-st", also with tinned single strands



Suitable for all DIN-35 rails

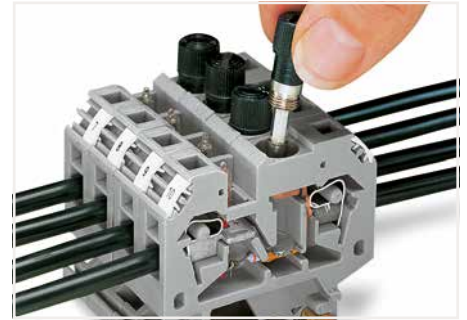

Replacing a fuse.

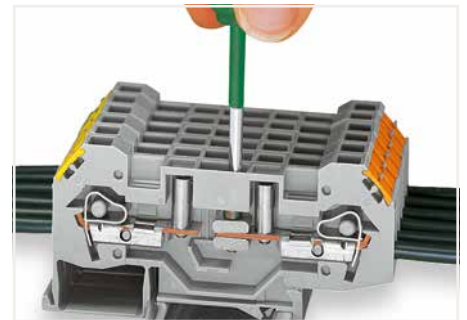
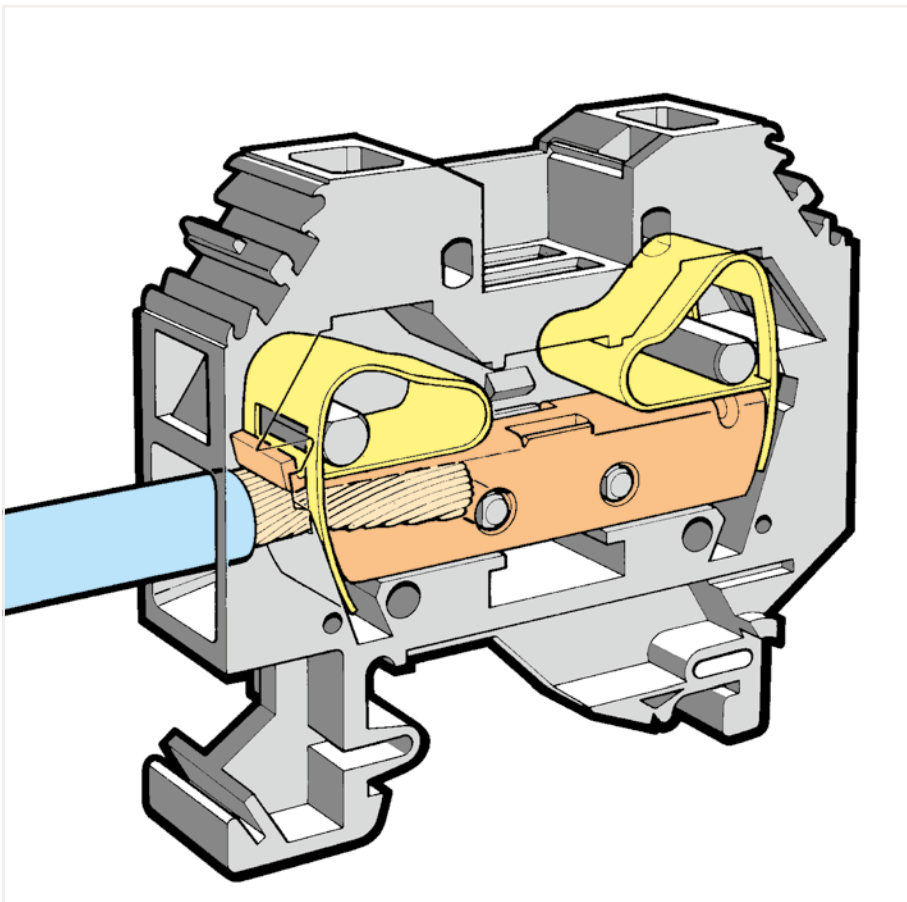

Shifting the disconnect slide link of a disconnect/test terminal block.

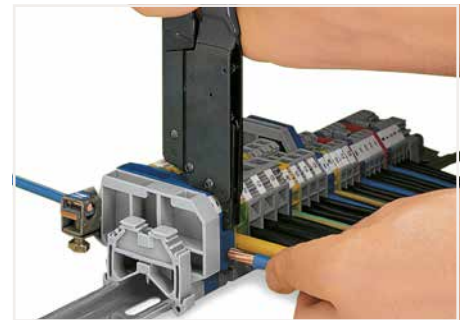

When operating the handles beyond the locked position, the ratchet allows the tool to open and be removed from the terminal block.



Labeling via WMB Multi Marking System.



fine-stranded, tip-bonded



fine-stranded, with ferrule (gastight crimped)



fine-stranded, with pin terminal (gastight crimped)

Through and Ground Conductor Terminal Block

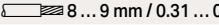

1.5 mm²; 279 Series and 2.5 mm²; 280 Series and 4 mm²; 281 Series and 6 mm²; 282 Series

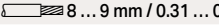

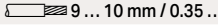
Technical Data	
0.08 ... 1.5 mm ²	28 ... 16 AWG
800 V/8 kV/3 ①	600 V, 10 A ②
I _N 18 A	600 V, 15 A ③
Terminal block width: 4 mm / 0.157 inch	
 8 ... 9 mm / 0.31 ... 0.35 inch	

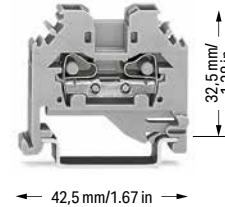
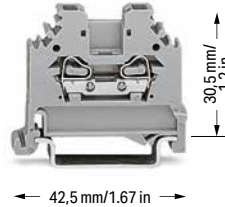
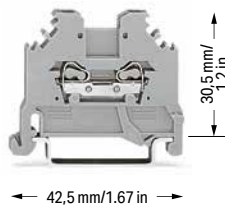

Technical Data	
0.08 ... 2.5 mm ²	28 ... 12 AWG*
800 V/8 kV/3 ①	600 V, 20 A ②
I _N 24 A	600 V, 20 A ③
Terminal block width: 5 mm / 0.197 inch	
 8 ... 9 mm / 0.31 ... 0.35 inch	

Technical Data	
0.08 ... 4 mm ²	28 ... 12 AWG
800 V/8 kV/3 ①	600 V, 20 A ②
I _N 32 A	600 V, 25 A ③
Terminal block width: 6 mm / 0.236 inch	
 9 ... 10 mm / 0.35 ... 0.39 inch	





2-conductor through terminal block		
Color	Item No.	Pack. Unit
 gray	279-101	100
 blue	279-104 ②	100



2-conductor through terminal block		
Color	Item No.	Pack. Unit
 gray	280-101	100
 blue	280-104 ②	100



2-conductor through terminal block		
Color	Item No.	Pack. Unit
 gray	281-101	100
 blue	281-104 ②	100



2-conductor ground terminal block		
Color	Item No.	Pack. Unit
 green-yellow	280-107	100



2-conductor ground terminal block		
Color	Item No.	Pack. Unit
 green-yellow	281-107	100



Accessories; item-specific			
End and intermediate plate; 2.5 mm thick			
	orange	280-302	100 (25)
	gray	280-301	100 (25)



Accessories; item-specific			
End and intermediate plate; 2.5 mm thick			
	orange	280-302	100 (25)
	gray	280-301	100 (25)



Accessories; item-specific			
End and intermediate plate; 3 mm thick			
	orange	281-302	100 (25)
	gray	281-301	100 (25)



Separator; oversized; 2 mm thick			
	orange	280-322	100 (25)
	gray	280-332	100 (25)

Separator; oversized; 2 mm thick			
	orange	280-322	100 (25)
	gray	280-332	100 (25)

Separator; oversized; 2 mm thick			
	orange	281-322	100 (25)
	gray	281-332	100 (25)

Adjacent jumper; insulated; I _N 15 A			
	gray	279-402	200 (25)
	yellow-green	279-422	200 (25)

Adjacent jumper; insulated; I _N = I _N terminal block			
	gray	280-402	200 (25)
	yellow-green	280-422	200 (25)

Adjacent jumper; insulated; I _N = I _N terminal block			
	gray	281-402	200 (25)
	yellow-green	281-422	200 (25)

Alternate jumper; insulated; I _N 15 A			
	gray	279-409	100 (25)

Alternate jumper; insulated; I _N = I _N terminal block			
	gray	280-409	100 (25)

Alternate jumper; insulated; I _N = I _N terminal block			
	gray	281-409	100 (25)

Step-down jumper; insulated; commons 10/6 mm ² (8/10 AWG) down to 4/2.5/1.5 mm ² (12/14/16 AWG); I _N 15 A			
	gray	284-414	50 (25)

Step-down jumper; insulated; commons 10/6 mm ² (8/10 AWG) down to 4/2.5/1.5 mm ² (12/14/16 AWG); I _N 15 A			
	gray	284-414	50 (25)

Step-down jumper; insulated; commons 10/6 mm ² (8/10 AWG) down to 4/2.5/1.5 mm ² (12/14/16 AWG); I _N 15 A			
	gray	284-414	50 (25)

Step-down intermediate plate; 1 mm thick; only for 4, 2.5 and 1.5 mm ² terminal blocks			
	gray	281-333	100 (25)

Step-down intermediate plate; 1 mm thick; only for 4, 2.5 and 1.5 mm ² terminal blocks			
	gray	281-333	100 (25)

Step-down intermediate plate; 1 mm thick; only for 4, 2.5 and 1.5 mm ² terminal blocks			
	gray	281-333	100 (25)

Protective warning marker; with black high-voltage symbol; for 5 terminal blocks			
	yellow	279-405	100 (25)

Protective warning marker; with black high-voltage symbol; for 5 terminal blocks			
	yellow	280-405	100 (25)

Step-down jumper; insulated; commons 10/6 mm ² (8/10 AWG) down to 6/4 mm ² (10/12 AWG); I _N 30 A			
	gray	284-413	50 (25)

Test plug adapter; 8.3 mm wide; for 4 mm Ø test plug; for 1.5 ... 10 mm ² terminal blocks			
	gray	209-170	50 (25)

Test plug adapter; 8.3 mm wide; for 4 mm Ø test plug; for 1.5 ... 10 mm ² terminal blocks			
	gray	209-170	50 (25)

Step-down jumper; insulated; commons 16 mm ² (6 AWG) down to 4 mm ² (12 AWG); I _N 32 A			
	gray	283-414	50 (25)

Test plug adapter; 5 mm wide; for 210-137 Test Plug (2.3 mm Ø); for 1.5 ... 4 mm ² terminal blocks			
	gray	280-404	100 (25)

Test plug adapter; 5 mm wide; for 210-137 Test Plug (2.3 mm Ø); for 1.5 ... 4 mm ² terminal blocks			
	gray	280-404	100 (25)

Protective warning marker; with black high-voltage symbol; for 5 terminal blocks			
	yellow	281-405	100 (25)

11

Technical Data

0.2 ... 6 mm ²	24 ... 10 AWG
800 V/8 kW/3 ①	600 V, 30 A ②
I _N 41 A	600 V, 10 A ③
Terminal block width: 8 mm / 0.315 inch	
12 ... 13 mm / 0.47 ... 0.51 inch	

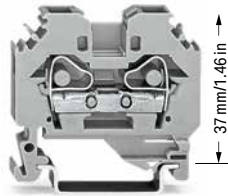

← 46,5 mm/1.83 in →

2-conductor through terminal block



Color	Item No.	Pack. Unit
gray	282-101	50
blue	282-104 ②	50

2-conductor ground terminal block



green-yellow	282-107	50
--------------	---------	----

Accessories; item-specific

End and intermediate plate; 4 mm thick

	orange	282-302	100 (25)
	gray	282-301	100 (25)

Separator; oversized; 2 mm thick

	orange	282-322	100 (25)
	gray	282-332	100 (25)

Adjacent jumper; insulated; I_N 41 A

	gray	282-402	100 (25)
	yellow-green	282-422	100 (25)



Alternate jumper; insulated; I_N 41 A

	gray	282-409	100 (25)
---	------	---------	----------

Step-down jumper; insulated; commons 10/6 mm² (8/10 AWG) down to 6/4 mm² (10/12 AWG); I_N 30 A

	gray	284-413	50 (25)
---	------	---------	---------

Step-down cover plate; 1 mm thick

	gray	284-333	100 (25)
	orange	284-343	100 (25)

Protective warning marker; with black high-voltage symbol; for 5 terminal blocks

	yellow	282-405	100 (25)
---	--------	---------	----------

Test plug adapter; 8.3 mm wide; for 4 mm Ø test plug; for 1.5 ... 10 mm² terminal blocks

	gray	209-170	50 (25)
---	------	---------	---------

B-type test plug module; snaps together; 8 mm wide

	gray	709-310	100 (25)
---	------	---------	----------

*12 AWG: THHN, THWN

- 800 V = rated voltage
8 kV = rated impulse voltage
3 = pollution degree
(see Section 15)

- Terminal blocks with a blue insulated housing are suitable for Ex i applications.

See application notes for:
Step-down jumper, page 541
Test plug module, page 381
Marking, from page 640

Approvals and corresponding ratings,
visit www.wago.com

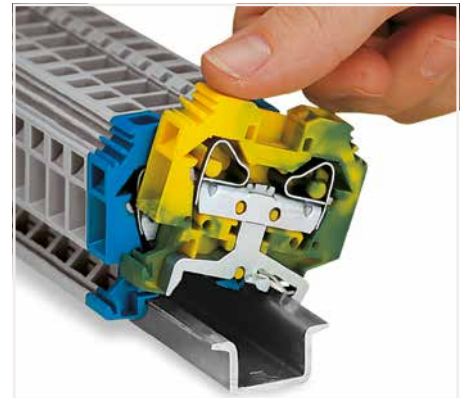

Snapping a terminal block onto the DIN-rail. Ground conductor terminal blocks snap onto the rail in the same way as through terminal blocks, but automatically make a direct electrical connection to the rail. After mounting, sliding the blocks on the rail is not possible.

DIN-Rail	Item No.	Current [A]	Acc. to mm ² /AWG Cu
DIN 35 x 7.5 (steel)			
slotted	210-112	76	16/6
unslotted	210-113	76	16/6
DIN 35 x 15 (steel)			
1.5 mm thick	210-114	125	35/2
2.3 mm thick	210-118	125	35/2
DIN 35 x 7.5 (Al)			
unslotted	210-196	76	16/6
DIN 35 x 15 (Cu)			
2.3 mm thick	210-198	309	150/6/0
Current applies to rails of 1 m/3'3" length			

When using standard DIN-rails as ground conductor bus-bars, please refer to the maximum current capacities listed above.

Steel DIN-rails are not suited for PEN (ground and N-conductor) applications per EN 60947-7-2 (VDE 0611, Part 3).

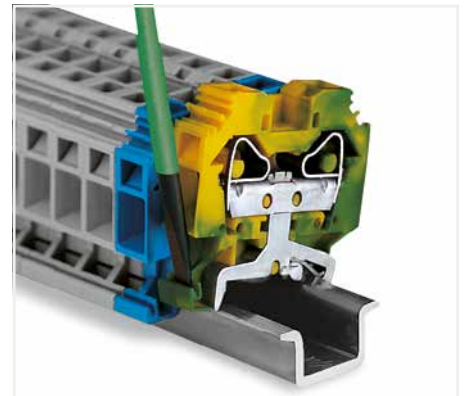

Removing a terminal block from the DIN-rail. When mounting on the rail, ensure that open sides of terminal blocks face in the same direction. Both mounting feet and removal slots are on the same side for all terminal blocks, making it possible to visually ensure blocks are facing in same direction.

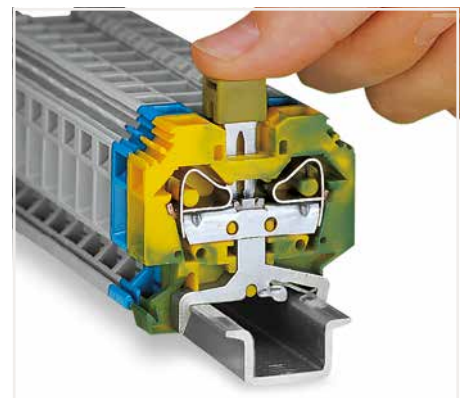

Push jumper down until fully inserted. Commoning ground conductor terminal blocks with through terminal blocks is possible in one direction only (via rear side of terminal block) using adjacent jumpers. Recommends using yellow-green adjacent jumpers in addition to the required marking of these blocks.

Through and Ground Conductor Terminal Block

10 mm²; 284 Series and 16 mm²; 283 Series

Technical Data

0.2 ... 10 mm ²	24 ... 8 AWG
800 V/8 kV/3 ①	600 V, 50 A ②
I _N 57 A	600 V, 65 A ③
Terminal block width: 10 mm / 0.394 inch	
12 ... 13 mm / 0.47 ... 0.51 inch	

Technical Data

0.2 ... 16 mm ²	24 ... 6 AWG
800 V/8 kV/3 ①	600 V, 65 A ②
I _N 76 A	600 V, 90 A ③
Terminal block width: 12 mm / 0.472 inch	
16 ... 17 mm / 0.63 ... 0.67 inch	

- ① 800 V = rated voltage
- ② 8 kV = rated impulse voltage
- ③ 3 = pollution degree (see Section 15)

See application notes for:
Step-down jumper, page 541
Test plug module, page 381
Marking, from page 640

Approvals and corresponding ratings, visit www.wago.com

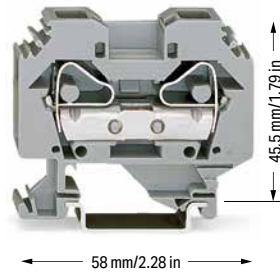
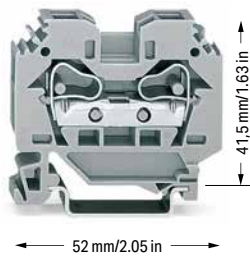

2-conductor through terminal block

Color	Item No.	Pack. Unit
gray	284-101	50
blue	284-104 ②	50

2-conductor through terminal block

Color	Item No.	Pack. Unit
gray	283-101	50
blue	283-104 ②	50

2-conductor ground terminal block

green-yellow	284-107	50
--------------	---------	----

2-conductor ground terminal block

green-yellow	283-107	50
--------------	---------	----

Accessories; item-specific

End and intermediate plate; 2.5 mm thick

orange	284-302	100 (25)
gray	284-301	100 (25)

Accessories; item-specific

End and intermediate plate; 4 mm thick

orange	283-302	50 (25)
gray	283-301	50 (25)

Separator; oversized; 2 mm thick

orange	284-322	100 (25)
gray	284-332	100 (25)

Separator; oversized; 2 mm thick

orange	283-322	50 (25)
gray	283-332	50 (25)

Adjacent jumper; insulated; I_N 57 A

gray	284-402	100 (25)
yellow-green	284-422	100 (25)

Adjacent jumper; insulated; I_N 70 A

gray	283-402	50 (25)
yellow-green	283-422	50 (25)

Alternate jumper; insulated; I_N 57 A

gray	284-409	50 (25)
------	---------	---------

Alternate jumper; insulated; I_N 76 A

gray	283-409	50 (25)
------	---------	---------

Step-down jumper; insulated; commons 10/6 mm² (8/10 AWG) down to 6/4 mm² (10/12 AWG); I_N 30 A

gray	284-413	50 (25)
------	---------	---------

Step-down jumper; insulated; commons 16 mm² (6 AWG) down to 4 mm² (12 AWG); I_N 32 A

gray	283-414	50 (25)
------	---------	---------

Step-down cover plate; 1 mm thick

gray	284-333	100 (25)
orange	284-343	100 (25)

Step-down cover plate; 1 mm thick

gray	283-333	100 (25)
orange	283-335	100 (25)

Protective warning marker; with black high-voltage symbol; for 5 terminal blocks

yellow	284-405	50 (25)
--------	---------	---------

Protective warning marker; with black high-voltage symbol; for 5 terminal blocks

yellow	283-405	50 (25)
--------	---------	---------

Test plug adapter; 8.3 mm wide; for 4 mm Ø test plug; for 1.5 ... 10 mm² terminal blocks

gray	209-170	50 (25)
------	---------	---------

Test plug adapter; 8.3 mm wide; for 4 mm Ø test plug; for 1.5 ... 10 mm² terminal blocks

gray	283-404	25
------	---------	----

B-type test plug module; snaps together; 8 mm wide

gray	709-310	100 (25)
------	---------	----------



Step-down jumpers connect common terminal blocks of different sizes, without losing a conductor clamping point. This can be beneficial on long conductor runs where voltage drop can be a problem. A large conductor can be easily connected to smaller conductors at the distribution point.

Step-down jumpers are simply pushed down for full insertion, similar to adjacent jumpers. Commoning may be made in either direction using the special thin end plate to cover the open side. Additional through terminal blocks having a smaller cross-section may be commoned using adjacent jumpers.

In this case, pay attention that:
The total current of the outgoing circuits does not exceed the nominal current of the step-down jumper.
The standard or special thin cover plate is installed on the open side of the larger block.

11

Step-Down Jumper; for Side-Entry Through Terminal Blocks Installation



Side-entry terminal blocks cannot be commoned with front-entry terminal blocks via step-down jumpers. For commoning front-entry terminal blocks via step-down jumpers, see page 286.

Step-down jumper; insulated; commons 10/6 mm² (8/10 AWG) down to 4/2.5/1.5 mm² (12/14/16 AWG); I_N 15 A

Color	Item No.	Pack. Unit
○ gray	284-414	50 (25)

Step-down jumper; insulated; commons 10/6 mm² (8/10 AWG) down to 6/4 mm² (10/12 AWG); I_N 30 A

○ gray	284-413	50 (25)
--------	---------	---------

Accessories; item-specific

Step-down cover plate; 1 mm thick

gray	284-333	100 (25)
orange	284-343	100 (25)

Step-down intermediate plate; 1 mm thick; only for 4, 2.5 and 1.5 mm² terminal blocks

gray	281-333	100 (25)
------	---------	----------

Step-down jumper; insulated; commons 16 mm² (6 AWG) down to 4 mm² (12 AWG); I_N 32 A

Color	Item No.	Pack. Unit
○ gray	283-414	50 (25)

Accessories; item-specific

Step-down cover plate; 1 mm thick

gray	283-333	100 (25)
orange	283-335	100 (25)



Commoning from 6 mm²/10 AWG (282 Series) to 1.5 mm²/16 AWG (279 Series) rail-mount terminal blocks via step-down jumpers.

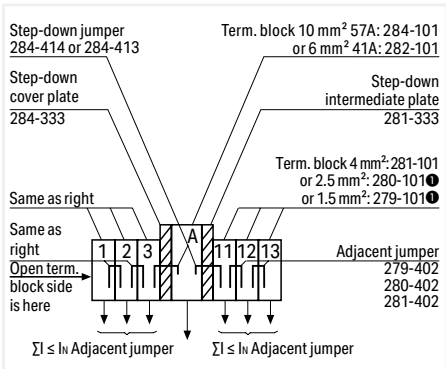

Assembly example: Commoning from 10/6 mm² (8/10 AWG) to 4/2.5/1.5 mm² (12/14/16 AWG) rail-mount terminal blocks via step-down jumper (284-414).
 ⚠ Commoning with step-down jumpers from 10 mm² (284-101) to 2.5 mm² (280-101) or 1.5 mm² (279-101) terminal blocks via the terminal block rear side is not possible (see example: terminal block A to 11).

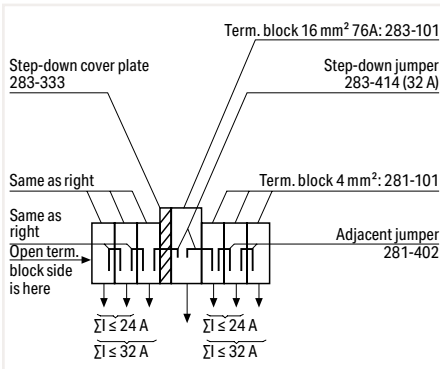

Assembly example: Commoning from 16 mm²/6 AWG to 4 mm²/12 AWG rail-mount terminal blocks via step-down jumper (283-414).



Commoning from 16 mm²/6 AWG (283 Series) to 4 mm²/12 AWG (281 Series) rail-mount terminal blocks via step-down jumpers.

Disconnect/Test Terminal Block

6 mm²; 282 Series

Technical Data	
0.2 ... 6 mm ²	24 ... 10 AWG
400 V/6 kV/3 ①	300 V, 30 A ②
I _N 41 A	300 V, 40 A ③
Terminal block width: 8 mm / 0.315 inch	
12 ... 13 mm / 0.47 ... 0.51 inch	

Technical Data	
0.2 ... 6 mm ²	24 ... 10 AWG
400 V/6 kV/3 ①	300 V, 30 A ②
I _N 41 A	300 V, 40 A ③
Terminal block width: 8 mm / 0.315 inch	
12 ... 13 mm / 0.47 ... 0.51 inch	

Technical Data	
0.2 ... 6 mm ²	24 ... 10 AWG
400 V/6 kV/3 ①	300 V, 30 A ②
I _N 41 A	300 V, 40 A ③
Terminal block width: 8 mm / 0.315 inch	
12 ... 13 mm / 0.47 ... 0.51 inch	

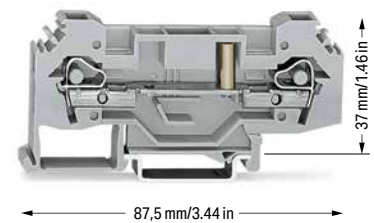
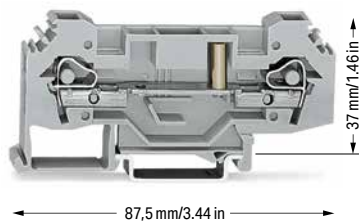
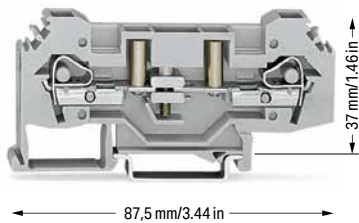



Disconnect/test terminal block; with 4 mm Ø test sockets		
Color	Item No.	Pack. Unit
○ gray	282-131	25

Through terminal block		
Color	Item No.	Pack. Unit
○ gray	282-133	25

Disconnect/test terminal block; without test sockets		
Color	Item No.	Pack. Unit
○ gray	282-135	25

Accessories; item-specific		
Alternate jumper; insulated; I _N 41 A		
	gray	282-409 100 (25)

Accessories; item-specific		
Alternate jumper; insulated; I _N 41 A		
	gray	282-409 100 (25)

Accessories; item-specific		
Alternate jumper; insulated; I _N 41 A		
	gray	282-409 100 (25)

Lock-out; prevents reclosing of slide link; snap-on type		
	orange	282-137 100 (25)

Test plug adapter; 8.3 mm wide; for 4 mm Ø test plug; for 1.5 ... 10 mm ² terminal blocks		
	gray	209-170 50 (25)

Lock-out; prevents reclosing of slide link; snap-on type		
	orange	282-137 100 (25)

Test plug adapter; 8.3 mm wide; for 4 mm Ø test plug; for 1.5 ... 10 mm ² terminal blocks		
	gray	209-170 50 (25)

B-type test plug module; snaps together; 8 mm wide		
	gray	709-310 100 (25)

Test plug adapter; 8.3 mm wide; for 4 mm Ø test plug; for 1.5 ... 10 mm ² terminal blocks		
	gray	209-170 50 (25)

B-type test plug module; snaps together; 8 mm wide		
	gray	709-310 100 (25)

B-type spacer module; snaps together; 8 mm wide		
	gray	709-311 100 (25)

B-type test plug module; snaps together; 8 mm wide		
	gray	709-310 100 (25)

B-type spacer module; snaps together; 8 mm wide		
	gray	709-311 100 (25)

B-type spacer module; snaps together; 8 mm wide		
	gray	709-311 100 (25)

Accessories; 282 Series

Appropriate marking system: WMB

End and intermediate plate; 4 mm thick		
	gray	282-315 50 (25)
	orange	282-314 50 (25)

Protective warning marker; with black high-voltage symbol; for 5 terminal blocks		
	yellow	282-405 100 (25)

Adjacent jumper; insulated; I _N 41 A		
	gray	282-402 100 (25)

Technical Data	
0.2 ... 6 mm ²	24 ... 10 AWG

Terminal block width: 16 mm / 0.63 inch

12 ... 13 mm / 0.47 ... 0.51 inch

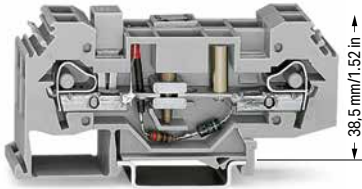

87,5 mm/3.44 in

Ground conductor disconnect terminal block; gray

Color	Item No.	Pack. Unit
○ 24 V	282-140	12
○ 48 V	282-141	12
○ 120 V	282-138	12
○ 230 V	282-139	12

Accessories; item-specific

Lock-out; prevents reclosing of slide link; snap-on type

	orange	282-137	100 (25)
--	--------	---------	----------

- 1 400 V = rated voltage
6 kV = rated impulse voltage
3 = pollution degree
(see Section 15)
- See application notes for:
Test plug module, page 381
Marking, from page 640
- Approvals and corresponding ratings,
visit www.wago.com

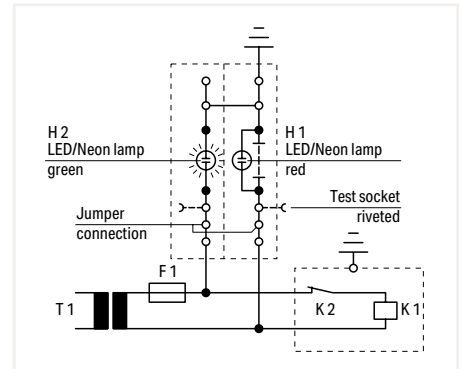

Operation
Slide link closed, auxiliary circuit grounded,
green LED/neon lamp illuminates.

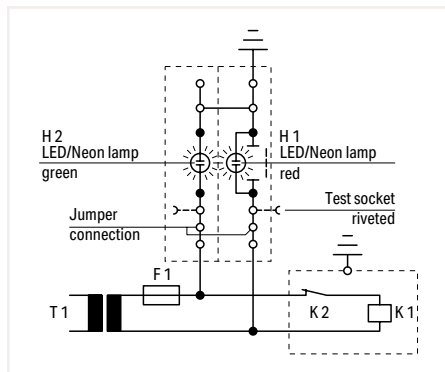

Test condition – no grounding
Slide link open, auxiliary circuit not grounded.

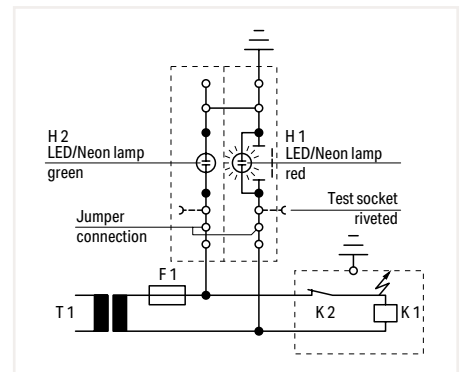

Test condition – grounding
Slide link open, auxiliary circuit not grounded,
red LED/neon lamp illuminates.

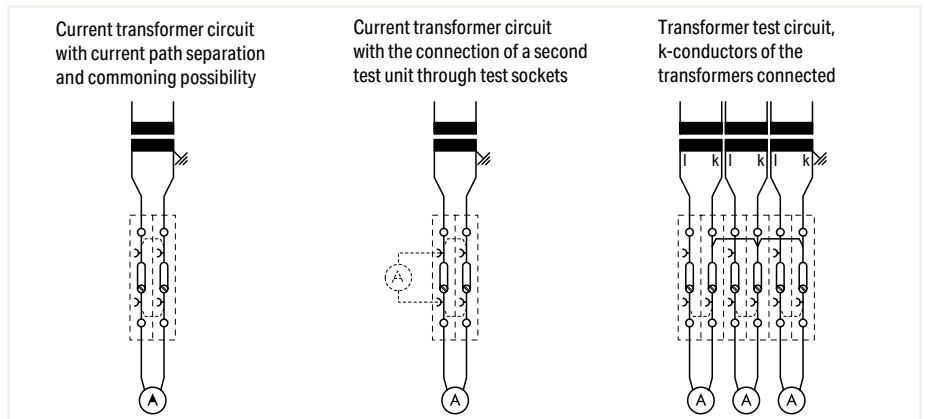

IEC 60204/DIN VDE 0113 "Safety of machinery – Electrical equipment of machines – Part 1: General requirements," Section 9.4.3.1:

Ground faults on control circuits must not cause unintentional starting, hazardous movements, or prevent stopping of the machine.

In order to fulfill this requirement, a connection to the protective bonding circuit must be provided in accordance with Section 8.2 and the devices must be connected as described in Section 9.1.4. Control circuits fed from a transformer and not connected to the protective bonding circuit must be provided with an insulation monitoring device (e.g., residual current device), which either indicates a ground fault or interrupts the circuit automatically after a ground fault. In the case of electronic circuits, the connection of one side of the control circuit to the protective bonding circuit in accordance with Section 9.1.4 can prevent unintentional operation. When this does not help, or if due to other reasons that electronic circuits cannot be connected to the protective bonding circuit, other measures must be taken to achieve the same level of safety.

Multipole control switches that interrupt all live conductors must be used where the control circuit is directly connected between the phase conductors of the supply or between a phase conductor and a neutral conductor, which is either not grounded or grounded through a high impedance. This is required for starting or stopping machine functions, which can cause a hazardous situation including: damaging the machine or halting work in progress in the event of unintentional starting or failure to stop.

Fuse Terminal Block

6 mm²; 282 Series

Technical Data	
0.2 ... 6 mm ²	24 ... 10 AWG
500 V/6 kV/3 ①	600 V, 10 A
I _N 10 A	250 V, 10 A
Terminal block width: 13 mm / 0.512 inch	
12 ... 13 mm / 0.47 ... 0.51 inch	

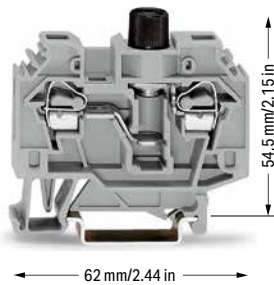

2-conductor fuse terminal block; for 5 x 20 mm miniature metric fuse; without blown fuse indication

Color	Item No.	Pack. Unit
gray	282-122	40

Technical Data	
0.2 ... 6 mm ²	24 ... 10 AWG
500 V/6 kV/3 ①	600 V, 10 A
I _N 10 A	250 V, 10 A
Terminal block width: 13 mm / 0.512 inch	
12 ... 13 mm / 0.47 ... 0.51 inch	



2-conductor fuse terminal block; for glass cartridge fuse 1/4" x 1 1/4"; without blown fuse indication

Color	Item No.	Pack. Unit
gray	282-120	40

2-conductor fuse terminal block; for glass cartridge fuse 1/4" x 1 1/4"; without blown fuse indication

gray	282-128	40
------	---------	----

Technical Data	
0.2 ... 6 mm ²	24 ... 10 AWG
500 V/6 kV/3 ①	600 V, 10 A
I _N 10 A	250 V, 10 A
Terminal block width: 13 mm / 0.512 inch	
12 ... 13 mm / 0.47 ... 0.51 inch	



2-conductor fuse terminal block; for 5 x 25 mm miniature metric fuse; without blown fuse indication

Color	Item No.	Pack. Unit
gray	282-126	40

Accessories; item-specific

Glass cartridge fuse; without indicator; 5 x 20 mm; 6.3 A / 250 V; medium-acting

	282-451	100
--	---------	-----

Accessories; item-specific

Glass cartridge fuse; without indicator; 1/4" x 1", 10 A / 240 V; per BS 1362

	282-458	200 (10)
--	---------	----------

Accessories; item-specific

Glass cartridge fuse; with indicator; 5 x 25 mm; 6.3 A / 250 V; medium-acting

	282-452	200 (10)
--	---------	----------

Glass cartridge fuse; without indicator; 1/4" x 1 1/4"; 10 A / 250 V; medium-acting

	282-457	200 (100)
--	---------	-----------

Glass cartridge fuse; with indicator; 5 x 25 mm, 10 A / 450 V; fast-acting

	282-453	200 (10)
--	---------	----------

Glass cartridge fuse; without indicator; 1/4" x 1 1/4"; very fast-acting

	282-454	200 (10)
--	---------	----------

Accessories; 282 Series

Appropriate marking system: WMB

End and intermediate plate; 4 mm thick

	orange	282-312	50 (25)
	gray	282-311	50 (25)

Test plug adapter; 6 mm wide; with CAGE CLAMP®; for 0.08 ... 2.5 mm²

	I _N 24 A	281-407	100 (25)
--	---------------------	---------	----------

Protective warning marker; with black high-voltage symbol; for 5 terminal blocks

	yellow	282-405	100 (25)
--	--------	---------	----------

Operating pliers; for 281, 282, 283, 284 Series side-entry rail-mounted terminal blocks

		210-141	1
--	--	---------	---

Adjacent jumper; insulated; I_N 41 A

	gray	282-402	100 (25)
--	------	---------	----------

Test plug adapter; 8.3 mm wide; for 4 mm Ø test plug; for 1.5 ... 10 mm² terminal blocks

	gray	209-170	50 (25)
--	------	---------	---------

Technical Data	
0.2 ... 6 mm ²	24 ... 10 AWG

Terminal block width: 13 mm / 0.512 inch
 12 ... 13 mm / 0.47 ... 0.51 inch

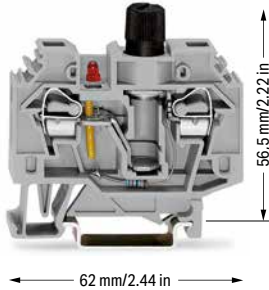

2-conductor fuse terminal block; for glass cartridge fuse ¼" x 1¼"; with 24 VDC red LED

Color	Item No.	Pack. Unit
○ gray	282-128/281-413	40

Technical Data	
0.2 ... 6 mm ²	24 ... 10 AWG

Terminal block width: 13 mm / 0.512 inch
 12 ... 13 mm / 0.47 ... 0.51 inch

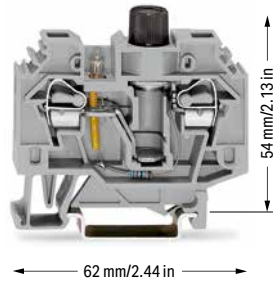

2-conductor fuse terminal block; for glass cartridge fuse ¼" x 1¼"; with 250 VAC/220 VDC neon lamp

Color	Item No.	Pack. Unit
○ gray	282-128/281-417	40

2-conductor fuse terminal block; for 5 x 20 mm miniature metric fuse; with 250 VAC/220 VDC neon lamp

○ gray	282-124	40
--------	---------	----

2-conductor fuse terminal block; for glass cartridge fuse ¼" x 1¼"; with 120 VAC/DC neon lamp

○ gray	282-128/281-418	40
--------	-----------------	----

Accessories; item-specific

Glass cartridge fuse; without indicator; ¼" x 1¼"; 10 A / 250 V; medium-acting



282-457	200 (100)
---------	-----------

Glass cartridge fuse; without indicator; ¼" x 1¼"; very fast-acting



282-454	200 (10)
---------	----------

Accessories; item-specific

Glass cartridge fuse; without indicator; 5 x 20 mm; 6.3 A / 250 V; medium-acting



282-451	100
---------	-----

Glass cartridge fuse; without indicator; ¼" x 1¼"; 10 A / 250 V; medium-acting



282-457	200 (100)
---------	-----------

Glass cartridge fuse; without indicator; ¼" x 1¼"; very fast-acting



282-454	200 (10)
---------	----------

① 500 V = rated voltage
 6 kV = rated impulse voltage
 3 = pollution degree
 (see Section 15)
 Electrical ratings are given by the fuse or LED nominal voltage (see page 344).

Approvals and corresponding ratings, visit www.wago.com

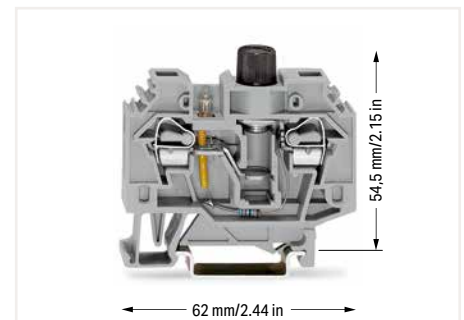

Dimensions in mm
 Item No. 282-124

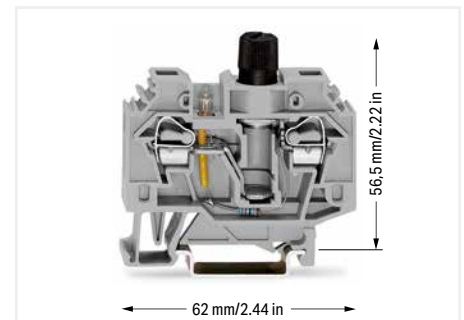

Dimensions in mm
 Item No. 282-128/281-418

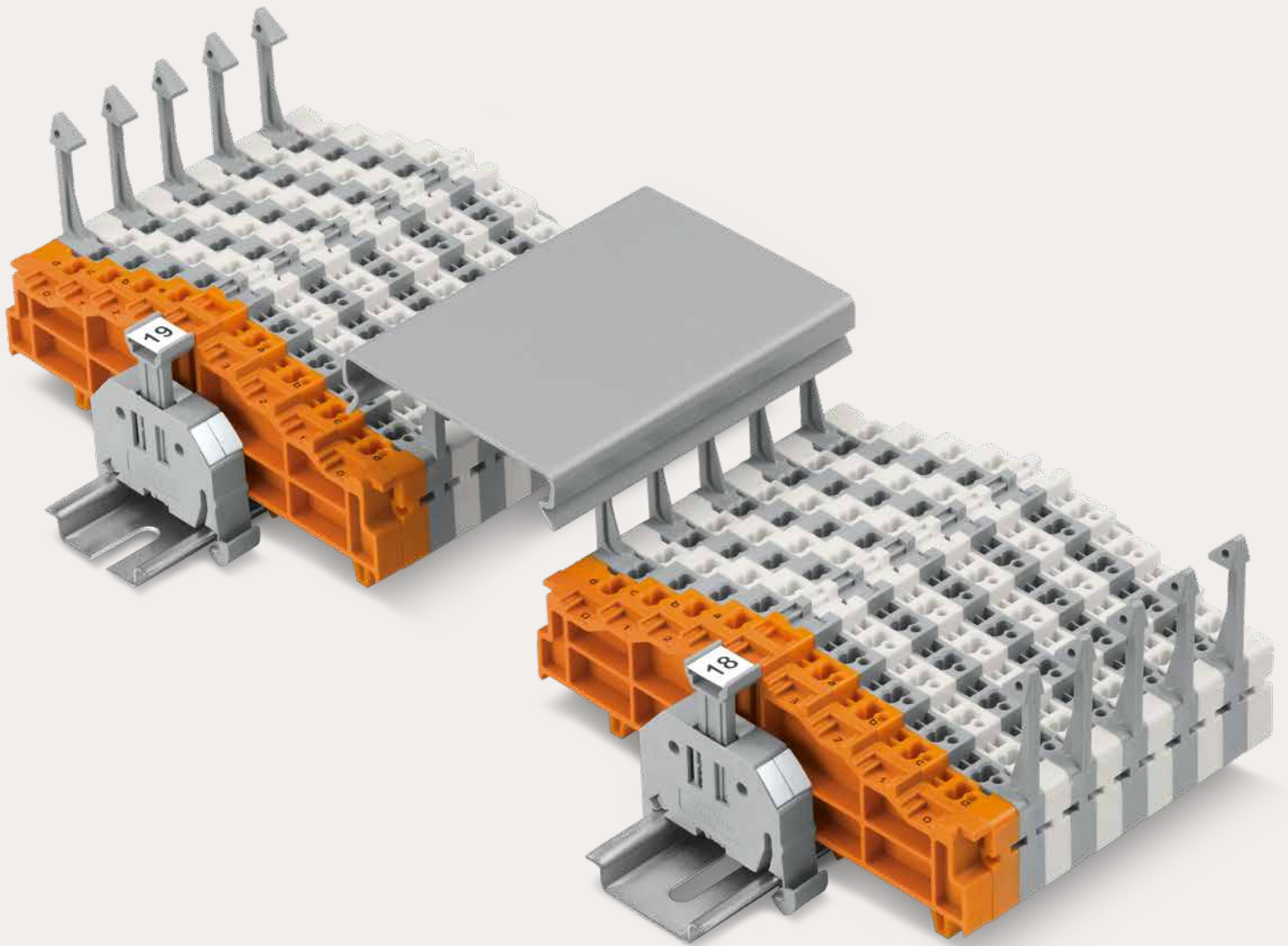







WAGO Patchboard Systems

WAGO Busbar Terminal Blocks

WAGO Patchboard Systems

WAGO Busbar Terminal Blocks

			Page
	Matrix Patchboards	726 Series	550
	Common Potential Matrix Patchboards Marking on the Patchboard Side Marking on the Supply Side	726 Series	554
	Matrix Patchboard Accessories		558
	Terminal Blocks for Matrix Patching and Common Potential Terminal Blocks 1.5 mm ² (16 AWG)	727 Series	562
	3-Conductor, Double-Potential Terminal Blocks 2.5 mm ² (14 AWG)	280 Series	567
	Busbar Terminal Blocks	812 Series	569

Matrix Patchboards

726 Series

Description and Installation



CAGE CLAMP® connection
Inserting a conductor via 210-719 Operating Tool (2.5 x 0.4 mm blade).



Factory-marked modules
Side 1: 1, 2, 3, 4 ...



Testing with a 2.3 mm Ø test plug.

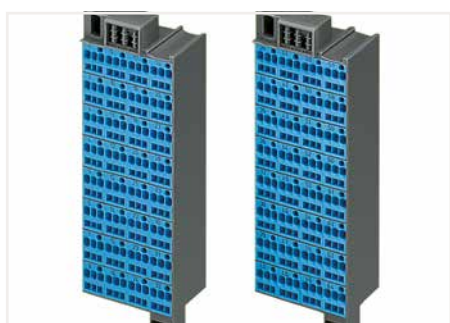

Blue matrix patchboards are suitable for Ex i applications.



WFB continuous marking strip – fits into the matrix patchboards' marker slot and group marker carrier.

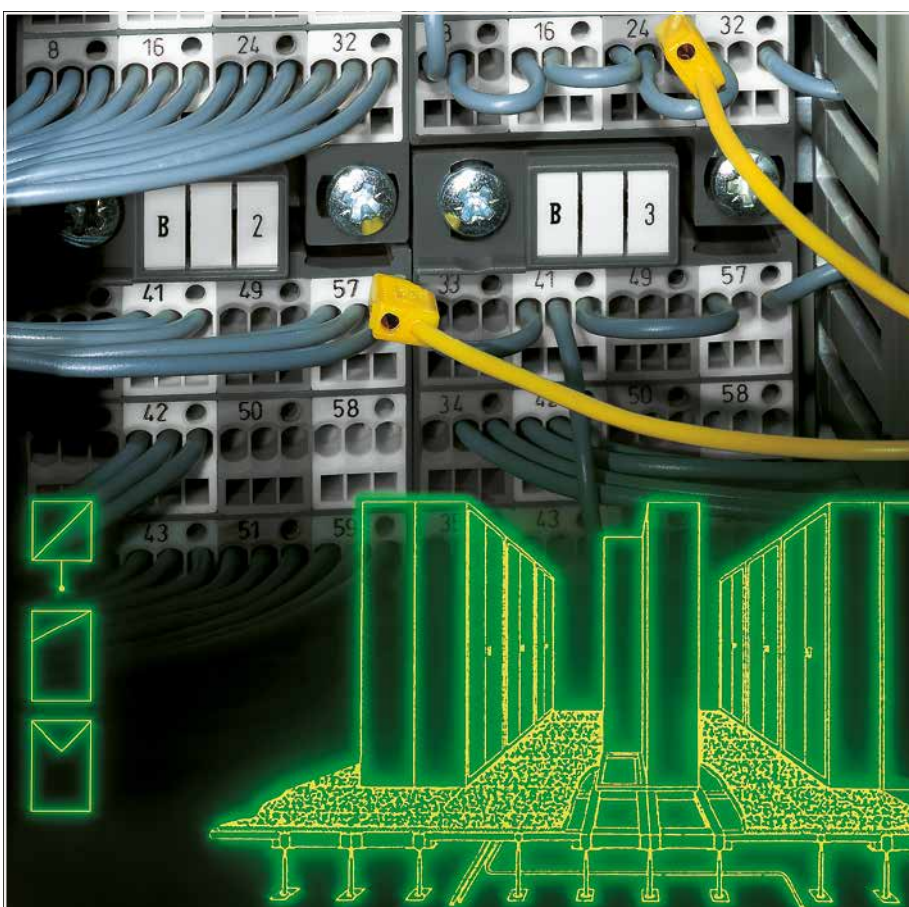

12



Individual group marking via WSB Quick Marking System.



Installation example:
Matrix patchboards in a frame

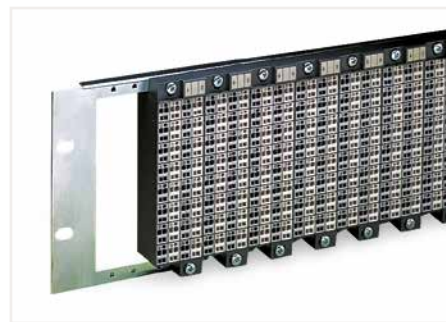

Installation example:
Matrix patchboards in a 19" rack



CAGE CLAMP® terminates the following copper conductors:
solid "s"



stranded "st"



fine-stranded "f-st",
also with tinned
single strands



Space saving:
Slimline matrix patchboard (lower right), mounted upside down

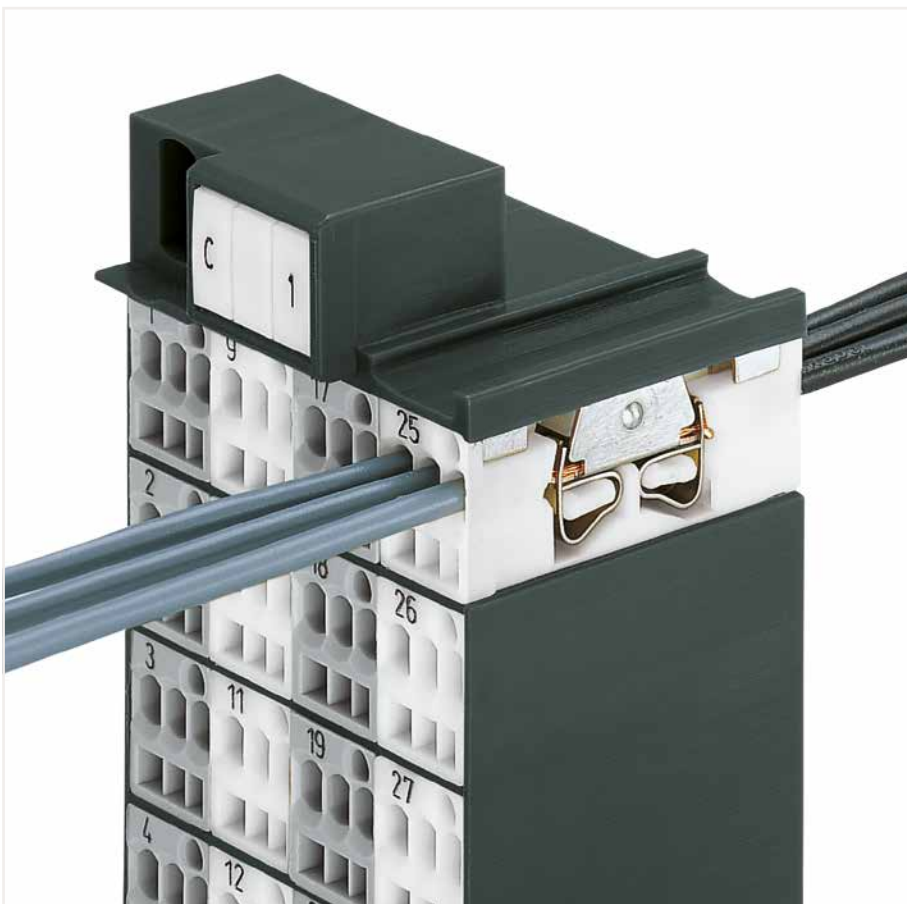

Snapping on an additional module with contact to mounting frame.



Assembling a matrix patchboard with additional module – direct connection to the mounting frame.

	Max. conductor cross section (mm ² /AWG) without ferrule	Max. conductor cross section (mm ² /AWG) with ferrule			
		insulated		uninsulated	
Side 2	1.5	0.75	Item No./Color 216-202/ gray	1	Item No. 216-103
Side 1	1.5	0.75	216-202/ gray	1	216-103
Side 2	2.5	1.5	216-204/ black	1.5	216-104
Side 1	1.5	0.75	216-202/ gray	1	216-103



Terminating ferruled conductors via operating tool.



fine-stranded, tip-bonded



fine-stranded, with ferrule (gastight crimped)



fine-stranded, with pin terminal (gastight crimped)

Matrix Patchboard; 32-Pole 726 Series

Technical Data		Technical Data	
Side 1: 3x 0.08 ... 1.5 mm ²	28 ... 16 AWG	Side 1: 3x 0.08 ... 1.5 mm ²	28 ... 16 AWG
Side 2: 3x 0.08 ... 1.5 mm ²	28 ... 16 AWG	Side 2: 2x 0.08 ... 2.5 mm ²	28 ... 14 AWG
500 V/6 kV/3 ①	300 V, 10 A	500 V/6 kV/3 ①	300 V, 10 A
I _N 10 A	300 V, 10 A	I _N 10 A	300 V, 10 A
8 ... 10 mm / 0.31 ... 0.39 inch		8 ... 10 mm / 0.31 ... 0.39 inch	



Dimensions in mm

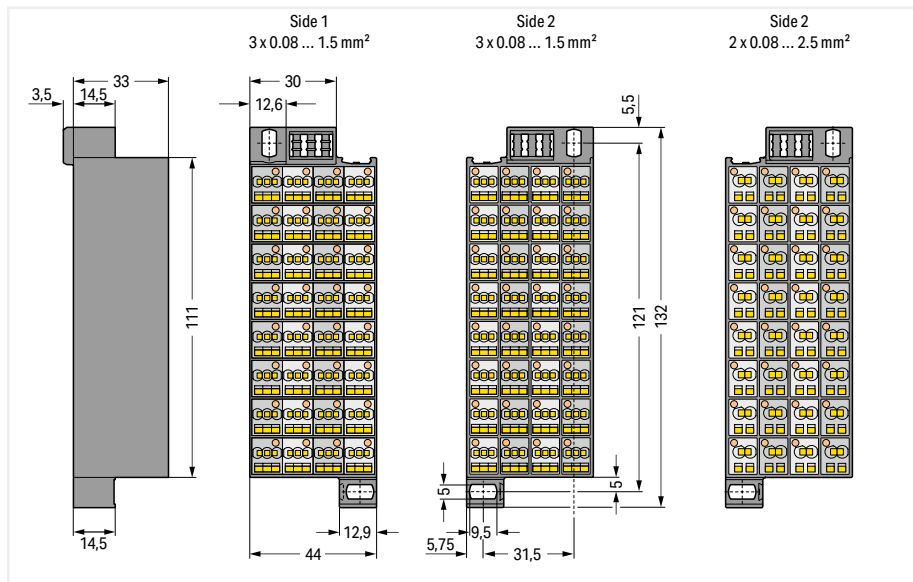

Matrix patchboard; Dark gray frame; Gray/white modules; Vertical module marking on sides 1 and 2; 32-pole			Matrix patchboard; Dark gray frame; Gray/white modules; Vertical module marking on sides 1 and 2; 32-pole		
Marking	Item No.	Pack. Unit	Marking	Item No.	Pack. Unit
1 ... 32	726-121	20	1 ... 32	726-221	20
33 ... 64	726-122	20	33 ... 64	726-222	20

Matrix patchboard; Dark gray frame; Blue modules; Vertical module marking on sides 1 and 2; 32-pole			Matrix patchboard; Dark gray frame; Blue modules; Vertical module marking on sides 1 and 2; 32-pole		
Marking	Item No.	Pack. Unit	Marking	Item No.	Pack. Unit
1 ... 32	726-141 ②	20	1 ... 32	726-241 ②	20
33 ... 64	726-142 ②	20	33 ... 64	726-242 ②	20

Accessories; for Matrix Patchboards
Appropriate marking systems: WMB/WMB Inline/Marking strips

Insulation stop; 0.08 ... 0.2 mm ² "s" (0.14 mm ² "f-st"); 4 x 3 pcs/strip	white	726-901	200 (25)	Insulation stop; 0.25 ... 0.5 mm ² "s+f-st"; 4 x 3 pcs/strip	dark gray	726-907	200 (25)
Insulation stop; 0.25 mm ² "s"; 0.14 ... 0.25 mm ² "f-st"; 4 x 3 pcs/strip	light gray	726-906	200 (25)	Wire commoning chain; insulated; 32 connections; I _N 6 A; max. 50 V; 0.5 mm ²	gray	709-107	1

① 500 V = rated voltage
6 kV = rated impulse voltage
3 = pollution degree
(see Section 15)

② Suitable for Ex i applications

See application notes for:
Insulation stop, page 559

Approvals and corresponding ratings,
visit www.wago.com

Accessories; for Matrix Patchboards

Appropriate marking systems:
WMB/WMB Inline/Marking strips

Group marker carrier for side 2

	dark gray	726-902	50
--	-----------	---------	----

WSB marker card; white; 10 strips with 10 markers/card; for 5 ... 17.5 mm terminal block width

	plain	209-501	5
--	-------	---------	---

WSB marker card; white; 10 strips with 10 markers/card; horizontal marking

	1 ... 10 (10x)	209-502	5
--	----------------	---------	---

WSB marker card; white; 10 strips with 10 markers/card; horizontal marking

	1 ... 50 (2x)	209-566	5
--	---------------	---------	---

WSB marker card; white; 10 strips with 10 markers/card; horizontal marking

	X (100x)	209-500/209-035	5
--	----------	-----------------	---

Operating tool with a partially insulated shaft; Type 1; (2.5 x 0.4) mm blade

		210-719	1
--	--	---------	---

12

Matrix Patchboard; 48-Pole 726 Series

Technical Data	
Side 1: 3x 0.08 ... 1.5 mm ²	28 ... 16 AWG
Side 2: 3x 0.08 ... 1.5 mm ²	28 ... 16 AWG
500 V/6 kV/3 ①	300 V, 10 A
I _N 10 A	300 V, 10 A
8 ... 10 mm / 0.31 ... 0.39 inch	

Technical Data	
Side 1: 3x 0.08 ... 1.5 mm ²	28 ... 16 AWG
Side 2: 2x 0.08 ... 2.5 mm ²	28 ... 14 AWG
500 V/6 kV/3 ①	300 V, 10 A
I _N 10 A	300 V, 10 A
8 ... 10 mm / 0.31 ... 0.39 inch	

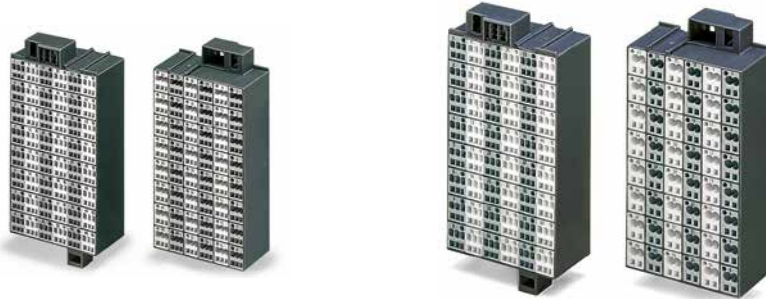

Dimensions in mm



Matrix patchboard; Dark gray frame; Gray/white modules; Vertical module marking on sides 1 and 2; 48-pole

Marking	Item No.	Pack. Unit
1 ... 48	726-421	10

Matrix patchboard; Gray/white modules; Module marking on dark gray frame; Vertical module marking on sides 1 and 2; 48-pole

Marking	Item No.	Pack. Unit
1 ... 48	726-521	10

Matrix patchboard; Dark gray frame; Blue modules; Vertical module marking on sides 1 and 2; 48-pole

1 ... 48	726-441 ②	10
----------	-----------	----

Matrix patchboard; Dark gray frame; Blue modules; Vertical module marking on sides 1 and 2; 48-pole

1 ... 48	726-541 ②	10
----------	-----------	----

Accessories; for Matrix Patchboards

Appropriate marking systems: WMB/WMB Inline/Marking strips

Insulation stop; 0.08 ... 0.2 mm² "s" (0.14 mm² "f-st"); 4 x 3 pcs/strip

white	726-901	200 (25)
-------	---------	----------

Insulation stop; 0.25 mm² "s"; 0.14 ... 0.25 mm² "f-st"; 4 x 3 pcs/strip

light gray	726-906	200 (25)
------------	---------	----------

Insulation stop; 0.25 ... 0.5 mm² "s+f-st"; 4 x 3 pcs/strip

dark gray	726-907	200 (25)
-----------	---------	----------

Wire commoning chain; insulated; 32 connections; I_N 6 A; max. 50 V; 0.5 mm²

gray	709-107	1
------	---------	---

Group marker carrier for side 2

dark gray	726-902	50
-----------	---------	----

① 500 V = rated voltage
6 kV = rated impulse voltage
3 = pollution degree
(see Section 15)

② Suitable for Ex i applications

See application notes for:
Insulation stop, page 559

Approvals and corresponding ratings,
visit www.wago.com

Accessories; for Matrix Patchboards

Appropriate marking systems:
WMB/WMB Inline/Marking strips

WSB marker card; white; 10 strips with 10 markers/card;
for 5 ... 17.5 mm terminal block width

plain	209-501	5
-------	---------	---

WSB marker card; white; 10 strips with 10 markers/card;
horizontal marking

1 ... 10 (10x)	209-502	5
----------------	---------	---

WSB marker card; white; 10 strips with 10 markers/card;
horizontal marking

1 ... 50 (2x)	209-566	5
---------------	---------	---

WSB marker card; white; 10 strips with 10 markers/card;
horizontal marking

X (100x)	209-500/209-035	5
----------	-----------------	---

Operating tool with a partially insulated shaft; Type 1; (2.5 x 0.4) mm blade

	210-719	1
--	---------	---

Matrix Patchboard; 80-Pole 726 Series

Technical Data		Technical Data	
Side 1: 3x 0.08 ... 1.5 mm ²	28 ... 16 AWG	Side 1: 3x 0.08 ... 1.5 mm ²	28 ... 16 AWG
Side 2: 3x 0.08 ... 1.5 mm ²	28 ... 16 AWG	Side 2: 2x 0.08 ... 2.5 mm ²	28 ... 14 AWG
500 V/6 kV/3 ①	300 V, 10 A ②	500 V/6 kV/3 ①	300 V, 10 A ②
I _N 10 A	300 V, 10 A ②	I _N 10 A	300 V, 10 A ②
8 ... 10 mm / 0.31 ... 0.39 inch		8 ... 10 mm / 0.31 ... 0.39 inch	

- ① 500 V = rated voltage
6 kV = rated impulse voltage
3 = pollution degree
(see Section 15)
 - ② Suitable for Ex i applications
- See application notes for:
Insulation stop, page 559
- Approvals and corresponding ratings,
visit www.wago.com

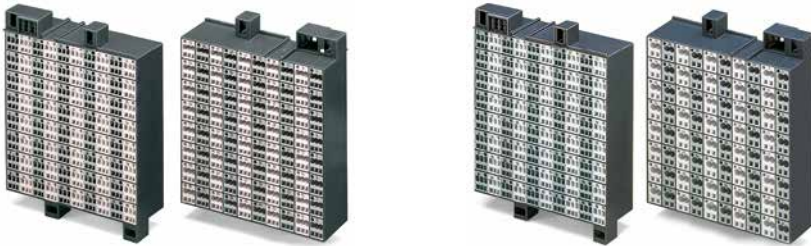

Dimensions in mm

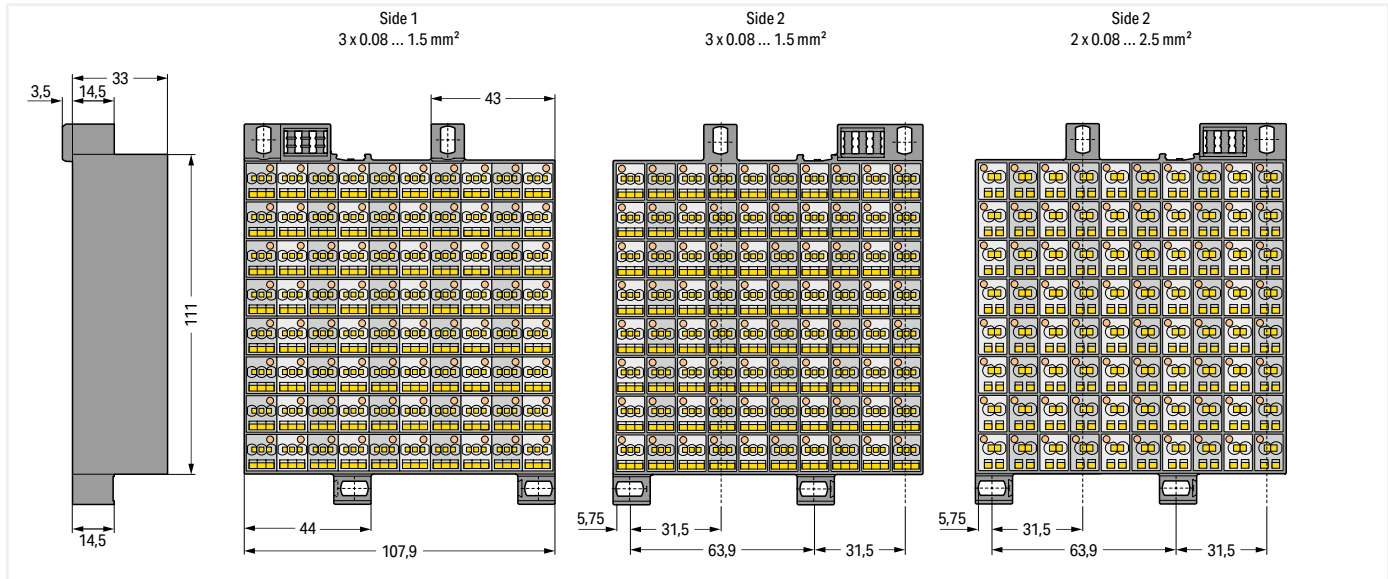

Matrix patchboard; Dark gray frame; Gray/white modules; Vertical module marking on sides 1 and 2; 80-pole	Matrix patchboard; Dark gray frame; Gray/white modules; Vertical module marking on sides 1 and 2; 80-pole
Marking	Marking
Item No.	Item No.
Pack. Unit	Pack. Unit
1 ... 80	1 ... 80
726-721	726-821
8	8
Matrix patchboard; Dark gray frame; Blue modules; Vertical module marking on sides 1 and 2; 80-pole	Matrix patchboard; Dark gray frame; Blue modules; Vertical module marking on sides 1 and 2; 80-pole
Marking	Marking
Item No.	Item No.
Pack. Unit	Pack. Unit
1 ... 80	1 ... 80
726-741 ②	726-841 ②
8	8

Accessories; for Matrix Patchboards

Appropriate marking systems:
WMB/WMB Inline/Marking strips

WSB marker card; white; 10 strips with 10 markers/card; horizontal marking

X (100x)	209-500/209-035	5
----------	-----------------	---

Operating tool with a partially insulated shaft; Type 1; (2.5 x 0.4) mm blade

	210-719	1
--	---------	---

Accessories; for Matrix Patchboards

Appropriate marking systems: WMB/WMB Inline/Marking strips

Insulation stop; 0.08 ... 0.2 mm ² "s" (0.14 mm ² "f-st"); 4 x 3 pcs/strip	WSB marker card; white; 10 strips with 10 markers/card; for 5 ... 17.5 mm terminal block width
white	plain
726-901	209-501
200 (25)	5
Insulation stop; 0.25 mm ² "s"; 0.14 ... 0.25 mm ² "f-st"; 4 x 3 pcs/strip	WSB marker card; white; 10 strips with 10 markers/card; horizontal marking
light gray	1 ... 10 (10x)
726-906	209-502
200 (25)	5
Insulation stop; 0.25 ... 0.5 mm ² "s+f-st"; 4 x 3 pcs/strip	WSB marker card; white; 10 strips with 10 markers/card; horizontal marking
dark gray	1 ... 50 (2x)
726-907	209-566
200 (25)	5

12

Matrix Patchboard; Slimline Version; for 19" Racks; 32-Pole 726 Series

Technical Data		Technical Data	
Side 1: 2x 0.08 ... 1.5 mm ²	28 ... 16 AWG	Side 1: 2x 0.08 ... 1.5 mm ²	28 ... 16 AWG
Side 2: 2x 0.08 ... 1.5 mm ²	28 ... 16 AWG	Side 2: 2x 0.08 ... 1.5 mm ²	28 ... 16 AWG
500 V/6 kV/3 ①	300 V, 10 A	500 V/6 kV/3 ①	300 V, 10 A
I _N 10 A	300 V, 10 A	I _N 10 A	300 V, 10 A
8 ... 10 mm / 0.31 ... 0.39 inch		8 ... 10 mm / 0.31 ... 0.39 inch	



Dimensions in mm

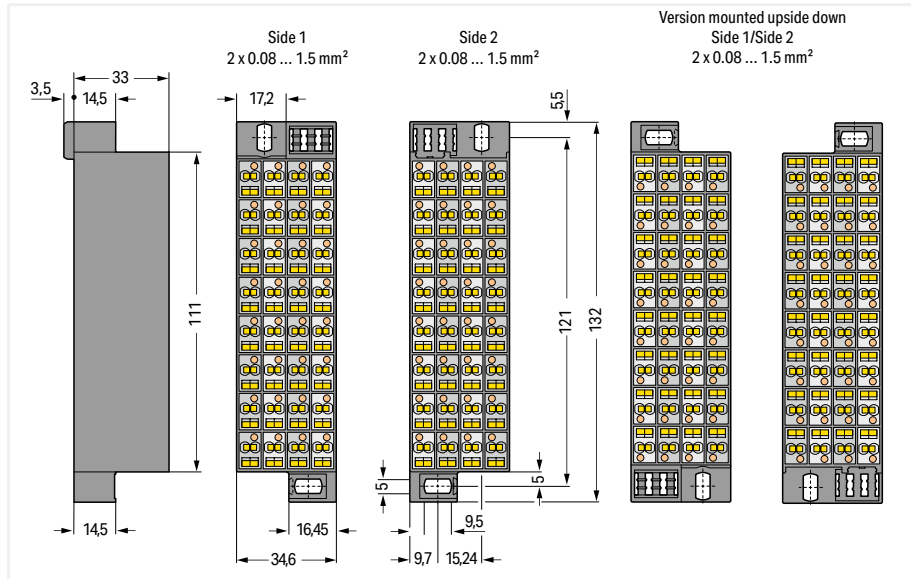

Matrix patchboard; Dark gray frame; Gray/white modules; Vertical module marking on sides 1 and 2; for 19" racks; Slimline version; 32-pole

Marking	Item No.	Pack. Unit	Marking	Item No.	Pack. Unit
1 ... 32	726-321	24	1 ... 32	726-325	24
33 ... 64	726-322	24	33 ... 64	726-326	24

Matrix patchboard; Dark gray frame; Blue modules; Vertical module marking on sides 1 and 2; for 19" racks; Slimline version; 32-pole

1 ... 32	726-341 ②	24
33 ... 64	726-342 ②	24

Matrix patchboard; Dark gray frame; Blue modules; Vertical module marking on sides 1 and 2; for 19" racks; Mounted upside down; Slimline version; 32-pole

1 ... 32	726-345 ②	24
33 ... 64	726-346 ②	24

Accessories; for Matrix Patchboards

Appropriate marking systems: WMB/WMB Inline/Marking strips

Insulation stop; 0.08 ... 0.2 mm² "s"; (0.14 mm² "f-st"); 4 x 3 pcs/strip

white	726-901	200 (25)
-------	---------	----------

Insulation stop; 0.25 mm² "s"; 0.14 ... 0.25 mm² "f-st"; 4 x 3 pcs/strip

light gray	726-906	200 (25)
------------	---------	----------

Insulation stop; 0.25 ... 0.5 mm² "s+f-st"; 4 x 3 pcs/strip

dark gray	726-907	200 (25)
-----------	---------	----------

① 500 V = rated voltage
6 kV = rated impulse voltage
3 = pollution degree
(see Section 15)

② Suitable for Ex i applications

See application notes for:
Insulation stop, page 559

Approvals and corresponding ratings,
visit www.wago.com

Accessories; for Matrix Patchboards

Appropriate marking systems:
WMB/WMB Inline/Marking strips

WSB marker card; white; 10 strips with 10 markers/card; for 5 ... 17.5 mm terminal block width

plain	209-501	5
-------	---------	---

WSB marker card; white; 10 strips with 10 markers/card; horizontal marking

1 ... 10 (10x)	209-502	5
----------------	---------	---

WSB marker card; white; 10 strips with 10 markers/card; horizontal marking

1 ... 50 (2x)	209-566	5
---------------	---------	---

WSB marker card; white; 10 strips with 10 markers/card; horizontal marking

X (100x)	209-500/209-035	5
----------	-----------------	---

Operating tool with a partially insulated shaft; Type 1; (2.5 x 0.4) mm blade

	210-719	1
--	---------	---

Common Potential Matrix Patchboard; Slimline Version; for 19" Racks

726 Series

Technical Data

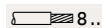
Side 1: I_N 24 A
 24x 2x 0.08 ... 2.5 mm² | 28 ... 14 AWG
 8 ... 10 mm / 0.31 ... 0.39 inch

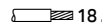
Side 2: I_N 76 A
 1x or 2x 0.5 ... 16 (25 "f-st") mm² | 20 ... 4 AWG
 18 ... 20 mm / 0.71 ... 0.79 inch

Technical Data

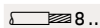
Side 1: I_N 24 A
 24x 2x 0.08 ... 2.5 mm² | 28 ... 14 AWG
 8 ... 10 mm / 0.31 ... 0.39 inch

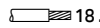
Side 2: I_N 76 A
 1x or 2x 0.5 ... 16 (25 "f-st") mm² | 20 ... 4 AWG
 18 ... 20 mm / 0.71 ... 0.79 inch

Technical Data

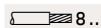
Side 1:
 24x 2x 0.08 ... 2.5 mm² | 28 ... 14 AWG
 8 ... 10 mm / 0.31 ... 0.39 inch

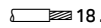
Side 2:
 1x or 2x 0.5 ... 16 (25 "f-st") mm² | 20 ... 4 AWG
 18 ... 20 mm / 0.71 ... 0.79 inch

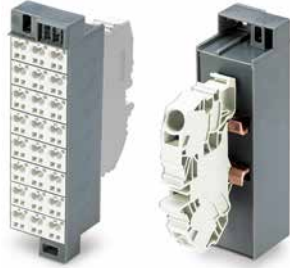

Dimensions in mm

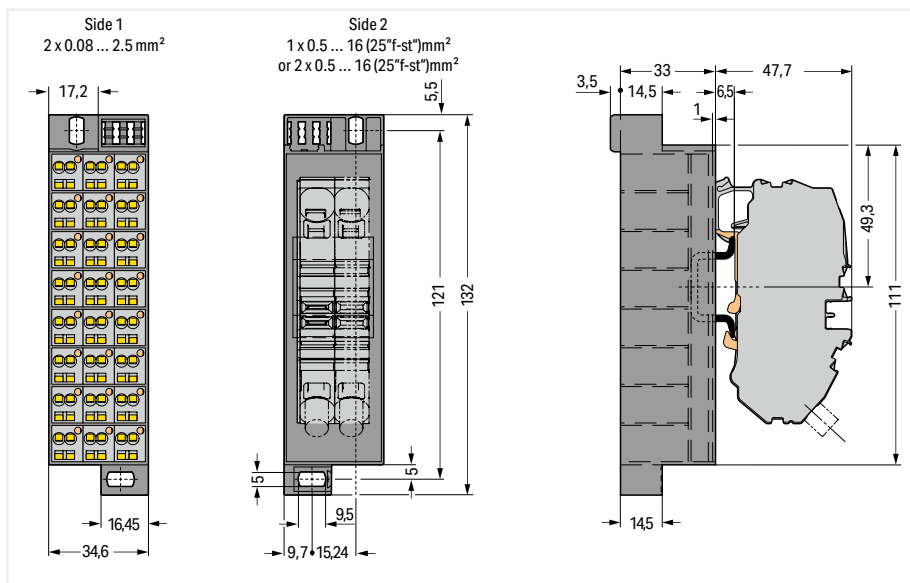

Common potential matrix patchboard; Dark gray frame; Marking 1 ... 24; Gray modules; Vertical module marking; with one supply terminal block incl. end plate; for 19" racks; Slimline version

Item No.	Pack. Unit
726-601	10

Common potential matrix patchboard; Dark gray frame; Marking 1 ... 24; White modules; Vertical module marking; with one supply terminal block incl. end plate; for 19" racks; Slimline version

Item No.	Pack. Unit
726-611	10

Common potential matrix patchboard; Dark gray frame; Marking 1 ... 24; Green-yellow modules; Vertical module marking; with one supply terminal block incl. end plate; for 19" racks; Slimline version

Item No.	Pack. Unit
726-621	10

12

Common potential matrix patchboard; Dark gray frame; Marking 1 ... 24; Gray modules; Vertical module marking; with two supply terminal blocks incl. end plate; for 19" racks; Slimline version

Item No.	Pack. Unit
726-602	10

Common potential matrix patchboard; Dark gray frame; Marking 1 ... 24; White modules; Vertical module marking; with two supply terminal blocks incl. end plate; for 19" racks; Slimline version

Item No.	Pack. Unit
726-612	10

Common potential matrix patchboard; Dark gray frame; Marking 1 ... 24; Green-yellow modules; Vertical module marking; with two supply terminal blocks incl. end plate; for 19" racks; Slimline version

Item No.	Pack. Unit
726-622	10

Accessories; item-specific

Spare supply terminal block; only for use with common potential matrix patchboards (726Series); 16 mm²; 12 mm wide

Color	Item No.	Pack. Unit
gray	2016-7611	20

End and intermediate plate; 1 mm thick

Color	Item No.	Pack. Unit
gray	2016-7691	100 (25)

Operating tool with a partially insulated shaft; Type 3; (5.5 x 0.8) mm blade

Item No.	Pack. Unit
210-721	1

Accessories; item-specific

Spare supply terminal block; only for use with common potential matrix patchboards (726Series); 16 mm²; 12 mm wide

Color	Item No.	Pack. Unit
white	2016-7608	20

End and intermediate plate; 1 mm thick

Color	Item No.	Pack. Unit
gray	2016-7691	100 (25)

Operating tool with a partially insulated shaft; Type 3; (5.5 x 0.8) mm blade

Item No.	Pack. Unit
210-721	1

Accessories; item-specific

Ground supply terminal block; 2-conductor ground terminal block; 16 mm²; 12 mm wide

Color	Item No.	Pack. Unit
green-yellow	2016-7607	20

End and intermediate plate; 1 mm thick

Color	Item No.	Pack. Unit
gray	2016-7691	100 (25)

Operating tool with a partially insulated shaft; Type 3; (5.5 x 0.8) mm blade

Item No.	Pack. Unit
210-721	1

Technical Data

Side 1: I_N 24 A

24x 2x 0.08 ... 2.5 mm² | 28 ... 14 AWG

8 ... 10 mm / 0.31 ... 0.39 inch

Side 2: I_N 76 A

1x or 2x 0.5 ... 16 (25 "f-st") mm² | 20 ... 4 AWG

18 ... 20 mm / 0.71 ... 0.79 inch

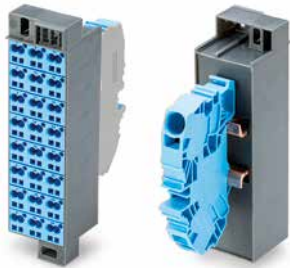

1 Suitable for Ex i applications

See application notes for:
Insulation stop, page 559

Approvals and corresponding ratings,
visit www.wago.com

Accessories; for Common Potential Matrix Patchboards

Appropriate marking systems:
WSB/WFB

Insulation stop; 0.08 ... 0.2 mm² "s" (0.14 mm² "f-st");
4 x 3 pcs/strip

white 726-901 200 (25)



Insulation stop; 0.25 mm² "s"; 0.14 ... 0.25 mm² "f-st";
4 x 3 pcs/strip

light gray 726-906 200 (25)



Insulation stop; 0.25 ... 0.5 mm² "s+f-st"; 4 x 3 pcs/strip

dark gray 726-907 200 (25)



Wire commoning chain; insulated; 32 connections; I_N 6 A;
max. 50 V; 0.5 mm²

gray 709-107 1



Group marker carrier for side 2

dark gray 726-902 50



WFB continuous marking strip; 1000 mm long

transparent 210-612 10



**Carrier for WFB continuous marking strip; snaps into
marker slot**

gray 209-185 200 (25)



Common potential matrix patchboard; Dark gray frame;
Marking 1 ... 24; Blue modules; Vertical module marking;
with one supply terminal block incl. end plate; for 19"
racks; Slimline version

Item No.	Pack. Unit
726-631 1	10

Common potential matrix patchboard; Dark gray frame;
Marking 1 ... 24; Blue modules; Vertical module marking;
with two supply terminal blocks incl. end plate; for 19"
racks; Slimline version

726-632 1	10
------------------	----

Accessories; item-specific

Spare supply terminal block; 2-conductor supply
terminal block for distribution boxes; only for use with
common potential matrix patchboards (726Series);
16 mm²; 12 mm wide

blue 2016-7614 20



End and intermediate plate; 1 mm thick

gray 2016-7691 100 (25)



Accessories; for Common Potential Matrix Patchboards

Appropriate marking systems:
WMB/WMB Inline/WFB

WMB Inline; plain; 1,500 WMB markers (5 mm)/reel;
stretchable 5 ... 5.2 mm

white 2009-115 1



WMB marker card; white; 10 strips with 10 markers/card;
stretchable 5 ... 5.2 mm

plain 793-5501 5



Operating tool with a partially insulated shaft; Type 1; (2.5
x 0.4) mm blade

210-719 1



WSB marker card; white; 10 strips with 10 markers/card;
for 5 ... 17.5 mm terminal block width

plain 209-501 5



WSB marker card; white; 10 strips with 10 markers/card;
horizontal marking

1 ... 10 (10x) 209-502 5



WSB marker card; white; 10 strips with 10 markers/card;
horizontal marking

1 ... 50 (2x) 209-566 5



WSB marker card; white; 10 strips with 10 markers/card;
horizontal marking

X (100x) 209-500/209-035 5



PUSH-IN CAGE CLAMP® CAGE CLAMP®

Common Potential Matrix Patchboard; Slimline Version; for 19" Racks; Supply Side/Patchboard Side

726 Series

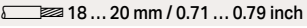
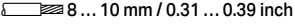
Technical Data	
Side 1: I _N 76 A	
1x or 2x 0.5 ... 16 (25 "f-st") mm ²	20 ... 4 AWG
 18 ... 20 mm / 0.71 ... 0.79 inch	
Side 2: I _N 24 A	
24x 2x 0.08 ... 2.5 mm ²	28 ... 14 AWG
 8 ... 10 mm / 0.31 ... 0.39 inch	

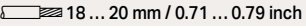
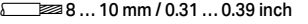
Technical Data	
Side 1: I _N 76 A	
1x or 2x 0.5 ... 16 (25 "f-st") mm ²	20 ... 4 AWG
 18 ... 20 mm / 0.71 ... 0.79 inch	
Side 2: I _N 24 A	
24x 2x 0.08 ... 2.5 mm ²	28 ... 14 AWG
 8 ... 10 mm / 0.31 ... 0.39 inch	

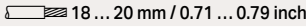
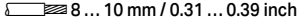
Technical Data	
Side 1:	
1x or 2x 0.5 ... 16 (25 "f-st") mm ²	20 ... 4 AWG
 18 ... 20 mm / 0.71 ... 0.79 inch	
Side 2:	
24x 2x 0.08 ... 2.5 mm ²	28 ... 14 AWG
 8 ... 10 mm / 0.31 ... 0.39 inch	



Dimensions in mm

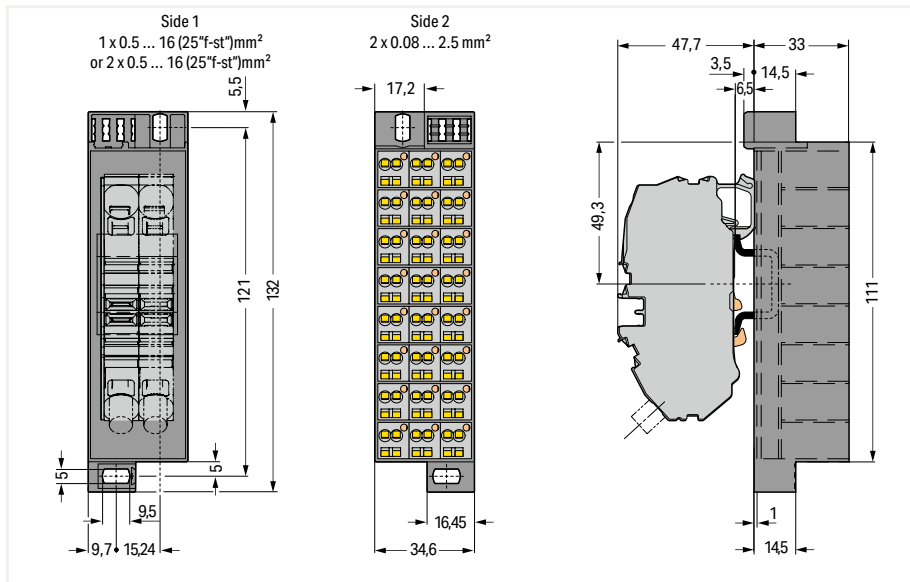

Common potential matrix patchboard; Dark gray frame; with one supply terminal block incl. end plate; Marking 1 ... 24; Gray modules; Vertical module marking; ; for 19" racks; Slimline version

Item No.	Pack. Unit
726-651	10

Common potential matrix patchboard; Dark gray frame; with one supply terminal block incl. end plate; Marking 1 ... 24; White modules; Vertical module marking; ; for 19" racks; Slimline version

Item No.	Pack. Unit
726-661	10

Common potential matrix patchboard; Dark gray frame; with one supply terminal block incl. end plate; Marking 1 ... 24; Green-yellow modules; Vertical module marking; ; for 19" racks; Slimline version

Item No.	Pack. Unit
726-671	10

12

Common potential matrix patchboard; Dark gray frame; with two supply terminal blocks incl. end plate; Marking 1 ... 24; Gray modules; Vertical module marking; for 19" racks; Slimline version

726-652	10
---------	----

Common Potential Matrix Patchboard; Dark gray frame; with two supply terminal blocks incl. end plate; Marking 1 ... 24; White modules; Vertical module marking; for 19" racks; Slimline version

726-662	10
---------	----

Common potential matrix patchboard; Dark gray frame; with two supply terminal blocks incl. end plate; Marking 1 ... 24; Green-yellow modules; Vertical module marking; for 19" racks; Slimline version

726-672	10
---------	----

Accessories; item-specific
Spare supply terminal block; only for use with common potential matrix patchboards (726Series); 16 mm²; 12 mm wide

Color	Item No.	Pack. Unit
gray	2016-7611	20



Accessories; item-specific
Spare supply terminal block; only for use with common potential matrix patchboards (726Series); 16 mm²; 12 mm wide

Color	Item No.	Pack. Unit
white	2016-7608	20



Accessories; item-specific
Ground supply terminal block; 2-conductor ground terminal block; 16 mm²; 12 mm wide

Color	Item No.	Pack. Unit
green-yellow	2016-7607	20



End and intermediate plate; 1 mm thick

Color	Item No.	Pack. Unit
gray	2016-7691	100 (25)



End and intermediate plate; 1 mm thick

Color	Item No.	Pack. Unit
gray	2016-7691	100 (25)



End and intermediate plate; 1 mm thick

Color	Item No.	Pack. Unit
gray	2016-7691	100 (25)



Operating tool with a partially insulated shaft; Type 3; (5.5 x 0.8) mm blade

Item No.	Pack. Unit
210-721	1



Operating tool with a partially insulated shaft; Type 3; (5.5 x 0.8) mm blade

Item No.	Pack. Unit
210-721	1



Operating tool with a partially insulated shaft; Type 3; (5.5 x 0.8) mm blade

Item No.	Pack. Unit
210-721	1



Matrix Patchboard; with Push-Buttons; Slimline Version; for 19" Racks; 32-Pole 726 Series

Technical Data	
Side 1: 2x 0.2 ... 1.5 mm ² ①	24 ... 16 AWG
Side 2: 2x 0.2 ... 1.5 mm ² ①	24 ... 16 AWG
800 V/8 kV/3 ②	300 V, 10 A VA
I _N 10 A	300 V, 10 A Ⓒ
10 mm / 0.39 inch	



Technical Data	
Side 1: 2x 0.2 ... 1.5 mm ² ①	24 ... 16 AWG
Side 2: 2x 0.2 ... 1.5 mm ² ①	24 ... 16 AWG
800 V/8 kV/3 ②	300 V, 10 A VA
I _N 10 A	300 V, 10 A Ⓒ
10 mm / 0.39 inch	

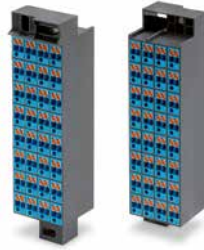

- ① Conductor range: 0.2 ... 1.5 mm² "s+f-st" and 0.25 ... 1 mm² "insulated ferrules; 10 mm"
 - ② 800 V = rated voltage
8 kV = rated impulse voltage
3 = pollution degree (see Section 15)
 - ③ Suitable for Ex i applications
- See application notes for:
Marking, from page 640
- Approvals and corresponding ratings,
visit www.wago.com

Accessories; for Matrix Patchboards

Appropriate marking systems:
WMB/WMB Inline/WFB

Operating tool with a partially insulated shaft; Type 1; (2.5 x 0.4) mm blade

210-719 1



Test probe; 2 mm Ø; min. 12 mm lon; uninsulated tip; not offered by WAGO (e.g., MultiContact XPP-80/2-16)

Dimensions in mm

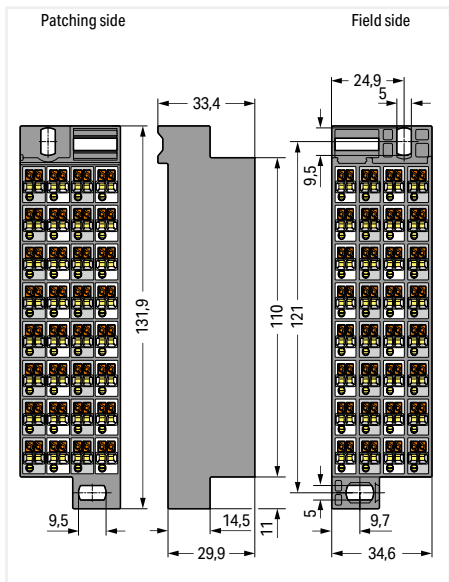

Matrix patchboard; Dark gray frame; Gray/white modules; for 19" racks; Slimline version; 32-pole

Marking	Item No.	Pack. Unit
plain	726-770	30

Matrix patchboard; Dark gray frame; Gray/white modules; Vertical module marking on sides 1 and 2; for 19" racks; Slimline version; 32-pole

1 ... 32	726-771	30
----------	---------	----

Matrix patchboard; Dark gray frame; White/gray modules; for 19" racks; Slimline version; 32-pole

plain	726-780	30
-------	---------	----

Dimensions in mm

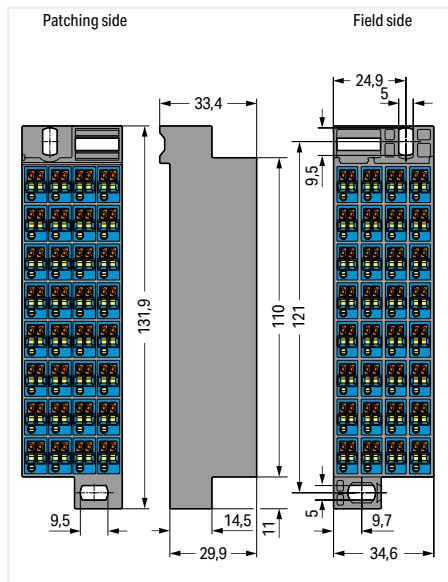

Matrix patchboard; Dark gray frame; Blue modules; for 19" racks; Slimline version; 32-pole

Marking	Item No.	Pack. Unit
plain	726-800 ③	30

Matrix patchboard; Dark gray frame; Blue modules; Vertical module marking on sides 1 and 2; for 19" racks; Slimline version; 32-pole

1 ... 32	726-801 ③	30
----------	-----------	----

Accessories; for Matrix Patchboards

Appropriate marking systems: WMB/WMB Inline/WFB

Wire commoning chain; insulated; 32 connections; I_N 6 A; max. 50 V; 0.5 mm²

gray	709-107	1
------	---------	---



WMB marker card; white; 10 strips with 10 markers/card; stretchable 5 ... 5.2 mm

plain	793-5501	5
-------	----------	---



WMB Inline; plain; 1,500 WMB markers (5 mm)/reel; stretchable 5 ... 5.2 mm

white	2009-115	1
-------	----------	---



Additional Module for Matrix Patchboards 726 Series

Technical Data

0.08 ... 4 mm ²	28 ... 14 AWG
0.08 ... 2.5 mm ²	28 ... 14 AWG
500 V/6 kV/3 ①	300 V, 10 A ②
I _N 10 A	
9 mm / 0.35 inch	

- ① 500 V = rated voltage
6 kV = rated impulse voltage
3 = pollution degree
(see Section 15)
 - ② Suitable for Ex i applications
- See application notes for:
Insulation stop, page 559
- Approvals and corresponding ratings,
visit www.wago.com



Dimensions in mm

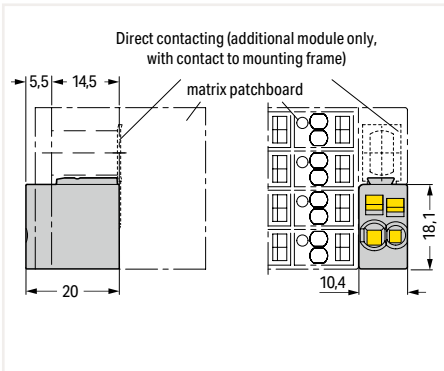

Additional module for matrix patchboard; for snap-on mounting to the lower mounting adapter; with CAGE CLAMP®; Additional module with contact to the mounting frame

Color	Item No.	Pack. Unit
○ white	726-903	25



Snapping on an additional module with contact to mounting frame.



Assembling a matrix patchboard with additional module – direct connection to the mounting frame.



Additional module for matrix patchboards; snaps onto the lower mounting adapter; with CAGE CLAMP®; insulated

Color	Item No.	Pack. Unit
○ gray	726-904	25

Insulation Stop; for Matrix Patchboard 726 Series

Suitable for patchboard side (side 1) of 1.5 mm² matrix patchboards (front side differs from back side)



Insulation stop; 0.08 ... 0.2 mm² "s" (0.14 mm² "f-st");
4 x 3 pcs/strip

Color	Item No.	Pack. Unit
○ white	726-901	200 (25)

Insulation stop; 0.25 mm² "s"; 0.14 ... 0.25 mm² "f-st";
4 x 3 pcs/strip

○ gray	726-906	200 (25)
--------	---------	----------

Insulation stop; 0.25 ... 0.5 mm² "s+f-st"; 4 x 3 pcs/strip

● dark gray	726-907	200 (25)
-------------	---------	----------



Inserting an insulation stop into conductor entry holes of matrix patchboards.



Mounted insulation stop

Terminal Blocks for Matrix Patching and Common Potential Terminal Blocks

727 Series

Description and Installation



Snap individual 4- or 8-level terminal blocks onto the DIN-rail.

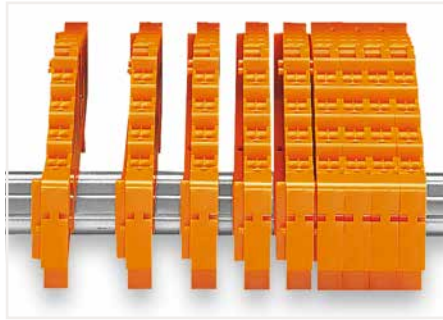

Slide terminal blocks together.

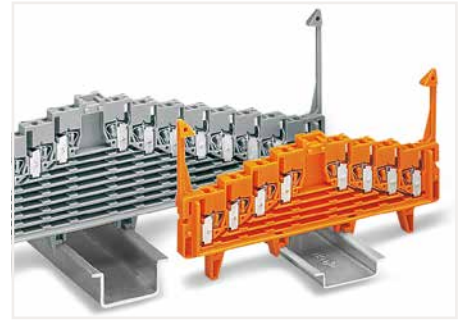

Terminal blocks for DIN-35 x 7.5 mm or DIN-35 x 15 mm rails are available.



Grip end plate at both sides and:

- push down (assembly)
- pull up (removal)

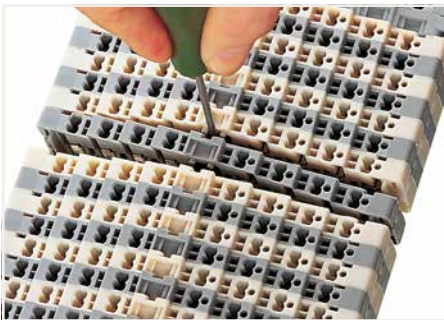

Open the assembly by laterally sliding a block via operating tool (2.5 x 0.4 mm blade).

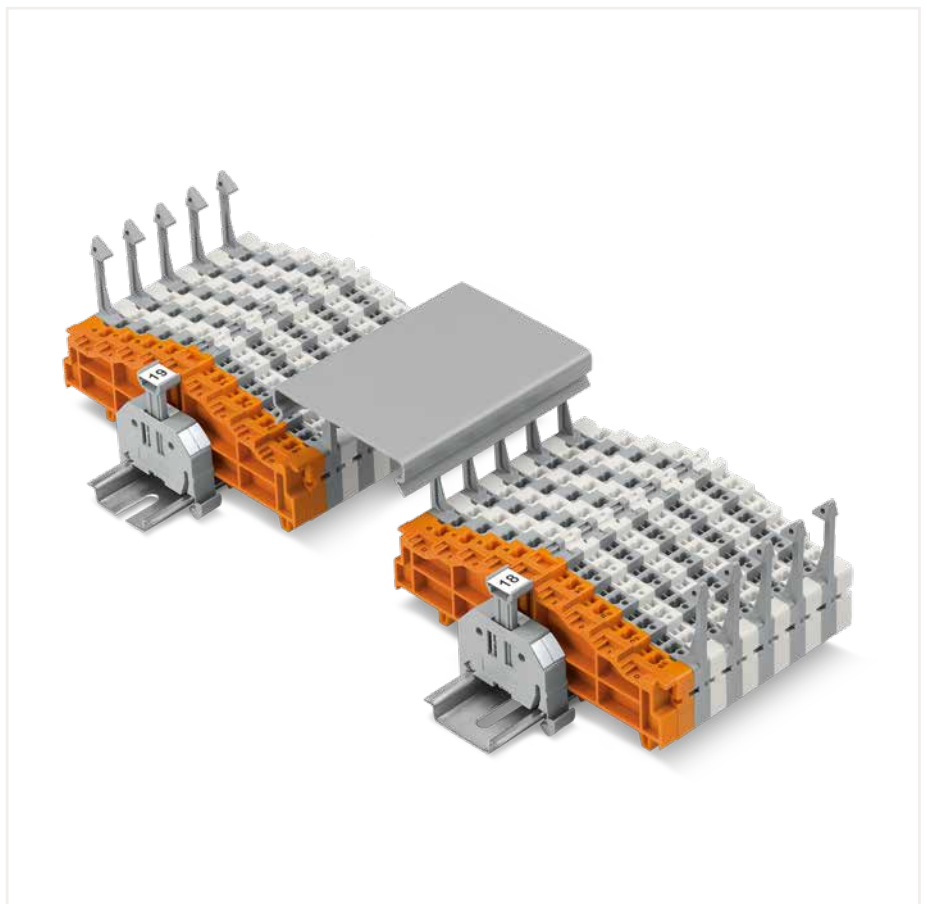

12



Slide terminal block and remove from the rail with a levering action.

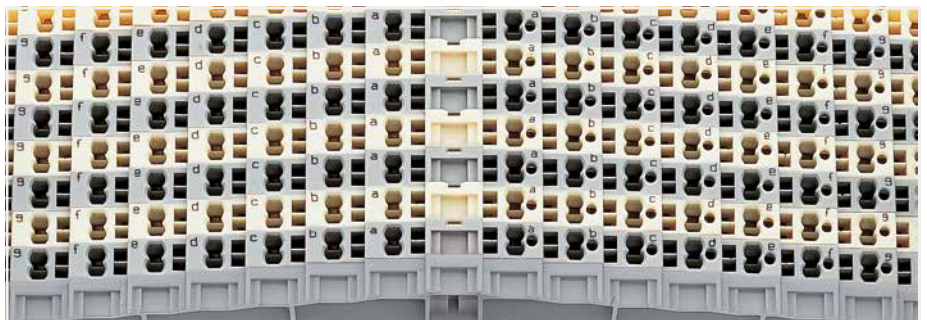

Connection points identified via factory-direct printing



CAGE CLAMP® terminates the following copper conductors: solid "s"



stranded "st"



fine-stranded "f-st", also with tinned single strands

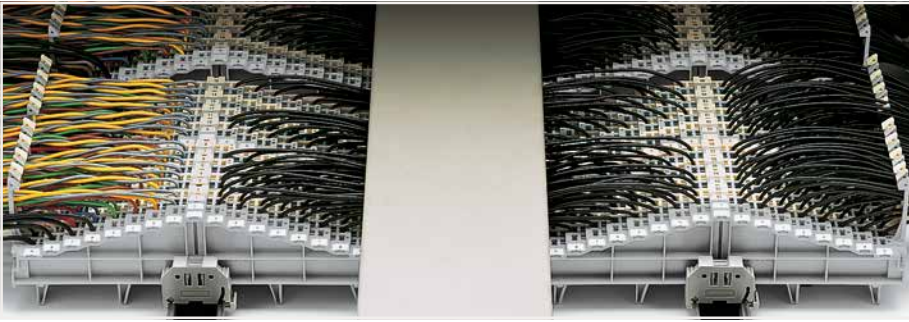

Example:
Left: Main cables fed through locking clips on the field side
Right: Control cables fed between locking clips
Center: Wiring of both patching sides



Using terminal blocks with locking clips, the wiring space between the terminal strips can be covered with a wiring duct cover.

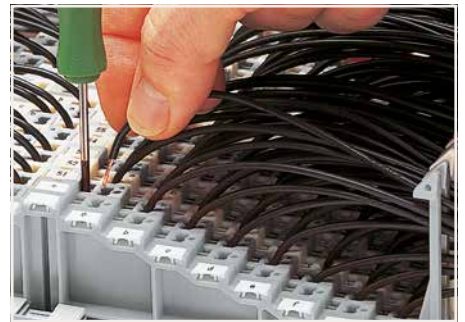
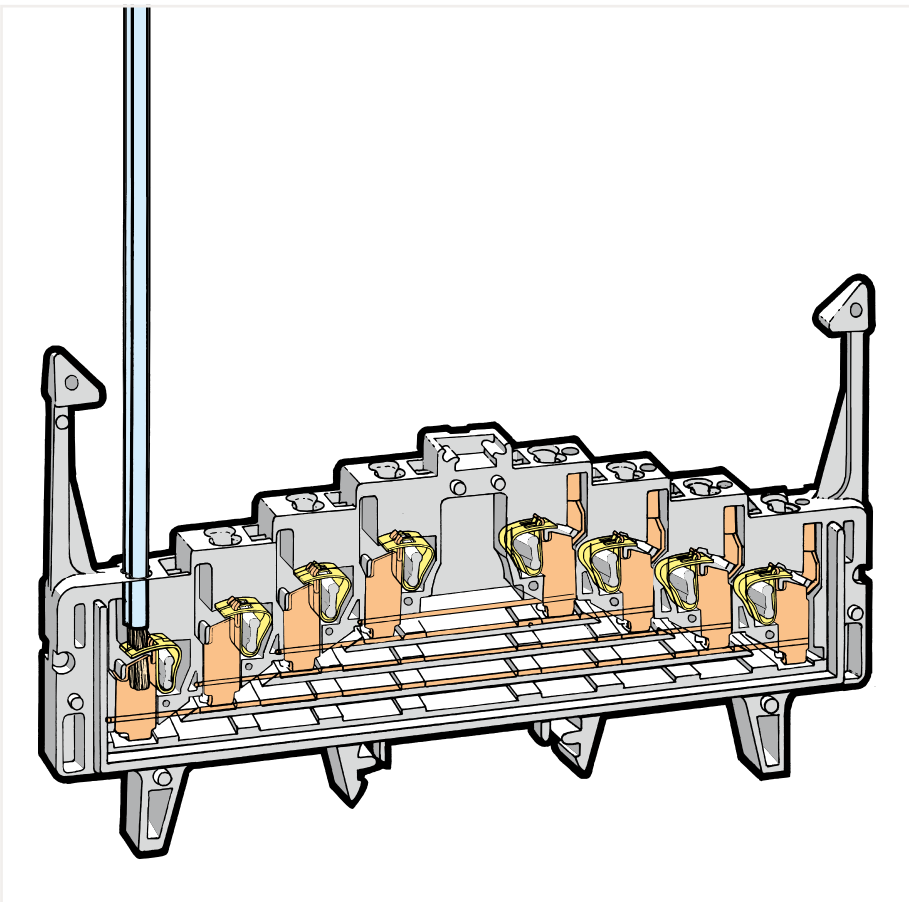

CAGE CLAMP® connection
Inserting a conductor via 210-719 Operating Tool (2.5 x 0.4 mm blade).
Max. cross section for uninsulated ferrules 1 mm² (18 AWG), for insulated ferrules 0.75 mm² (20 AWG)



Special test contact for step-down test plug; from 4 mm socket to 2 mm plug; max. 42 V

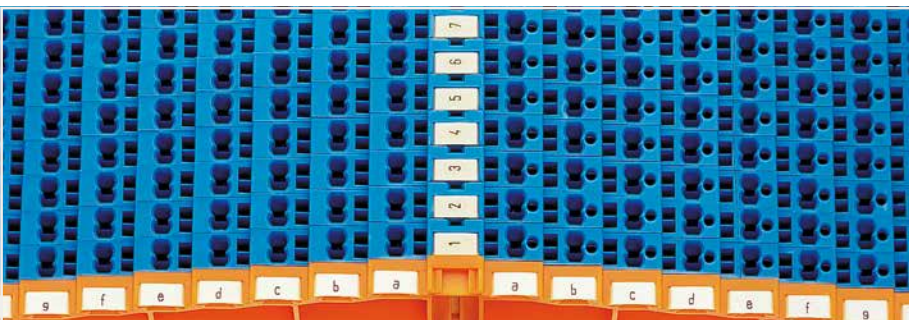

Marking coordinates via WMB Multi Marking System.

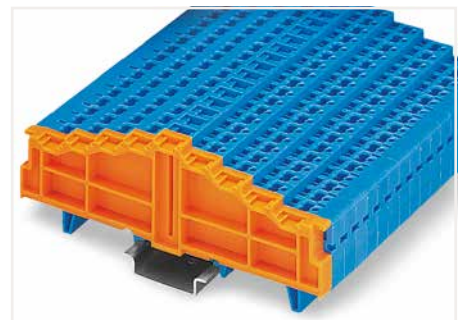

Blue terminal blocks for matrix patching are suitable for Ex i applications.



fine-stranded, tip-bonded



fine-stranded, with ferrule (gastight crimped)



fine-stranded, with pin terminal (gastight crimped)

4-Level Terminal Block for Matrix Patching

1.5 mm²; 727 Series

Technical Data	
0.08 ... 1.5 mm ²	28 ... 16 AWG
250 V/4 kV/3 ①	300 V, 10 A
I _N 12 A	300 V, 10 A
Terminal block width: 7.62 mm / 0.3 inch	
8 ... 10 mm / 0.31 ... 0.39 inch	

Technical Data	
0.08 ... 1.5 mm ²	28 ... 16 AWG
250 V/4 kV/3 ①	300 V, 10 A
I _N 12 A	300 V, 10 A
Terminal block width: 7.62 mm / 0.3 inch	
8 ... 10 mm / 0.31 ... 0.39 inch	

- ① 250 V = rated voltage
4 kV = rated impulse voltage
3 = pollution degree
(see Section 15)
 - ② Terminal blocks with a blue insulated housing are suitable for Ex i applications.
60 V = peak value ^ (table 4, EN 60079-11 when approved by the manufacturer's authorized inspection representative)
- See application notes for:
Wire harness support, page 567
Marking, from page 640
- Approvals and corresponding ratings, visit www.wago.com

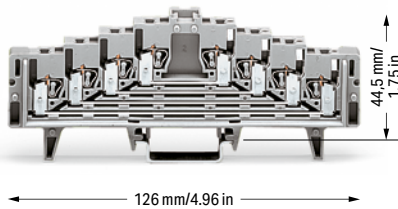
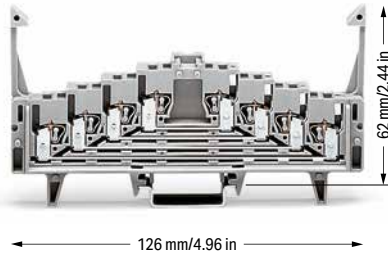

4-level terminal block for matrix patching; with locking clips; no marking; 4 x pairs of clamping units on the same level; for DIN 35 x 7.5 rail

Color	Item No.	Pack. Unit
gray	727-219	50
white	727-221	50
blue	727-223 ②	50

4-level terminal block for matrix patching; without locking clips; no marking; 4 x pairs of clamping units on the same level; for DIN 35 x 7.5 rail

Color	Item No.	Pack. Unit
gray	727-220	50
white	727-222	50
blue	727-224 ②	50

4-level terminal block for matrix patching; with locking clips; no marking; 4 x pairs of clamping units on the same level; for DIN 35 x 15 rail

Color	Item No.	Pack. Unit
gray	727-229	50
white	727-231	50
blue	727-233 ②	50

4-level terminal block for matrix patching; without locking clips; no marking; 4 x pairs of clamping units on the same level; for DIN 35 x 15 rail

Color	Item No.	Pack. Unit
gray	727-230	50
white	727-232	50
blue	727-234 ②	50

Item no. suffixes for terminal blocks with marking:

0-1-2-3--3-2-1-0	.../021-000
a-b-c-d--d-c-b-a	.../022-000
3-2-1-0--0-1-2-3	.../023-000
d-c-b-a--a-b-c-d	.../024-000

Other terminal blocks with the same profile:

0-1-2-3--3-2-1-0	.../021-000
a-b-c-d--d-c-b-a	.../022-000
3-2-1-0--0-1-2-3	.../023-000
d-c-b-a--a-b-c-d	.../024-000

Accessories; 727 Series
Appropriate marking system: WMB

4-level end plate; no marking; 7.62 mm thick		
	orange	727-217 25
	gray	727-213 25
	blue	727-214 25
4-level end plate; Marking: 0-1-2-3--3-2-1-0; 7.62 mm thick		
	orange	727-205 25
	gray	727-255 25
	blue	727-265 25
4-level end plate; Marking: a-b-c-d--d-c-b-a; 7.62 mm thick		
	orange	727-206 25
	gray	727-256 25
	blue	727-266 25
4-level end plate; Marking: 3-2-1-0--0-1-2-3; 7.62 mm thick		
	orange	727-207 25
	gray	727-257 25
	blue	727-267 25
4-level end plate; Marking: d-c-b-a--a-b-c-d; 7.62 mm thick		
	orange	727-208 25
	gray	727-258 25
	blue	727-268 25

Insulation stop; 0.08 ... 0.2 mm ² "s" (0.14 mm ² "f-st"); 8 pcs/strip		
	white	727-197 200 (25)
Insulation stop; 0.25 mm ² "s"; 0.14 ... 0.25 mm ² "f-st"; 8 pcs/strip		
	light gray	727-198 200 (25)
Insulation stop; 0.25 ... 0.5 mm ² "s+f-st"; 8 pcs/strip		
	dark gray	727-199 200 (25)
Wire commoning chain; insulated; 32 connections; I _N 6 A; max. 50 V; 0.5 mm ²		
	gray	709-107 1
Step-down test plug; from 4 mm socket to 2 mm plug; max. 42 V		
	red	210-297 100 (25)

Accessories; 727 Series
Appropriate marking systems: WMB

Wire harness support			
	gray	249-109	50
Double marker carrier; for center I/O module marking; for WSB and WMB marking systems; 4 mm wide			
	gray	209-128	200 (100)

Operating tool with a partially insulated shaft; Type 1; (2.5 x 0.4) mm blade		
		210-719 1

12

4-Level Common Potential Terminal Block

1.5 mm²; 727 Series

Technical Data	
0.08 ... 1.5 mm ²	28 ... 16 AWG
250 V/4 kV/3 ①	300 V, 10 A
I _N 18 A	300 V, 10 A
Terminal block width: 7.62 mm / 0.3 inch	
8 ... 10 mm / 0.31 ... 0.39 inch	

Technical Data	
0.08 ... 1.5 mm ²	28 ... 16 AWG
250 V/4 kV/3 ①	300 V, 10 A
I _N 18 A	300 V, 10 A
Terminal block width: 7.62 mm / 0.3 inch	
8 ... 10 mm / 0.31 ... 0.39 inch	

- ① 250 V = rated voltage
4 kV = rated impulse voltage
3 = pollution degree
(see Section 15)
- See application notes for:
Wire harness support, page 567
Marking, from page 640
- Approvals and corresponding ratings,
visit www.wago.com

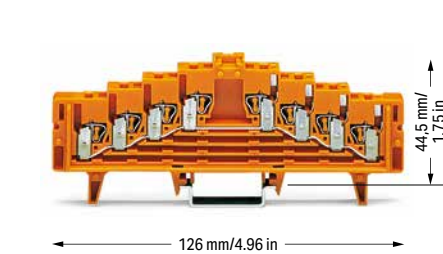

4-level common potential terminal block; with locking clips; no marking; all clamping units connected to the same current bar; for DIN 35 x 7.5 rail

Color	Item No.	Pack. Unit
orange	727-225	50
light gray	727-227	50

4-level terminal block for matrix patching; without locking clips; no marking; all clamping units connected to the same current bar; for DIN 35 x 7.5 rail

Color	Item No.	Pack. Unit
orange	727-226	50
light gray	727-228	50

4-level common potential terminal block; with locking clips; no marking; all clamping units connected to the same current bar; for DIN 35 x 15 rail

orange	727-235	50
light gray	727-237	50

4-level terminal block for matrix patching; without locking clips; no marking; all clamping units connected to the same current bar; for DIN 35 x 15 rail

orange	727-236	50
light gray	727-238	50

Item no. suffixes for terminal blocks with marking:

0-1-2-3--3-2-1-0	.../021-000
a-b-c-d--d-c-b-a	.../022-000
3-2-1-0--0-1-2-3	.../023-000
d-c-b-a--a-b-c-d	.../024-000

Other terminal blocks with the same profile:

0-1-2-3--3-2-1-0	.../021-000
a-b-c-d--d-c-b-a	.../022-000
3-2-1-0--0-1-2-3	.../023-000
d-c-b-a--a-b-c-d	.../024-000

Accessories; 727 Series Appropriate marking system: WMB

4-level end plate; no marking; 7.62 mm thick

orange	727-217	25
gray	727-213	25

Insulation stop; 0.25 mm² "s"; 0.14 ... 0.25 mm² "f-st"; 8 pcs/strip

light gray	727-198	200 (25)
------------	---------	----------

4-level end plate; Marking: 0-1-2-3--3-2-1-0; 7.62 mm thick

orange	727-205	25
gray	727-255	25

Insulation stop; 0.25 ... 0.5 mm² "s+f-st"; 8 pcs/strip

dark gray	727-199	200 (25)
-----------	---------	----------

4-level end plate; Marking: a-b-c-d--d-c-b-a; 7.62 mm thick

orange	727-206	25
gray	727-256	25

Wire commoning chain; insulated; 32 connections; I_N 6 A; max. 50 V; 0.5 mm²

gray	709-107	1
------	---------	---

4-level end plate; Marking: 3-2-1-0--0-1-2-3; 7.62 mm thick

orange	727-207	25
gray	727-257	25

Step-down test plug; from 4 mm socket to 2 mm plug; max. 42 V

red	210-297	100 (25)
-----	---------	----------

4-level end plate; Marking: d-c-b-a--a-b-c-d; 7.62 mm thick

orange	727-208	25
gray	727-258	25

Wire harness support

gray	249-109	50
------	---------	----

Insulation stop; 0.08 ... 0.2 mm² "s" (0.14 mm² "f-st"); 8 pcs/strip

white	727-197	200 (25)
-------	---------	----------

Double marker carrier; for center I/O module marking; for WSB and WMB marking systems; 4 mm wide

gray	209-128	200 (100)
------	---------	-----------

Accessories; 727 Series
Appropriate marking systems:
WMB

Operating tool with a partially insulated shaft; Type 1; (2.5 x 0.4) mm blade



210-719 1

8-Level Terminal Block for Matrix Patching

1.5 mm²; 727 Series

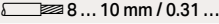
Technical Data	
0.08 ... 1.5 mm ²	28 ... 16 AWG
250 V/4 kV/3 ①	300 V, 10 A ②
I _N 12 A	300 V, 10 A ②
Terminal block width: 7.62 mm / 0.3 inch	
 8 ... 10 mm / 0.31 ... 0.39 inch	

Technical Data	
0.08 ... 1.5 mm ²	28 ... 16 AWG
250 V/4 kV/3 ①	300 V, 10 A ②
I _N 12 A	300 V, 10 A ②
Terminal block width: 7.62 mm / 0.3 inch	
 8 ... 10 mm / 0.31 ... 0.39 inch	

① 250 V = rated voltage
4 kV = rated impulse voltage
3 = pollution degree
(see Section 15)

② Terminal blocks with a blue insulated housing are suitable for Ex i applications.
60 V = peak value ^ (table 4, EN 60079-11 when approved by the manufacturer's authorized inspection representative



See application notes for:
Wire harness support, page 567
Marking, from page 640

Note: Only combine terminal blocks and end plates that are colored **gray/white/light gray** or **orange/blue!**

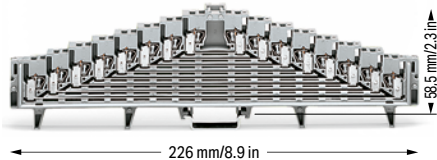
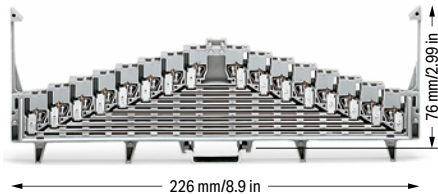

Approvals and corresponding ratings, visit www.wago.com





8-level terminal block for matrix patching; with locking clips; no marking; 8 x pairs of clamping units on the same level; for DIN 35 x 7.5 rail

Color	Item No.	Pack. Unit
 gray	727-119	25
 white	727-121	25
 blue	727-123 ②	25

8-level terminal block for matrix patching; without locking clips; no marking; 8 x pairs of clamping units on the same level; for DIN 35 x 7.5 rail

Color	Item No.	Pack. Unit
 gray	727-120	25
 white	727-122	25
 blue	727-124 ②	25

8-level terminal block for matrix patching; with locking clips; no marking; 8 x pairs of clamping units on the same level; for DIN 35 x 15 rail

Color	Item No.	Pack. Unit
 gray	727-129	25
 white	727-131	25
 blue	727-133 ②	25

8-level terminal block for matrix patching; without locking clips; no marking; 8 x pairs of clamping units on the same level; for DIN 35 x 15 rail

Color	Item No.	Pack. Unit
 gray	727-130	25
 white	727-132	25
 blue	727-134 ②	25

Item no. suffixes for terminal blocks with marking:

0-1-2-3-4-5-6-7--7-6-5-4-3-2-1-0	.../001-000
a-b-c-d-e-f-g-h--h-g-f-e-d-c-b-a	.../002-000
7-6-5-4-3-2-1-0--0-1-2-3-4-5-6-7	.../003-000
h-g-f-e-d-c-b-a--a-b-c-d-e-f-g-h	.../004-000





Other terminal blocks with the same profile:

0-1-2-3-4-5-6-7--7-6-5-4-3-2-1-0	.../001-000
a-b-c-d-e-f-g-h--h-g-f-e-d-c-b-a	.../002-000
7-6-5-4-3-2-1-0--0-1-2-3-4-5-6-7	.../003-000
h-g-f-e-d-c-b-a--a-b-c-d-e-f-g-h	.../004-000





Accessories; 727 Series

Appropriate marking system: WMB





4-level end plate; no marking; 7.62 mm thick

 orange	727-117	25
 gray	727-113	25
 blue	727-114	25
 white	727-115	25
 light gray	727-116	25





4-level end plate; Marking: 7-6-5-4-3-2-1-0--0-1-2-3-4-5-6-7; 7.62 mm thick

 orange	727-107	25
 gray	727-157	25
 blue	727-161	25
 white	727-165	25
 light gray	727-169	25



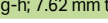

4-level end plate; Marking: 0-1-2-3-4-5-6-7--7-6-5-4-3-2-1-0; 7.62 mm thick

 orange	727-105	25
 gray	727-155	25
 blue	727-159	25
 white	727-163	25
 light gray	727-167	25

4-level end plate; Marking: h-g-f-e-d-c-b-a--a-b-c-d-e-f-g-h; 7.62 mm thick

 orange	727-108	25
 gray	727-158	25
 blue	727-162	25
 white	727-166	25
 light gray	727-170	25

4-level end plate; Marking: a-b-c-d-e-f-g-h--h-g-f-e-d-c-b-a; 7.62 mm thick

 orange	727-106	25
 gray	727-156	25
 blue	727-160	25
 white	727-164	25
 light gray	727-168	25

Insulation stop; 0.08 ... 0.2 mm² "s" (0.14 mm² "f-st"); 8 pcs/strip

 white	727-197	200 (25)
---	---------	----------

Insulation stop; 0.25 mm² "s"; 0.14 ... 0.25 mm² "f-st"; 8 pcs/strip

 light gray	727-198	200 (25)
--	---------	----------

Accessories; 727 Series

Appropriate marking systems:
WMB

Insulation stop; 0.25 ... 0.5 mm² "s+f-st"; 8 pcs/strip

 dark gray	727-199	200 (25)
---	---------	----------

Wire commoning chain; insulated; 32 connections; I_N 6 A; max. 50 V; 0.5 mm²

 gray	709-107	1
--	---------	---

Step-down test plug; from 4 mm socket to 2 mm plug; max. 42 V

 red	210-297	100 (25)
---	---------	----------

Wire harness support

 gray	249-109	50
--	---------	----

Double marker carrier; for center I/O module marking; for WSB and WMB marking systems; 4 mm wide

 gray	209-128	200 (100)
--	---------	-----------

WMB marker card; white; 10 strips with 10 markers/card; for PLC input marking; for 5 ... 17.5 mm terminal block width

 E0.0, E0.1, ..., E9.6, E9.7 (1x each)	793-933	5
---	---------	---

Operating tool with a partially insulated shaft; Type 1; (2.5 x 0.4) mm blade

	210-719	1
---	---------	---

8-Level Common Potential Terminal Block

1.5 mm²; 727 Series

Technical Data	
0.08 ... 1.5 mm ²	28 ... 16 AWG
250 V/4 kV/3 ①	300 V, 10 A ②
I _N 18 A	300 V, 10 A ③
Terminal block width: 7.62 mm / 0.3 inch	
8 ... 10 mm / 0.31 ... 0.39 inch	

Technical Data	
0.08 ... 1.5 mm ²	28 ... 16 AWG
250 V/4 kV/3 ①	300 V, 10 A ②
I _N 18 A	300 V, 10 A ③
Terminal block width: 7.62 mm / 0.3 inch	
8 ... 10 mm / 0.31 ... 0.39 inch	

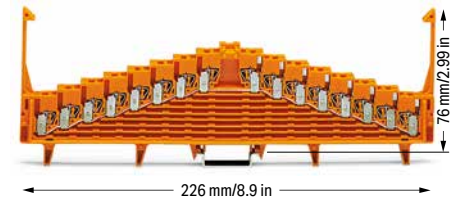

8-level common potential terminal block; with locking clips; no marking; all clamping units connected to the same current bar; for DIN 35 x 7.5 rail

Color	Item No.	Pack. Unit
orange	727-125	25
light gray	727-127	25

8-level terminal block for matrix patching; without locking clips; no marking; all clamping units connected to the same current bar; for DIN 35 x 7.5 rail

Color	Item No.	Pack. Unit
orange	727-126	25
light gray	727-128	25

8-level common potential terminal block; with locking clips; no marking; all clamping units connected to the same current bar; for DIN 35 x 15 rail

orange	727-135	25
light gray	727-137	25

8-level terminal block for matrix patching; without locking clips; no marking; all clamping units connected to the same current bar; for DIN 35 x 15 rail

orange	727-136	25
light gray	727-138	25

Item no. suffixes for terminal blocks with marking:

0-1-2-3-4-5-6-7--7-6-5-4-3-2-1-0	.../001-000
a-b-c-d-e-f-g-h--h-g-f-e-d-c-b-a	.../002-000
7-6-5-4-3-2-1-0--0-1-2-3-4-5-6-7	.../003-000
h-g-f-e-d-c-b-a--a-b-c-d-e-f-g-h	.../004-000

Other terminal blocks with the same profile:

0-1-2-3-4-5-6-7--7-6-5-4-3-2-1-0	.../001-000
a-b-c-d-e-f-g-h--h-g-f-e-d-c-b-a	.../002-000
7-6-5-4-3-2-1-0--0-1-2-3-4-5-6-7	.../003-000
h-g-f-e-d-c-b-a--a-b-c-d-e-f-g-h	.../004-000

Accessories; 727 Series
Appropriate marking system: WMB

4-level end plate; no marking; 7.62 mm thick

orange	727-117	25
gray	727-113	25
blue	727-114	25
white	727-115	25
light gray	727-116	25

4-level end plate; Marking: h-g-f-e-d-c-b-a--a-b-c-d-e-f-g-h; 7.62 mm thick

orange	727-108	25
gray	727-158	25
blue	727-162	25
white	727-166	25
light gray	727-170	25

4-level end plate; Marking: 0-1-2-3-4-5-6-7--7-6-5-4-3-2-1-0; 7.62 mm thick

orange	727-105	25
gray	727-155	25
blue	727-159	25
white	727-163	25
light gray	727-167	25

Insulation stop; 0.08 ... 0.2 mm² "s" (0.14 mm² "f-st"); 8 pcs/strip

white	727-197	200 (25)
-------	---------	----------

4-level end plate; Marking: a-b-c-d-e-f-g-h--h-g-f-e-d-c-b-a; 7.62 mm thick

orange	727-106	25
gray	727-156	25
blue	727-160	25
white	727-164	25
light gray	727-168	25

Insulation stop; 0.25 mm² "s"; 0.14 ... 0.25 mm² "f-st"; 8 pcs/strip

light gray	727-198	200 (25)
------------	---------	----------

4-level end plate; Marking: 7-6-5-4-3-2-1-0--0-1-2-3-4-5-6-7; 7.62 mm thick

orange	727-107	25
gray	727-157	25
blue	727-161	25
white	727-165	25
light gray	727-169	25

Insulation stop; 0.25 ... 0.5 mm² "s+f-st"; 8 pcs/strip

dark gray	727-199	200 (25)
-----------	---------	----------

Wire commoning chain; insulated; 32 connections; I_N 6 A; max. 50 V; 0.5 mm²

gray	709-107	1
------	---------	---

① 250 V = rated voltage
4 kV = rated impulse voltage
3 = pollution degree
(see Section 15)

See application notes for:
Wire harness support, page 567
Marking, from page 640

Note: Only combine terminal blocks and end plates that are colored **gray/white/light gray or orange/blue!**

Approvals and corresponding ratings, visit www.wago.com

Accessories; 727 Series
Appropriate marking systems:
WMB

Step-down test plug; from 4 mm socket to 2 mm plug; max. 42 V

red	210-297	100 (25)
-----	---------	----------

Wire harness support

gray	249-109	50
------	---------	----

Double marker carrier; for center I/O module marking; for WSB and WMB marking systems; 4 mm wide

gray	209-128	200 (100)
------	---------	-----------

Operating tool with a partially insulated shaft; Type 1; (2.5 x 0.4) mm blade

	210-719	1
--	---------	---

Terminal Blocks for Matrix Patching

280 Series

Description and Installation

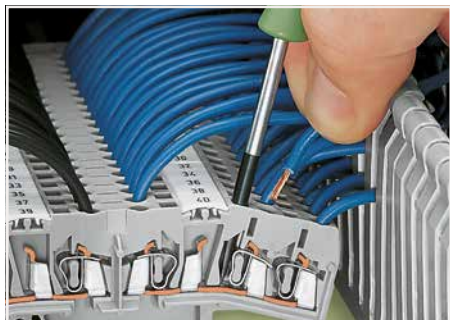

Terminal blocks for matrix patching: Inserting/removing a conductor on the terminal block's side-entry. With ferruled conductors, it is necessary to use a terminal block one size smaller than the conductor's nominal cross section.

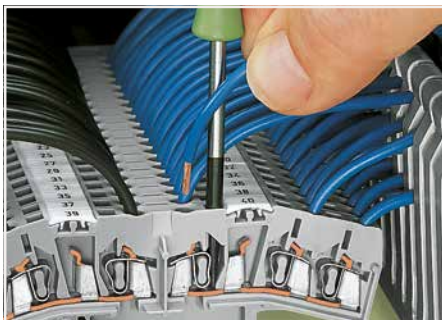

Terminal blocks for matrix patching: Inserting/removing a conductor in the terminal block's center.



Using terminal blocks for matrix patching as disconnect terminal blocks via disconnect jumpers.

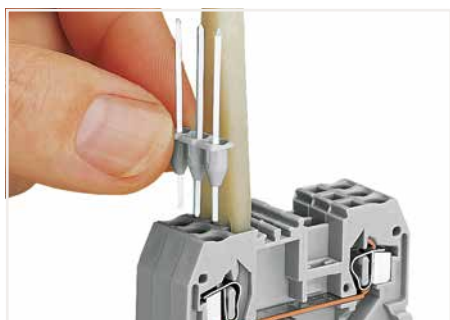

Inserting a pin module into 280 Series blocks.

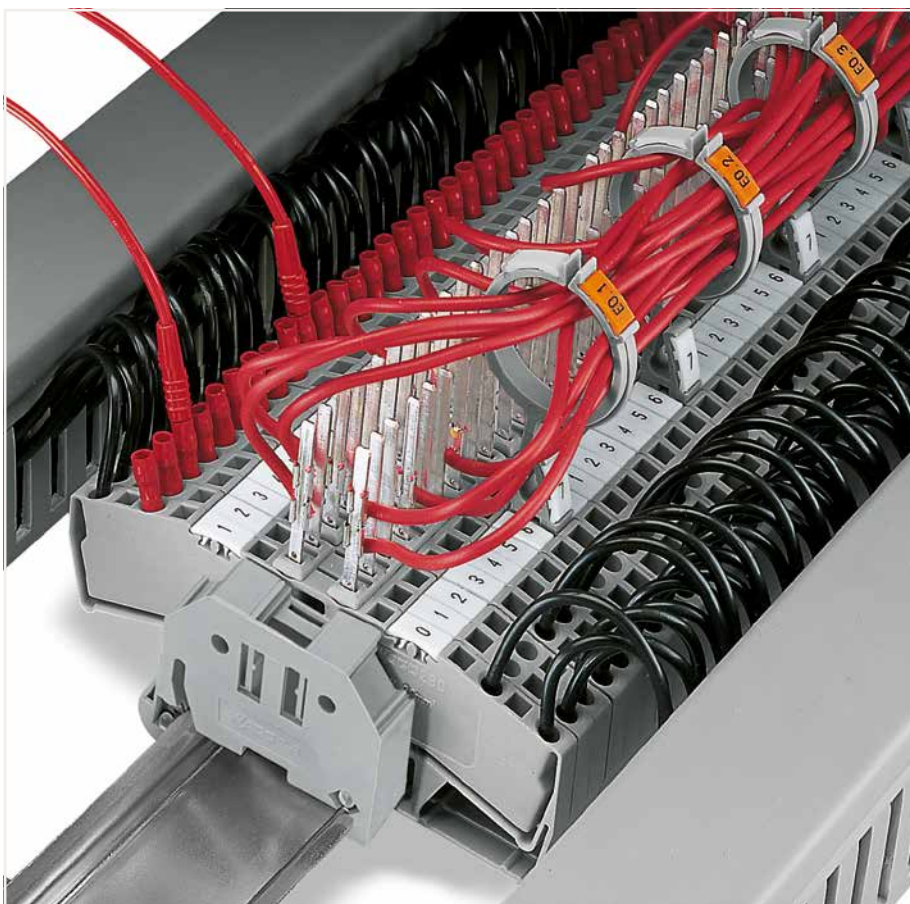

Multiplying potentials via 10-way comb-style jumper bar. (only possible in the terminal block's center)

12



Clipping a wire harness support into the marker slot.



Inserting a cable into the wire harness support.

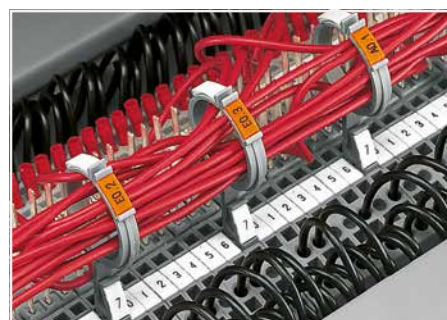

2 x group marking on top
1 x terminal block marking at the bottom

CAGE CLAMP® terminates the following copper conductors:
solid "s" stranded "st"

fine-stranded "f-st", also with tinned single strands

fine-stranded, tip-bonded

fine-stranded, with ferrule (gastight crimped)

fine-stranded, with pin terminal (gastight crimped)

For aluminum conductors, see notes in Section 15. With ferruled conductors, it is necessary to use a terminal block one size smaller than the conductor's nominal cross section.

Terminal Block for Matrix Patching

2.5 mm²; 280 Series

Technical Data

0.08 ... 2.5 mm² | 28 ... 12 AWG*

800 V/8 kV/3 ① | 600 V, 10 A ②

I_N 18 A

Terminal block width: 5 mm / 0.197 inch

 8 ... 9 mm / 0.31 ... 0.35 inch

93 mm/3.66 in

3-conductor double-potential terminal block or terminal block for matrix patching

Notice: This 3-conductor double-potential terminal block cannot be commoned via adjacent jumpers.

Color	Item No.	Pack. Unit
○ gray	280-675	100

Accessories; for Terminal Blocks for Matrix Patching

Appropriate marking systems:
WMB/WMB Inline

End and intermediate plate; 25 mm thick

	orange	280-333	25
	gray	280-325	25

Separator; 3 mm oversized; 1 mm thick

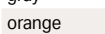
	gray	280-394	100 (25)
	orange	280-395	100 (25)

Insulation stop; 0.08 ... 0.2 mm² "s" (0.14 mm² "f-st"); 5 pcs/strip

	white	280-470	200 (25)
---	-------	---------	----------

Insulation stop; 0.25 ... 0.5 mm²; 5 pcs/strip

	light gray	280-471	200 (25)
---	------------	---------	----------



Insulation stop; 0.75 ... 1 mm²; 5 pcs/strip

	dark gray	280-472	200 (25)
---	-----------	---------	----------

Protective warning marker; with black high-voltage symbol; for 5 terminal blocks

	yellow	280-415	100 (25)
---	--------	---------	----------

Comb-style jumper bar; insulated; I_N = I_N of terminal block

	2-way	280-482	200 (25)
	3-way	280-483	200 (25)

Comb-style jumper bar; insulated; I_N = I_N of terminal block

	10-way	280-490	50 (25)
---	--------	---------	---------

Disconnect jumper; with pull-tab; I_N = I_N of terminal block; orange

	2-way	280-494	200 (25)
---	-------	---------	----------

*12 AWG: THHN, THWN



- ① 800 V = rated voltage
8 kV = rated impulse voltage
3 = pollution degree (see Section 15)
500 V/6 kV/3 between both current bars (if used as disconnect terminal block or potential multiplier)

See application notes for:
Insulation stop, page 382
Comb-style jumper bar, page 384
Marking, from page 640Approvals and corresponding ratings, visit www.wago.com

Accessories; for Terminal Blocks for Matrix Patching

Appropriate marking systems:
WMB/WMB Inline

Operating tool; insulated

	2-way	280-432	1
	3-way	280-433	1

Operating tool; insulated

	10-way	280-440	1
---	--------	---------	---

Pin module; 0.8 x 2.4 mm; for self-assembly on all front-entry rail-mount terminal blocks (280 Series); for termi-point connection; 2-pole

		280-473	100
---	--	---------	-----

Pin module; 0.8 x 2.4 mm; for self-assembly on all front-entry rail-mount terminal blocks (280 Series); for termi-point connection; 3-pole

		280-474	100
---	--	---------	-----

Wire harness support

	gray	249-109	50
---	------	---------	----

In measurement and control technology, matrix patchboards are essential for process automation systems. Particularly beneficial to these applications is the use of the WAGO wire harness support, which simplifies wiring. WAGO's 280 Series 3-Conductor Double-Potential Terminal Blocks (with or without the addition of Wire-Wrap® or TERMI-POINT® pins) are also ideal for this type of application. They can be used for connecting peripheral field devices (e.g. measuring and control equipment) to process control systems (e.g., panels, cabinets) via matrix connections.

The WAGO wire harness supports are pushed into the terminal blocks (approx. every 8th unit) to form an additional "cable-duct" above the wiring level of the terminal blocks. The two marker slots on the top may be used for group marking, while the lower slot is used for marking the terminal block.

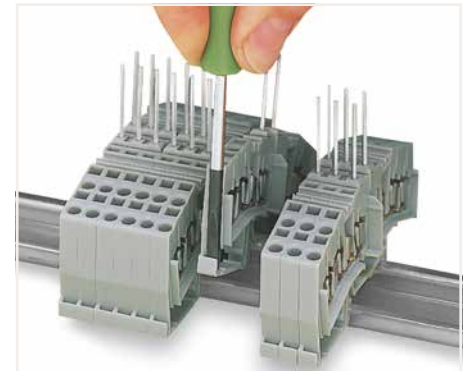

Please note that due to the protruding rods, the terminal blocks can only be inserted or removed from the assembly after sliding adjacent terminal blocks on the rail. Removal: Separate terminal strip, slide terminal block to disconnect and then remove from the DIN-rail.

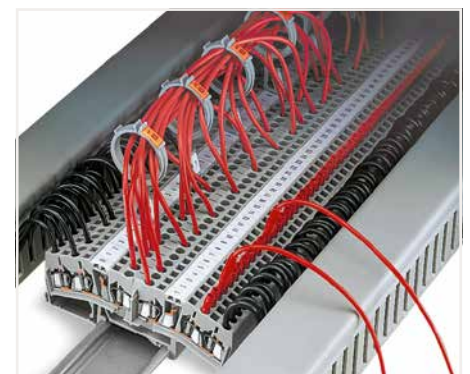

Terminal blocks for matrix patching with wire harness supports:

For 5 mm wide double-potential terminal blocks, two 3-conductor through terminal blocks are offered in one insulating housing on one level. This achieves a width of just 2.5 mm versus standard through terminal blocks. On each side of the terminal block are marker slots for WAGO WMB Inline markers. Via the available accessories, these terminal blocks can also be used as 4-conductor disconnect terminal blocks or potential multipliers.

The WAGO wire harness supports are pushed into the terminal blocks (approx. every 8th unit) to form an additional "cable-duct" above the wiring level of the terminal blocks. The two marker slots on the top may be used for group marking, while the lower slot is used for marking the terminal block.



Separator for 3-conductor, double-potential terminal blocks (280-675)

Busbar Terminal Block

4 mm² and 16 mm²; 812 Series

Technical Data	
0.5 ... 4 mm ²	20 ... 12 AWG
1000 V/6 kV/3	600 V, 20 A
I _N 96 A	600 V, 95 A
Terminal block width: 75 mm / 2.953 inch	
11 mm / 0.43 inch	

Technical Data	
1.5 ... 16 mm ²	14 ... 6 AWG
1000 V/6 kV/3	600 V, 20 A
I _N 96 A	600 V, 95 A
Terminal block width: 38 mm / 1.496 inch	
12 mm / 0.47 inch	

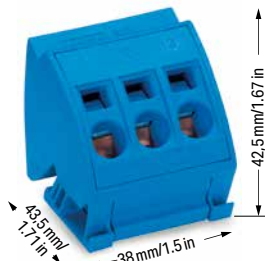

Busbar terminal block 4 mm ² ; with Push-in CAGE CLAMP® connection		
Color	Item No.	Pack. Unit
blue	812-104	10
light gray	812-101	10
dark gray	812-102	10
red	812-103	10

Busbar terminal block 16 mm ² ; with CAGE CLAMP® connection		
Color	Item No.	Pack. Unit
blue	812-114	12
light gray	812-111	12
dark gray	812-112	12
red	812-113	12

Insulated busbar carrier; 12 mm wide		
Color	Item No.	Pack. Unit
gray	812-140	25

Accessories; item-specific			
Busbar; tin-plated; 1000 mm long; Copper (10 x 3) mm			
I _N	Item No.	Pack. Unit	
140 A	210-133	1	

Accessories; item-specific			
Busbar; tin-plated; 1000 mm long; Copper (10 x 3) mm			
I _N	Item No.	Pack. Unit	
140 A	210-133	1	

Finger guard; touch-proof cover protects unused conductor entries			
Color	Item No.	Pack. Unit	
yellow	284-400	100 (25)	

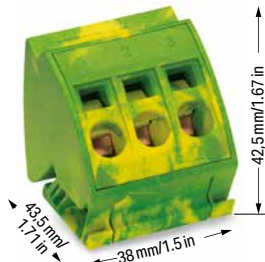
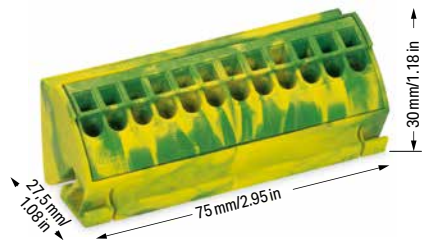

Ground busbar terminal block 4 mm ² ; with Push-in CAGE CLAMP® connection		
Color	Item No.	Pack. Unit
green-yellow	812-100	10

Ground busbar terminal block 16 mm ² ; with CAGE CLAMP® connection		
Color	Item No.	Pack. Unit
green-yellow	812-110	12

Ground busbar carrier; with DIN-35 rail contact; 11 mm wide		
Color	Item No.	Pack. Unit
green-yellow	812-141	25

Accessories; item-specific			
Busbar; tin-plated; 1000 mm long; Copper (10 x 3) mm			
I _N	Item No.	Pack. Unit	
140 A	210-133	1	

Accessories; item-specific			
Busbar; tin-plated; 1000 mm long; Copper (10 x 3) mm			
I _N	Item No.	Pack. Unit	
140 A	210-133	1	













Finger guard; touch-proof cover protects unused conductor entries			
Color	Item No.	Pack. Unit	
yellow	284-400	100 (25)	



WAGO Splicing Connectors
WAGO Lighting Connectors

WAGO Splicing Connectors

WAGO Lighting Connectors

			Page
	COMPACT PUSH WIRE® Connectors for Junction Boxes 2.5 mm ² (14 AWG)	2273 Series	573
	PUSH WIRE® Connectors for Junction Boxes 4 mm ² and 6 mm ² (10 AWG)	773 Series	576
	Ex PUSH WIRE® Connectors for Junction Boxes 2.5 mm ² (12 AWG) and 6 mm ² (10 AWG)	773 Series	578
	MICRO PUSH WIRE® Connectors for Junction Boxes 0.8 mm Ø	243 Series	582
	COMPACT Splicing Connectors for All Conductor Types 4 mm ² and 6 mm ² (10 AWG)	221 Series	585
	COMPACT Splicing Connector for All Conductor Types; for Ex eb Applications 4 mm ² and 6 mm ² (10 AWG)	221 Series	594
	Yellowox; for Splicing Connectors	Serie 207	599
	Inline Splicing Connectors 4 mm ² (14 AWG)	221 Series	605
	CLASSIC Splicing Connectors for All Conductor Types 2.5 mm ² (14 AWG)	222 Series	609
	Lighting Connectors 2.5 mm ² (14 AWG)	224 Series	613
	Connector Sets	887 Series	614
	Luminaire Disconnect Connectors 12 AWG	873 Series	618

COMPACT Splicing Connectors for Solid Conductors

2273 Series

Description and Installation



Advantages:

- Convenient wiring via extremely compact design
- Push-in termination of up to eight solid conductors
- Cross section range: 0.5 ... 2.5 mm² (18 ... 14 AWG)
- Any combination of conductor sizes is possible
- PUSH WIRE® connection terminates solid ("s") copper conductors



Strip solid conductor to 11 mm/0.43 inch (see marking).

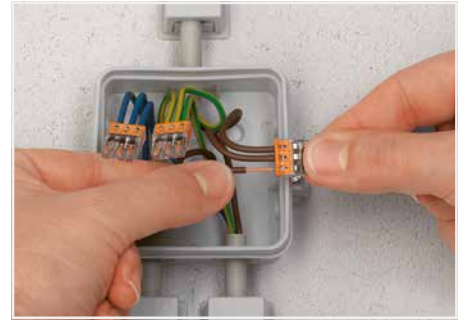

Termination: Insert the stripped solid conductor until it hits backstop.

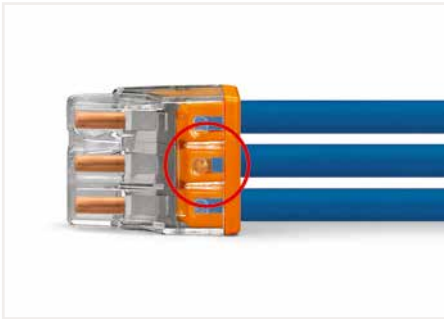

The transparent housing shows if conductors are fully inserted; within the colored base, a clear port shows if the conductor's strip length is correct. Conductors are correctly stripped if the clear port shows no bare conductor on the unprinted connector side. Picture shows center conductor with exceeded strip length.



Removal: Hold conductor to be removed and twist alternately left and right while pulling the connector.



Testing via test port opposite to conductor entry.

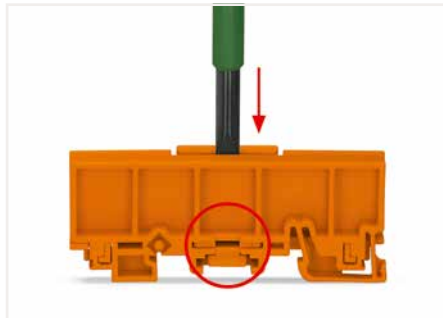

One single carrier can hold up to 24 clamping units in a very narrow space. Previously, this was only possible using rail-mount terminal blocks.

Advantages:

- Mount carrier onto DIN-35 rail or via screws – easily and quickly
- Accommodate three 2.5 mm² (12 AWG) 2273 Series Connectors in a single carrier
- Easily exchange connectors
- Large marking area for self-adhesive marking strips or for direct marking with permanent felt-tip pen

PUSH WIRE® Connectors in Distribution Boxes

During distribution box retrofits or expansions, conductors often require extensions or additional clamping points. Individual PUSH WIRE® connectors (e.g., 2273 Series) are approved as interconnect components for building wiring applications per EN 60998. Application standards for building installation (e.g., Parts 510 and 520 from DIN VDE 0100) also place the following requirements on junction box connectors:

- They must be arranged so that operation, inspection, maintenance and access to the removable connectors is simplified.
- It must be possible to test them.
- Conductors connected from outside must be clearly and permanently assigned to their associated circuits.



To adjust the mounting carrier, unlock the latch via operating tool (5.5 mm blade) and move the clamping slide to the required width by rotating the tool.



The mounting carrier is suitable for both connector widths.

These requirements cannot be met with PUSH WIRE® connectors alone. In combination with mounting carriers, the PUSH WIRE® connectors clearly meet these requirements, making them comparable to rail-mount terminal blocks. Using PUSH WIRE® connectors with mounting carriers in distribution boxes is accepted by testing authorities.



PUSH WIRE® terminates the following copper conductors: solid "s"

COMPACT Splicing Connector for Solid Conductors and Mounting Carrier

2.5 mm²; 2273 Series

Technical Data	
0.5 ... 2.5 mm ² "s"	20 ... 16 AWG "s"
450 V/4 kV/2	600 V, 20 A [Ⓢ]
I _N 24 A	
□ 11 mm / 0.43 inch	

Technical Data	
0.5 ... 2.5 mm ² "s"	20 ... 16 AWG "s"
450 V/4 kV/2	600 V, 20 A [Ⓢ]
I _N 24 A	
□ 11 mm / 0.43 inch	

Technical Data	
0.5 ... 2.5 mm ² "s"	20 ... 16 AWG "s"
450 V/4 kV/2	600 V, 20 A [Ⓢ]
I _N 24 A	
□ 11 mm / 0.43 inch	



Dimensions in mm

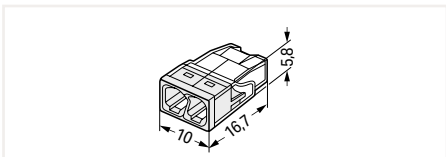

COMPACT splicing connector; 2-wire connector; transparent housing; white cover; continuous operating temperature (max.): 105 °C; surrounding air temperature (max.): 60 °C (T60)

Item No.	Pack. Unit
2273-202	1000 (100)

Dimensions in mm

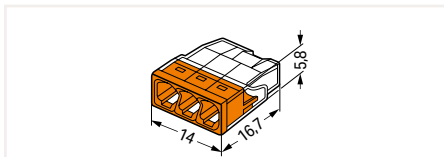

COMPACT splicing connector; 3-wire connector; transparent housing; orange cover; continuous operating temperature (max.): 105 °C; surrounding air temperature (max.): 60 °C (T60)

Item No.	Pack. Unit
2273-203	1000 (100)

Dimensions in mm

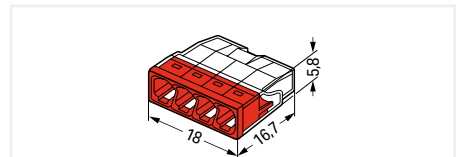

COMPACT splicing connector; 4-wire connector; transparent housing; red cover; continuous operating temperature (max.): 105 °C; surrounding air temperature (max.): 60 °C (T60)

Item No.	Pack. Unit
2273-204	1000 (100)



Dimensions in mm

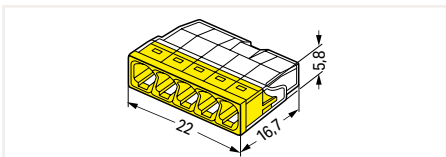

COMPACT splicing connector; 5-wire connector; transparent housing; yellow cover; continuous operating temperature (max.): 105 °C; surrounding air temperature (max.): 60 °C (T60)

Item No.	Pack. Unit
2273-205	1000 (100)

Dimensions in mm

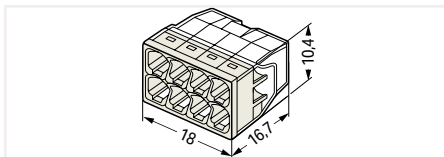

COMPACT splicing connector; 8-wire connector; transparent housing; light gray cover; continuous operating temperature (max.): 105 °C; surrounding air temperature (max.): 60 °C (T60)

Item No.	Pack. Unit
2273-208	500 (50)

Mounting carrier; for single- and double-row connectors

	Item No.	Pack. Unit
● orange	2273-500	50 (10)

Accessories; item-specific

Marking strip; 5 mm high; 48 self-adhesive strips per card; plain

	Item No.	Pack. Unit
□ white	210-334	100

Accessories; 2273 Series

Syringe; contains 20 ml "Alu-Plus" Contact Paste

	Item No.	Pack. Unit
	249-130	20 (5)

PUSH WIRE® Connectors for Junction Boxes

773 Series

Description and Installation

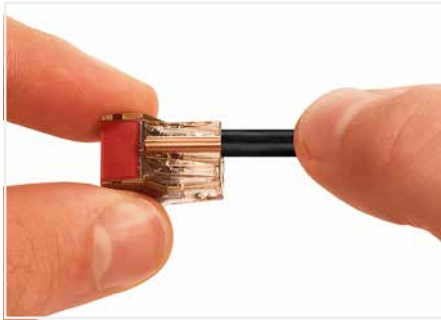
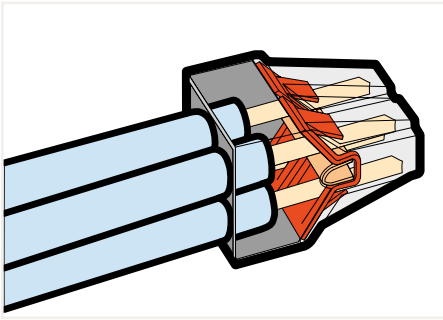

Strip a solid conductor to 12 mm (0.47 inch).



Termination: Insert stripped solid conductor until it hits backstop.



Removal: Hold conductor to be removed and twist alternately left and right while pulling the connector.



Testing



13



PUSH WIRE®
terminates the following
copper conductors:
solid "s"

Mounting Carrier; for PUSH WIRE® Junction Box Connectors; for DIN-35 Rail or Screw Mount 773 Series

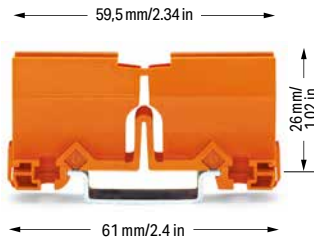

Use the cover as an end plate.

Mounting carrier; for all 773 Series PUSH WIRE® Connectors for Junction Boxes

Color	Item No.	Pack. Unit
orange	773-332	50 (10)

Accessories; item-specific

Marking strip; 5 mm high; 48 self-adhesive strips per card; plain

Color	Item No.	Pack. Unit
white	210-334	100



Snap the mounting carrier onto the DIN-rail.

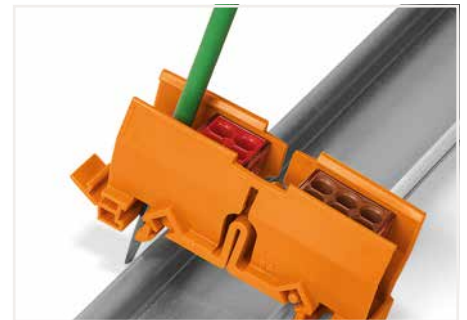

Remove the mounting carrier from the DIN-rail.



A mounting carrier (see accessories) suits applications where the connectors must be marked and secured in position. The DIN-35 rail-mount carrier fits up to six connectors and can also be mounted on a flat surface using two screws.

Using this PUSH WIRE® connector, a large range of wiring applications can be achieved in distribution or junction boxes. To mention just a few: potential multiplication and changing from or to 6 mm² (10 AWG) conductor size.

PUSH WIRE® Junction Box Connector for Solid Conductors 4 mm²; 773 Series

Technical Data
1.5 ... 4 mm ² "s"
400 V/4 kV/2 ①
I _N 32 A
12 mm / 0.47 inch

Technical Data
1.5 ... 4 mm ² "s"
400 V/4 kV/2 ①
I _N 32 A
12 mm / 0.47 inch

Technical Data
1.5 ... 4 mm ² "s"
400 V/4 kV/2 ①
I _N 32 A
12 mm / 0.47 inch



Dimensions in mm

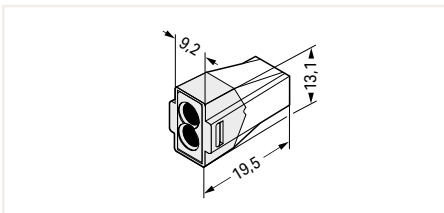

PUSH WIRE® junction box connector for solid conductors up to 4 mm²; 2-wire connector; transparent brown housing; white cover; continuous operating temperature (max.): 105 °C; surrounding air temperature (max.): 60 °C (T60)

Item No.	Pack. Unit
773-602	1000 (100)

Dimensions in mm

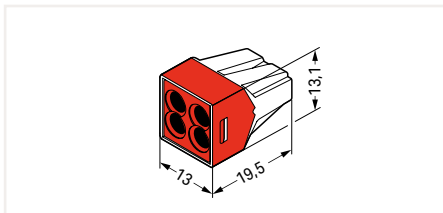

PUSH WIRE® junction box connector for solid conductors up to 4 mm²; 4-wire connector; transparent brown housing; red cover; continuous operating temperature (max.): 105 °C; surrounding air temperature (max.): 60 °C (T60)

Item No.	Pack. Unit
773-604	1000 (100)

Dimensions in mm

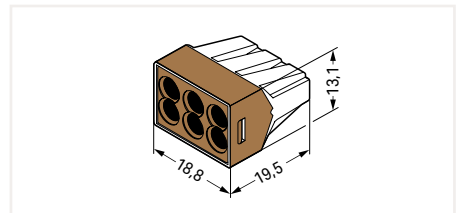

PUSH WIRE® junction box connector for solid conductors up to 4 mm²; 6-wire connector; transparent brown housing; brown cover; continuous operating temperature (max.): 105 °C; surrounding air temperature (max.): 60 °C (T60)

Item No.	Pack. Unit
773-606	500 (50)

Accessories; 773 Series

Syringe; contains 20 ml "Alu-Plus" Contact Paste

	249-130	20 (5)
--	---------	--------

Mounting carrier; for single- and double-row connectors

	orange	773-332	50 (10)
---	--------	---------	---------

PUSH WIRE® Connector for Junction Boxes

2.5 mm² and 6 mm²; 773 Series

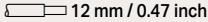
Technical Data	
0.75 ... 2.5 mm ² "s"	18 ... 12 AWG "s"
1.5 ... 2.5 mm ² "st"	16 ... 12 AWG "st"
400 V/4 kV/2 ①	600 V, 20 AⓈ
I _N 24 A	600 V, 20 AⓈ
 12 mm / 0.47 inch	

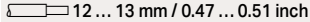
Technical Data	
2.5 ... 6 mm ² "s+st"	14 ... 10 AWG "s+st"
400 V/4 kV/2 ①	600 V, 30 AⓈ
I _N 41 A	600 V, 30 AⓈ
 12 ... 13 mm / 0.47 ... 0.51 inch	

- ① In grounded power lines
 400 V = rated voltage
 4 kV = rated impulse voltage
 2 = pollution degree
 (see Section 15)

Approvals and corresponding ratings, visit www.wago.com



Dimensions in mm

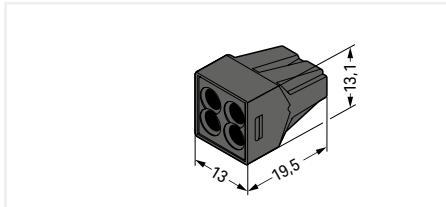

PUSH WIRE® connector for junction boxes; 4-wire connector; continuous operating temperature: 105 °C; surrounding air temperature (max.): 105 °C

Color	Item No.	Pack. Unit
● black	773-514	1000 (100)

Dimensions in mm

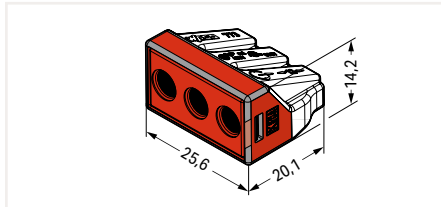

PUSH WIRE® connector for junction boxes; 3-wire connector; transparent housing; red cover; continuous operating temperature (max.): 105 °C; surrounding air temperature (max.): 60 °C

Color	Item No.	Pack. Unit
● red	773-173	500 (50)

Accessories; 773 Series

Syringe; contains 20 ml "Alu-Plus" Contact Paste

249-130 20 (5)



PUSH WIRE® Connectors in Distribution Boxes

During distribution box retrofits or expansions, conductors often require extensions or additional clamping points. Individual PUSH WIRE® connectors (e.g., 773 Series) are approved as interconnect components for building wiring applications per EN 60998. Application standards for building installation (e.g., Parts 510 and 520 from DIN VDE 0100) also place the following requirements on junction box connectors:

- They must be arranged so that operation, inspection, maintenance and access to the removable connectors is simplified.
- It must be possible to test them.
- Conductors connected from outside must be clearly and permanently assigned to their associated circuits.

These requirements cannot be met with PUSH WIRE® connectors alone. In combination with mounting carriers, the PUSH WIRE® connectors clearly meet these requirements, making them comparable to rail-mount terminal blocks. Using PUSH WIRE® connectors with mounting carriers in distribution boxes is accepted by testing authorities.

Ex PUSH WIRE® Connector for Junction Boxes 2.5 mm² and 6 mm²; 773 Series

Technical Data	
0.75 ... 2.5 mm ² "s"	18 ... 14 AWG "s" 16 ... 12 AWG "st"
550 V ⓘ	
I _N 24 A	
 12 mm / 0.47 inch	

Technical Data	
0.75 ... 2.5 mm ² "s"	18 ... 14 AWG "s" 16 ... 12 AWG "st"
550 V ⓘ	
I _N 24 A	
 12 mm / 0.47 inch	

Technical Data	
2.5 ... 6 mm ² "s"	14 ... 10 AWG "s"
550 V ⓘ	
I _N 42 A	
 12 ... 15 mm / 0.47 ... 0.59 inch	



Dimensions in mm

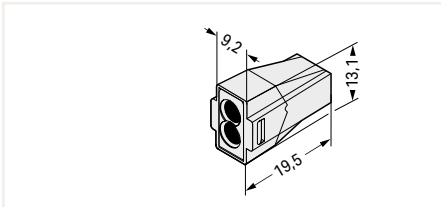

Dimensions in mm

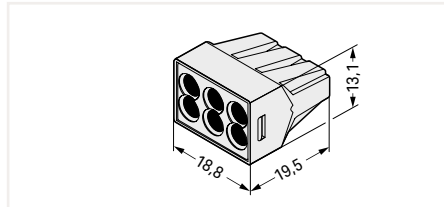

Dimensions in mm

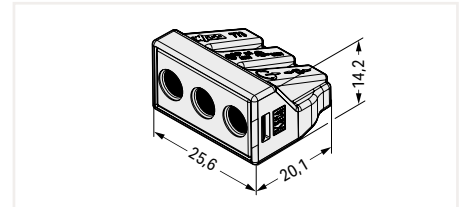

PUSH WIRE® connector for junction boxes; 2-wire connector

Color	Item No.	Pack. Unit
○ light gray ⊕	773-492 Ⓜ	1000 (100)

PUSH WIRE® connector for junction boxes; 6-wire connector

Color	Item No.	Pack. Unit
○ light gray ⊕	773-496 Ⓜ	500 (50)

PUSH WIRE® connector for junction boxes; 3-wire connector

Color	Item No.	Pack. Unit
○ light gray ⊕	773-493 Ⓜ	500 (50)



Dimensions in mm

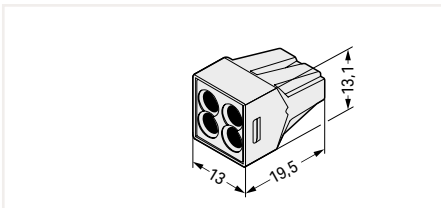

Dimensions in mm

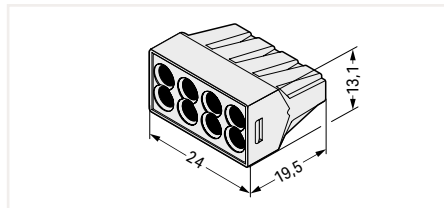

PUSH WIRE® connector for junction boxes; 4-wire connector

Color	Item No.	Pack. Unit
○ light gray ⊕	773-494 Ⓜ	1000 (100)

PUSH WIRE® connector for junction boxes; 8-wire connector

Color	Item No.	Pack. Unit
○ light gray ⊕	773-498 Ⓜ	500 (50)

13

Mounting Carrier; for Ex PUSH WIRE® Junction Box Connectors; for DIN-35 Rail or Screw Mount 773 Series

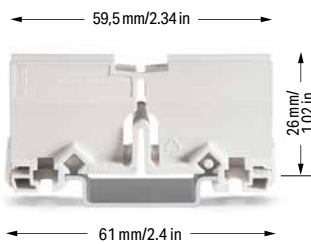

Mounting carrier; for Ex PUSH WIRE® junction box connectors

Color	Item No.	Pack. Unit
○ light gray ☺	773-331	50 (10)

Accessories; item-specific

Marking strip; 5 mm high; 48 self-adhesive strips per card; plain

Color	Item No.	Pack. Unit
white	210-334	100



- 1 275 V at a distance < 10 mm to parts of other potentials
 - 2 To be used only in conjunction with a mounting carrier (773-331)
- Approvals and corresponding ratings, visit www.wago.com

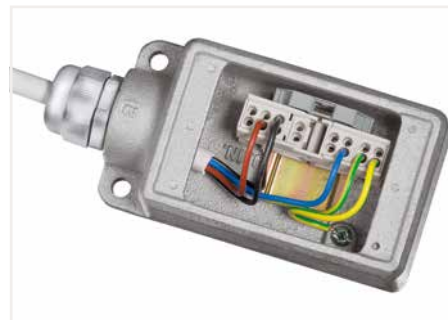

Wiring example in an Ex junction box



Insert the connectors into the carrier.

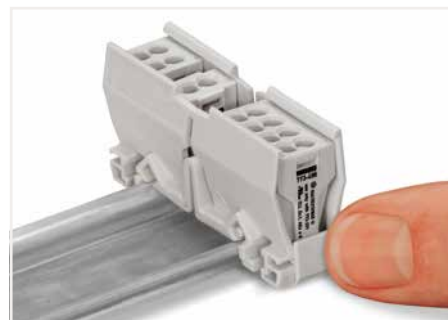

Use the cover as an end plate.



Snap the mounting carrier onto the DIN-rail.



Remove the mounting carrier from the DIN-rail.

Ex PUSH WIRE® connectors are ideal for distribution and junction boxes, as well as control and operating systems. When used in hazardous areas, they offer the following advantages over traditional connectors:

- Time- and cost-saving PUSH WIRE® connection
- Vibration-proof, maintenance-free connections
- 100% touch-proof protection
- Connectors can be secured in position via mounting carriers
- One single carrier equipped with 2-, 4-, 6- and 8-wire connectors holds up to 16 clamping units according to user requirements, saving materials and related costs
- Available as OEM products for manufacturers and suppliers of enclosures and distribution boxes used in hazardous areas

MICRO PUSH WIRE® Junction Box Connectors for Solid Conductors

243 Series

Description and Installation

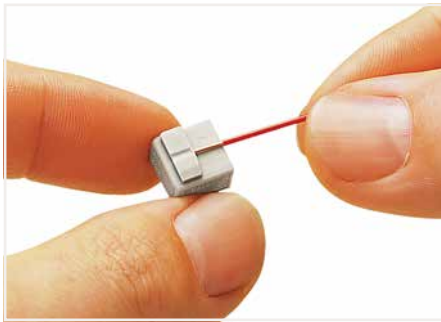
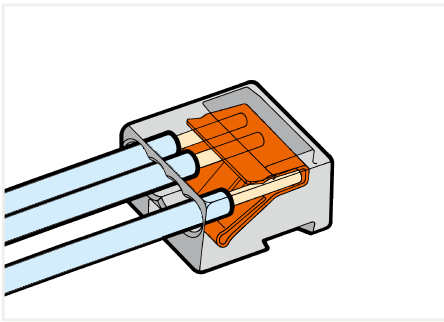

Strip solid conductors to 5 ... 6 mm (0.19 ... 0.23 inch).



Connector strips:
Assembling modular connectors into connector strips.

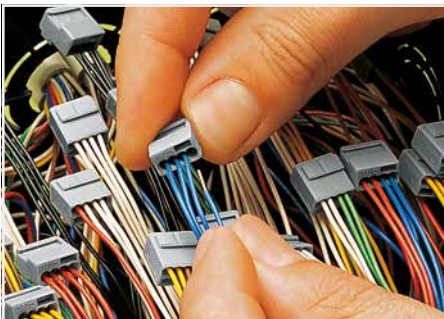

Termination: Insert stripped conductor until it hits back-stop.

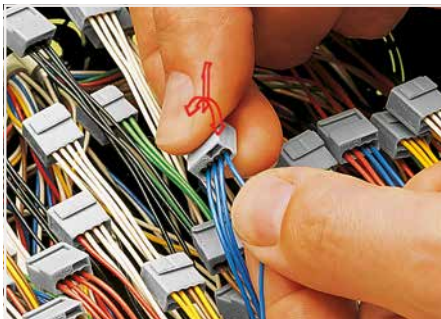

Removal: Hold conductor to be removed and twist alternately left and right while pulling the connector.



Testing

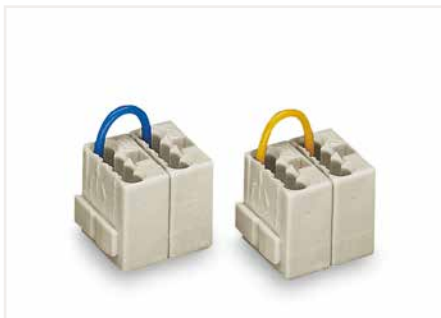

Commoned connector strips



PUSH WIRE®
terminates the following
copper conductors:
solid "s"

Mounting Carrier; for MICRO PUSH WIRE® Junction Box Connectors; for DIN-35 Rail or Screw Mount 243 Series

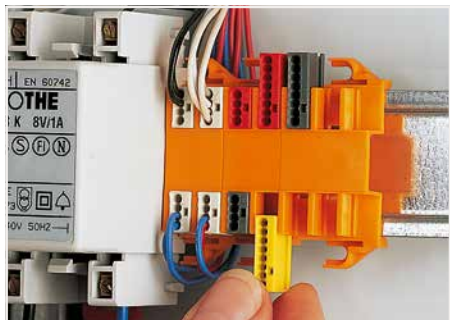

Inserting a MICRO junction box connector into the mounting carrier.

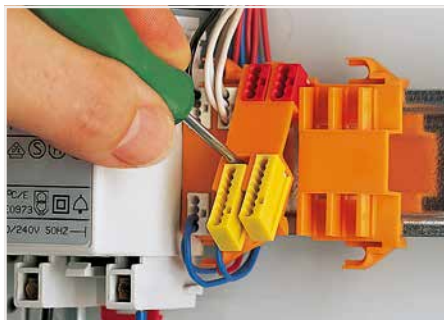

Removing a mounting carrier from the assembly.



Example of a residential door bell application – carriers mounted on a DIN-35 rail

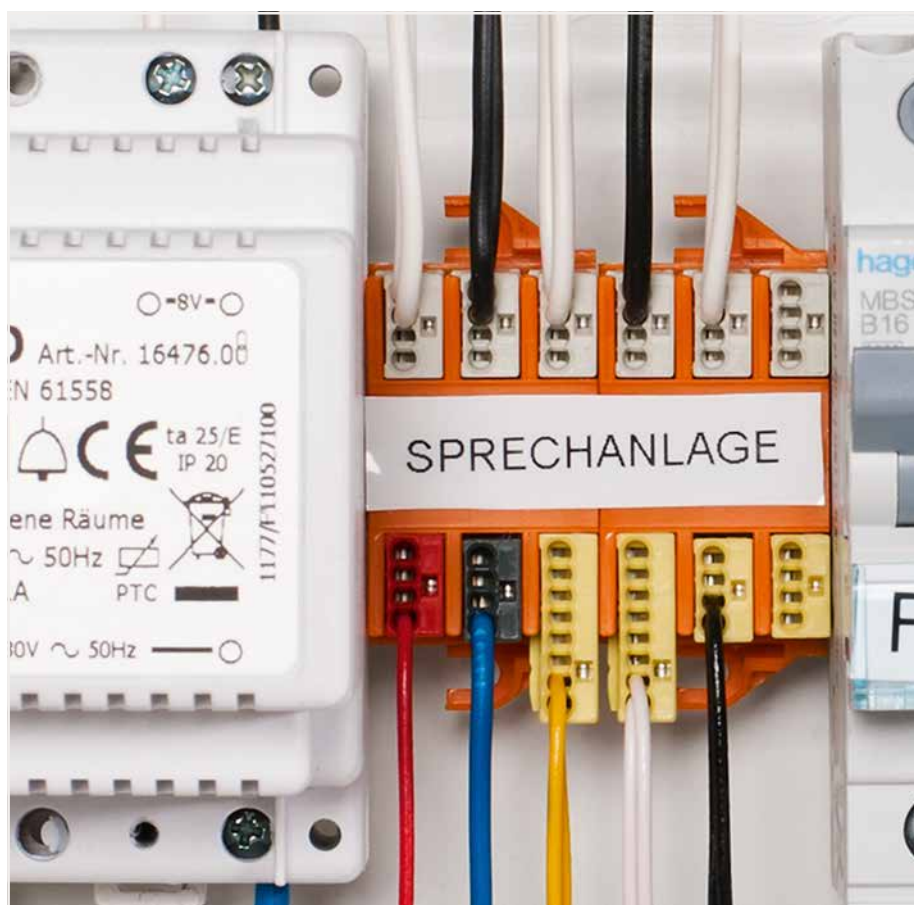

Example of a residential intercom application

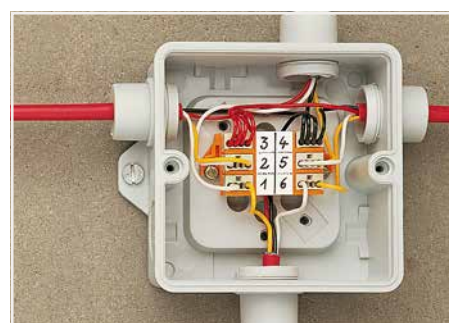

Typical application in a terminal box for burglar alarm – screw-mounted carrier

Quick Fix Mounting

Realizing MICRO PUSH WIRE® connectors for junction boxes are ideal for DIN-rail-mount panel applications, electrical installers have requested the ability to use them in distribution panels. These connectors provide easy connections for smaller conductors used in low-current applications. They are well-suited to terminating telephone-style conductors for connecting alarms, bells, door sensors, communication systems, etc.

The mounting carrier is WAGO's professional solution. It is available with mounting slots for 4 or 6 connectors.

Depending on the number of conductors, each mounting slot can accommodate a 4- or 8-conductor MICRO PUSH WIRE® junction box connector. The connectors simply snap into the mounting slots and are removable, allowing conductors to be exchanged during changeover.

The carrier is designed for easy mounting directly to the DIN-35 rail, or to a panel, via the screw-mount flanges provided on both sides. A large marking area for direct marking with a permanent felt-tip pen or for pre-printed self-adhesive marking strips is provided for clear circuit identification.

MICRO PUSH WIRE® Connector for Junction Boxes Ø 0.8 mm and Ø 0.5 mm; 243 Series

Technical Data

0.6 ... 0.8 mm Ø "s" ①	22 ... 20 AWG "s"
100 V/1.5 kV/2 ②	150 V, 7 A ③
I _N 6 A	150 V, 7 A ④
5 ... 6 mm / 0.2 ... 0.24 inch	

Technical Data

0.6 ... 0.8 mm Ø "s" ①	22 ... 20 AWG "s"
100 V/1.5 kV/2 ②	150 V, 7 A ③
I _N 6 A	150 V, 7 A ④
5 ... 6 mm / 0.2 ... 0.24 inch	

Technical Data

0.4 ... 0.5 mm Ø "s"	26 ... 24 AWG "s"
100 V/1.5 kV/2 ②	150 V, 7 A ③
I _N 6 A	150 V, 7 A ④
5 ... 6 mm / 0.2 ... 0.24 inch	



Dimensions in mm

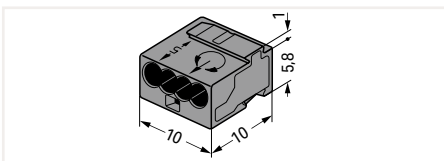

Dimensions in mm

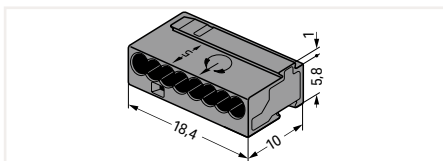

Dimensions in mm

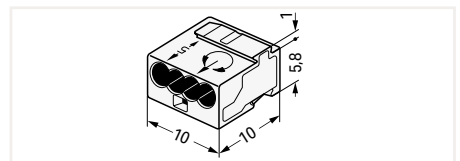

MICRO PUSH WIRE® connector for junction boxes; 4-wire connector; continuous operating temperature (max.): 105 °C; surrounding air temperature (max.): 60 °C

Color	Item No.	Pack. Unit
dark gray	243-204	1000 (100)
red	243-804	1000 (100)

MICRO PUSH WIRE® connector for junction boxes; 8-wire connector; continuous operating temperature (max.): 105 °C; surrounding air temperature (max.): 60 °C

Color	Item No.	Pack. Unit
dark gray	243-208	500 (50)
red	243-808	500 (50)

MICRO PUSH WIRE® connector for junction boxes; 4-wire connector; continuous operating temperature (max.): 105 °C; surrounding air temperature (max.): 60 °C

Color	Item No.	Pack. Unit
transparent	243-144	1000 (100)



Dimensions in mm

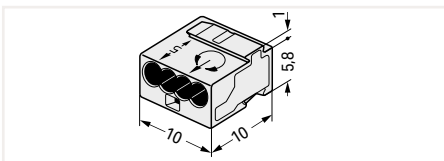

Dimensions in mm

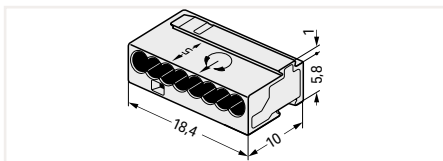

MICRO PUSH WIRE® connector for junction boxes; 4-wire connector; continuous operating temperature (max.): 105 °C; surrounding air temperature (max.): 60 °C

Color	Item No.	Pack. Unit
light gray	243-304	1000 (100)
yellow	243-504	1000 (100)

MICRO PUSH WIRE® connector for junction boxes; 8-wire connector; continuous operating temperature (max.): 105 °C; surrounding air temperature (max.): 60 °C

Color	Item No.	Pack. Unit
light gray	243-308	500 (50)
yellow	243-508	500 (50)

13

Mounting Carrier; for MICRO PUSH WIRE® Junction Box Connectors; for DIN-35 Rail or Screw Mount

243 Series



① When using conductors of the same diameter, 0.5 mm (24 AWG) or 1 mm (18 AWG) diameters are also possible.

② 100 V = rated voltage
1.5 kV = rated impulse voltage
2 = pollution degree (see Section 15)

Approvals and corresponding ratings, visit www.wago.com

Quick Fix Mounting

Realizing MICRO PUSH WIRE® connectors for junction boxes are ideal for DIN-rail-mount panel applications, electrical installers have requested the ability to use them in distribution panels. These connectors provide easy connections for smaller conductors used in low-current applications. They are well-suited to terminating telephone-style conductors for connecting alarms, bells, door sensors, communication systems, etc.

The mounting carrier is WAGO's professional solution. It is available with mounting slots for 4 or 6 connectors.

Depending on the number of conductors, each mounting slot can accommodate a 4- or 8-conductor MICRO PUSH WIRE® junction box connector. The connectors simply snap into the mounting slots and are removable, allowing conductors to be exchanged during changeover.

The carrier is designed for easy mounting directly to the DIN-35 rail, or to a panel, via the screw-mount flanges provided on both sides. A large marking area for direct marking with a permanent felt-tip pen or for pre-printed self-adhesive marking strips is provided for clear circuit identification.



Mounting carrier; for 4 connectors

Color	Item No.	Pack. Unit
orange	243-112	50 (10)

Accessories

Marking strip; 7 mm high; 6 self-adhesive strips per card; plain

	white	243-110	100
---	-------	---------	-----



Mounting carrier; for 6 connectors

Color	Item No.	Pack. Unit
orange	243-113	50 (10)

Accessories

Marking strip; 7 mm high; 6 self-adhesive strips per card; plain

	white	243-110	100
---	-------	---------	-----

COMPACT Splicing Connectors for All Conductor Types

221 Series

Description and Installation

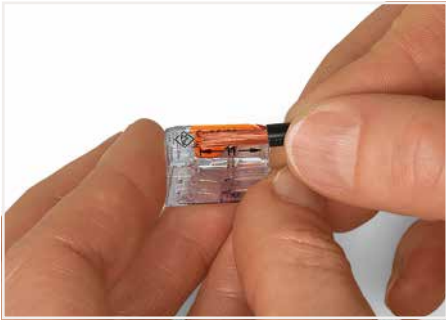

Strip conductor to 11 mm (0.43 inch).



Termination: Lift the lever to open the clamping unit and insert a stripped conductor.

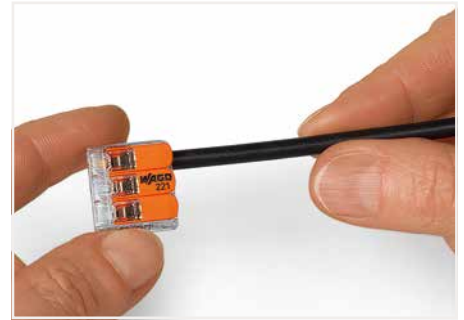

Then, lower the lever to close the clamp.



Wiring fine-stranded conductors in a junction box.



Custom low-voltage lighting system



Wiring fine-stranded conductors in a junction box for in-floor heating.



Lighting distribution in ceiling canopy



Pendant light connection in suspended ceilings

13

CAGE CLAMP® terminates the following copper conductors:
solid "s" stranded "st"

fine-stranded "f-st", also with tinned single strands

fine-stranded, tip-bonded

COMPACT Splicing Connector for All Conductor Types

4 mm²; 221 Series

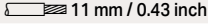
Technical Data	
0.2 ... 4 mm ² "s+str"	24 ... 12 AWG
0.14 ... 4 mm ² "f-st"	600 V, 20 A [Ⓢ]
450 V/4 kV/2 ^①	600 V, 20 A [Ⓢ]
I _N 32 A	
	

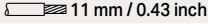
Technical Data	
0.2 ... 4 mm ² "s+str"	24 ... 12 AWG
0.14 ... 4 mm ² "f-st"	600 V, 20 A [Ⓢ]
450 V/4 kV/2 ^①	600 V, 20 A [Ⓢ]
I _N 32 A	
	

^① 450 V = rated voltage
 4 kV = rated impulse voltage
 2 = pollution degree
 (see Section 15)

Approvals and corresponding ratings, visit www.wago.com



Dimensions in mm

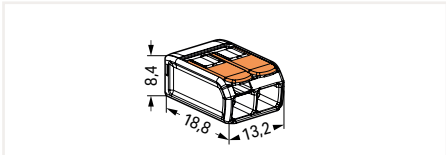

COMPACT splicing connector; for all conductor types; 2-conductor; with levers; transparent housing; continuous operating temperature (max.): 105 °C; surrounding air temperature: max 85 °C (T85)

Item No.	Pack. Unit
221-412	1000 (100)

Dimensions in mm

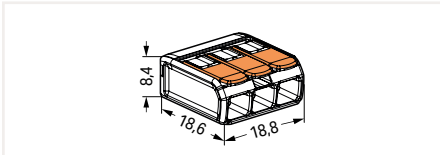

COMPACT splicing connector; for all conductor types; 3-conductor; with levers; transparent housing; continuous operating temperature (max.): 105 °C; surrounding air temperature: max 85 °C (T85)

Item No.	Pack. Unit
221-413	500 (50)



Compact, lever-operated splicing connectors:
 Tool-free connection of up to five stripped, fine-stranded conductors from 0.14 ... 4 mm², as well as solid or stranded conductors from 0.2 ... 4 mm² (24 ... 12 AWG).

How these work:
 Pull up an orange lever to open the clamping unit. Then insert the conductor and push the lever back down, flush with the connector housing.

Safety:
 The specially designed rest position of the lever reliably prevents accidental unclamping of a connected conductor.
 Application safety, for any type of conductor (solid, stranded, fine-stranded), is confirmed by approvals like ENEC or UL.

ENEC is the European mark for electrical products that demonstrates compliance with European safety standards. The ENEC mark is subjected to the same EN standards as the VDE mark.

While the VDE mark is only permitted in Germany, the ENEC mark is accepted in more than 20 European countries.



Dimensions in mm

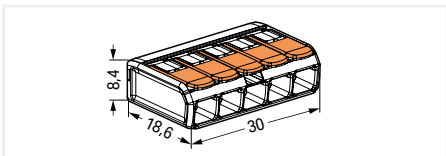

COMPACT splicing connector; for all conductor types; 5-conductor; with levers; transparent housing; continuous operating temperature (max.): 105 °C; surrounding air temperature: max 85 °C (T85)

Item No.	Pack. Unit
221-415	250 (25)

Mounting Carrier 221 Series Installation



Inserting a connector into the mounting carrier.

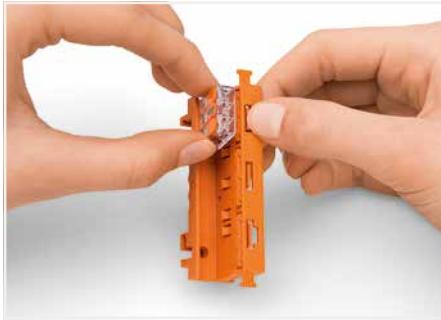

Removing a connector from the mounting carrier.



Removing a conductor.



Testing connectors via test slots on top of the carrier.

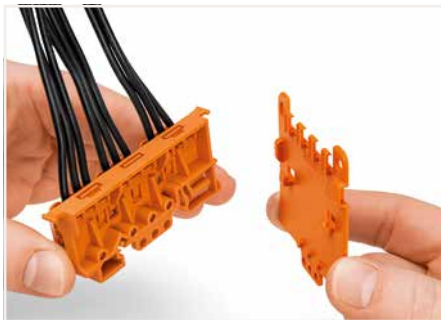

Securing a strain relief plate (222-505) to the mounting carrier.

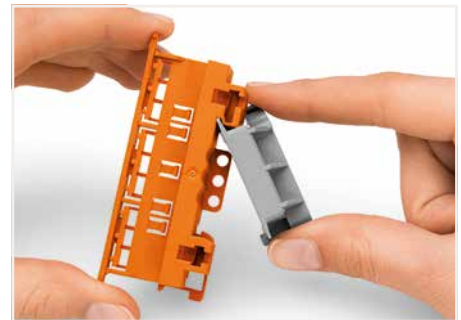

Snapping the angled DIN-rail adapter (222-510) onto the mounting carrier.



Strain relief via cable ties on the mounting carrier (transverse to the connectors' wiring direction) – clamping units labeled via marking strips (210-334)



Vertical mounting with strain relief plate on DIN-35 rail



Horizontal mounting on DIN-35 rail using an angled DIN-rail adapter



Horizontal screw mounting with strain relief plate on a flat surface



Vertical screw mounting with strain relief plate on a flat surface

13

Mounting Carrier 221 Series

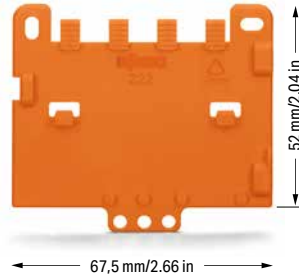
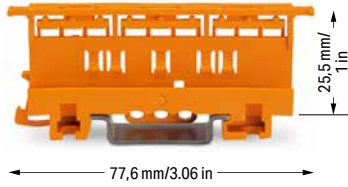

❶ Carriers with a blue insulated housing are suitable for Ex i applications. Both clearances and creepage distances for the protection type "intrinsic safety Ex i" must be observed.

Mounting carrier; for 2-, 3- and 5-wire splicing connectors (4 mm²); 17.5 mm wide

Color	Item No.	Pack. Unit
orange	221-500	50 (10)
blue	221-500/000-006 ❶	50 (10)
dark gray/yellow	221-500/000-053	50 (10)

Strain relief plate; for mounting carrier (221 or 222 Series); snaps on to mounting carrier; 4 mm thick

Color	Item No.	Pack. Unit
orange	222-505	50 (10)

Accessories; item-specific

Marking strip; 5 mm high; 48 self-adhesive strips per card; plain

Color	Item No.	Pack. Unit
white	210-334	100

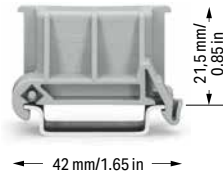

Angled DIN-rail adapter; in combination with mounting carrier (221-500 or 222-500) for DIN-35 rail mounting; 18.5 mm wide

Color	Item No.	Pack. Unit
gray	222-510	50 (10)

Mounting Carrier; for Single Connectors

221 Series

Installation



Inserting a connector into the mounting carrier.



Removing a connector from the mounting carrier.



Inserting a conductor.



Use a cable tie to secure the conductors to the strain relief plate.



Labeling the mounting carrier.



Testing a connector mounted on the carrier via test slot.



The strain relief plate can be removed.



Horizontal screw mounting



Vertical screw mounting



Horizontal mounting via snap-in foot



Vertical mounting via snap-in foot



Connecting a light to the mains.

13

Mounting Carrier; for Single Connectors 221 Series



Dimensions in mm

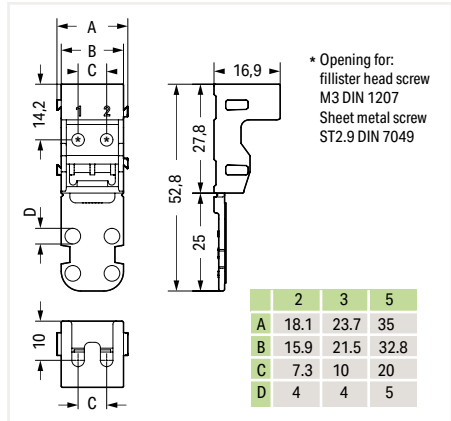

Mounting carrier; for 2-wire connectors (4 mm²); for screw mounting
Dimensions from the surface (mm) W x H x D
18.1 x 16.9 x 52.8

Color	Item No.	Pack. Unit
○ white	221-502	50 (10)
● black	221-502/000-004	50 (10)

Mounting carrier; for 2-wire connectors (4 mm²); with snap-in mounting foot for horizontal mounting
Dimensions from the surface (mm) W x H x D
18.1 x 16.9 (+ 4.5 snap-in mounting foot) x 52.8

○ white	221-512	50 (10)
● black	221-512/000-004	50 (10)

Mounting carrier; for 2-wire connectors (4 mm²); with snap-in mounting foot for vertical mounting
Dimensions from the surface (mm) W x H x D
18.1 x 52.8 (+ 4.5 snap-in mounting foot) x 16.9

○ white	221-522	50 (10)
● black	221-522/000-004	50 (10)

More information on dimensions is available upon request.

Accessories; item-specific

Marking strip; 5 mm high; 48 self-adhesive strips per card; plain

white	210-334	100
-------	---------	-----

Dimensions in mm

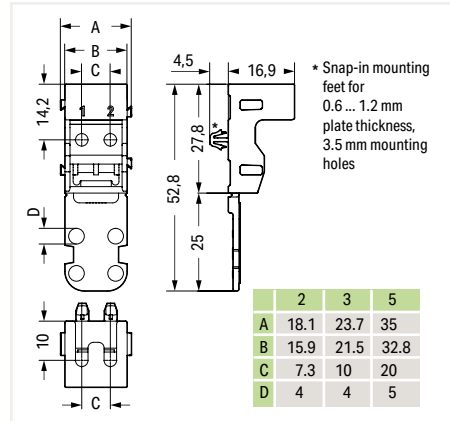

Mounting carrier; for 3-wire connectors (4 mm²); for screw mounting
Dimensions from the surface (mm) W x H x D
18.1 x 16.9 x 52.8

Color	Item No.	Pack. Unit
○ white	221-503	50 (10)
● black	221-503/000-004	50 (10)

Mounting carrier; for 3-wire connectors (4 mm²); with snap-in mounting foot for horizontal mounting
Dimensions from the surface (mm) W x H x D
18.1 x 16.9 (+ 4.5 snap-in mounting foot) x 52.8

○ white	221-513	50 (10)
● black	221-513/000-004	50 (10)

Mounting carrier; for 3-wire connectors (4 mm²); with snap-in mounting foot for vertical mounting
Dimensions from the surface (mm) W x H x D
18.1 x 52.8 (+ 4.5 snap-in mounting foot) x 16.9

○ white	221-523	50 (10)
● black	221-523/000-004	50 (10)

Dimensions in mm

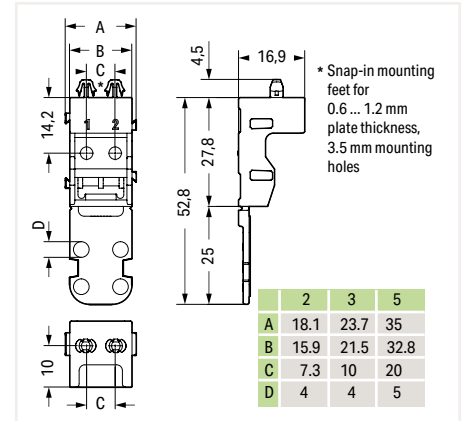

Mounting carrier; for 5-wire connectors (4 mm²); for screw mounting
Dimensions from the surface (mm) W x H x D
18.1 x 16.9 x 52.8

Color	Item No.	Pack. Unit
○ white	221-505	50 (10)
● black	221-505/000-004	50 (10)

Mounting carrier; for 5-wire connectors (4 mm²); with snap-in mounting foot for horizontal mounting
Dimensions from the surface (mm) W x H x D
18.1 x 16.9 (+ 4.5 snap-in mounting foot) x 52.8

○ white	221-515	50 (10)
● black	221-515/000-004	50 (10)

Mounting carrier; for 5-wire connectors (4 mm²); with snap-in mounting foot for vertical mounting
Dimensions from the surface (mm) W x H x D
18.1 x 52.8 (+ 4.5 snap-in mounting foot) x 16.9

○ white	221-525	50 (10)
● black	221-525/000-004	50 (10)

COMPACT Splicing Connectors for All Conductor Types

221 Series

Description and Installation

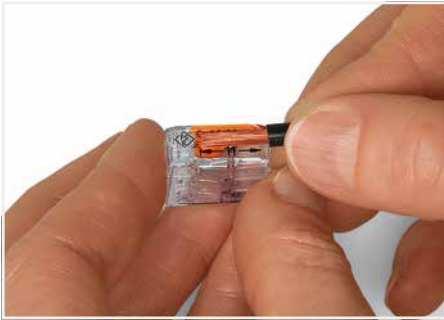

Strip conductor to 12 ... 14 mm (0.47 ... 0.55 inch).



Termination: Lift the lever to open the clamping unit and insert a stripped conductor.

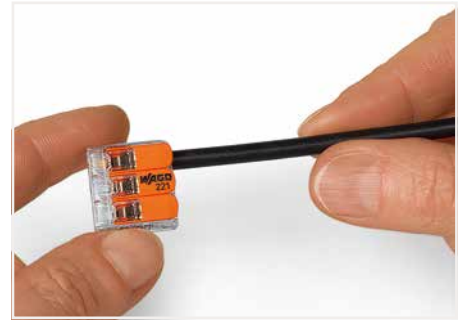

Then, lower the lever to close the clamp.

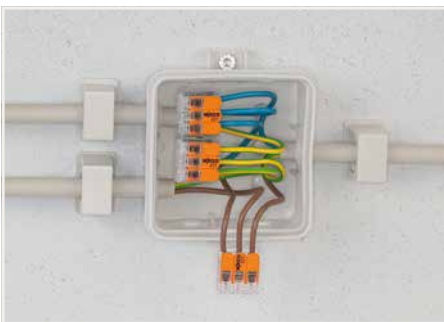

Wiring fine-stranded conductors in a junction box.



Custom low-voltage lighting system



Wiring fine-stranded conductors in a junction box for in-floor heating.



Lighting distribution in ceiling canopy



Pendant light connection in suspended ceilings

13

CAGE CLAMP® terminates the following copper conductors:
solid "s" stranded "st"

fine-stranded "f-st", also with tinned single strands

fine-stranded, tip-bonded

COMPACT Splicing Connector for All Conductor Types and Mounting Carrier

6 mm²; 221 Series

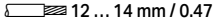
Technical Data	
0.5 ... 6 mm ²	20 ... 10 AWG
450 V/4 kV/2 ①	600 V, 30 A [Ⓢ]
I _N 41 A	600 V, 20 A [Ⓢ]
 12 ... 14 mm / 0.47 ... 0.55 inch	

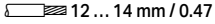
Technical Data	
0.5 ... 6 mm ²	20 ... 10 AWG
450 V/4 kV/2 ①	600 V, 30 A [Ⓢ]
I _N 41 A	600 V, 20 A [Ⓢ]
 12 ... 14 mm / 0.47 ... 0.55 inch	

- ① 450 V = rated voltage
4 kV = rated impulse voltage
2 = pollution degree
(see Section 15)
 - ② Carriers with a blue insulated housing are suitable for Ex i applications. Both clearances and creepage distances for the protection type "intrinsic safety Ex i" must be observed.
- Approvals and corresponding ratings, visit www.wago.com



Dimensions in mm

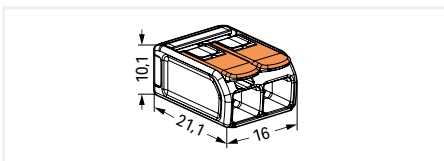

COMPACT splicing connector; for all conductor types; 2-conductor; with levers; transparent housing; continuous operating temperature (max.): 105 °C; surrounding air temperature: max 85 °C (T85)

Item No.	Pack. Unit
221-612	500 (50)

Dimensions in mm

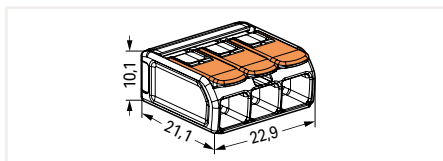

COMPACT splicing connector; for all conductor types; 3-conductor; with levers; transparent housing; continuous operating temperature (max.): 105 °C; surrounding air temperature: max 85 °C (T85)

Item No.	Pack. Unit
221-613	300 (30)



Compact, lever-operated splicing connectors:
Connect up to five stripped conductors from 0.5 to 6 mm² (20 ... 10 AWG) – without tools!

How these work:
Pull up one of the orange operating levers to open the clamping unit. Then insert the conductor and push the lever back down, flush with the connector housing.

Safety:
The lever's specially designed rest position reliably prevents accidental unclamping of a connected conductor. Application safety, for any type of conductor (solid, stranded, fine-stranded), is confirmed by approvals like ENEC or UL.

ENEC is the European mark for electrical products that demonstrates compliance with European safety standards. The ENEC mark is subjected to the same EN standards as the VDE mark.

While the VDE mark is only permitted in Germany, the ENEC mark is accepted in more than 20 European countries.



Dimensions in mm

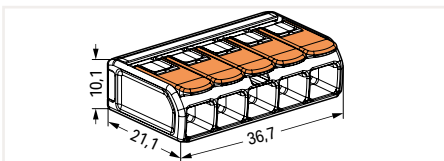

COMPACT splicing connector; for all conductor types; 5-conductor; with levers; transparent housing; continuous operating temperature (max.): 105 °C; surrounding air temperature: max 85 °C (T85)

Item No.	Pack. Unit
221-615	150 (15)

Mounting carrier; for 2-, 3- and 5-wire splicing connectors (6 mm²); 19.3 mm wide

Color	Item No.	Pack. Unit
orange	221-510	50 (10)
blue	221-510/000-006 ②	50 (10)
dark gray/yellow	221-510/000-053	50 (10)

Accessories; item-specific
Marking strip; 5 mm high; 48 self-adhesive strips per card; plain

white	210-334	100
-------	---------	-----



COMPACT Splicing Connectors for All Conductor Types and Mounting Carrier for Ex Splicing Connectors; for Ex eb Applications; 221 Series Description and Installation

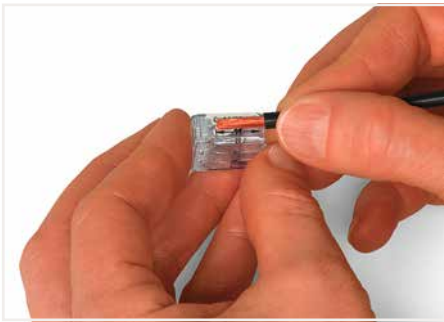

Strip conductor to 11 mm (0.43 inch).

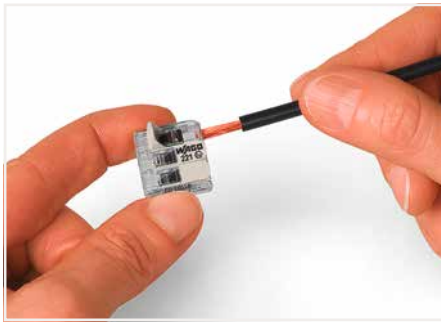

Termination: Lift the lever to open the clamping unit and insert a stripped conductor.

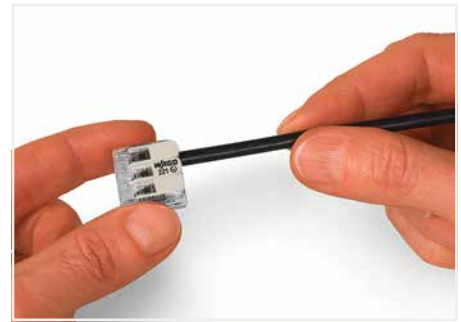

Then, lower the lever to close the clamp.

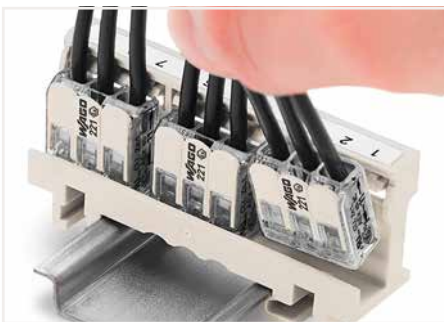

Inserting a connector into the mounting carrier.



Removing a connector from the mounting carrier.

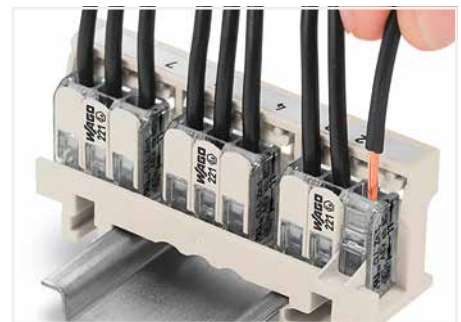

Removing a conductor.

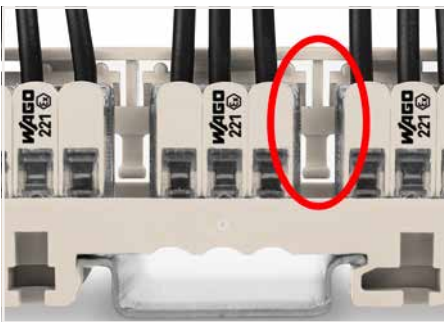

Mounting type (440 V)
A spacer integrated in the adapter can be seen between two connectors.



Mounting type (440 V)
Vertical mounting on DIN-35 rail



Mounting type (275 V)
A spacer integrated in the adapter **cannot** be seen between two connectors; the connector housings are close together.

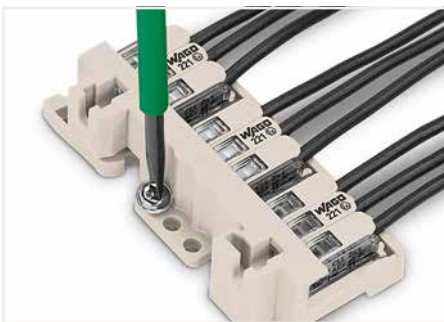

Mounting type (440 V)
Horizontal screw mounting on a flat surface



Mounting type (440 V)
Mounting the carrier via non-conductive screws.



Mounting type (275 V)
Mounting the carrier using conductive screws.

CAGE CLAMP® terminates the following copper conductors:
solid "s" stranded "st"

fine-stranded "f-st",
also with tinned
single strands

fine-stranded,
tip-bonded

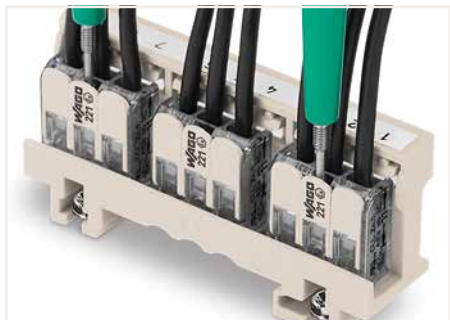

Easily test inserted connectors in the carrier – however they are mounted.



Wiring example in an Ex e junction box
Labeling is performed via marking strips (210-334) and pen or continuous labels (210-834), which is printed via Smart Printer (258-5000).



Carriers with a blue insulated housing are suitable for Ex i applications. Both clearances and creepage distances for the protection type "intrinsic safety Ex i" must be observed.

COMPACT Splicing Connector for All Conductor Types and Mounting Carrier; for Ex eb Applications

4 mm²; 221 Series

Technical Data	
IEC / EN 60079-7	UL 60079-7
Ⓔ IECEX Ex eb IIC Gb	Ⓔ Cl. I, Zn. 1, AEx eb IIC CNR Ex eb IIC U
0.2 ... 4 mm² "s+str"	24 ... 12 AWG "s+st"
0.14 ... 4 mm² "f-st"	24 ... 12 AWG "f-st"
440 V (275 V) ①	440 V (275 V), 20 A, ①
I _N 24.5 A	
Operating temperature: -55 ... +105 °C	
11 mm / 0.43 inch	

Technical Data	
IEC / EN 60079-7	UL 60079-7
Ⓔ IECEX Ex eb IIC Gb	Ⓔ Cl. I, Zn. 1, AEx eb IIC CNR Ex eb IIC U
0.2 ... 4 mm² "s+str"	24 ... 12 AWG "s+st"
0.14 ... 4 mm² "f-st"	24 ... 12 AWG "f-st"
440 V (275 V) ①	440 V (275 V), 20 A, ①
I _N 32 A	
Operating temperature: -55 ... +105 °C	
11 mm / 0.43 inch	



Dimensions in mm

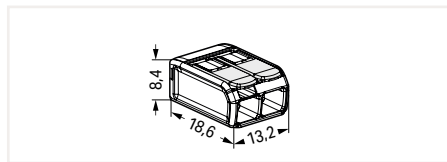

COMPACT splicing connector; for all conductor types; for Ex eb applications; 2-conductor; with levers; transparent housing; operating temperature (max.): 105 °C

Item No.	Pack. Unit
221-482 ②	1000 (100)

Dimensions in mm

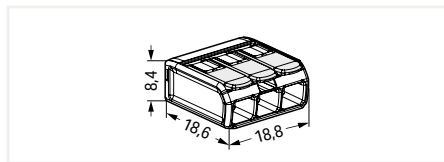

COMPACT splicing connector; for all conductor types; for Ex eb applications; 3-conductor; with levers; transparent housing; operating temperature (max.): 105 °C

Item No.	Pack. Unit
221-483 ②	500 (50)

① The permissible operating voltage of the connector with carrier (440 V or 275 V) depends on the mounting type. The mounting types for both 440 V and 275 V are shown on the "Description and Installation" page. If a mounting type for 275 V is used, this is the permissible working voltage.

② Only approved in conjunction with a mounting carrier (221-501). Other carriers are possible, see certificate (UL).

The connectors must be installed in an enclosure meeting the requirements of a recognized protection type per EN 60079-0, Section 1 or EN 60079-31. When installing the connectors in an enclosure of protection type "eb" (increased safety) per EN 60079-7, the clearances and creepage distances of Table 2 for this standard must be observed (for the use of accessories see point 1).

The connectors can be used both in Group II and Group I, as the standard requirements are identical in this case.

The use of these components requires a new assessment by a notified certification agency.

③ Carriers with a blue insulated housing are suitable for Ex i applications. Both clearances and creepage distances for the protection type "intrinsic safety Ex i" must be observed.

Approvals and corresponding ratings, visit www.wago.com

Your benefits at a glance:

- New design possibilities for the manufacturers of junction boxes, luminaires and electronic devices for Ex eb areas
- Approval also possible with custom mounting solutions
- Easy to use: Pull the lever up, insert a conductor and push the lever back down – done.
- Easy-to-use design adds value for installers
- Time- and cost-saving spring pressure connection technology
- Vibration-proof and maintenance-free connection
- 100% touch-proof protection
- Connectors can be secured in position via mounting carriers according to standards

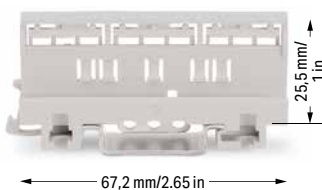

Dimensions in mm

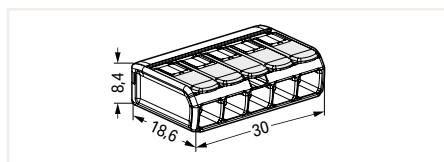

COMPACT splicing connector; for all conductor types; for Ex eb applications; 5-conductor; with levers; transparent housing; operating temperature (max.): 105 °C

Item No.	Pack. Unit
221-485 ②	250 (25)

Mounting carrier; for 2-, 3- and 5-wire Ex splicing connectors (4 mm²); 17.5 mm wide

Color	Item No.	Pack. Unit
○ light gray	221-501	50 (10)
● blue	221-500/000-006 ③	50 (10)

Item-Specific Accessories

Self-adhesive marking strip; 5 mm high; 48 self-adhesive strips per card; plain

Color	Item No.	Pack. Unit
white	210-334	100

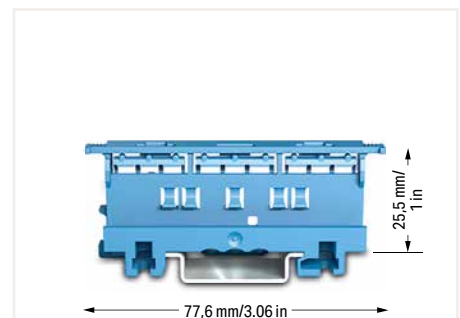

Carriers with a blue insulated housing are suitable for Ex i applications. Both clearances and creepage distances for the protection type "intrinsic safety Ex i" must be observed.

COMPACT Splicing Connector for All Conductor Types and Mounting Carrier; for Ex eb Applications

6 mm²; 221 Series

Technical Data	
IEC / EN 60079-7	UL 60079-7
Ⓔ IECEX Ex eb IIC Gb	Ⓔ Cl. I, Zn. 1, AEx eb IIC CNR Ex eb IIC U
0.5 ... 6 mm ²	20 ... 10 AWG
440 V (275 V) ①	440 V (275 V), 20 A ①
I _N 37 A	
Operating temperature: -55 ... +105 °C	
12 ... 14 mm / 0.47 ... 0.55 inch	

Technical Data	
IEC / EN 60079-7	UL 60079-7
Ⓔ IECEX Ex eb IIC Gb	Ⓔ Cl. I, Zn. 1, AEx eb IIC CNR Ex eb IIC U
0.5 ... 6 mm ²	20 ... 10 AWG
440 V (275 V) ①	440 V (275 V), 20 A ①
I _N 37 A	
Operating temperature: -55 ... +105 °C	
12 ... 14 mm / 0.47 ... 0.55 inch	

- The permissible operating voltage of the connector with carrier (440 V or 275 V) depends on the mounting type.
The mounting types for both 440 V and 275 V are shown on the "Description and Installation" page. If a mounting type for 275 V is used, this is the permissible working voltage.
 - Only approved in conjunction with a mounting carrier (221-511). Other carriers are possible, see certificate (UL).
The connectors must be installed in an enclosure meeting the requirements of a recognized protection type per EN 60079-0, Section 1 or EN 60079-31. When installing the connectors in an enclosure of protection type "eb" (increased safety) per EN 60079-7, the clearances and creepage distances of Table 2 for this standard must be observed (for the use of accessories see point 1).
The connectors can be used both in Group II and Group I, as the standard requirements are identical in this case.
The use of these components requires a new assessment by a notified certification agency.
 - Carriers with a blue insulated housing are suitable for Ex i applications. Both clearances and creepage distances for the protection type "intrinsic safety Ex i" must be observed.
- Approvals and corresponding ratings, visit www.wago.com



Dimensions in mm

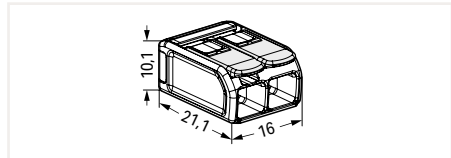

COMPACT splicing connector; for all conductor types; for Ex eb applications; 2-conductor; with levers; transparent housing; operating temperature (max.): 105 °C

Item No.	Pack. Unit
221-682 ②	500 (50)



Dimensions in mm

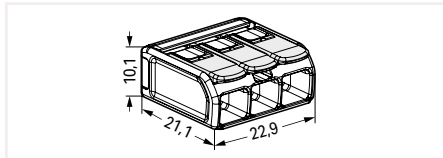

COMPACT splicing connector; for all conductor types; for Ex eb applications; 3-conductor; with levers; transparent housing; operating temperature (max.): 105 °C

Item No.	Pack. Unit
221-683 ②	300 (30)

- Your benefits at a glance:**
- New design possibilities for the manufacturers of junction boxes, luminaires and electronic devices for Ex eb areas
 - Approval also possible with custom mounting solutions
 - Easy to use: Pull the lever up, insert a conductor and push the lever back down – done.
 - Easy-to-use design adds value for installers
 - Time- and cost-saving spring pressure connection technology
 - Vibration-proof and maintenance-free connection
 - 100% touch-proof protection
 - Connectors can be secured in position via mounting carriers according to standards

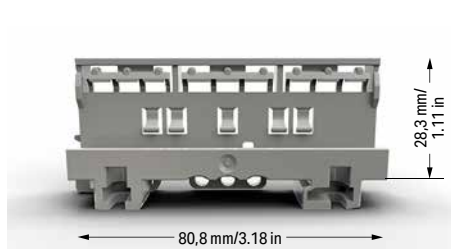

Dimensions in mm

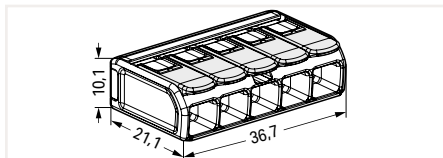

Mounting carrier; for 2-, 3- and 5-wire Ex splicing connectors (6 mm²); 19.3 mm wide

Color	Item No.	Pack. Unit
○ light gray	221-511	50 (10)
● blue	221-510/000-006 ③	50 (10)

Item-Specific Accessories

Self-adhesive marking strip; 5 mm high; 48 self-adhesive strips per card; plain

Color	Item No.	Pack. Unit
white	210-334	100

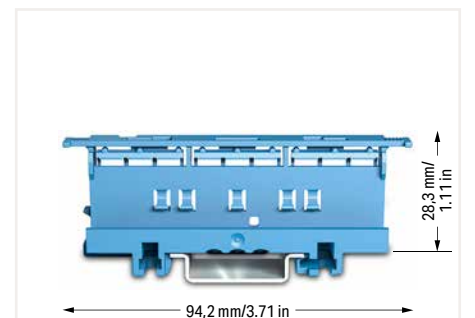

Carriers with a blue insulated housing are suitable for Ex i applications. Both clearances and creepage distances for the protection type "intrinsic safety Ex i" must be observed.

Jumpers With and Without Locking Function Installation

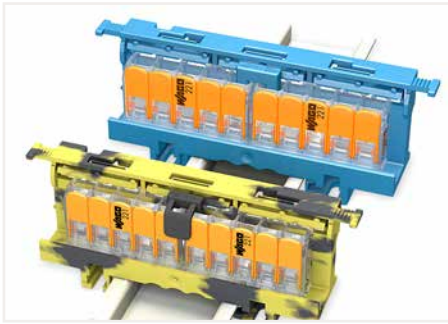

Extending the N and PE (ground) distribution via jumper

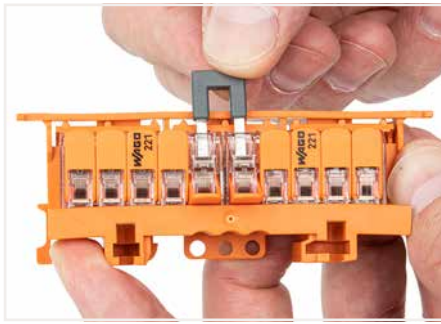

Insert the jumper without a locking function into open clamping units.

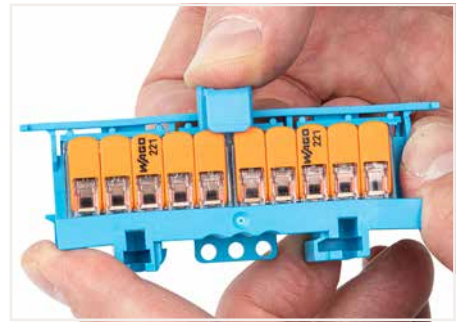

Insert the jumper with a locking function into closed clamping units.

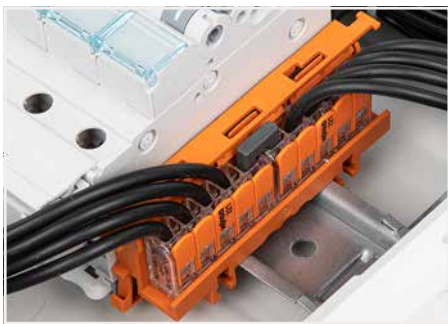

Without locking function:
The jumper without a locking function is plugged into the splicing connectors.

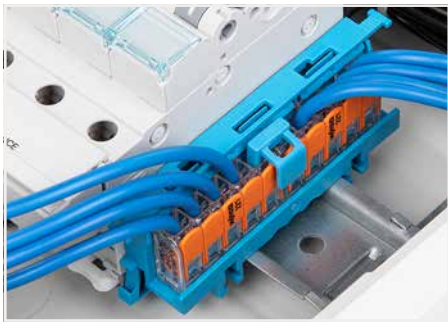

With locking function:
The jumper with a locking function is plugged into the splicing connectors.

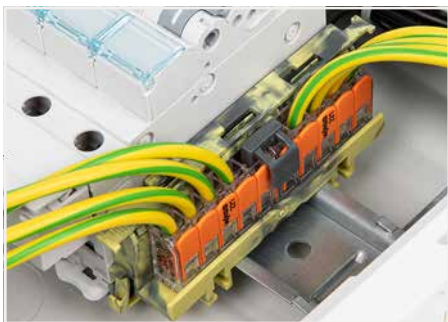

The lockable jumper is plugged into the splicing connectors.

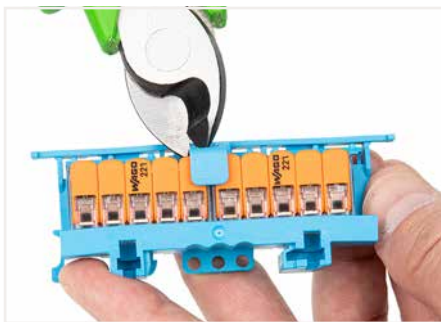

Remove the locking mechanism for intentional jumper removal.



Remove the jumper from open clamping units.

Jumper With and Without Locking Function 221 Series

Technical Data
400 V
I _N 41 A



Technical Data
400 V
I _N 41 A



Jumper; with locking function		
	Item No.	Pack. Unit
● dark gray	221-941	50
● blue	221-941/000-006	50

Jumper; without locking function		
	Item No.	Pack. Unit
● dark gray	221-942	50
● blue	221-942/000-006	50

Yellowoxes; for Splicing Connectors

207 Series

Installation



Open the Yellowox at the side latches.

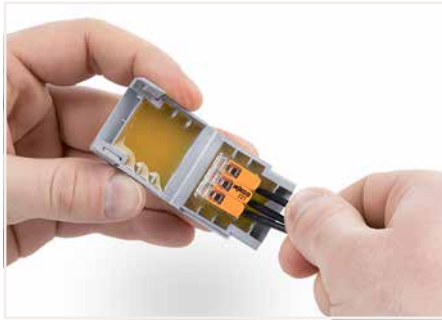

Place the wired connector in the Yellowox.

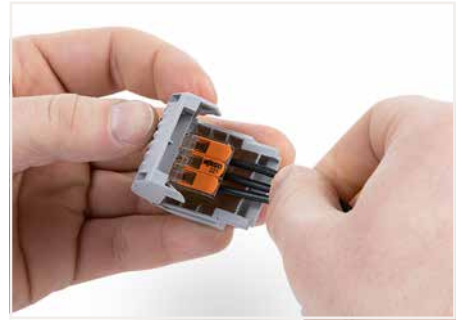

Close the Yellowox.



Close latch securely and press down in the center.



Re-accessible:
Open the Yellowox, remove the gel, open the connector and rewire with new components.



For low voltage applications > 50 V, use the Yellowox in a junction box.



Connecting a bollard light



Opened Yellowox with connector

13

Yellowox; for Splicing Connectors

207 Series

Technical Data
Housing material: Polypropylene
Gel material: Polyurethane
Voltage range: see connector voltage
Rated current: see connector current
Rated surge voltage: 2.5 kV
Insulation resistance: 5 MΩ
Surrounding air temperature (operation): -55 ... 85 °C
Surrounding air temperature (storage): 0 ... 40 °C
Physical properties: IPX8
Suitable for indefinite storage because the gel is free of hazardous substance according to CLP
Disposal: Household waste (residual waste)
Skin contact: After skin contact, clean with water; no special cleaning agent required

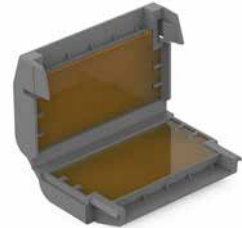
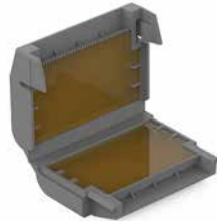

Yellowox; for conductors; branch; with gel; 221, 2273 Series; without splicing connectors; size 1		
Color	Item No.	Pack. Unit
○ gray	207-1331	48 (4)

Yellowox; for conductors; branch; with gel; 221, 2273 Series; without splicing connectors; size 2		
Color	Item No.	Pack. Unit
○ gray	207-1332	48 (4)

Yellowox; for conductors; branch; with gel; 221, 2273 Series; without splicing connectors; size 3		
Color	Item No.	Pack. Unit
○ gray	207-1333	36 (3)

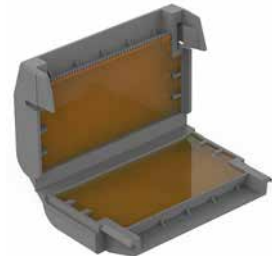
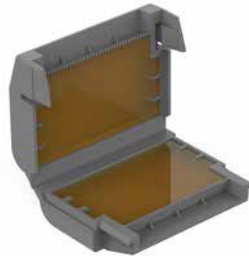
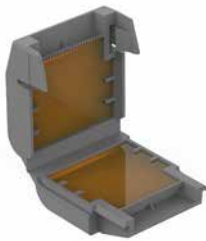

Yellowox; for conductors; branch; with gel; 221 Series, max. 6 mm² connectors; without splicing connectors; size 1		
Color	Item No.	Pack. Unit
○ gray	207-1431	48 (4)

Yellowox; for conductors; branch; with gel; 221 Series, max. 6 mm² connectors; without splicing connectors; size 2		
Color	Item No.	Pack. Unit
○ gray	207-1432	36 (3)

Yellowox; for conductors; branch; with gel; 221 Series, max. 6 mm² connectors; without splicing connectors; size 3		
Color	Item No.	Pack. Unit
○ gray	207-1433	24 (2)

Permitted Combinations of Connectors and Yellowox:

Item No.	221-412	221-413	221-415	221-612	221-613	221-615	2273-202	2273-203	2273-204	2273-208
207-1331	1 x	1 x	-				2 x	-	1 x	1 x
207-1332	2 x	-	1 x				3 x	2 x	-	1 x
207-1333	3 x	2 x	-				4 x	-	2 x	2 x
207-1431				1 x	1 x	-				
207-1432				2 x	-	1 x				
207-1433				3 x	2 x	-				

Note: With other combinations, the high degree of protection cannot be guaranteed because the gel displacement is too limited or the Gel Boxes can no longer be closed.

Yellowoxes; for Splicing Connectors

207 Series

Packaging Instructions

Note on Packaging Unit (PU) and Subpackaging Unit (SPU):

If you order a full PU, you will receive our eco-friendly, sustainable cardboard blisters packed in a shelf-ready box.

If you order a quantity smaller than a full PU, you will receive the eco-friendly, sustainable cardboard blisters without a shelf-ready box.



Lift the flap and pull the cover perforation forward.



Press in the perforation on the sides.



Tear off the cover from the perforation.



As a counter display: Bend the rear flap at the fold, straighten it and fix it in the cardboard cut-out



If the flap is not required, tear off from the perforation.



Self-service shelving system with Euro-slot hang tabs for product display

Junction Boxes; for 221 Series Splicing Connectors (4 mm²) 207 Series Installation



The junction box is designed for surface screw mounting on the wall/ceiling. The cover can be snapped on and off without screws. The connectors are easily mounted by snapping them in, and the marking strips are mounted by simply pushing them in.



Snap the connector into the holder.



Release the connector from the holder.

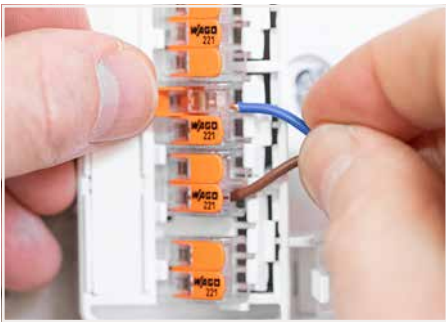

Inserting a conductor



Snap the marking strips into the holder.



Insert the cable into the strain relief. The snap-in strain reliefs are designed for cable diameters from 4 mm to 11 mm.



Break the cable entry lid out of the cover.



Snap on the junction box cover.



Open the junction box cover.

Junction Box; for 221 Series Splicing Connectors (4 mm²) 207 Series

Technical Data

Dimensions (width x height x depth): 225 x 46 x 145 mm

Protection type: IP20

Current supply: 18 A (max.)

Operating voltage: 450 V (max.)

DEKRA test report per EN and BS 60670-22

Designed for up to 60 connection points



Junction box; for 221 Series splicing connectors – 4 mm²
(221-41x, not included in delivery)

Color	Item No.	Pack. Unit
<input type="radio"/> white	207-4301	1

Accessories; 207 Series

Accessory set; consists of 6 double-deck strain reliefs
and marking strips



207-9301 1

Inline Splicing Connectors

221 Series

Installation



Push up the lever to open the clamping unit and insert the conductor.



Push the lever back down.

Your Benefits:

- Inline connection of solid, stranded and fine-stranded conductors from 0.2 to 4 mm²
- Slim design needs minimum space in tight areas
- Tool-free connection and disconnection thanks to convenient lever technology
- Use a mounting carrier for fixed and multi-pole wiring

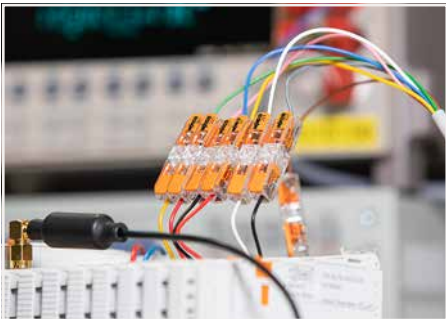
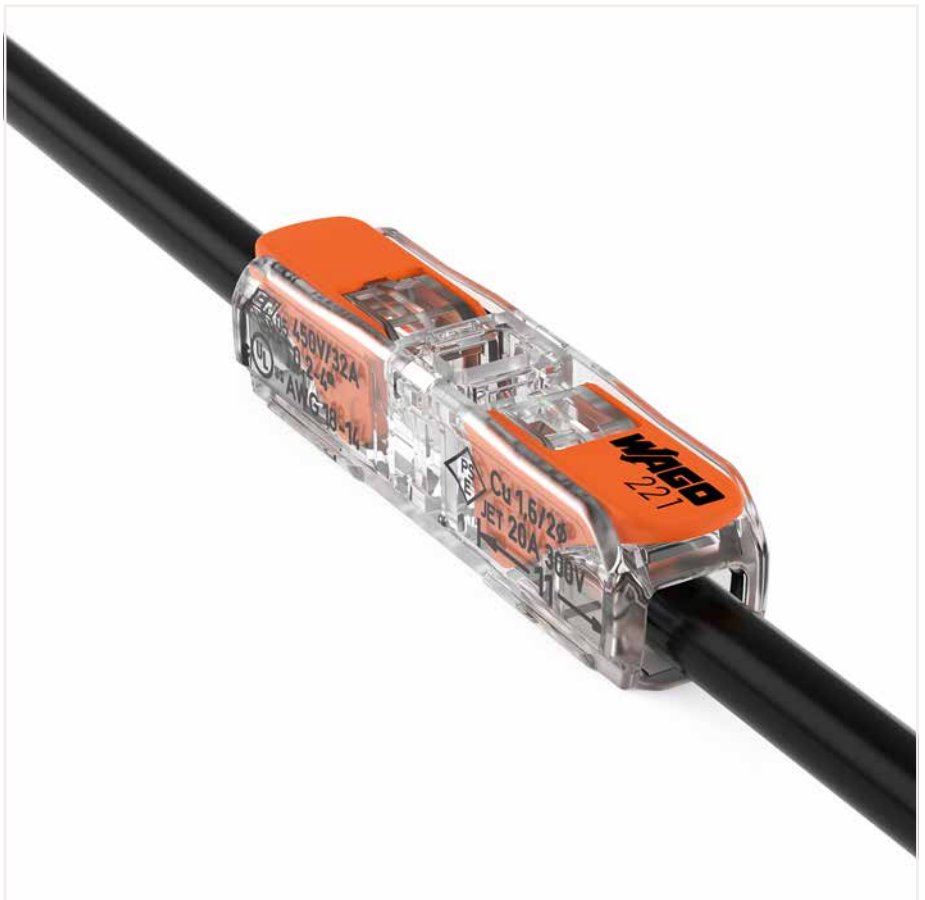

Perfect for test setups



Simple extension of lines



Lighting connection in suspended ceilings



Multi-pole, fixed lighting fixture wiring

CAGE CLAMP® terminates the following copper conductors:
solid "s" stranded "st"

fine-stranded "f-st", also with tinned single strands

fine-stranded, tip-bonded

Inline Splicing Connector 221 Series

Technical Data	
0.2 ... 4 mm ² "s"	20 ... 14 AWG "s"
0.2 ... 2.5 mm ² "st"	18 ... 14 AWG "st"
0.2 ... 4 mm ² "f-st"	18 ... 14 AWG "f-st"
450 V/4 kV/2 ①	600 V, 20 A-②
I _N 32 A	
11 mm / 0.43 inch	



Dimensions in mm

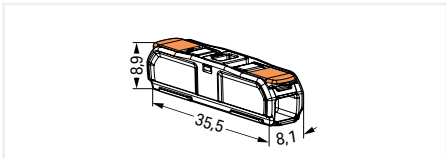

Inline splicing connector with levers; transparent housing; transparent cover		
	Item No.	Pack. Unit
	221-2411	600 (60)

Technical Data	
0.2 ... 4 mm ² "s"	20 ... 12 AWG "s"
0.2 ... 2.5 mm ² "st"	18 ... 12 AWG "st"
0.34 ... 4 mm ² "f-st"	18 ... 12 AWG "f-st"
450 V/4 kV/2 ①	600 V, 20 A-②
I _N 32 A	
11 mm / 0.43 inch	



Dimensions in mm

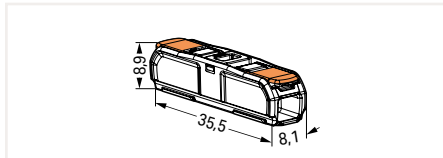

Inline splicing connector with levers; transparent housing; white cover		
	Item No.	Pack. Unit
	221-2401	600 (60)

① 450 V = rated voltage
4 kV = rated impulse voltage
2 = pollution degree (see Section 14)

Approvals and corresponding ratings, visit www.wago.com

Mounting Carrier; for Inline Splicing Connectors Installation



Place the inline splicing connector on the carrier in front of the mounting position.

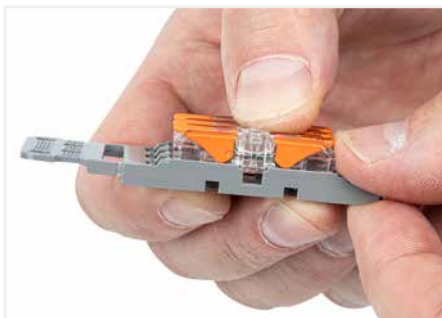

Push the connector to the center position until it snaps into place.



Conductor wiring can also be performed in fixed position.



Various combinations of 1- to 5-connector mounting carriers are possible via side-by-side latching mechanism.

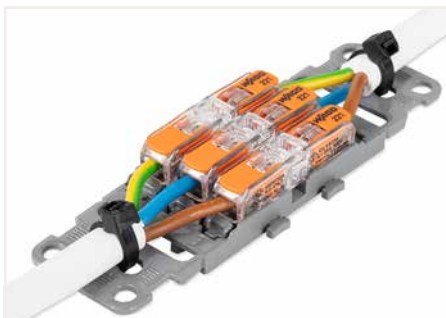

3-pole mounting carrier with strain relief



Mounting carrier without strain relief – snapped onto DIN-rail

Mounting Carrier; for Inline Splicing Connectors 221 Series



Dimensions in mm

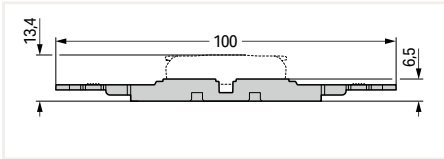

Mounting carrier with strain relief; for inline splicing connector with levers; for screw mounting; gray

	Item No.	Pack. Unit
○ 1x	221-2501	25 (5)
○ 2x	221-2502	25 (5)
○ 3x	221-2503	25 (5)
○ 4x	221-2504	25 (5)
○ 5x	221-2505	25 (5)

Dimensions in mm

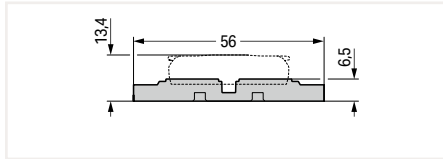

Mounting carrier; for inline splicing connector with levers; for screw mounting; gray

	Item No.	Pack. Unit
○ 1x	221-2521	25 (5)
○ 2x	221-2522	25 (5)
○ 3x	221-2523	25 (5)
○ 4x	221-2524	25 (5)
○ 5x	221-2525	25 (5)

Accessories; 221 Series

Appropriate marking systems:
WMB/WMB Inline/Marking strips

Mounting foot; can be screwed on terminal blocks with mounting flange; for DIN-15 rail; 6.4 mm wide



gray 209-1116 25

Marking strip; as DIN A4 sheet; 5 mm high; 182 mm long; plain; self-adhesive



white 210-334 100



Dimensions in mm

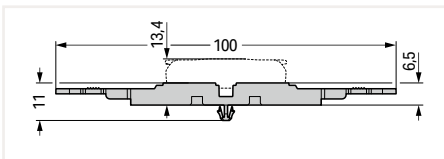

Mounting carrier with strain relief; for inline splicing connector with levers; with snap-in mounting foot; gray

	Item No.	Pack. Unit
○ 1x	221-2511	25 (5)
○ 2x	221-2512	25 (5)
○ 3x	221-2513	25 (5)
○ 4x	221-2514	25 (5)
○ 5x	221-2515	25 (5)

Dimensions in mm

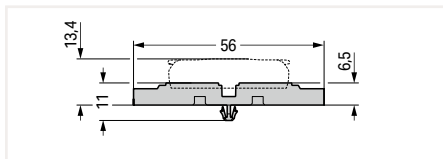

Mounting carrier; for inline splicing connector with levers; with snap-in mounting foot; gray

	Item No.	Pack. Unit
○ 1x	221-2531	25 (5)
○ 2x	221-2532	25 (5)
○ 3x	221-2533	25 (5)
○ 4x	221-2534	25 (5)
○ 5x	221-2535	25 (5)

Accessories; 221 Series

Appropriate marking system: Marking strips

Mounting foot; snaps onto terminal blocks with snap-in mounting foot; for DIN-35 rail; 6.4 mm wide



gray 209-120 25

Mounting foot with screw; can be screwed on terminal blocks with mounting flange; for DIN-35 rail; 6.4 mm wide



gray 209-123 25

Mounting screw; for mounting foot (209-120)

209-119 500 (50)

Mounting foot; snaps onto terminal blocks with snap-in mounting foot; for DIN-15 rail; 6.4 mm wide



gray 209-1115 25

CLASSIC Splicing Connectors for All Conductor Types

222 Series

Description and Installation

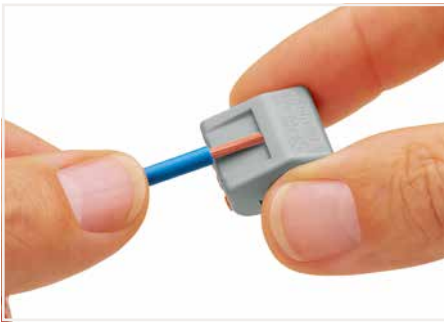

Strip conductor to 9 ... 10 mm (0.35 ... 0.39 inch).

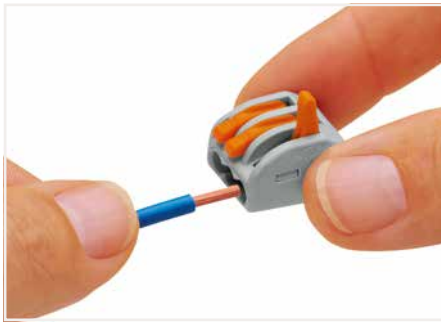

Termination: Lift the lever to open the clamping unit and insert a stripped conductor.

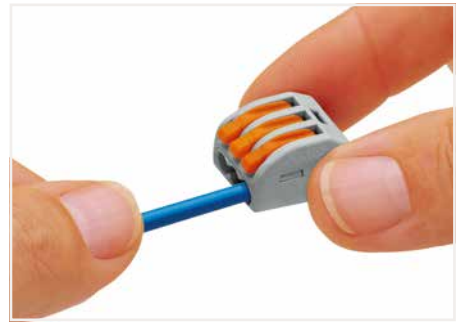

Then, lower the lever to close the clamp.

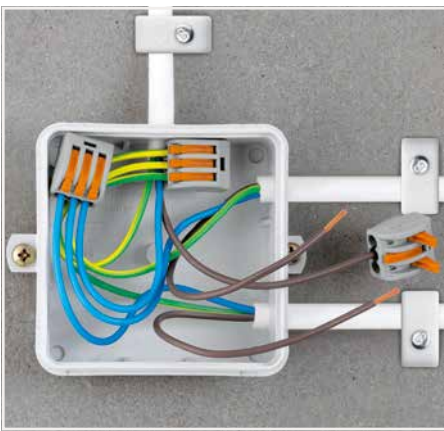

Wiring fine-stranded conductors in a junction box.

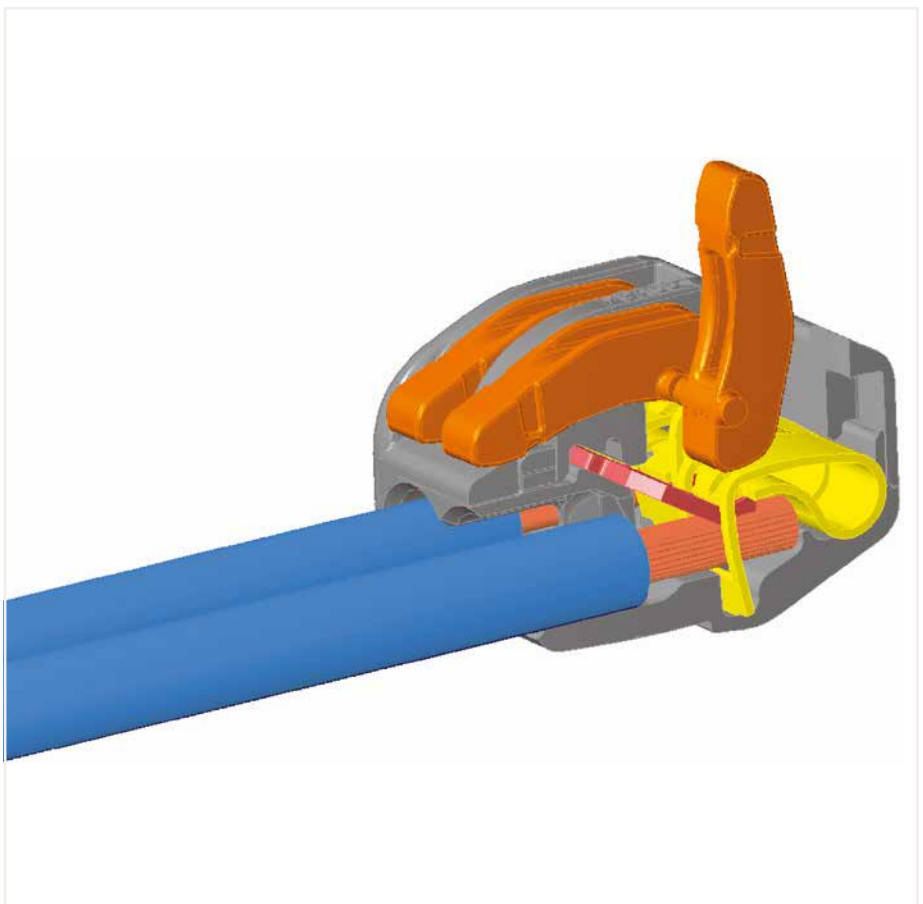

Testing the wired connectors.

CAGE CLAMP® terminates the following copper conductors:
solid "s" stranded "st"

fine-stranded "f-st", also with tinned single strands

fine-stranded, tip-bonded

fine-stranded, with ferrule (gastight crimped)

fine-stranded, with pin terminal (gastight crimped)

With ferruled conductors, it is necessary to use a terminal block one size smaller than the conductor's nominal cross section.

CLASSIC Splicing Connector for All Conductor Types

2.5 mm²; 222 Series

Technical Data	
0.08 ... 2.5 mm ² "s+str"	28 ... 12 AWG "s+st"
0.08 ... 4 mm ² "f-st"	28 ... 12 AWG "f-st"
400 V/4 kV/2 ①	600 V, 20 A ②
I _N 32 A	
9 ... 10 mm / 0.35 ... 0.39 inch	

Technical Data	
0.08 ... 2.5 mm ² "s+str"	28 ... 12 AWG "s+st"
0.08 ... 4 mm ² "f-st"	28 ... 12 AWG "f-st"
400 V/4 kV/2 ①	600 V, 20 A ②
I _N 32 A	
9 ... 10 mm / 0.35 ... 0.39 inch	

- ① In grounded power lines
400 V = rated voltage
4 kV = rated impulse voltage
2 = pollution degree
(see Section 15)

Approvals and corresponding ratings, visit www.wago.com



Dimensions in mm

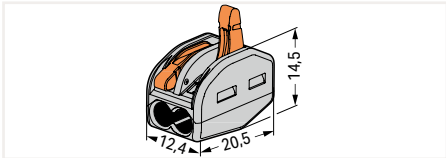

Splicing connector for all conductor types; 2-wire connector; with levers; continuous operating temperature (max.): 85 °C; surrounding air temperature (max.): 40 °C

Color	Item No.	Pack. Unit
○ gray	222-412	500 (50)

Dimensions in mm

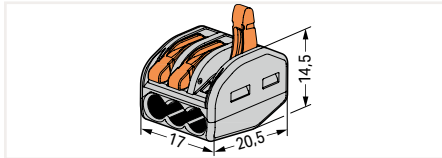

Splicing connector for all conductor types; 3-wire connector; with levers; continuous operating temperature (max.): 85 °C; surrounding air temperature (max.): 40 °C

Color	Item No.	Pack. Unit
○ gray	222-413	500 (50)



Compact, lever-operated splicing connectors:
Tool-free connection of up to five stripped, fine-stranded conductors from 0.08 ... 4 mm² (28 ... 12 AWG), as well as solid or stranded conductors up to 2.5 mm² (12 AWG).

How these work:

Pull up one of the orange operating levers to open the clamping unit so that the lever engages and keeps the clamp in its opened position. Then insert the conductor and push the lever back down, flush with the connector housing.

Safety:

The lever's specially designed rest position reliably prevents accidental unclamping of a connected conductor. Application safety, for any type of conductor (solid, stranded, fine-stranded), is confirmed by approvals like ENEC or UL.

ENEC is the European mark for electrical products that demonstrates compliance with European safety standards. The ENEC mark is subjected to the same EN standards as the VDE mark.

While the VDE mark is only permitted in Germany, the ENEC mark is accepted in more than 20 European countries.



Dimensions in mm

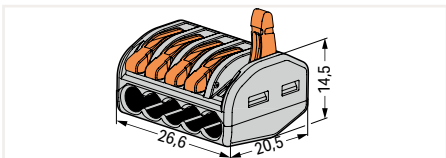

Splicing connector for all conductor types; 5-wire connector; with levers; continuous operating temperature (max.): 85 °C; surrounding air temperature (max.): 40 °C

Color	Item No.	Pack. Unit
○ gray	222-415	400 (40)

Mounting Carrier 222 Series Installation



Horizontal mounting on DIN-35 rail using an angled DIN-rail adapter



Horizontal mounting with strain relief plate on DIN-35 rail using an angled DIN-rail adapter

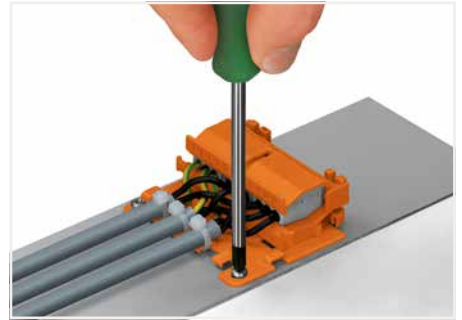

Horizontal screw mounting with strain relief plate on a flat surface



Vertical mounting with strain relief plate on DIN-35 rail; Marking clamping units via marking strips.



Strain relief via cable ties on the mounting carrier (transverse to the connectors' wiring direction); Molded marking clamping units

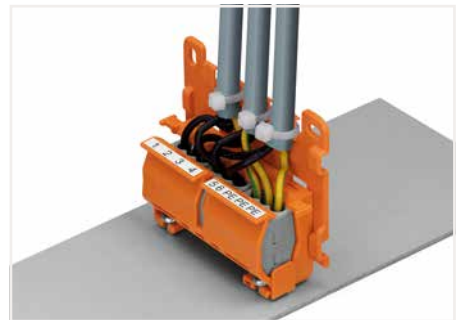

Mounting carrier with strain relief plate mounted vertically on a plate; Round cable secured via strain relief lug.



Snapping the lateral connector safety lock onto the mounting carrier.



Securing a strain relief plate to the mounting carrier.

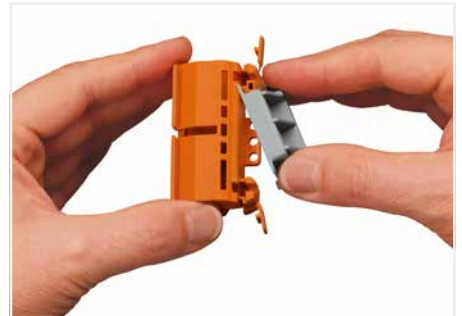

Snapping the angled DIN-rail adapter onto the mounting carrier.

Mounting Carrier 222 Series



Mounting carrier; for 2-, 3- and 5-wire splicing connectors; 22 mm wide

Color	Item No.	Pack. Unit
● orange	222-500	50 (10)

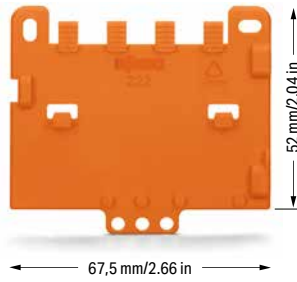

Strain relief plate; for mounting carrier (221 or 222 Series); snaps on to mounting carrier; 4 mm thick

Color	Item No.	Pack. Unit
● orange	222-505	50 (10)

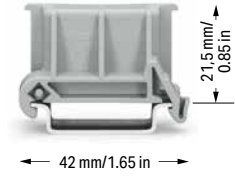

Angled DIN-rail adapter; in combination with mounting carrier (221-500 or 222-500) for DIN-35 rail mounting; 18.5 mm wide

Color	Item No.	Pack. Unit
○ gray	222-510	50 (10)

Accessories; item-specific

Marking strip; 5 mm high; 48 self-adhesive strips per card; plain

	white	210-334	100
---	-------	---------	-----

Lighting Connectors; 224 Series

Lighting Side and Installation Side

Description and Installation

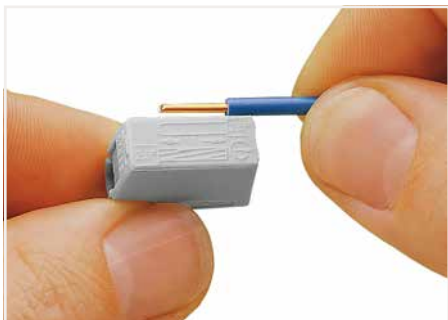

Strip conductor to 9 ... 11 mm (0.35 ... 0.43 inch).

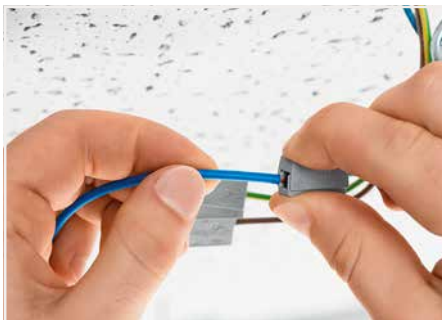

To connect: Press button fully, insert stripped conductor into square entry and release.

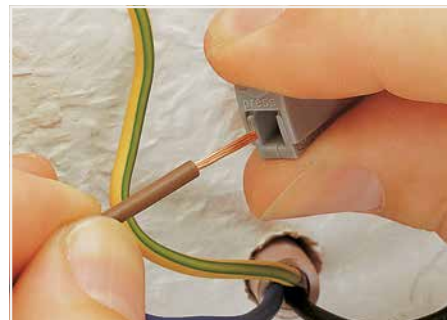

To remove: Press button and withdraw conductor.

Lighting side

CAGE CLAMP® terminates the following copper conductors:

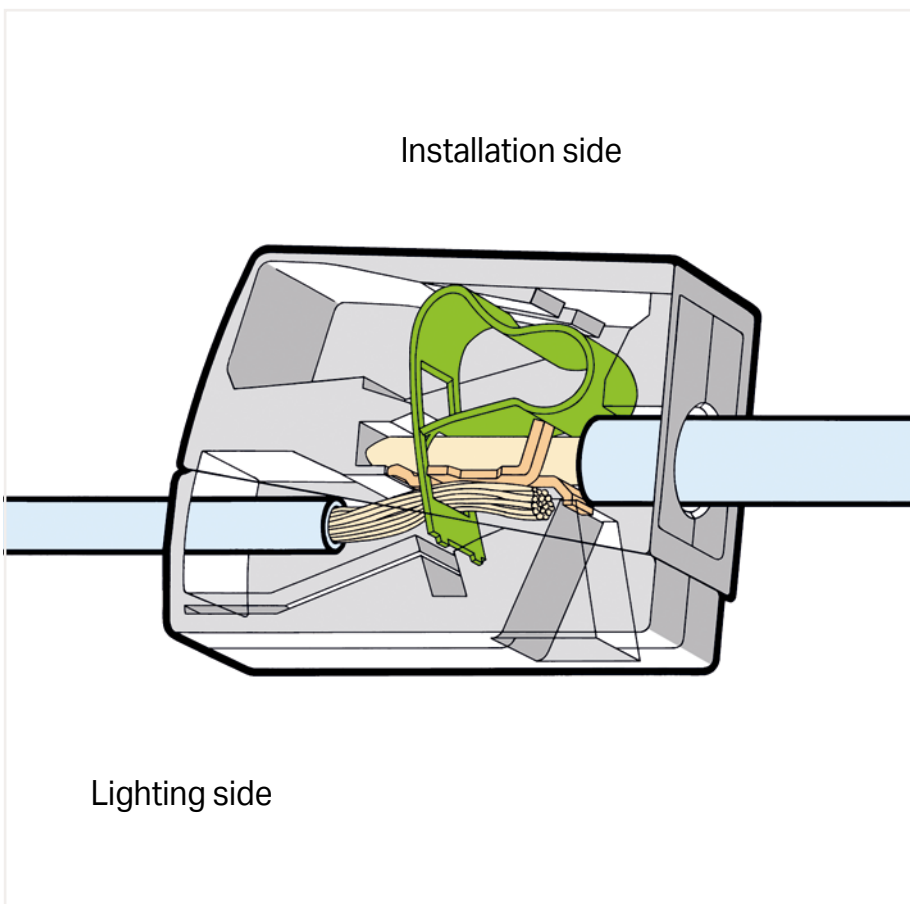
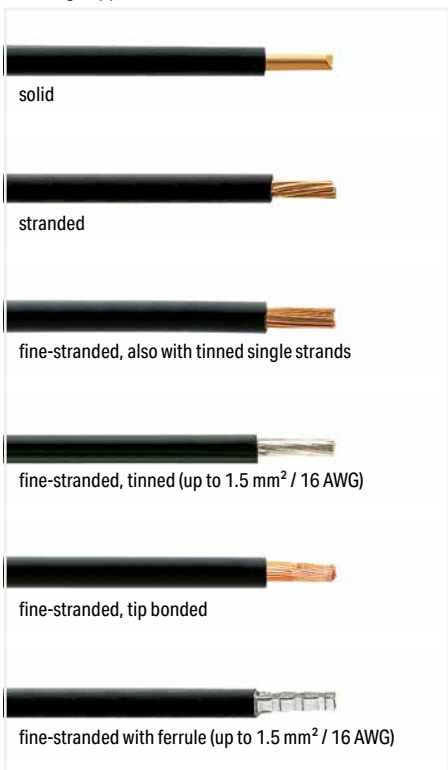

13



To connect: Insert stripped solid conductor into circular entry and push until it hits the backstop.

Installation side



PUSH WIRE® terminates the following copper conductors:
solid "s"

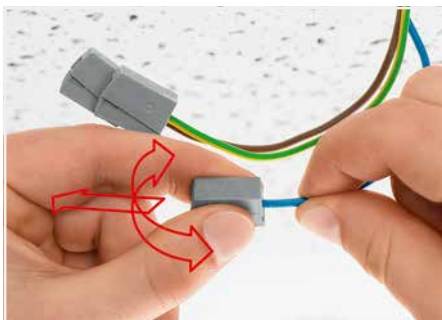

To remove: Hold conductor to be removed and twist alternately left and right while slightly pulling the connector.



Testing via separate test ports.

Lighting Connector and Service Connector 2.5 mm², 224 Series

Technical Data	
Installation side	
1 ... 2.5 mm ² "s"	14 ... 12 AWG
Lighting side	
0.5 ... 2.5 mm ² "s+f-st"	20 ... 16 AWG
400 V/4 kV/2	300 V, 20 AⓈ
I _N 24 A	300 V, 20 AⓈ
9 ... 11 mm / 0.35 ... 0.43 inch	

Technical Data	
Installation side	
1 ... 2.5 mm ² "s"	16 ... 14 AWG
Lighting side	
0.5 ... 2.5 mm ² "s+f-st"	20 ... 16 AWG
400 V/4 kV/2	300 V, 20 AⓈ
I _N 24 A	300 V, 20 AⓈ
9 ... 11 mm / 0.35 ... 0.43 inch	

Technical Data	
0.5 ... 2.5 mm ² "s+f-st"	20 ... 16 AWG
400 V/4 kV/2	300 V, 20 AⓈ
I _N 24 A	
9 ... 11 mm / 0.35 ... 0.43 inch	



Dimensions in mm

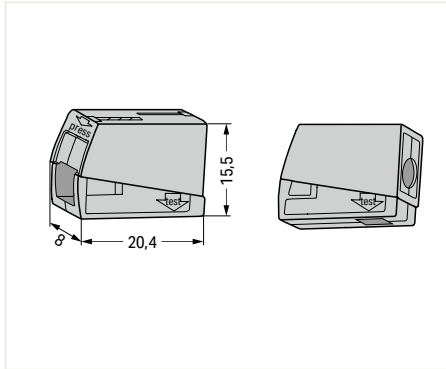

Dimensions in mm

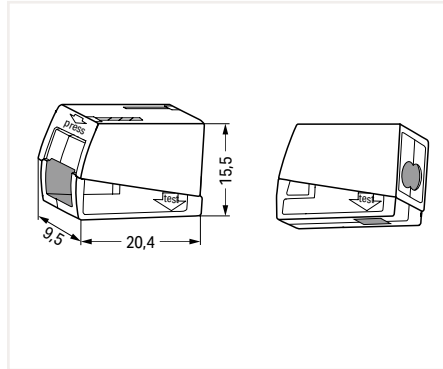

Dimensions in mm

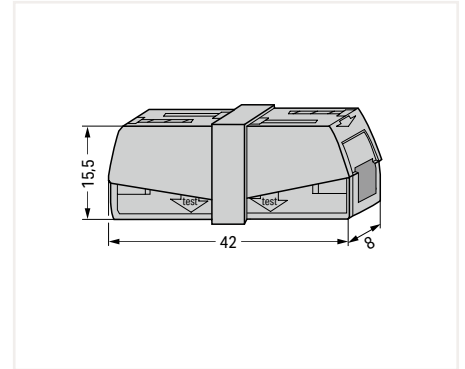

Lighting connector; Standard version; continuous operating temperature (max.): 105 °C; surrounding air temperature (max.): 60 °C

Color	Item No.	Pack. Unit
○ gray	224-101	1000 (100)

2-wire lighting connector; Standard version; continuous operating temperature (max.): 105 °C; surrounding air temperature (max.): 60 °C

Color	Item No.	Pack. Unit
○ white	224-112	1000 (100)

Service connector

Color	Item No.	Pack. Unit
○ gray	224-201	50

Lighting connector; Version for increased continuous operating temperature: 120 °C; surrounding air temperature (max.): 75 °C

● black	224-104	100
---------	---------	-----

2-wire lighting connector; Version for increased continuous operating temperature: 120 °C; surrounding air temperature (max.): 75 °C

● black	224-114	100
---------	---------	-----

Accessories; 224 Series

Syringe; contains 20 ml "Alu-Plus" Contact Paste

249-130	20 (5)
---------	--------



Splicing Connector Set 887 Series



Splicing connector set; Vario-T-BOXX; 222, 224, 243, 2273 Series

Item No.	Pack. Unit
887-910	1

Contains:

- CLASSIC splicing connector; 0.08 ... 4 mm²; gray
- 50 x 3-conductor 222-413
 - 40 x 5-conductor 222-415

- Lighting connector; 1 ... 2.5 mm² "s"; gray
- 100 x 224-101

- MICRO PUSH WIRE® connector for junction boxes; Ø 0.6 ... 0.8 mm

- 100 x 4-conductor (dark gray) 243-204
- 100 x 4-conductor (red) 243-804
- 50 x 8-conductor (dark gray) 243-208

- COMPACT splicing connector; 0.5 ... 2.5 mm²

- 100 x 2-conductor (white) 2273-202
- 100 x 3-conductor (orange) 2273-203
- 100 x 5-conductor (yellow) 2273-205
- 50 x 8-conductor (light gray) 2273-208

- Mounting carrier; for 6 connectors; orange
- 10 x 243-113



Splicing connector set; Vario-T-BOXX; 221, 224, 243, 773, 2273 Series

Item No.	Pack. Unit
887-912	1

Contains:

- COMPACT splicing connector; 0.2 ... 4 mm²; transparent
- 50 x 3-conductor 221-413
 - 25 x 5-conductor 221-415

- 2-conductor lighting connector; 1 ... 2.5 mm² "s"; white
- 100 x 224-112

- MICRO PUSH WIRE® connector for junction boxes; Ø 0.6 ... 0.8 mm

- 100 x 4-conductor (dark gray) 243-204
- 100 x 4-conductor (red) 243-804
- 50 x 8-conductor (dark gray) 243-208

- COMPACT splicing connector; 0.5 ... 2.5 mm²

- 100 x 3-conductor (orange) 2273-203
- 100 x 5-conductor (yellow) 2273-205
- 50 x 8-conductor (light gray) 2273-208

- PUSH WIRE® connector for junction boxes; 1.5 ... 4 mm² "s"; red

- 100 x 4-conductor 773-604

- Mounting carrier; for 6 connectors; orange
- 10 x 243-113



Splicing connector set; L-BOXX® 102; 221, 224, 243, 773, 2273 Series

Item No.	Pack. Unit
887-925	1

Contains:

- COMPACT splicing connector; 0.2 ... 4 mm²; transparent
- 100 x 2-conductor 221-412
 - 50 x 3-conductor 221-413
 - 25 x 5-conductor 221-415

- 2-conductor lighting connector; 1 ... 2.5 mm² "s"; white
- 100 x 224-112

- MICRO PUSH WIRE® connector for junction boxes; Ø 0.6 ... 0.8 mm

- 100 x 4-conductor (dark gray) 243-204
- 50 x 8-conductor (dark gray) 243-208

- COMPACT splicing connector; 0.5 ... 2.5 mm²

- 100 x 3-conductor (orange) 2273-203
- 100 x 5-conductor (yellow) 2273-205
- 50 x 8-conductor (light gray) 2273-208

- PUSH WIRE® connector for junction boxes; 2.5 ... 6 mm² "s"; red

- 100 x 4-conductor 773-173

- Mounting carrier; for 2-, 3- and 5-wire splicing connectors (4 mm²); orange
- 4 x 221-500



Splicing connector set; L-BOXX® 102; 221 Series – 4 mm² & 6 mm²

Item No.	Pack. Unit
887-928	1

Contains:

- COMPACT splicing connector; 0.2 ... 4 mm²; transparent
- 100 x 2-conductor 221-412
 - 250 x 3-conductor 221-413
 - 25 x 5-conductor 221-415

- COMPACT splicing connector; 0.5 ... 6 mm²; transparent
- 30 x 3-conductor 221-613

- Mounting carrier; for 2-, 3- and 5-wire splicing connectors (4 mm²); orange
- 10 x 221-500



Splicing connector set; L-BOXX® 102; 221, 2273 Series

Item No.	Pack. Unit
887-926	1

Contains:

COMPACT splicing connector; 0.2 ... 4 mm²; transparent

- 100 x 2-conductor 221-412
- 100 x 3-conductor 221-413
- 25 x 5-conductor 221-415

COMPACT splicing connector; 0.5 ... 2.5 mm²

- 100 x 2-conductor (white) 2273-202
- 100 x 3-conductor (orange) 2273-203
- 100 x 4-conductor (red) 2273-204
- 100 x 5-conductor (yellow) 2273-205
- 50 x 8-conductor (light gray) 2273-208

Mounting carrier; for 2-, 3- and 5-wire splicing connectors (4 mm²); orange

- 2 x 221-500

Mounting carrier; for single- and double-row connectors; orange

- 2 x 2273-500



Splicing connector set; L-BOXX® 102; 221 Series

Item No.	Pack. Unit
887-927	1

Contains:

COMPACT splicing connector; 0.2 ... 4 mm²; transparent

- 100 x 2-conductor 221-412
- 250 x 3-conductor 221-413
- 50 x 5-conductor 221-415

Mounting carrier; for 2-, 3- and 5-wire splicing connectors (4 mm²); orange

- 10 x 221-500

Splicing connector set; L-BOXX® 102; 221 Series – 4 mm² & 6 mm²

Item No.	Pack. Unit
887-931	1

Contains:

COMPACT splicing connector; 0.2 ... 4 mm²; transparent

- 100 x 2-conductor 221-412
- 250 x 3-conductor 221-413
- 50 x 5-conductor 221-415

COMPACT splicing connector; 0.5 ... 6 mm²; transparent

- 50 x 2-conductor 221-612
- 30 x 3-conductor 221-613
- 5 x 5-conductor 221-615

Mounting carrier; for 2-, 3- and 5-wire splicing connectors (4 mm²); orange

- 2 x 221-500

Mounting carrier; for 2-, 3- and 5-wire splicing connectors (6 mm²); orange

- 2 x 221-510

Splicing Connector Set 887 Series



Splicing connector set; L-BOXX MICRO; 221, 2273 Series

Item No.	Pack. Unit
887-802	1

Contains:

- COMPACT splicing connector; 0.2 ... 4 mm²; transparent
- 10 x 2-conductor 221-412
 - 20 x 3-conductor 221-413
 - 8 x 5-conductor 221-415

COMPACT splicing connector; 0.5 ... 2.5 mm²

- 50 x 3-conductor (orange) 2273-203
- 20 x 5-conductor (yellow) 2273-205
- 12 x 8-conductor (light gray) 2273-208

Mounting carrier; for 2-, 3- and 5-wire splicing connectors (4 mm²); orange

- 1 x 221-500

Mounting carrier; for single- and double-row connectors; orange

- 1 x 2273-500



Splicing connector set; L-BOXX® Mini; 221 Series

Item No.	Pack. Unit
887-952	1

Contains:

- COMPACT splicing connector; 0.2 ... 4 mm²; transparent
- 100 x 2-conductor 221-412
 - 100 x 3-conductor 221-413
 - 25 x 5-conductor 221-415

Mounting carrier; for 2-, 3- and 5-wire splicing connectors (4 mm²); orange

- 4 x 221-500



Splicing connector set; L-BOXX® Mini; 2273 Series

Item No.	Pack. Unit
887-953	1

Contains:

- COMPACT splicing connector; 0.5 ... 2.5 mm²
- 100 x 2-conductor (white) 2273-202
 - 100 x 3-conductor (orange) 2273-203
 - 100 x 4-conductor (red) 2273-204
 - 75 x 5-conductor (yellow) 2273-205
 - 25 x 8-conductor (light gray) 2273-208

Mounting carrier; for single- and double-row connectors; orange

- 4 x 2273-500



Splicing connector set; L-BOXX® Mini; 221, 2273, 224 Series

Item No.	Pack. Unit
887-960	1

Contains:

- COMPACT splicing connector; 0.2 ... 4 mm²; transparent
- 20 x 2-conductor 221-412
 - 15 x 3-conductor 221-413
 - 10 x 5-conductor 221-415

COMPACT splicing connector; 0.5 ... 6 mm²; transparent

- 5 x 3-conductor 221-613

2-conductor lighting connector; 1 ... 2.5 mm² "s"; white

- 15 x 224-112

COMPACT splicing connector; 0.5 ... 2.5 mm²

- 40 x 2-conductor (white) 2273-202
- 30 x 3-conductor (orange) 2273-203
- 25 x 4-conductor (red) 2273-204
- 20 x 5-conductor (yellow) 2273-205
- 15 x 8-conductor (light gray) 2273-208



Splicing connector set; L-BOXX® Mini; 221, 2273 Series

Item No.	Pack. Unit
887-955	1

Contains:

COMPACT splicing connector; 0.2 ... 4 mm²; transparent

- 75 x 2-conductor 221-412
- 50 x 3-conductor 221-413
- 25 x 5-conductor 221-415

COMPACT splicing connector; 0.5 ... 2.5 mm²

- 100 x 3-conductor (orange) 2273-203
- 75 x 5-conductor (yellow) 2273-205
- 25 x 8-conductor (light gray) 2273-208

Mounting carrier; for 2-, 3- and 5-wire splicing connectors (4 mm²); orange

- 1 x 221-500

Mounting carrier; for single- and double-row connectors; orange

- 1 x 2273-500

Splicing connector set; L-BOXX® Mini; 221 Series – 4 mm² & 6 mm²

Item No.	Pack. Unit
887-957	1

Contains:

COMPACT splicing connector; 0.2 ... 4 mm²; transparent

- 75 x 2-conductor 221-412
- 50 x 3-conductor 221-413
- 25 x 5-conductor 221-415

COMPACT splicing connector; 0.5 ... 6 mm²; transparent

- 40 x 2-conductor 221-612
- 30 x 3-conductor 221-613
- 15 x 5-conductor 221-615

Mounting carrier; for 2-, 3- and 5-wire splicing connectors (4 mm²); orange

- 1 x 221-500

Splicing connector set; L-BOXX® Mini; 221 Series – 4 mm² & 6 mm²

Item No.	Pack. Unit
887-959	1

Contains:

COMPACT splicing connector; 0.2 ... 4 mm²; transparent

- 100 x 2-conductor 221-412
- 100 x 3-conductor 221-413
- 25 x 5-conductor 221-415

COMPACT splicing connector; 0.5 ... 6 mm²; transparent



- 30 x 3-conductor 221-613

Mounting carrier; for 2-, 3- and 5-wire splicing connectors (4 mm²); orange

- 1 x 221-500

PUSH WIRE®

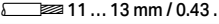
Luminaire Disconnect Connector (U.S. Version) 12 AWG; 873 Series

Technical Data	
2-conductor plug ①	1-conductor socket ②
18 ... 12 AWG "s"	18 AWG "s"
16 ... 12 AWG "st"	600 V, 6 A
 11 ... 13 mm / 0.43 ... 0.51 inch ①	
 9 ... 11 mm / 0.35 ... 0.43 inch ②	

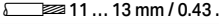
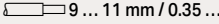
Technical Data	
2-conductor plug ①	1-conductor socket ②
18 ... 12 AWG "s"	18 AWG "s"
16 ... 12 AWG "st"	600 V, 6 A
 11 ... 13 mm / 0.43 ... 0.51 inch ①	
 9 ... 11 mm / 0.35 ... 0.43 inch ②	

- ① 2-conductor plug
 - ② 1-conductor socket
- Approvals and corresponding ratings, visit www.wago.com

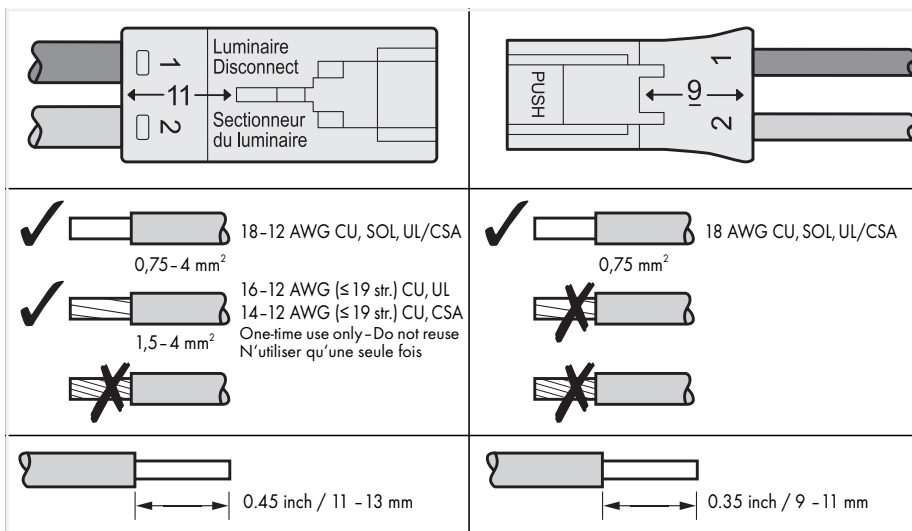
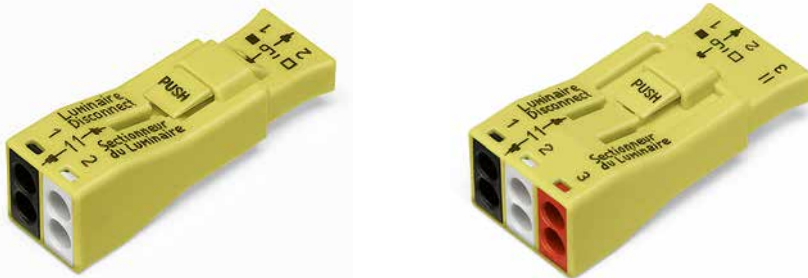

Touchproof connectors are required for ballast supply cables in the USA and Canada. When exchanging a ballast:

1. The touch-proof plug-in connection is disconnected first.
2. The ballast is replaced.
3. Network connection is restored by plugging the connection.

Reconnection streamlines ballast replacement while enhancing safety by safeguarding the installer from electric shock. The 873 Series is approved according to UL 2459 and CSA 22.2 for this type of application.

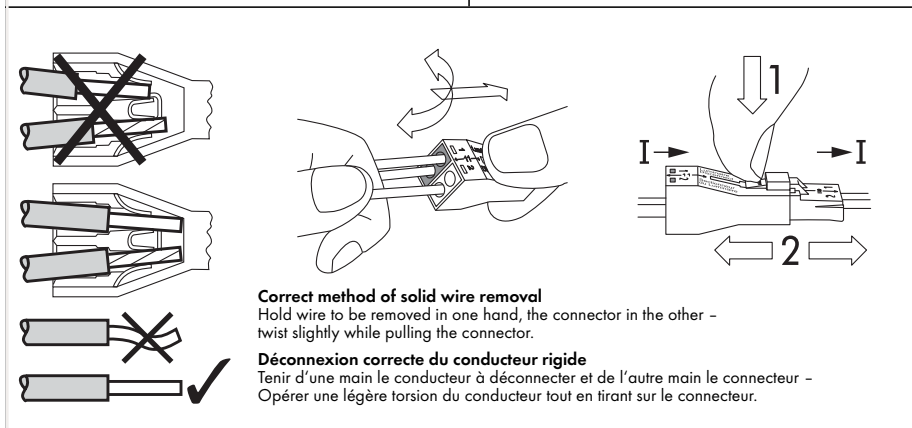

873 Series approvals per EN 60998 and EN 61984:

EN 60998
0.75 mm² (solid), 6 A for socket
1.5 ... 4 mm² (solid), 32 A for plug
400 V / 4 kV / 2

EN 61984
0.75 mm² (solid), 6 A for socket
0.75 ... 4 mm² (solid), 32 A for plug
400 V / 4 kV / 2



Luminaire Disconnect Connectors		
Pole No.	Item No.	Pack. Unit
2	873-902	400

Luminaire Disconnect Connectors		
Pole No.	Item No.	Pack. Unit
3	873-903	200

13

Luminaire Disconnect Connector (U.S. Version) 12 AWG; 873 Series

Technical Data





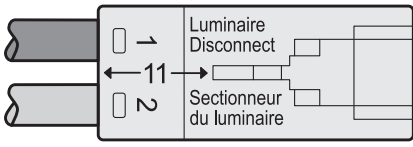

2-conductor plug ①	1-conductor socket ②
18 ... 12 AWG "s"	18 AWG "s"
16 ... 12 AWG "st"	600 V, 6 A
 11 ... 13 mm / 0.43 ... 0.51 inch ①	
 9 ... 11 mm / 0.35 ... 0.43 inch ②	

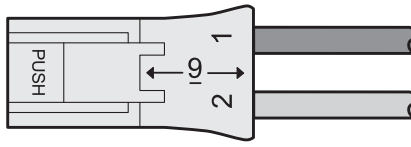
- ① 2-conductor plug
 - ② 1-conductor socket
- Approvals and corresponding ratings, visit www.wago.com





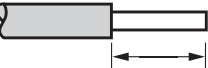
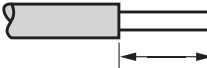

<p>✓  18-12 AWG CU, SOL, UL/CSA 0,75 - 4 mm²</p> <p>✓  16-12 AWG (≤ 19 str.) CU, UL 14-12 AWG (≤ 19 str.) CU, CSA 1,5 - 4 mm² <i>One-time use only - Do not reuse N'utiliser qu'une seule fois</i></p> <p></p>	<p>✓  18 AWG CU, SOL, UL/CSA 0,75 mm²</p> <p></p> <p></p>
<p> 0.45 inch / 11 - 13 mm</p>	<p> 0.35 inch / 9 - 11 mm</p>

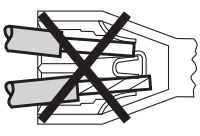

~~Incorrect~~

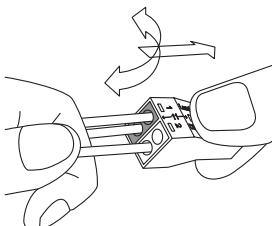

Correct method of solid wire removal
Hold wire to be removed in one hand, the connector in the other - twist slightly while pulling the connector.

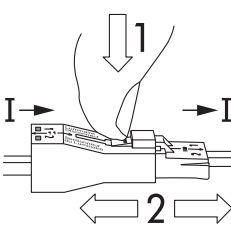

1
I → I
← 2 →

Déconnexion correcte du conducteur rigide
Tenir d'une main le conducteur à déconnecter et de l'autre main le connecteur - Opérer une légère torsion du conducteur tout en tirant sur le connecteur.

Touchproof connectors are required for ballast supply cables in the USA and Canada. When exchanging a ballast:

1. The touch-proof plug-in connection is disconnected first.
2. The ballast is replaced.
3. Network connection is restored by plugging the connection.

Reconnection streamlines ballast replacement while enhancing safety by safeguarding the installer from electric shock. The 873 Series is approved according to UL 2459 and CSA 22.2 for this type of application.

873 Series approvals per EN 60998 and EN 61984:

EN 60998
0.75 mm² (solid), 6 A for socket
1.5 ... 4 mm² (solid), 32 A for plug
400 V / 4 kV / 2













EN 61984
0.75 mm² (solid), 6 A for socket
0.75 ... 4 mm² (solid), 32 A for plug
400 V / 4 kV / 2

Luminaire disconnect connector; with preceding ground contact		
Pole No.	Item No.	Pack. Unit
2	873-953	500



WAGO Accessories and WAGO Tools

WAGO Accessories and WAGO Tools

			Page
	Shield Clamping Saddles	790 Series	624
	Spring-Equipped Shield Clamping Saddles	790 Series	627
	Busbar Carriers	790 Series	629
	Marking Systems		640
	DIN-Rails, Collective Jumper Carriers and Rail-Mount Terminal Block Covers		656
	End Stops for DIN-35 and DIN-15 Rails		658
	Operating tools		664
	Cable Strippers		666
	Crimping Tools for Ferrules		670
	Cable Cutter		676
	"Alu-Plus" Contact Paste		677
	Test and Measurement Devices		678

Shield Connection System

790 Series

Installation



Carrier with grounding foot* (790-113), 45 mm long, busbar 90° to the rail

*for all shield clamping saddle sizes



Carrier with grounding foot* (790-114), 45 mm long, busbar parallel to the rail

*for all shield clamping saddle sizes



Carrier with grounding foot* (790-115), 125 mm long, busbar parallel to the rail

*for all shield clamping saddle sizes

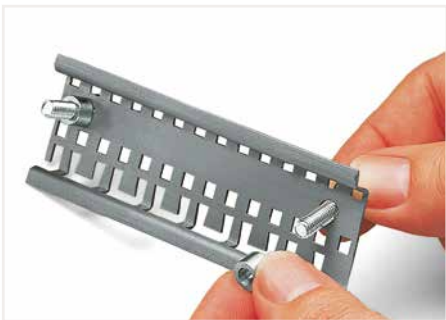

Securing a spacer sleeve to a specialty slotted DIN-rail.



Securing an additional shield clamping saddle.

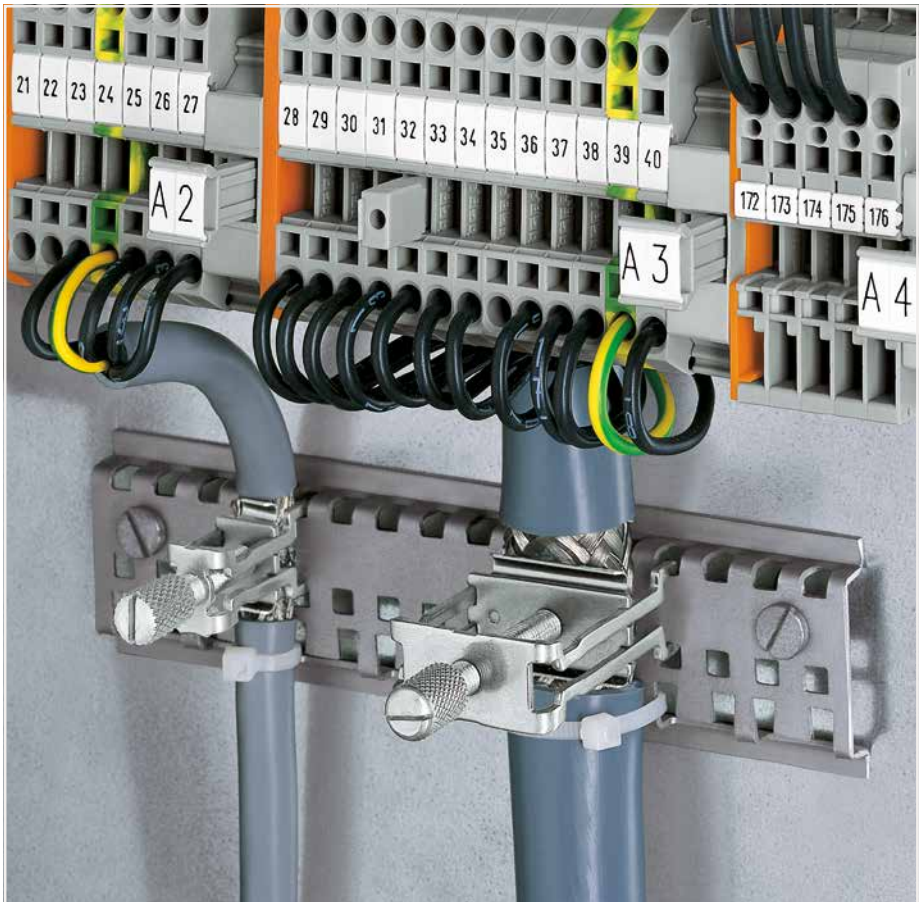

Tightening/removing a shield clamping saddle.



After connection, tighten the knurled screw to complete the installation. Recommended tightening torque: 0.5 Nm



To remove the clamping saddle, unscrew until ratcheted mechanism is released, then slightly tip saddle and remove the clamping saddle.

Shield Connection System

790 Series

Installation

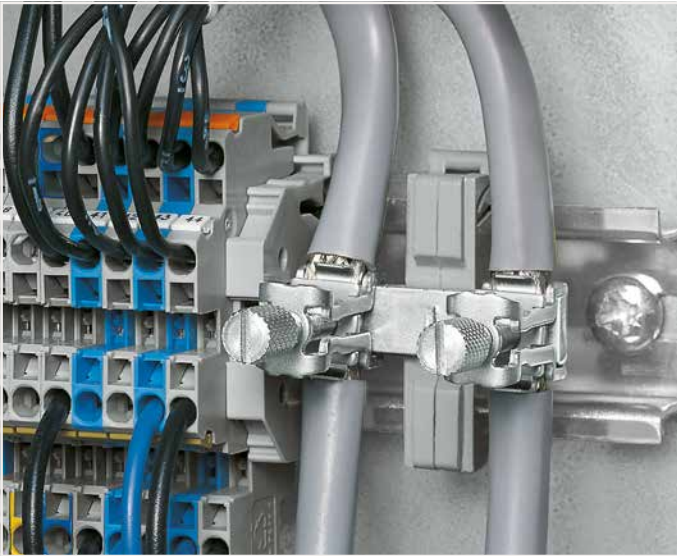

Carrier with grounding foot – busbar parallel to the rail



Insulated mounting carriers for a common shield reference potential, independent of housing potential



U-shaped (10 x 3) mm copper busbar



Snap shield clamping saddles into any metal plate (max. thickness: 3 mm).

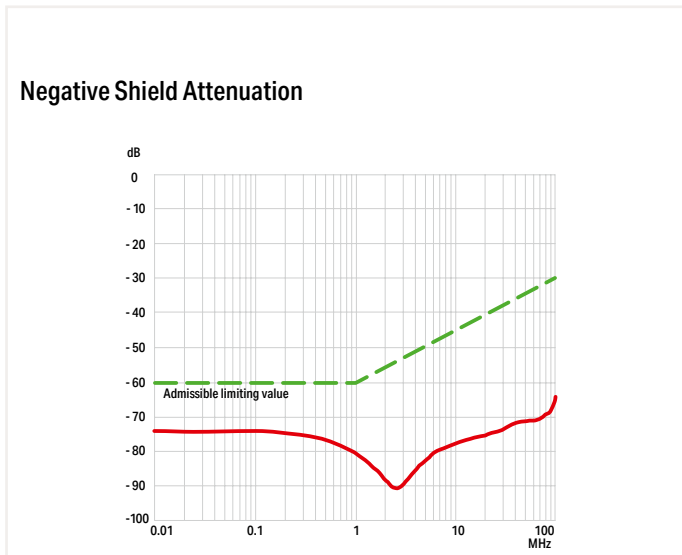

The shield connection system is highly effective because the clamping unit can be brought very close to the unshielded part of the cable.

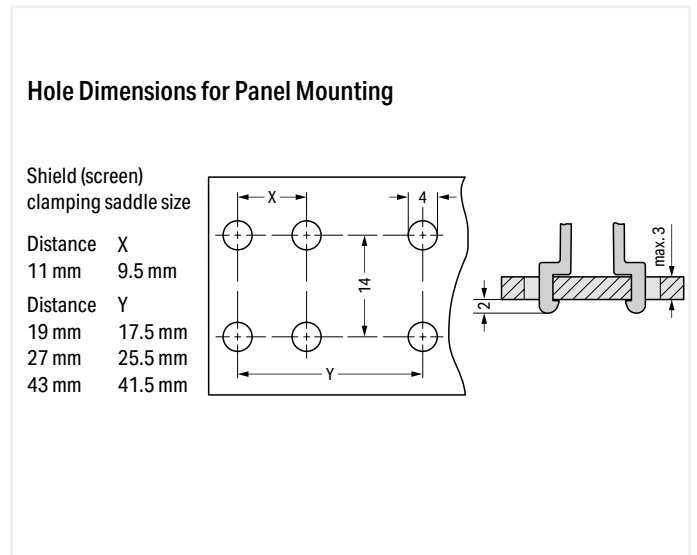

Additionally, the spring material is part of the clamping saddle, providing a good electrical connection (the system also acts as a partial strain relief). The spring element integrated in the shield clamping saddle compensates for deformation and settling that results from a connected shield.

Shield Clamping Saddles 790 Series

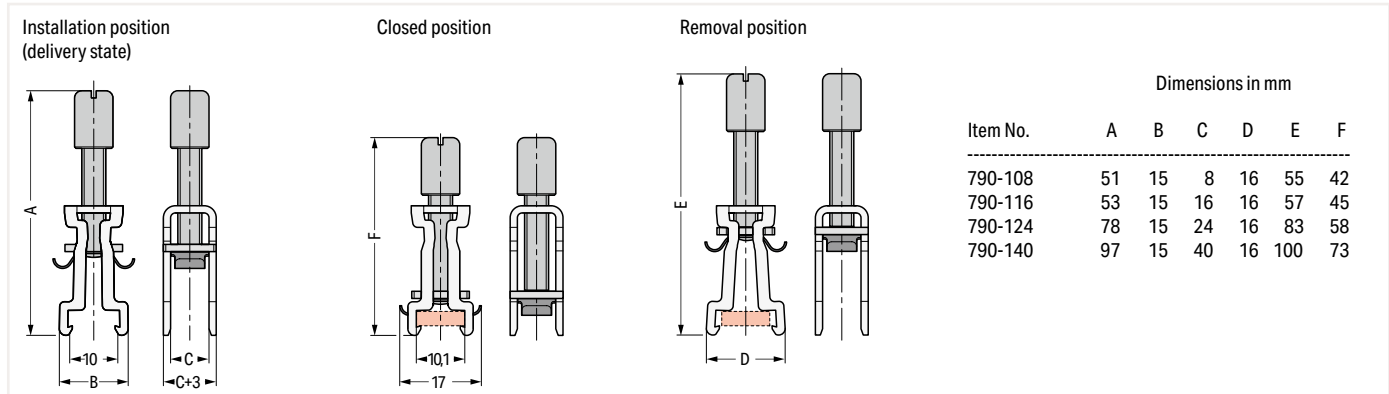

Item No.	Dimensions in mm					
	A	B	C	D	E	F
790-108	51	15	8	16	55	42
790-116	53	15	16	16	57	45
790-124	78	15	24	16	83	58
790-140	97	15	40	16	100	73

Shield clamping saddle; 11 mm wide; Connectable shield diameter: 3 ... 8 mm
 Note: Cannot be used for connecting ground conductors!

Item No.	Pack. Unit
790-108	50 (10)

Shield clamping saddle; 19 mm wide; Connectable shield diameter: 7 ... 16 mm
 Note: Cannot be used for connecting ground conductors!

Item No.	Pack. Unit
790-116	50 (10)

Shield clamping saddle; 27 mm wide; Connectable shield diameter: 6 ... 24 mm
 Note: Cannot be used for connecting ground conductors!

Item No.	Pack. Unit
790-124	50 (10)

Accessories; for Shield Clamping Saddles

Carrier with grounding foot; Busbar parallel to the rail; 15 mm long; Copper (10 x 3) mm; for shield clamping saddles (790-108)

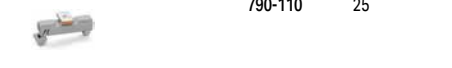

790-110 25

Carrier with grounding foot; Busbar parallel to the rail; 25 mm long; Copper (10 x 3) mm; for shield clamping saddles (790-108; 790-116) and shield clamps (791-111; 791-117)

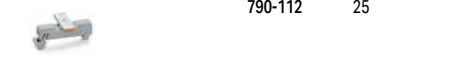

790-112 25

Carrier with grounding foot; Busbar 90° to the DIN-rail; 45 mm long; Copper (10 x 3) mm; for shield clamping saddles (790 Series)

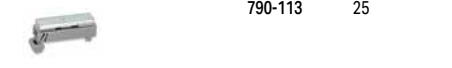

790-113 25

Carrier with grounding foot; Busbar parallel to the DIN-rail; 45 mm long; Copper (10 x 3) mm; for shield clamping saddles (790 Series) and shield clamps (791 Series)



790-114 25

Carrier with two grounding feet; Busbar parallel to the DIN-rail; 125 mm long; Copper (10 x 3) mm



790-115 25

DIN-rail; specialty slotted; 1000 mm long; tin-plated

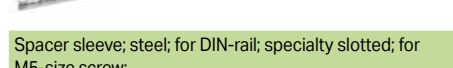

790-145

Spacer sleeve; steel; for DIN-rail; specialty slotted; for M5-size screw;

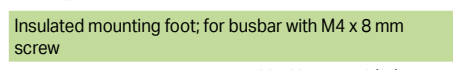

790-144 200 (100)

Insulated mounting foot; for busbar with M4 x 8 mm screw

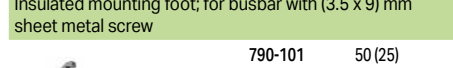

790-100 50 (25)

Insulated mounting foot; for busbar with (3.5 x 9) mm sheet metal screw

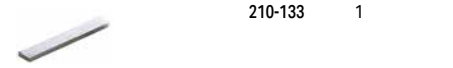

790-101 50 (25)

Busbar; tin-plated; 1000 mm long; copper (10 x 3) mm

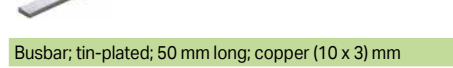

210-133 1

Busbar; tin-plated; 30 mm long; copper (10 x 3) mm



790-133 20

Busbar; tin-plated; 50 mm long; copper (10 x 3) mm



790-134 20

U-shaped busbar; Copper (10 x 3) mm; for 5 I/O; for 750 Series I/O Modules

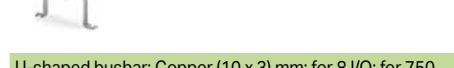

790-190 25 (5)

U-shaped busbar; Copper (10 x 3) mm; for 8 I/O; for 750 Series I/O Modules

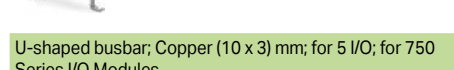

790-191 25

U-shaped busbar; Copper (10 x 3) mm; for 5 I/O; for 750 Series I/O Modules

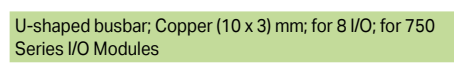

790-192 25

U-shaped busbar; Copper (10 x 3) mm; for 8 I/O; for 750 Series I/O Modules



790-193 25

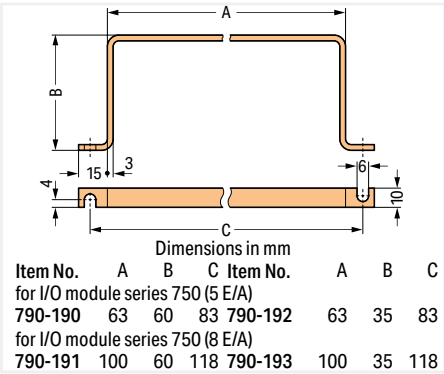

Shield clamping saddle; 43 mm wide; Connectable shield diameter: 22 ... 40 mm
 Note: Cannot be used for connecting ground conductors!

Item No.	Pack. Unit
790-140	50 (10)



Carrier with grounding foot* (790-114), 45 mm long, busbar parallel to the rail



Carrier with grounding foot* (790-115), 125 mm long, busbar parallel to the rail

*for all shield clamping saddle sizes

*for all shield clamping saddle sizes

Spring-Equipped Shield Clamping Saddles

790 Series

Installation



Shield clamping saddles are available in three different sizes for shield diameters ranging from 3 to 20 mm.

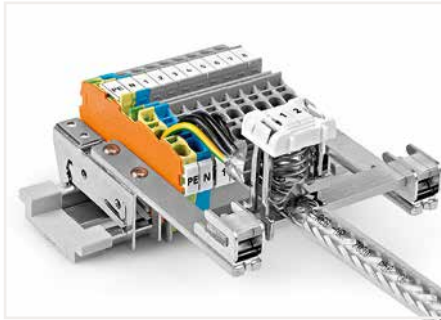

Application example



Compress the clamping saddle until fully engaged.



Mounting a clamping saddle on a specialty slotted DIN-rail (790-145).
When releasing the saddle, do not place your finger under the clamping spring!



Removing the shield clamping saddle.



Shield clamping saddle contacts shield conductor and specialty slotted DIN-rail (790-145).



Labeling using a marking strip.



Labelling using WMB markers.

Spring-Equipped Shield Clamping Saddles 790 Series



Delivery position		Mounting position		Dimensions in mm				
Item No.	A	B	C	D	E*			
790-208	30	29.9	8	12.4	25.8			
790-216	34.6	28.3	16	21.8	30.2			
790-220	45.6	28.3	24	30	41.2			

*Height with WMB marker

Shield clamping saddle; 12.4 mm wide; Connectable shield diameter: 3 ... 8 mm
Note: Cannot be used for connecting ground conductors and strain relief!

Item No.	Pack. Unit
790-208	50

Shield clamping saddle; 21.8 mm wide; Connectable shield diameter: 6 ... 16 mm
Note: Cannot be used for connecting ground conductors and strain relief!

Item No.	Pack. Unit
790-216	25

Shield clamping saddle; 30 mm wide; Connectable shield diameter: 6 ... 20 mm
Note: Cannot be used for connecting ground conductors and strain relief!

Item No.	Pack. Unit
790-220	25

Accessories; for Shield Clamping Saddles

Carrier with grounding foot; Busbar parallel to the rail; 15 mm long; Copper (10 x 3) mm; for shield clamping saddles (790-108)

Item No.	Pack. Unit
790-110	25

Carrier with grounding foot; Busbar parallel to the rail; 25 mm long; Copper (10 x 3) mm; for shield clamping saddles (790-108; 790-116) and shield clamps (791-111; 791-117)

Item No.	Pack. Unit
790-112	25

Carrier with grounding foot; Busbar 90° to the DIN-rail; 45 mm long; Copper (10 x 3) mm; for shield clamping saddles (790 Series)

Item No.	Pack. Unit
790-113	25

Carrier with grounding foot; Busbar parallel to the DIN-rail; 45 mm long; Copper (10 x 3) mm; for shield clamping saddles (790 Series) and shield clamps (791 Series)

Item No.	Pack. Unit
790-114	25

Carrier with two grounding feet; Busbar parallel to the DIN-rail; 125 mm long; Copper (10 x 3) mm

Item No.	Pack. Unit
790-115	25

DIN-rail; specialty slotted; 1000 mm long; tin-plated

Item No.	Pack. Unit
790-145	

Spacer sleeve; steel; for DIN-rail; specialty slotted; for M5-size screw;

Item No.	Pack. Unit
790-144	200 (100)

Busbar; tin-plated; 1000 mm long; copper (10 x 3) mm

Item No.	Pack. Unit
210-133	1

Busbar; tin-plated; 30 mm long; copper (10 x 3) mm

Item No.	Pack. Unit
790-133	20

Busbar; tin-plated; 50 mm long; copper (10 x 3) mm

Item No.	Pack. Unit
790-134	20

Shield Clamp and Shield Termination 791 and 709 Series



Dimensions in mm

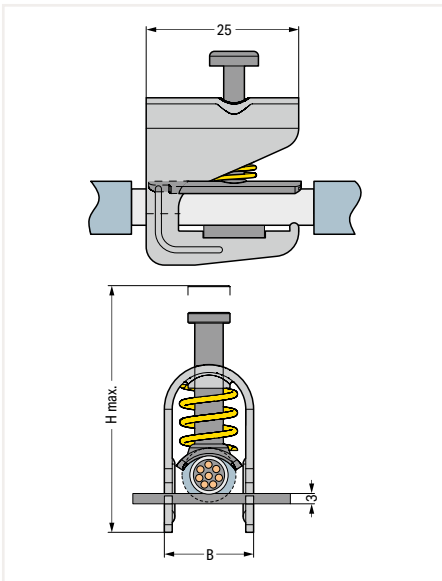

Shield clamp; Connectable shield diameter: 1.5 ... 6.5 mm; Height (max.): 40 mm; 10 mm wide
Note: Cannot be used for connecting ground conductors!

Item No.	Pack. Unit
791-107	50

Shield clamp; Connectable shield diameter: 5 ... 11 mm; Height (max.): 47 mm; 17 mm wide
Note: Cannot be used for connecting ground conductors!

791-111	50
---------	----

Shield clamp; Connectable shield diameter: 10 ... 17 mm; Height (max.): 63 mm; 23 mm wide
Note: Cannot be used for connecting ground conductors!

791-117	50
---------	----

Shield clamp; Connectable shield diameter: 16 ... 24 mm; Height (max.): 78 mm; 30 mm wide
Note: Cannot be used for connecting ground conductors!

791-124	50
---------	----

Shield termination; includes cable ties for 5 ... 10 mm shield diameter; 60 mm long

Item No.	Pack. Unit
709-350	100 (25)

Shield termination; includes cable ties for 5 ... 10 mm shield diameter; 150 mm long

709-352	100 (25)
---------	----------



Fit the shield termination to the shield cable.



Secure both shield cable and shield termination to the strain relief plate using cable ties.



Shield termination connected to an X-COM® female plug

Busbar Carriers 790 Series

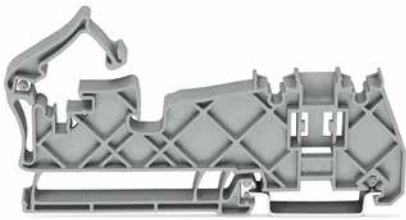

Dimensions in mm

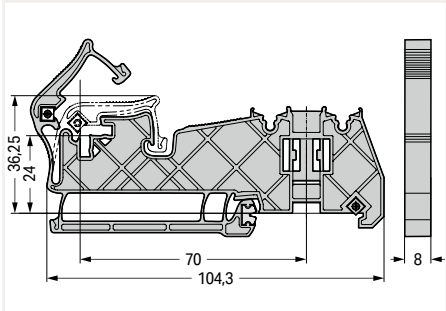

Busbar carrier; for (10 x 3) mm copper busbars; no contact to DIN-rail; insulated

Item No.	Pack. Unit
790-400	20



Snapping the busbar carrier onto DIN-35 rail.



Vertical mounting position of the busbar



Place the busbar in the carrier holder.



Horizontal mounting position of the busbar



Snap the mounting bracket into position.



Release the mounting bracket by pushing the operating tool down ① and then forward ②.

Busbar Carriers

790 Series



Dimensions in mm

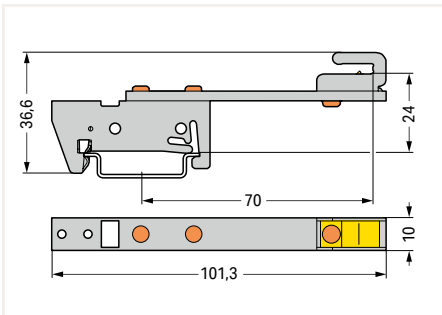

Busbar carrier; for (10 x 3) mm copper busbars; single side; straight; 70 mm between center of DIN-rail and busbar carrier

Item No.	Pack. Unit
790-300	10

Dimensions in mm

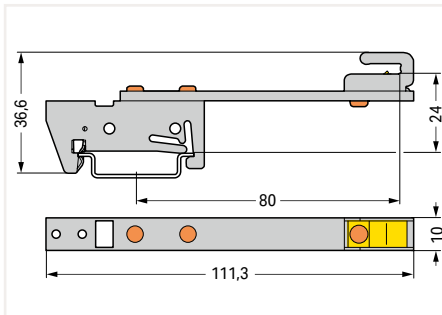

Busbar carrier; for (10 x 3) mm copper busbars; single side; straight; 80 mm between center of DIN-rail and busbar carrier

Item No.	Pack. Unit
790-302	10

Dimensions in mm

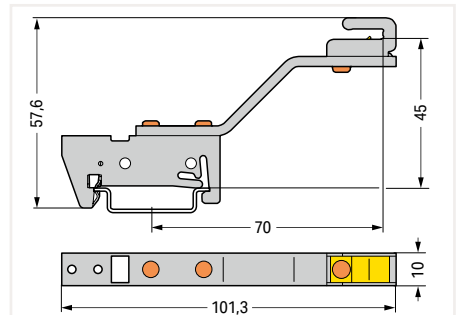

Busbar carrier; for (10 x 3) mm copper busbars; single side; angled; 70 mm between center of DIN-rail and busbar carrier

Item No.	Pack. Unit
790-301	10



Remove the busbar carrier using an operating tool (type 3, 5.5 x 0.8 mm blade).

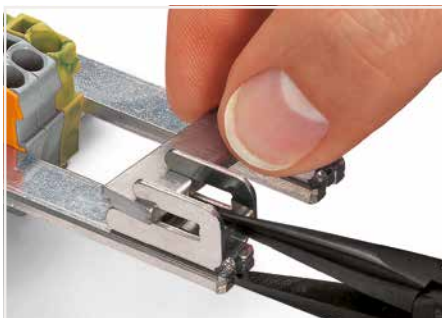

To remove the busbar, compress the spring using pliers.



Place the busbar in the busbar carrier.

Busbar Carriers

790 Series



Dimensions in mm

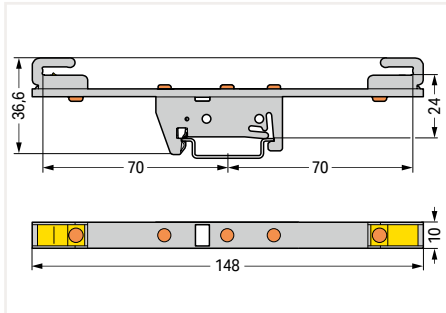

Busbar carrier; for (10 x 3) mm copper busbars; both sides; straight; 70 mm between center of DIN-rail and busbar carrier

Item No.	Pack. Unit
790-310	10

Dimensions in mm

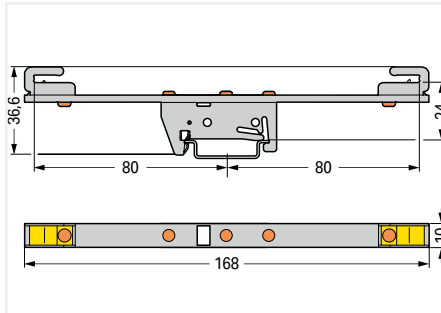

Busbar carrier; for (10 x 3) mm copper busbars; both sides; straight; 80 mm between center of DIN-rail and busbar carrier

Item No.	Pack. Unit
790-312	10

Dimensions in mm

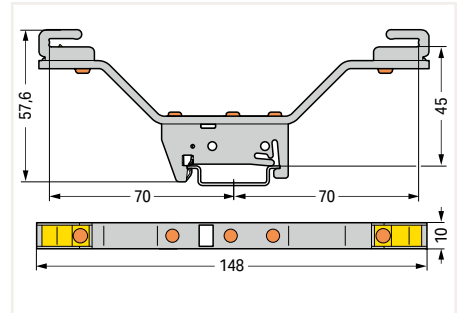

Busbar carrier; for (10 x 3) mm copper busbars; both sides; angled; 70 mm between center of DIN-rail and busbar carrier

Item No.	Pack. Unit
790-311	10

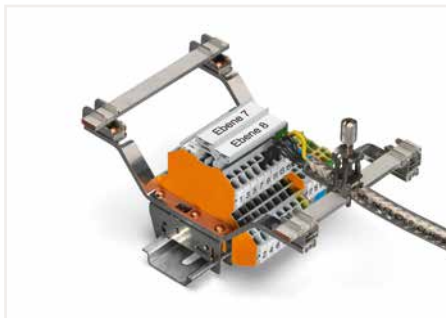

Application example

Busbar Carrier with a T-Connector (Flexible) and T-Connector 790 Series

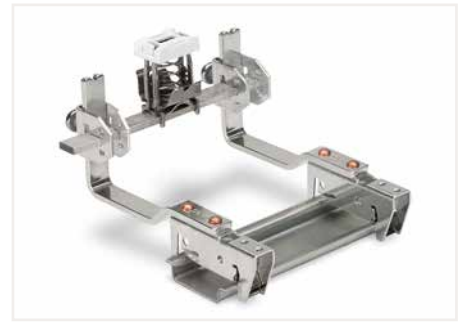

Dimensions in mm

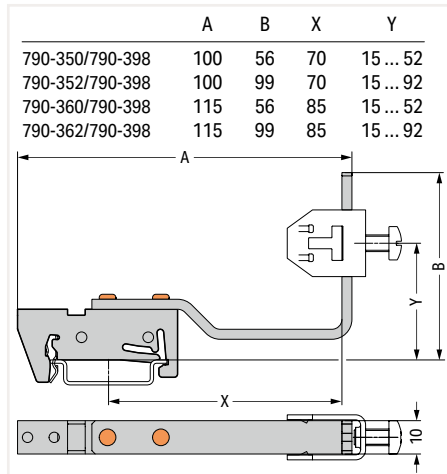

Dimensions in mm

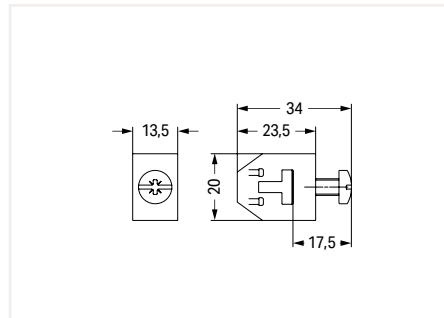

Horizontal mounting position of the busbar



Vertical mounting position of the busbar

Busbar carrier with a T-connector; flexible; for (10 x 3) mm copper busbars; 70 mm between center of DIN-rail and busbar carrier; 56 mm high

	Item No.	Pack. Unit
	790-350/790-398	12

T-connector; connects two (10 x 3) mm copper busbars

	Item No.	Pack. Unit
	790-398	

Busbar carrier with a T-connector; flexible; for (10 x 3) mm copper busbars; 70 mm between center of DIN-rail and busbar carrier; 99 mm high

	790-352/790-398	12
--	-----------------	----

Busbar carrier with a T-connector; flexible; for (10 x 3) mm copper busbars; 85 mm between center of DIN-rail and busbar carrier; 56 mm high

	790-360/790-398	12
--	-----------------	----

Busbar carrier with a T-connector; flexible; for (10 x 3) mm copper busbars; 85 mm between center of DIN-rail and busbar carrier; 99 mm high

	790-362/790-398	12
--	-----------------	----

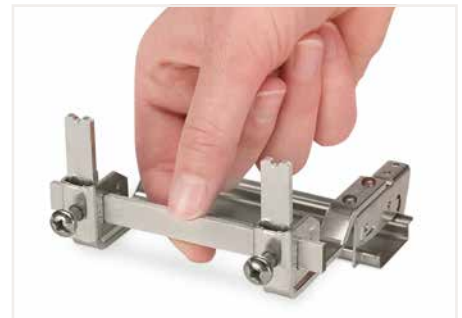

The height of the busbar can be adjusted.



Secure the busbar by tightening the screws at the required position.

Smart Data

Supports Workflow from Control Cabinet Planning to Installation

Electrical Planning
 Directly import data from a CAE circuit diagram into the Smart Designer engineering software or output marking data on Smart Printer

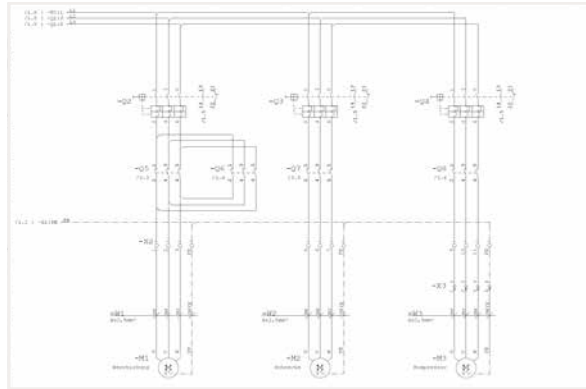

Technical and Commercial Item Data
 Classified by ETIM and eCl@ss – also in Advanced Format



Mechanical Planning
 CAD export into all standard CAD formats and in different granularities



Smart Designer

- Free online configuration and ordering software for all electrical interconnect and automation components
- No installation required
- Available worldwide – 24 hours a day
- Item data is always updated
- Auto-audit feature checks product compatibility via programmed database
- Design in full 3-D

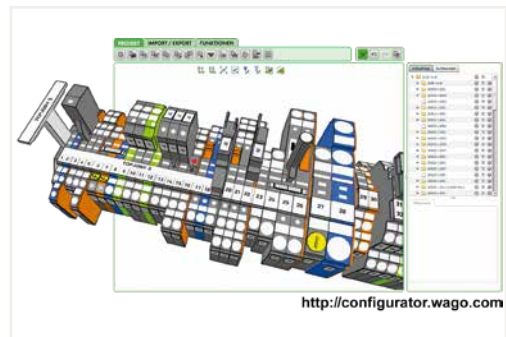

Smart Script

- XML-based software for all WAGO labeling materials
- Data import from CAE systems
- Font size check
- Material selection wizard



Configuration made easy – <http://configurator.wago.com>

Smart Printer

The Fastest Marking System



Smart Script



www.wago.com/printer

Smart Script
Import from CAE systems or create customized marking.

Smart Designer

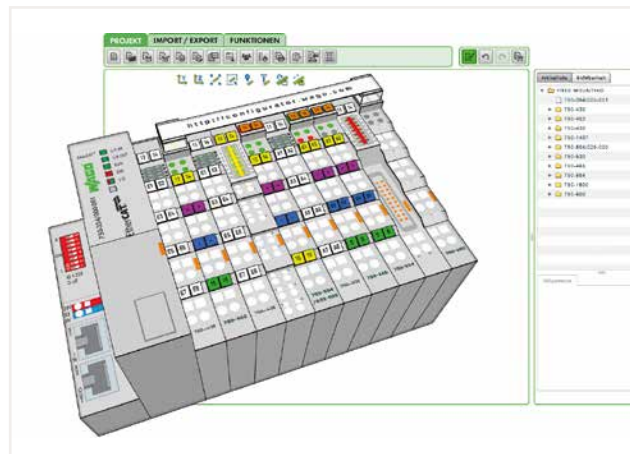

Smart Designer
After designing, print labeling materials directly from the project via Smart Printer



- Smart Printer**
- Compact and easy-to-use
 - Quickly print and install marking strips
 - Cost-effective marking from beginning to end

Terminal Block Marking

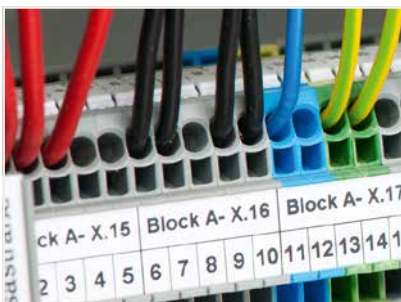

Multi-line marking strips for clear, detailed control cabinet labels

- WMB Inline markers on a reel are suitable for various terminal block sizes – just one marker size for all standard applications
- Same profile across all WAGO Rail-Mount Terminal Blocks TOPJOB® S ensures quick labeling

Cable and Conductor Marking



Different versions available:

- Marking sleeves, self-laminating labels, conductor markers for thread-on mounting or shrink tubes
- Large variety of marking surface sizes

Device Marking

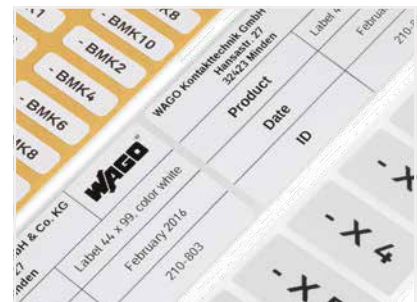

Broad selection of label types (e.g., printable fabric), push-button markers and type plates optimizes marking for devices and control cabinets

- Labels and markers are available in a variety of colors and sizes

Marking Systems

Description and Installation



Separating a strip from the WMB or WMB marker card.



Stretching a WMB marker strip.



Separating an individual marker from the strip – for larger terminal blocks.



Marking via Mini-WSB Quick Marking System.

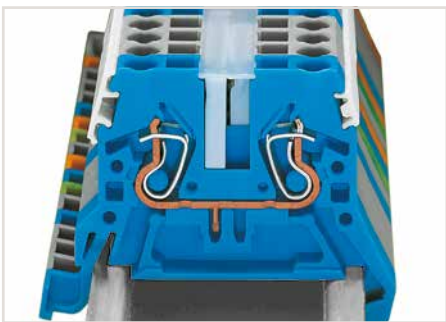

WMB markers in Mini-WSB marker slots
Translucent marking strip
Mini-WSB markers

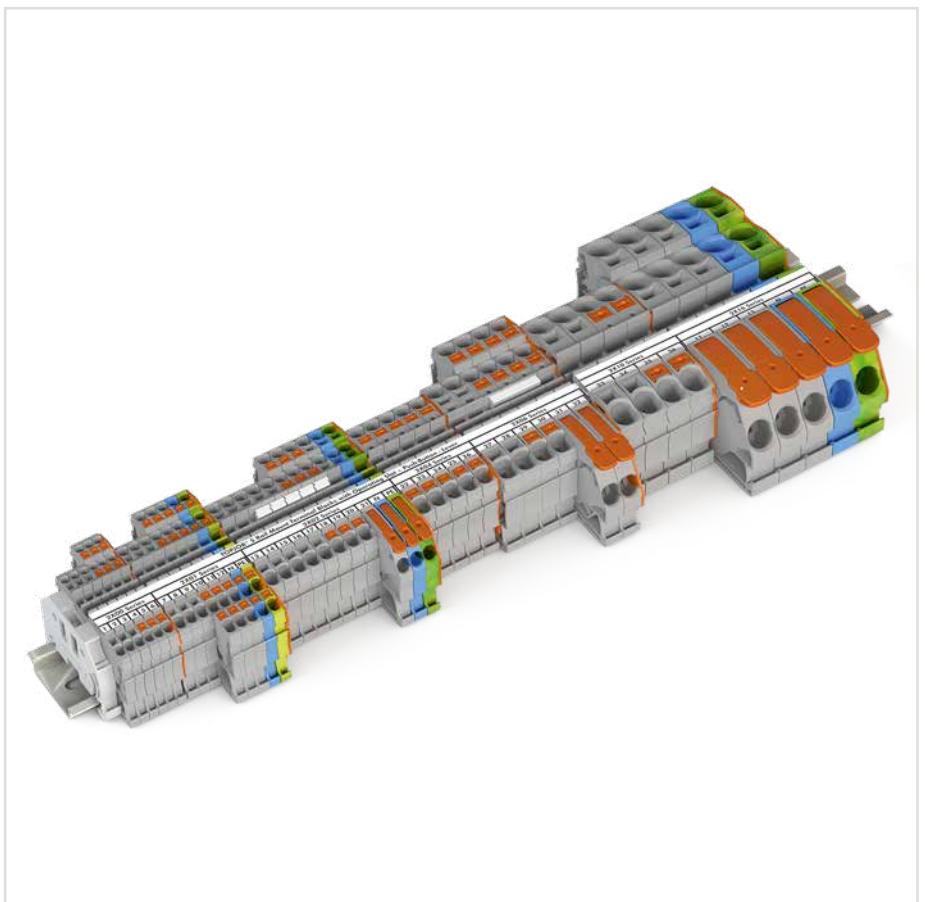

Printing a marking strip (2009-110) via Smart Printer.

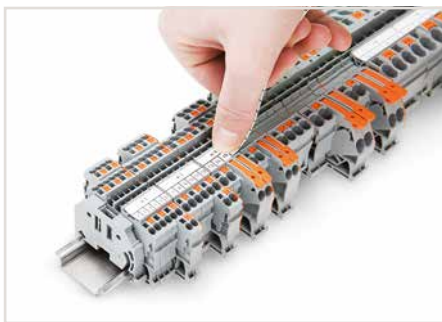

Snapping a marking strip into the marker slot.

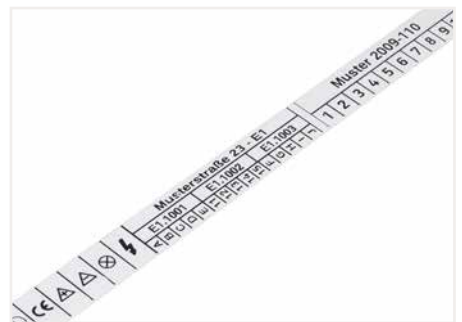

Marking strip – multi-line printing



Snapping a marking strip into the marker slot.



Snapping a WMB strip into the marker slot of the double marker carrier.



WMB "decade" marking

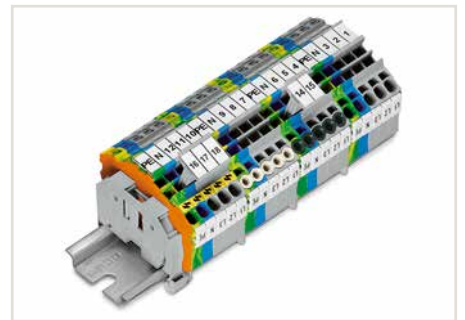

Group marker carriers for WAGO Rail-Mount Terminal Blocks TOPJOB® S – can be snapped into jumper slots.

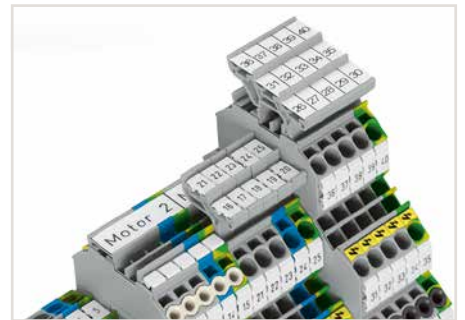

Double- and triple-deck marker carriers can be retrofitted into the jumper contact slot of double- and triple-deck terminal blocks.



Height adjustable group marker carrier (2009-163) for marking strips (2009-110)



Height-adjustable group marker carrier



Additional group marking

Marking System

Terminal Block Width: 3.5 mm, 4 ... 4.2 mm and from 5 mm

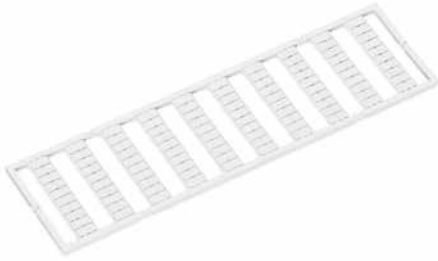

Use		
Marker width	Can be snapped onto the following terminal block series	
	for continuous marking	that will be separated
3.5 mm	2000, 2020	-
4 ... 4.2 mm	279, 2001	-
5 ... 5.2 mm	270, 280, 780, 869, 870, 880, 2002, 2003, 2022	Terminal blocks with spacing > 5 ... 5.2 mm
5 ... 17.5 mm	270, 280, 780, 869, 870, 880	281 ... 285, 781 ... 785, 2002, 2004, 2005, 2006, 2007, 2010, 2016, 2022

WMB marker card; plain; 10 strips with 10 markers/card					
Color	5 mm Item No.	5 ... 5.2 mm Item No.	4 ... 4.2 mm Item No.	3.5 mm Item No.	Pack. Unit
○ white	793-501	793-5501	793-4501	793-3501	5
● yellow	793-501/000-002	793-5501/000-002	793-4501/000-002		5
● red	793-501/000-005	793-5501/000-005	793-4501/000-005		5
● blue	793-501/000-006	793-5501/000-006	793-4501/000-006		5
○ gray	793-501/000-007	793-5501/000-007	793-4501/000-007		5
● orange	793-501/000-012	793-5501/000-012	793-4501/000-012		5
● light green	793-501/000-017	793-5501/000-017	793-4501/000-017		5
● green	793-501/000-023	793-5501/000-023	793-4501/000-023		5
● violet	793-501/000-024	793-5501/000-024	793-4501/000-024		5



Use		
Marker width	Can be snapped onto the following terminal block series	
	for continuous marking	that will be separated
3.5 mm	2000, 2020	-
4 ... 4.2 mm	279, 2001	-
5 ... 5.2 mm	270, 280, 780, 869, 870, 880, 2002, 2003, 2022	Terminal blocks with spacing > 5 ... 5.2 mm

WMB Inline; plain; 2,300 WMB markers (3.5 mm)/reel		
Color	3.5 mm Item No.	Pack. Unit
○ white	2009-113	1

WMB Inline; plain; 2,000 WMB markers (4 mm)/reel; stretchable 4 ... 4.2 mm		
Color	4 ... 4.2 mm Item No.	Pack. Unit
○ white	2009-114	1

WMB Inline; plain; 1,500 WMB markers (5 mm)/reel; stretchable 5 ... 5.2 mm		
Color	5 ... 5.2 mm Item No.	Pack. Unit
○ white	2009-115	1



Use		
	Can be snapped onto the following terminal block series	
	2000, 2001, 2002, 2003, 2004, 2005, 2006, 2007, 2010, 2016, 2020, 2022	

Marking strip; plain; 11 mm wide; 50 m reel		
Color	Item No.	Pack. Unit
○ white	2009-110	1

Mini-WSB Quick Marking System

Terminal Block Width: 5 mm

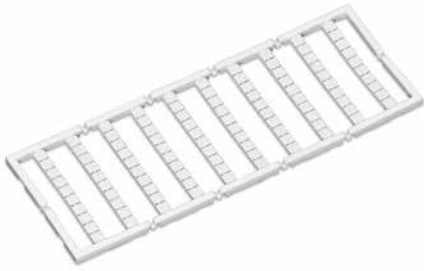

Use		
Marker width	Can be snapped onto the following terminal block series	
	for continuous marking	that will be separated
5 mm	264, 270, 869, 880, 769, 870, 218, 233 ... 236, 243, 250, 252 ... 257, 735 ... 742, 745, 746, 804, 805, 806, 816, 831, 750, 753, 2002, 2003, 2022	745, 746, 2004, 2006, 2007, 2010, 2016

Mini-WSB marker card; plain; 10 strips with 10 markers/card		
Color	Item No.	Pack. Unit
<input type="radio"/> white	248-501	5
<input type="radio"/> yellow	248-501/000-002	5
<input type="radio"/> red	248-501/000-005	5
<input type="radio"/> blue	248-501/000-006	5
<input type="radio"/> gray	248-501/000-007	5
<input type="radio"/> orange	248-501/000-012	5
<input type="radio"/> light green	248-501/000-017	5
<input type="radio"/> green	248-501/000-023	5
<input type="radio"/> violet	248-501/000-024	5

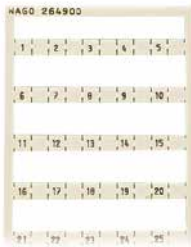

Mini-WSB marker card; with marking; not stretchable; horizontal marking; snap-on type		
Marking	Item No.	Pack. Unit
<input type="radio"/> 1, , 2, , 3, , 4, , 5, ; to 46, , 47, , 48, , 49, , 50, ; (each 1x)	264-900	5
<input type="radio"/> U, , V, , W, , N, , PE, ; (10x)	264-901	5
<input type="radio"/> L1, , L2, , L3, , N, , PE, ; (10x)	264-902	5
<input type="radio"/> 1, , 1, , 1, , 1, , 1, ; (10x)	264-903	5
<input type="radio"/> 2, , 2, , 2, , 2, , 2, ; (10x)	264-904	5
<input type="radio"/> 3, , 3, , 3, , 3, , 3, ; (10x)	264-905	5



Use		
Marker width	Can be snapped onto the following terminal block series	
	for continuous marking	that will be separated
5 mm	264, 270, 869, 880, 769, 870, 218, 233 ... 236, 243, 250, 252 ... 257, 735 ... 742, 745, 746, 804, 805, 806, 816, 831, 750, 753, 2002, 2003, 2022	745, 746, 2004, 2005, 2006, 2007, 2010, 2016

Mini-WSB Inline; plain; 1,700 markers (5 mm)/reel; stretchable 5 ... 5.2 mm		
Color	Item No.	Pack. Unit
<input type="radio"/> white	2009-145	1

Marking Card; Self-Adhesive Marking Strips



- Strip length: 182 mm

Marking strip; plain; as DIN A4 sheet		
	Item No.	Pack. Unit
<input type="radio"/> Strip height: 2.3 mm; 100 self-adhesive strips per card	210-331	100
<input type="radio"/> Strip height: 3 mm; 80 self-adhesive strips per card	210-332	100
<input type="radio"/> Strip height: 5 mm; 48 self-adhesive strips per card	210-334	100
<input type="radio"/> Strip height: 6 mm; 40 self-adhesive strips per card	210-333	100
<input type="radio"/> Strip height: 9 mm; 25 self-adhesive strips per card	210-335	100

- Horizontal marking
- Strip length: 182 mm
- Strip height: 6 mm



Marking strip; as DIN A4 sheet; for 2-conductor terminal strips (260 Series)		
Marking	Item No.	Pack. Unit
<input type="radio"/> 1 ... 10 (120 x)	210-333/500-002	100
<input type="radio"/> 11 ... 20 (120 x)	210-333/500-003	100
<input type="radio"/> 21 ... 30 (120 x)	210-333/500-004	100
<input type="radio"/> 31 ... 40 (120 x)	210-333/500-005	100
<input type="radio"/> 41 ... 50 (120 x)	210-333/500-006	100
<input type="radio"/> 51 ... 60 (120 x)	210-333/500-007	100
<input type="radio"/> 61 ... 70 (120 x)	210-333/500-008	100
<input type="radio"/> 71 ... 80 (120 x)	210-333/500-009	100
<input type="radio"/> 81 ... 90 (120 x)	210-333/500-010	100
<input type="radio"/> 91 ... 100 (120 x)	210-333/500-011	100
<input type="radio"/> 1 ... 50 (20 x)	210-333/500-021	100
<input type="radio"/> L1 (1440 x)	210-333/500-074	100
<input type="radio"/> L2 (1440 x)	210-333/500-075	100
<input type="radio"/> L3 (1440 x)	210-333/500-076	100
<input type="radio"/> N (1440 x)	210-333/500-077	100
<input type="radio"/> PE (1440 x)	210-333/500-078	100
<input type="radio"/> PEN (1440 x)	210-333/500-079	100
<input type="radio"/> only grid spacing	210-333/500-001	100

Marking strip; for 4-conductor terminal strips (260 Series)		
<input type="radio"/> 1 ... 10 (80 x)	210-333/800-002	100
<input type="radio"/> 11 ... 20 (80 x)	210-333/800-003	100
<input type="radio"/> 21 ... 30 (80 x)	210-333/800-004	100
<input type="radio"/> 31 ... 40 (80 x)	210-333/800-005	100
<input type="radio"/> 41 ... 50 (80 x)	210-333/800-006	100
<input type="radio"/> 51 ... 60 (80 x)	210-333/800-007	100
<input type="radio"/> 61 ... 70 (80 x)	210-333/800-008	100
<input type="radio"/> 71 ... 80 (80 x)	210-333/800-009	100
<input type="radio"/> 81 ... 90 (80 x)	210-333/800-010	100
<input type="radio"/> 91 ... 100 (80 x)	210-333/800-011	100
<input type="radio"/> 1 ... 40 (20 x)	210-333/800-209	100
<input type="radio"/> L1 (880 x)	210-333/800-074	100
<input type="radio"/> L2 (880 x)	210-333/800-075	100
<input type="radio"/> L3 (880 x)	210-333/800-076	100
<input type="radio"/> N (880 x)	210-333/800-077	100
<input type="radio"/> PE (880 x)	210-333/800-078	100
<input type="radio"/> PEN (880 x)	210-333/800-079	100
<input type="radio"/> only grid spacing	210-333/800-001	100

Marking Card; Self-Adhesive Marking Strips

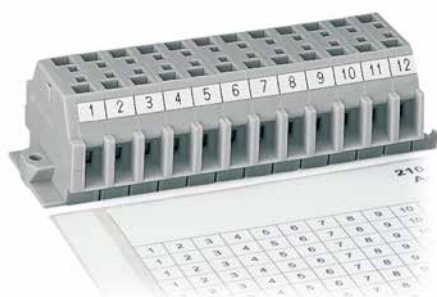

- Horizontal marking
- Strip length: 182 mm
- Strip height: 6 mm

Marking strip; as DIN A4 sheet; for 2-conductor terminal strips (261 Series)

Marking	Item No.	Pack. Unit
<input type="radio"/> 1 ... 12 (80 x)	210-333/600-103	100
<input type="radio"/> 13 ... 24 (80 x)	210-333/600-104	100
<input type="radio"/> 25 ... 36 (80 x)	210-333/600-105	100
<input type="radio"/> 37 ... 48 (80 x)	210-333/600-106	100
<input type="radio"/> 41 ... 50 (80 x)	210-333/600-006	100
<input type="radio"/> 51 ... 60 (80 x)	210-333/600-007	100
<input type="radio"/> 61 ... 70 (80 x)	210-333/600-008	100
<input type="radio"/> 71 ... 80 (80 x)	210-333/600-009	100
<input type="radio"/> 81 ... 90 (80 x)	210-333/600-010	100
<input type="radio"/> 91 ... 100 (80 x)	210-333/600-011	100
<input type="radio"/> 1 ... 50 (20 x)	210-333/600-021	100
<input type="radio"/> L1 (1200 x)	210-333/600-074	100
<input type="radio"/> L2 (1200 x)	210-333/600-075	100
<input type="radio"/> L3 (1200 x)	210-333/600-076	100
<input type="radio"/> N (1200 x)	210-333/600-077	100
<input type="radio"/> PE (1200 x)	210-333/600-078	100
<input type="radio"/> PEN (1200 x)	210-333/600-079	100
<input type="radio"/> only grid spacing	210-333/600-001	100

Marking strip; for 4-conductor terminal strips (261 Series)

<input type="radio"/> 1 ... 16 (40 x)	210-333/1000-202	100
<input type="radio"/> 17 ... 32 (40 x)	210-333/1000-204	100
<input type="radio"/> 33 ... 48 (40 x)	210-333/1000-206	100
<input type="radio"/> 49 ... 64 (40 x)	210-333/1000-110	100
<input type="radio"/> 65 ... 80 (40 x)	210-333/1000-111	100
<input type="radio"/> 81 ... 96 (40 x)	210-333/1000-112	100
<input type="radio"/> 97 ... 112 (40 x)	210-333/1000-113	100
<input type="radio"/> 1 ... 36 (20 x)	210-333/1000-208	100
<input type="radio"/> L1 (720 x)	210-333/1000-074	100
<input type="radio"/> L2 (720 x)	210-333/1000-075	100
<input type="radio"/> L3 (720 x)	210-333/1000-076	100
<input type="radio"/> N (720 x)	210-333/1000-077	100
<input type="radio"/> PE (720 x)	210-333/1000-078	100
<input type="radio"/> PEN (720 x)	210-333/1000-079	100
<input type="radio"/> only grid spacing	210-333/1000-001	100

Marking Card; Self-Adhesive Marking Strips

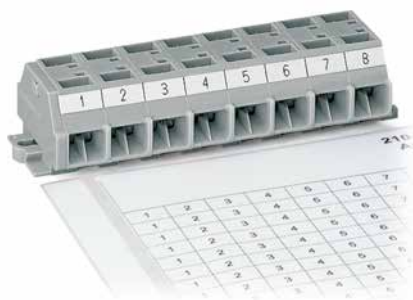

- Horizontal marking
- Strip length: 182 mm
- Strip height: 6 mm

Marking strip; as DIN A4 sheet; for 2-conductor terminal strips (262 Series)

Marking	Item No.	Pack. Unit
<input type="radio"/> 1 ... 20 (40 x)	210-333/700-020	100
<input type="radio"/> 21 ... 40 (40 x)	210-333/700-108	100
<input type="radio"/> 41 ... 60 (40 x)	210-333/700-109	100
<input type="radio"/> 1 ... 50 (20 x)	210-333/700-021	100
<input type="radio"/> L1 (1040 x)	210-333/700-074	100
<input type="radio"/> L2 (1040 x)	210-333/700-075	100
<input type="radio"/> L3 (1040 x)	210-333/700-076	100
<input type="radio"/> N (1040 x)	210-333/700-077	100
<input type="radio"/> PE (1040 x)	210-333/700-078	100
<input type="radio"/> PEN (1040 x)	210-333/700-079	100
<input type="radio"/> only grid spacing	210-333/700-001	100

Marking strip; for 4-conductor terminal strips (262 Series)

<input type="radio"/> 1 ... 12 (40 x)	210-333/1200-103	100
<input type="radio"/> 13 ... 24 (40 x)	210-333/1200-104	100
<input type="radio"/> 25 ... 36 (40 x)	210-333/1200-105	100
<input type="radio"/> 37 ... 48 (40 x)	210-333/1200-106	100
<input type="radio"/> 49 ... 60 (40 x)	210-333/1200-107	100
<input type="radio"/> 1 ... 24 (20 x)	210-333/1200-203	100
<input type="radio"/> L1 (600 x)	210-333/1200-074	100
<input type="radio"/> L2 (600 x)	210-333/1200-075	100
<input type="radio"/> L3 (600 x)	210-333/1200-076	100
<input type="radio"/> N (600 x)	210-333/1200-077	100
<input type="radio"/> PE (600 x)	210-333/1200-078	100
<input type="radio"/> PEN (600 x)	210-333/1200-079	100
<input type="radio"/> only grid spacing	210-333/1200-001	100

Group Marker Carrier and Marker Carrier TOPJOB® S



Group marker carrier; snap-on type for jumper slot; gray

	Item No.	Pack. Unit
○ 5 mm wide	2009-191	50 (25)
○ 10 mm wide	2009-192	50 (25)
○ 15 mm wide	2009-193	50 (25)

Marker carrier; for lateral marker slots; 5 mm wide

Color	Item No.	Pack. Unit
○ gray	2009-198	200 (25)

2009-193 Group Marker Carrier (equipped with marking strips) for all 2001 to 2016 Series TOPJOB® S Rail-Mount Terminal Blocks.

Do not use on an end plate!

Group marker carrier; snap-on type for jumper slot; gray

○ 10 mm wide	2009-196	50 (25)
--------------	----------	---------



Marker carrier; for jumper slots of double-deck, double-disconnect terminal blocks (2002 Series); 5 mm wide

Color	Item No.	Pack. Unit
○ gray	2002-160	50 (25)

Marker carrier; for jumper slots (2002 Series); 5 mm wide

Color	Item No.	Pack. Unit
○ gray	2002-161	100 (25)

Using marker carriers for marking strips (2002-161) in jumper slots.



Using marker carriers for marking strips (2009-198) in lateral marker slots.

Multilevel Marker Carrier TOPJOB® S



Double-deck marker carrier; pivoting		
Color	Item No.	Pack. Unit
○ gray	2000-121	50 (25)

Double-deck marker carrier; pivoting		
Color	Item No.	Pack. Unit
○ gray	2002-121	50 (25)

Triple-deck marker carrier; pivoting		
Color	Item No.	Pack. Unit
○ gray	2002-131	50 (25)

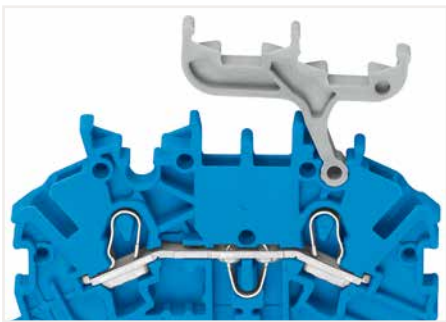

Double-deck terminal blocks:
A double-deck marker carrier (2000-121) can be retrofitted to double-deck terminal blocks without a marker carrier.

Group Marker Carriers (Adjustable in Height) and Laterally Movable Marking System



Group marker carrier; fits into jumper slot of rail-mount terminal blocks; for terminal block width 4 ... 6 mm; for up to 3 WMB markers or 8 branch markers; 15 mm wide

Color	Item No.	Pack. Unit
<input type="radio"/> gray	209-140	50 (25)



Group marker carrier; snaps onto screwless 249-116 and 249-117 End Stops (center or side mounting); 10 mm wide

Color	Item No.	Pack. Unit
<input type="radio"/> white	209-112	50 (25)

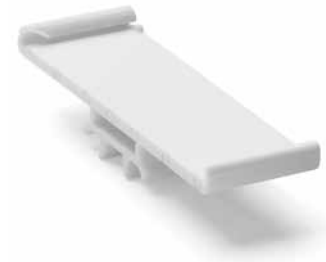

Group marker carrier; for WMB and Mini-WSB marker slots; 10 mm wide

Color	Item No.	Pack. Unit
<input type="radio"/> white	209-145	100 (25)

Group marker carrier; fits into jumper slot of rail-mount terminal blocks; for up to 2 WMB markers or 5 branch markers; 10 mm wide

<input type="radio"/> gray	209-141	50 (25)
----------------------------	---------	---------

Group marker carrier; fits into jumper slot of rail-mount terminal blocks; for up to 1 WMB markers or 2 branch markers; 5 mm wide

<input type="radio"/> gray	209-142	50 (25)
----------------------------	---------	---------

Accessories; item-specific

Marker; from white cardboard; for self-marking; 100 markers/sheet

	white	209-113	1
---	-------	---------	---

Selbstklebeschild; zum Selbstbeschriften; 7 x 25 Stück/Bogen

	white	210-345	1
---	-------	---------	---

Schutzstreifen

	transparent	209-114	50
---	-------------	---------	----



Group marker carriers (209-141 and 209-112)



Group marking on N-busbar carrier used as an end stop



Group marker carrier (209-145)

Group Marker Carriers (Adjustable in Height) and Laterally Movable Marking System



Height-adjustable group marker carrier; snaps onto end stops (249-116 and 249-117), adjustable in height from 43.5 to 59.5 mm; for 1 marker or self-adhesive marker and transparent protection cover; 10 mm wide

Color	Item No.	Pack. Unit
○ gray	249-119	50 (25)



Carrier-through element; height-adjustable; snaps onto end stops (249-116 and 249-117)

Color	Item No.	Pack. Unit
○ gray	709-118	50 (25)

Height-adjustable group marker carrier; snaps onto end stops (249-116 and 249-117), adjustable in height from 43.5 to 59.5 mm; for 2 WMB markers or 1 continuous strip; 10 mm wide

○ gray	249-118	100 (25)
--------	---------	----------

Carrier-end element; height-adjustable; snaps onto end stops (249-116 and 249-117)

○ gray	709-119	50 (25)
--------	---------	---------

Height-adjustable group marker carrier; snaps onto end stops (249-116 and 249-117), adjustable in height from 42.2 to 58.2 mm; with marking surface; 6 mm wide

○ white	249-120	50 (25)
---------	---------	---------

Height-adjustable group marker carrier; snaps onto end stops (249-116 and 249-117), adjustable in height from 45 to 61 mm; for 9 WMB markers or 1 marking strip TOPJOB® S; 12.2 mm wide

○ gray	2009-163	50 (25)
--------	----------	---------

Accessories; item-specific

Marking strip receptacle; folded; 1 m long; 16 mm wide; 1.7 mm thick

transparent	709-120	1
-------------	---------	---

Marking card; with 14 marking strips; DIN A4

	709-193	1
--	---------	---

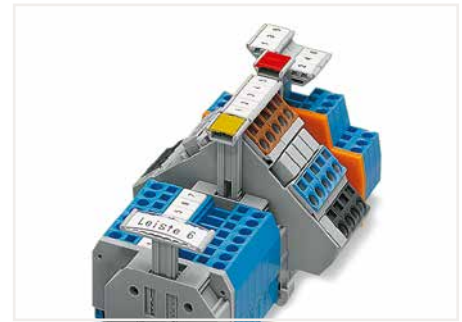

Receptacles for:
 1 x marker
 2 x WMB Multi marker or
 1 x WFB continuous marking strip

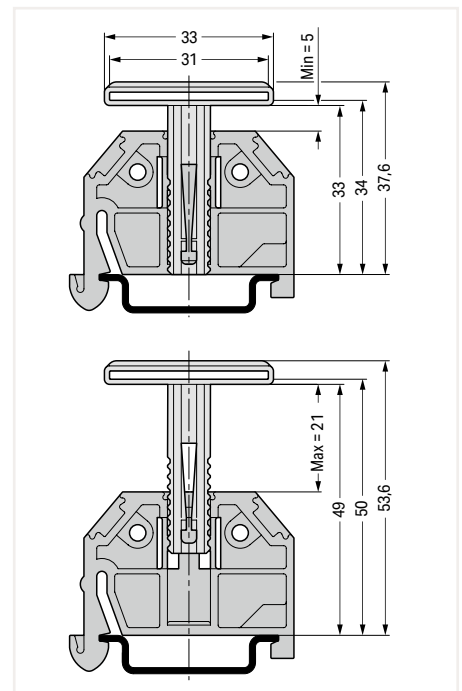

Height adjustable group marker carrier (2009-163) for marking strips (2009-110)



This laterally movable marking system can be used as an additional group marker carrier or continuous marking strip carrier for terminal strips or single-deck rail-mount terminal blocks, e.g., for:

- DIN-35 rail-mount terminal strips (264 Series)
- Single-deck rail-mount terminal blocks (279 to 284 Series) with a maximum height of 49 mm (1.93 inch) from upper-edge of DIN-rail (please observe conductor radius)

Group Marker Carrier and Double Marker Carrier



Group marker carrier; angled; e.g., for transformer terminal blocks (282 Series)

Color	Item No.	Pack. Unit
○ gray	209-144	50 (25)

Double marker carrier; for center I/O module marking; for WSB and WMB marking systems; 4 mm wide

Color	Item No.	Pack. Unit
○ gray	209-128	200 (100)

Group marker carrier; straight; e.g., for 2- and 3-conductor terminal blocks (282 Series)

Color	Item No.	Pack. Unit
○ gray	209-143	50 (25)



This group marker carrier (209-144) makes it possible to mark subgroups in confined places. They can be snapped into unused jumper contact slots of the terminal block housing. Labeling is performed via WMB Multi markers.



Snapping a WMB marker strip into the marker slot of the double marker carrier.

Group Marker Carrier (Pivoting) and WFB Continuous Marking Strip

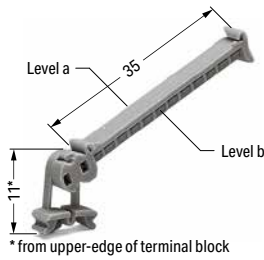

Pivoting group marker carrier

Color	Item No.	Pack. Unit
○ gray	249-105	50 (25)

Zubehör; artikelspezifisch

Marker; 4 x 30 markers/sheet

white	209-183	1
-------	---------	---

Protective marker cover

transparent	209-184	50
-------------	---------	----

Carrier for WFB continuous marking strip; snaps into marker slot

Color	Item No.	Pack. Unit
○ gray	209-185	200 (25)

Accessories; item-specific

WFB continuous marking strip; 1000 mm long; for self-marking; e.g., with felt-tip pen

transparent	210-612	10
-------------	---------	----

Felt-tip pen; for permanent marking

	210-110	200 (1)
--	---------	---------

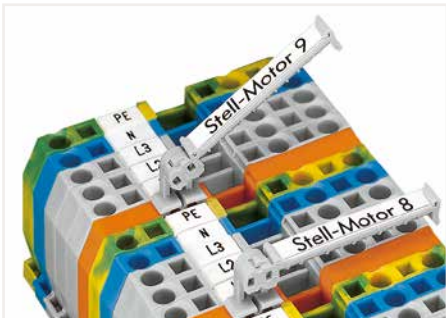

This pivoting group marker carrier has been developed for group marking of rail-mount terminal blocks and incorporates many customer requirements.

- Can be used in all multiprofile marker slots for rail-mount terminal blocks from 5 mm (0.197 inch) on or in spacer housings as shown above.
- Pivotal in seven different stable positions, providing the best visual angle in case of difficult mounting conditions



WFB continuous marking strip
Customized ink pen marking



Carrier for WFB Continuous marking strips, to be fixed every 10th terminal block.

Thermal Transfer Printer Smart Printer



Open the printer.



Printer – open



Accessories for unwinding material



Insert the ink ribbon.



Prepare the marking material.



Insert and secure the appropriate roller into the printer.



Printer has several interfaces:
USB, ETHERNET, serial COM port



Fast, cost-effective and easy to use –
printing WMB Inline markers via Smart Printer

14

Thermal Transfer Printer and Cutter Smart Printer



Smart Printer; WMB Inline markers; Marking strips; Conductor markers and labels; Resolution: 300 dpi

Item No.	Pack. Unit
258-5000	1

Smart Printer

includes:

- Power supply and cable
- USB cable
- 1 x marking strip reel (2009-110)
- 1 x WMB Inline marker reel (2009-115)
- 2 x roller (258-5006 + 258-5007)
- 1 x reel holder
- 1 x ink ribbon (258-5005)

Technical Data

Printing method	Thermal transfer
Print head	Glass layer, spring-mounted
Print speed (max.)	127 mm/s (WAGO recommends 50.8 mm/s)
Print width (max.)	47 mm
Print length (max.)	762 mm
Print resolution	300 dpi (12 pixels/mm)
See-through/reflective sensor	Yes, centrally mounted
Operating display	Color TFT LCD with navigation button
Memory	8 MB Flash, 16 MB SDRAM
Interfaces	USB, RS-232, ETHERNET 10/100 Mbps, USB Host
Operating voltage	100 ... 240 VAC, 50 ... 60 Hz (automatic adjustment)
Dimensions (mm) W x H x D	135 x 175 x 245
Weight	2000 g (without printing material)
Operating temperature	5 ... 40 °C (41 ... 104 °F)
Storage temperature	-20 ... 50 °C (-4 ... 122 °F)
Safety approvals	CE (EMC)
Ink ribbon (see also Full Line Catalog, Volume 6, Marking)	External roll diameter: 40 mm; Internal core diameter: 12.7 mm (0.5 inch); Max. length: 110 m; Max. width: 58 mm



Cutter for Smart Printer; for marking strips only; not suitable for WMB Inline markers

Item No.	Pack. Unit
258-5030	1

Hardware requirements:

- Printer model: Smart Printer
- From manufacturing month/year: 0814 – August 2014
- Firmware version: 1.UW7i
- Printer driver: Version 7.4.2

Software requirements:

- Smart Script: Version 3.88.9.0 or higher
- WAGO printer settings: Version 2.4.0.0 or higher

Approved print material to be cut:

- Marking strips: 2009-110, 709-177, 709-178, 757-901/000-005
- Self-adhesive marking strips: 210-702, 210-870 ... -877
- Cable tie markers: 211-835 ... -836, 211-836/000-002
- Self-laminating labels: 211-855 ... -857
- Conductor markers for thread-on mounting: 211-861 ... -863
- Type labels: 210-801 ... -804, 210-812
- Continuous labels: 210-831 ... -834
- Label for circuit identification: 210-813

Dimensions of printing materials:

- Width (max.): 46 mm
- Thickness (max.): 250 µm

Technical Data

Width	60 mm
Height	107 mm
Depth	131 mm
Weight	1050 g

Control Cabinet Outlet and Switch Cabinet Drawer 709 Series

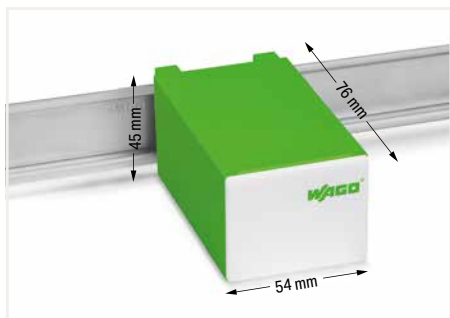

Technical Data

Ratings per	DIN VDE 0620-1
Voltage type	AC
Rated voltage	250 V
Rated surge voltage	2 kV
Rated current	16 A

Connection Data

Connection technology	Push-in CAGE CLAMP®
Actuation type	Type 2 (3.5 x 0.5) mm blade
Actuation direction	Operation parallel to conductor entry
Connectable conductor materials	Copper
Solid conductor	0.2 ... 2.5 mm / 24 ... 14 AWG
Stranded conductor	0.2 ... 2.5 mm / 24 ... 14 AWG
Fine-stranded conductor	0.2 ... 2.5 mm / 24 ... 14 AWG
Strip length	9 ... 10 mm / 0.35 ... 0.39 inch
Number of poles	3

Mechanical Data

Mounting type	DIN-35 rail
Protection type	IP20
Potential marking	L PE N

Material Data

Material group	I
Insulation material	Polyamide 66 (PA 66)
Flammability class per UL94	V0
Clamping spring material	Chrome nickel spring steel (CrNi)
Contact material	Copper alloy
Contact plating	Sn

Environmental Requirements

Continuous operating temperature from	-35 °C
Continuous operating temperature up to	85 °C

- ❶ The outlets are available in three colors to identify different circuits:
- 709-581 gray (standard)
 - 709-582 yellow (permanently energized)
 - 709-583 red (UPS)

Approvals and corresponding ratings,
visit www.wago.com

Control Cabinet Outlet and Switch Cabinet Drawer 709 Series



Dimensions in mm

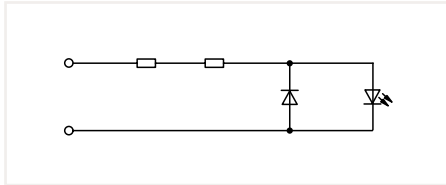
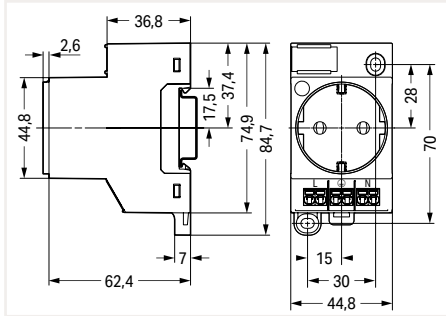

Control cabinet outlet; for DIN-35 rail and screw mounting; for plug Type F, CEE 7/4 (SCHUKO®); used in Germany, the Netherlands, Austria; with status LED; with Push-in CAGE CLAMP® double connection

Color	Item No.	Pack. Unit
○ light gray	709-581 1	1

Dimensions in mm

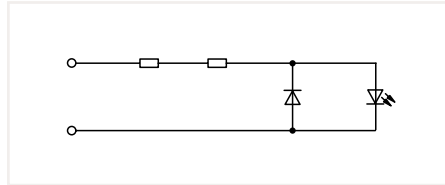
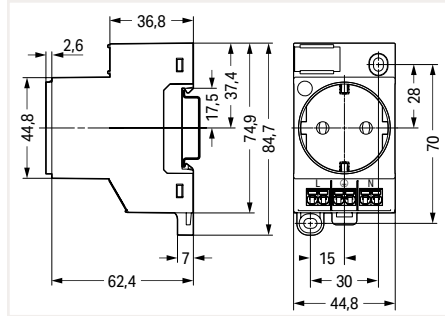

Control cabinet outlet; for DIN-35 rail and screw mounting; for plug Type F, CEE 7/4 (SCHUKO®); used in Germany, the Netherlands, Austria; with status LED; with Push-in CAGE CLAMP® double connection

Color	Item No.	Pack. Unit
● yellow	709-582 1	1

Dimensions in mm

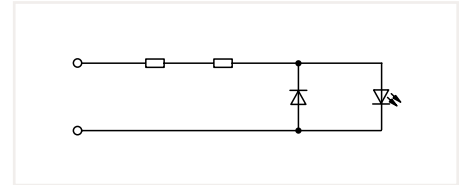
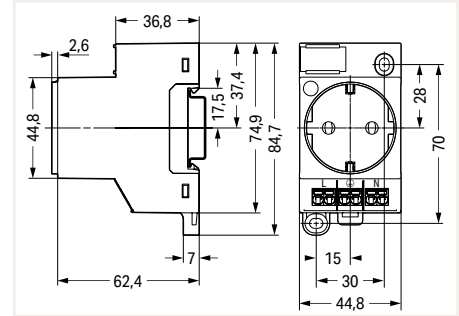

Control cabinet outlet; for DIN-35 rail and screw mounting; for plug Type F, CEE 7/4 (SCHUKO®); used in Germany, the Netherlands, Austria; with status LED; with Push-in CAGE CLAMP® double connection

Color	Item No.	Pack. Unit
● red	709-583 1	1



Dimensions in mm

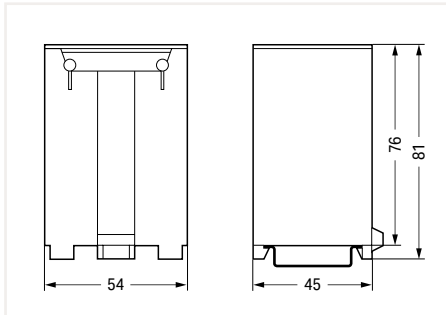

Switchgear cabinet drawer; DIN-35 rail-mount drawer

Item No.	Pack. Unit
709-591	1

DIN-Rail; Rail End Cap; Angled Support Bracket and Collective Jumper Carrier



Dimensions in mm

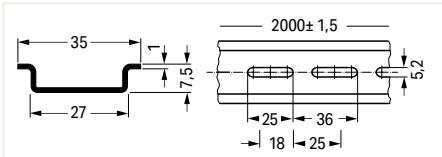

Steel DIN-rail; I_N 76 A (based on 1 m length); 35 x 7.5 mm; 1 mm thick; 2 m long; per EN 60715

	Item No.	Pack. Unit
unslotted	210-113	10 (1)

Hole width: 25 mm; Hole spacing: 36 mm

slotted	210-112	10 (1)
---------	---------	--------

Hole width: 18 mm; Hole spacing: 25 mm

slotted	210-115	1
---------	---------	---



Dimensions in mm

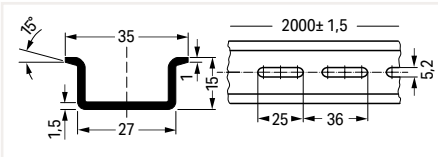

Steel DIN-rail; I_N 125 A (based on 1 m length); 35 x 15 mm; 1.5 mm thick; 2 m long; similar to EN 60715

	Item No.	Pack. Unit
unslotted	210-114	10 (1)
slotted	210-197	10 (1)



Dimensions in mm

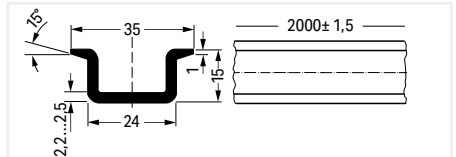

Steel DIN-rail; I_N 125 A (based on 1 m length); 35 x 15 mm; 2.3 mm thick; 2 m long; per EN 60715

	Item No.	Pack. Unit
unslotted	210-118	10 (1)



Dimensions in mm

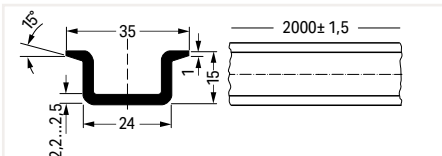

Copper DIN-rail; I_N 309 A (based on 1 m length); 35 x 15 mm; 2.3 mm thick; 2 m long; per EN 60715

	Item No.	Pack. Unit
unslotted	210-198	10 (1)



Dimensions in mm

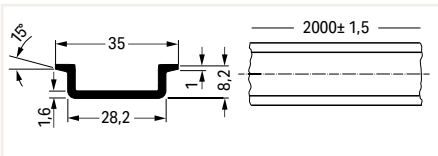

Aluminum DIN-rail; I_N 76 A (based on 1 m length); 35 x 8.2 mm; 1.6 mm thick; 2 m long; similar to EN 60715

	Item No.	Pack. Unit
unslotted	210-196	20 (1)



Rail end cap; for DIN-35 rail (7.5 mm high)

Color	Item No.	Pack. Unit
○ gray	209-109	50 (25)

14



Dimensions in mm

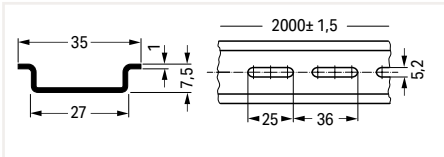

Steel DIN-rail; I_n 76 A (based on 1 m length); 35 x 7.5 mm; 1 mm thick; 2 m long; per EN 60715

	Item No.	Pack. Unit
unslotted	210-505	1
slotted	210-504	1



Dimensions in mm

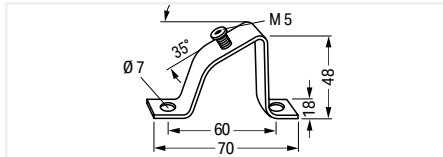

Angled support bracket; without screw

	Item No.	Pack. Unit
	210-148	10

Screw M5 x 8		
	210-149	100 (20)

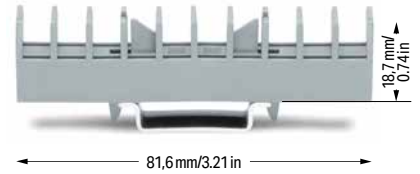

Collective jumper carrier; for DIN-35 rail; compatible with jumpers for transverse switching terminal block (282-811) and longitudinal switching disconnect terminal block (282-821)
The collective carrier can be snapped onto DIN-35 rails. It stores jumpers during maintenance.

Color	Item No.	Pack. Unit
○ gray	282-369	25



Dimensions in mm

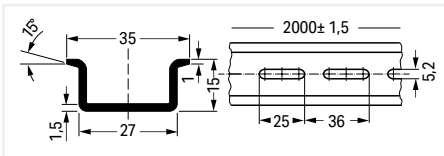

Steel DIN-rail; I_n 125 A (based on 1 m length); 35 x 15 mm; 1.5 mm thick; 2 m long; per EN 60715

	Item No.	Pack. Unit
unslotted	210-506	1
slotted	210-508	1



Dimensions in mm

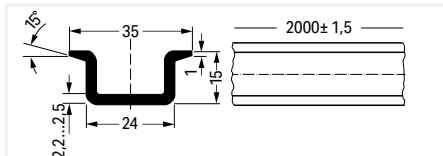

Carrier rail; plastic
Not suited for use with ground terminal blocks!

	Item No.	Pack. Unit
	210-509	10 (1)



Collective carrier for adjacent jumpers; for DIN-35 rail; for adjacent jumpers (279 to 284 Series); for banana plugs (215 Series)
The collective carrier can be snapped onto DIN-35 rails. It stores adjacent jumpers and banana plugs during maintenance.

Color	Item No.	Pack. Unit
○ gray	209-100	50 (25)

Screwless End Stop; for DIN-35 Rail 249 Series

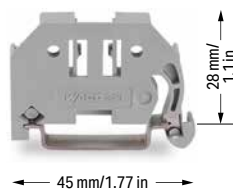

Screwless end stop; for DIN-35 rail; 6 mm wide

Color	Item No.	Pack. Unit
○ gray	249-116	100 (25)

Screwless end stop; for DIN-35 rail; 10 mm wide

○ gray	249-117	50 (25)
--------	---------	---------



Simply snap on – that's it!



Simply snap on – that's it!



Screwless end stop; for DIN-35 rail; 14 mm wide

Color	Item No.	Pack. Unit
○ gray	249-197	10



Simply snap on – that's it!



Removing an end stop from the DIN-rail.

Snap on – that's it! Assembling the WAGO Screwless End Stop is as simple and quick as snapping a rail-mount terminal block onto the rail.

Tool free!

A tool-free design allows rail-mount terminal blocks to be safely and economically secured against any movement on all DIN-35 rails per DIN EN 60715 (35 x 7.5 mm; 35 x 15 mm).

Screwless!

The "secret" to a perfect fit lies in the two small clamping plates which keep the end stop in position, even if the rails are mounted vertically.

Simply snap on – that's it!

In addition, costs are significantly reduced when using large numbers of end stops.

Additional benefit: Three marker slots for all WAGO Rail-Mount Terminal Block Marking Systems and one snap-in hole for WAGO's adjustable height group marker carriers offer individual marking options.

Mounting Foot



Mounting foot; for isolated DIN-35 rail mounting

Color	Item No.	Pack. Unit
<input type="radio"/> gray	209-106	25



Isolated mounting of a carrier rail in a distribution box for protection class II

Sealable, Transparent Covers for Rail-Mount Terminal Blocks

709 Series

Description and Installation

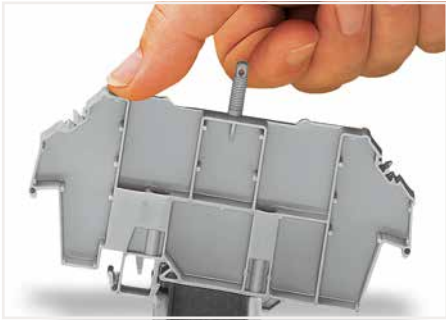

Snapping a cover carrier onto the DIN-rail.



Application example:
Cover (type 1) without safety warning



Application example:
Cover (type 1) with safety warning

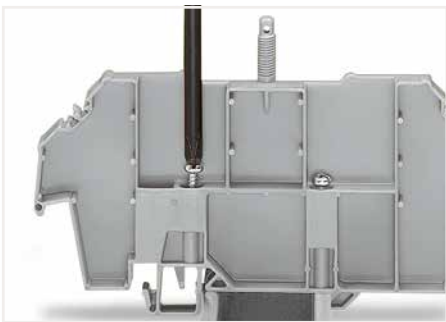

Tightening both securing screw (left) and mounting screw (right).



Application example:
Cover (type 2) with safety warning

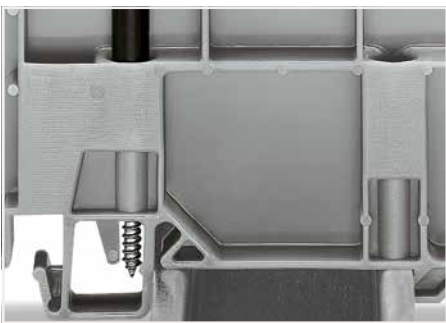

Securing screw – prevents lifting off from the rail.
Mounting screw – prevents the cover carrier from being moved on the rail.

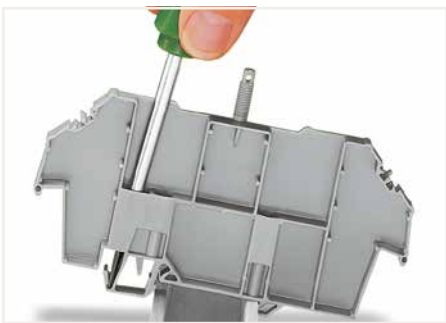

Removing a cover carrier from the DIN-rail.



Inserting a marking strip into the cover.



Cover with lead seals:
Using covers without lead seals,
the thread dome-head can be broken off.

Sealable, Transparent Cover; for Rail-Mount Terminal Blocks 709 Series



Cover; Type 1; for cover carrier (type 1); 1 m long		
Color	Item No.	Pack. Unit
transparent	709-153	10

Cover; Type 2; for cover carrier (type 2); 1 m long		
Color	Item No.	Pack. Unit
transparent	709-154	10

Accessories			
Marking card; with 6 marking strips; for group marking or safety instructions			
	plain	709-183	1

Spare mounting/securing screw; for cover		
		209-196 200 (25)

Spare knurled nut; for cover		
		210-549 100 (25)



Cover carrier; Type 1; incl. mounting/securing screws and knurled nut; for rail-mount terminal blocks (279 to 282, 880 Series); for "Mini" rail-mount terminal blocks (264 Series); for sensor/actuator terminal blocks (270 Series)

Cover carrier; Type 2; incl. mounting/securing screws and knurled nut; for rail-mount terminal blocks (283 to 285 Series); for double- and triple-deck terminal blocks (279 to 281 Series); for TOPJOB® rail-mount terminal blocks (780 to 785 and 775 Series); for sensor/actuator terminal blocks (280 Series); for disconnect/test terminal blocks for transformer circuits (282 Series)

Color	Item No.	Pack. Unit
○ gray	709-167	10

Color	Item No.	Pack. Unit
○ gray	709-168	10

Dimensions in mm

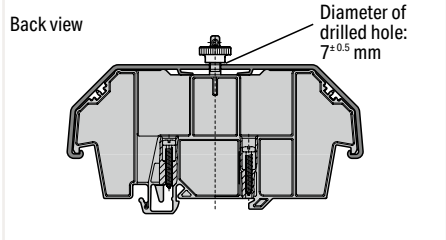
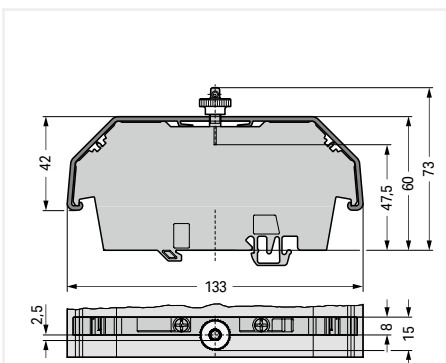

Dimensions in mm

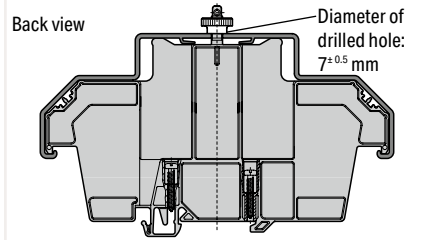
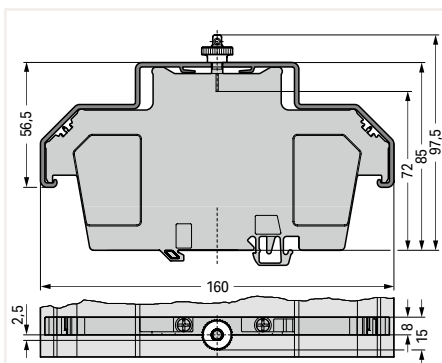



Sealable, Transparent Cover; for Rail-Mount Terminal Blocks 709 Series



Cover; Type 3; for cover carrier (type 3); 1 m long		
Color	Item No.	Pack. Unit
transparent	709-156	10

Accessories			
Marking card; with 6 marking strips; for group marking or safety instructions			
	plain	709-183	1

Marking strip; plain; 11 mm wide; 50 m reel			
	white	2009-110	1

Spare mounting/securing screw; for cover			
		209-196	200 (25)

Spare knurled nut; for cover			
		210-549	100 (25)



Cover carrier; Type 3; for rail-mount terminal blocks (2000 to 2016 Series, 2102 to 2116 Series, 2200 to 2216 Series); for transformer terminal blocks (2007 Series)		
Color	Item No.	Pack. Unit
○ gray	709-169	10

Dimensions in mm

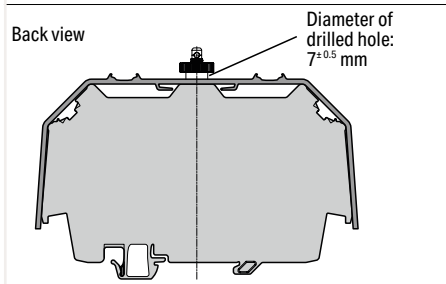
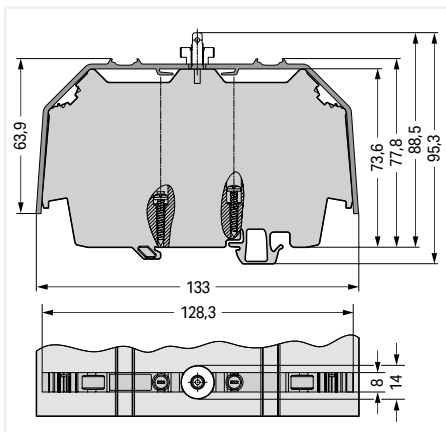

DIN-Rail and End Stop; for DIN-15 Rail



Dimensions in mm

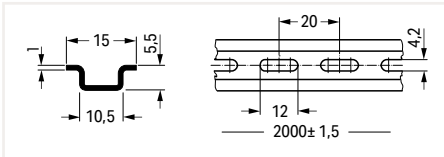

Steel DIN-rail; I_n 57 A (based on 1 m length); 15 x 5.5 mm; 1 mm thick; 2 m long; per EN 60715

	Item No.	Pack. Unit
slotted	210-111	10 (1)



Dimensions in mm

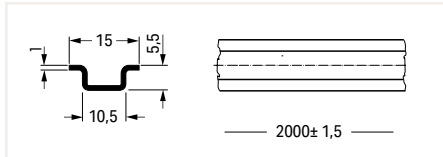

Aluminum DIN-rail; I_n 57 A (based on 1 m length); 15 x 5.5 mm; 1 mm thick; 2 m long; similar to EN 60715

	Item No.	Pack. Unit
unslotted	210-296	10 (1)



Screwless end stop; for DIN-15 rail; 6 mm wide; for WMB markers

Color	Item No.	Pack. Unit
○ gray	249-101	25



Dimensions in mm

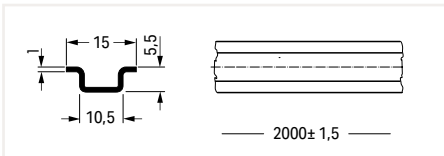

Steel DIN-rail; I_n 57 A (based on 1 m length); 15 x 5.5 mm; 1 mm thick; 2 m long; per EN 60715

	Item No.	Pack. Unit
unslotted	210-295	1

Operating Tool



Operating tool with a partially insulated shaft; Type 1, (2.5 x 0.4) mm blade

Item No.	Pack. Unit
210-719	50 (1)



Operating tool; Blades: 3.5 mm and 2.5 mm; for installation terminal blocks (TOPJOB® S)

Item No.	Pack. Unit
2009-309	50 (1)



Operating tool with a partially insulated shaft; Type 1; (2.5 x 0.4) mm blade; short

Item No.	Pack. Unit
210-647	50 (1)

Operating tool with a partially insulated shaft; Type 2, (3.5 x 0.5) mm blade

210-720	50 (1)
---------	--------

Operating tool; Blades: 3.5 mm and 5.5 mm; for installation terminal blocks (TOPJOB® S)

2009-310	50 (1)
----------	--------

Operating tool with a partially insulated shaft; (2.5 x 0.4) mm blade; short; angled

210-648	50 (1)
---------	--------

Operating tool with a partially insulated shaft; Type 3, (5.5 x 0.8) mm blade

210-721	25 (1)
---------	--------

Operating tool with a partially insulated shaft; (3.5 x 0.5) mm blade; short

210-657	50 (1)
---------	--------

Set of operating tools with a partially insulated shaft; Type 1, (2.5 x 0.4) mm blade; Type 2, (3.5 x 0.5) mm blade; Type 3, (5.5 x 0.8) mm blade

210-722	1
---------	---

Operating tool with a partially insulated shaft; (3.5 x 0.5) mm blade; short; angled

210-658	50 (1)
---------	--------

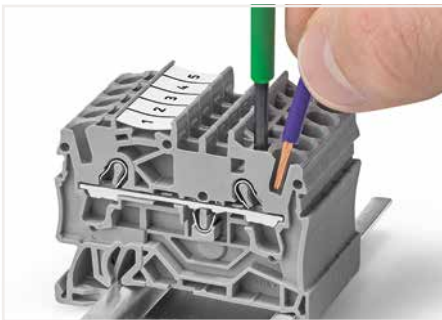

The blade of this operating tool with a partially insulated shaft is ideal for operating front-entry terminal blocks.



Open the clamping unit using an operating tool.

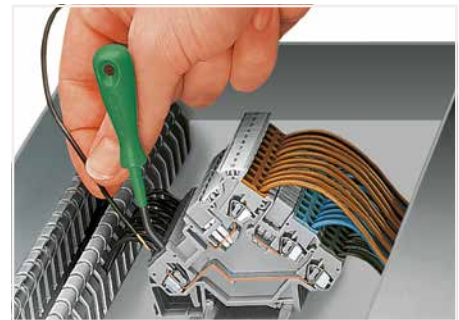

This operating tool with blade dimensions per DIN 5264 is ideal for front-entry sensor/actuator terminal blocks (280 Series).



Set of operating tools in a box (210-722)

Operating Tool



Operating tool; insulated; for 279 Series

	Item No.	Pack. Unit
1-way	209-129	100 (1)
2-way	279-432	100 (1)
3-way	279-433	100 (1)
10-way	279-440	30 (1)



Operating pliers; for side-entry rail-mount terminal blocks (281, 282, 283 and 284 Series)

	Item No.	Pack. Unit
	210-141	1



T-wrench with a partially insulated shaft

	Item No.	Pack. Unit
	285-172	1

Operating tool; insulated; for 264 Series (1- and 2-way only), 280, 281 Series (up to 3-way only)

	Item No.	Pack. Unit
1-way	209-130	100 (1)
2-way	280-432	100 (1)
3-way	280-433	100 (1)
4-way	280-434	40 (1)
5-way	280-435	40 (1)
6-way	280-436	30 (1)
7-way	280-437	30 (1)
8-way	280-438	30 (1)
9-way	280-439	30 (1)
10-way	280-440	30 (1)

Operating pliers; for side-entry rail-mount terminal blocks (279 and 280 Series)

	Item No.	Pack. Unit
	210-143	1

T-wrench with a partially insulated shaft and anti-rotation protection

	Item No.	Pack. Unit
	285-173	1

Operating tool; insulated; for 281 Series

	Item No.	Pack. Unit
5-way	281-440	40 (1)



Commoning front-entry disconnect terminal blocks via comb-style jumper bar using a 10-pole operating tool.

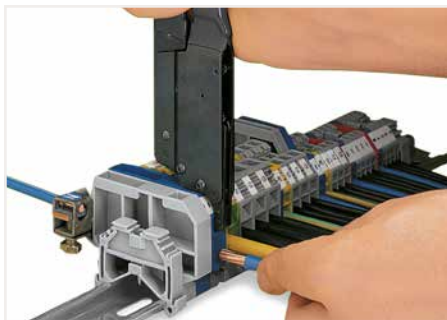

When operating the handles beyond the locked position, the ratchet allows the tool to open and be removed from the terminal block.
The operating pliers are placed into the upper operating slot of the rail-mount terminal block and the clamp is hooked into the lateral operating slot. The contact is fully opened by pressing the handles together until they engage. This will allow both hands to be used for wiring the terminal blocks.



T-wrench with a partially insulated shaft and anti-rotation protection (285-173)

Cable Stripper



Never use this tool on or near live electrical circuits!

Cable knife; for Ø 8 ... 28 mm / 0.31 ... 1.10 inch; with a unique, changeable cable bracket system; including cable bracket

Item No.	Pack. Unit
206-1403	1

Cable knife set; for Ø 4 ... 70 mm / 0.16 ... 2.75 inch; including all cable brackets in a Sortimo® Box

Item No.	Pack. Unit
206-1400	1



To replace the cable bracket, use the new bracket as an operating tool and pull it upwards.

Item-Specific Accessories

Cable bracket; for Ø 4 ... 16 mm / 0.16 ... 0.63 inch

	206-1411	1
--	----------	---

Cable bracket; for Ø 8 ... 28 mm / 0.31 ... 1.10 inch

	206-1412	1
--	----------	---

Cable bracket; for Ø 27 ... 35 mm / 1.06 ... 1.38 inch

	206-1413	1
--	----------	---

Cable bracket; for Ø 35 ... 50 mm / 1.38 ... 1.97 inch

	206-1414	1
--	----------	---

Cable bracket; for Ø 50 ... 70 mm / 1.97 ... 2.75 inch

	206-1415	1
--	----------	---

Accessories

Spare inside blade

	206-1418	1
--	----------	---

Spare hook blade

	206-1419	1
---	----------	---



The cutting depth of the hook blade can be adjusted with the slider.



The cutting depth of the inner knife can be adjusted with the screw.

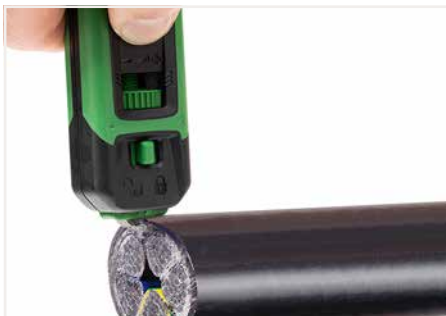

Strip large cross sections with the hook blade.



Release the fuse before using the hook blade.

Cable Stripper



In-socket cable stripper; for \varnothing 8 ... 13 mm / 5/16 ... 1/2 inch

Item No.	Pack. Unit
206-1441	1



Universal cable stripper; for \varnothing 8 ... 13 mm / 5/16 ... 1/2 inch

Item No.	Pack. Unit
206-1442	1



Data cable stripper; for \varnothing 4.5 ... 10 mm / 3/16 ... 3/8 inch

Item No.	Pack. Unit
206-1451	1



Product features:

- Extra long design and improved force transmission simplifies stripping in deep device connection sockets
- Special four-blade design for an even more precise round cut
- No cutting depth adjustment required
- TiN-coated blades, TÜV/GS tested
- \varnothing 8 ... 13 mm / 5/16 ... 1/2 inch
- Strips all standard round cables, including NYM 3 x 1.5 mm²/16 AWG ... 5 x 2.5 mm²/14 AWG



Sheath stripping: longitudinal cut

Product features:

- Secure grip achieved with soft padding for non-slip grips
- Technically improved functionality
- New locking mechanism prevents the unwanted opening of the tool
- Absolutely straightforward, quick and easy longitudinal cuts – with innovative internal cable duct
- Redesigned blade layout and intake to stop cable waste from jamming the tool
- Durable and ergonomically designed pocket clip
- \varnothing 8 ... 13 mm / 5/16 ... 1/2 inch



Product features:

- Strip outer insulation and foil sheathing with one tool
- Ideal for stripping PVC-insulated data cables with thin insulation (e.g., Cat. 5, Cat. 6, Cat. 7, twisted pair cable)
- TiN-coated blades
- \varnothing 4.5 ... 10 mm / 3/16 ... 3/8 inch



Stripping a cable sheath.



Built-in handy knife



Stripping a conductor insulation.

Cable Stripper



Never use this tool on or near live electrical circuits!

The stripping pliers for sensor cables have a blade geometry specially designed for sensor cables with a smaller cross section and a working range from Ø 3.2 mm / 0.13 inch (for stranded cables and round cables with Ø 3.2 mm ... 4.4 mm / 0.13 ... 0.17 inch).

The stripping pliers for control cables are designed for stronger cables from Ø 4.4 mm / 0.17 inch (for stranded cables and round cables with Ø 4.4 mm ... 7 mm / 0.17 ... 0.27 inch).

These stripping pliers quickly and safely strip cables for connecting, e.g., sensor/actuator distribution boxes, bus couplers and pluggable connectors.

Suitable for:

- Halogen-free PUR sensor/actuator cables
- Highly flexible TPE-U cables
- Control cables
- PUR cables
- PUR/PVC cables
- PVC cables
- Multi-core cables
- Shielded and unshielded cables

Stripping pliers; for sensor cables; for Ø 3.2 ... 4.4 mm / 0.13 ... 0.17 inch

Item No.	Pack. Unit
206-1481	1

Stripping pliers; for control cables; for Ø 4.4 ... 7 mm / 0.17 ... 0.27 inch

Item No.	Pack. Unit
206-1482	1

Item-Specific Accessories

Replacement blade set; for Ø 3.2 ... 4.4 mm / 0.13 ... 0.17 inch

206-1491	1
----------	---



Item-Specific Accessories

Replacement blade set; for Ø 4.4 ... 7 mm / 0.17 ... 0.27 inch

206-1492	1
----------	---



Wire Stripper



Wire stripper "Quickstrip Vario"; 0.03 ... 16 mm² / 34 ... 6 AWG; with wire cutter

Item No.	Pack. Unit
206-1125	1

Accessories

Blade set; Standard; 0.03 ... 16 mm² / 34 ... 6 AWG

206-1126 1



Blade set; V-blade; 0.14 ... 4 mm² / 24 ... 12 AWG

206-1127 1



Blade set; Oval blade; 10 ... 16 mm² / 8 ... 6 AWG

206-1128 1



Spare stripping stop

206-1129 1



Spare cut protector

206-1131 1



Spare clamping jaws

206-1132 1

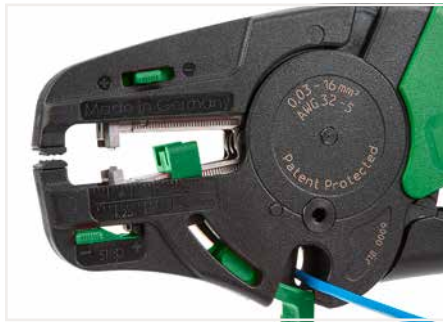

Cutting a conductor.



Partially stripping a conductor.

Wire Stripper:

- Automatically adjust to conductor size
- Stripping blades cause no damage to conductor strands
- Gripping pressure of jaws adjusts automatically to conductor insulation diameter
- Clamping jaws and stripping blades automatically open once the stripping process is completed – no splaying of the conductor strands
- Exact strip length may be set by sliding black setting stop
- Stripping blades can be replaced
- Self-sharpening, fully protected cutter (replaceable)
- Entire body made of glass-fiber-reinforced polyamide
- Cutting capacity of the wire cutter of fine-stranded conductors up to 16 mm² (6 AWG)

Crimping Tool



Crimping tool "Variocrimp 4"; for insulated and uninsulated ferrules; Crimping range: 0.25 ... 4 mm² (24 ... 12 AWG)

Item No.	Pack. Unit
206-1204	1

Crimping tool "Variocrimp 16"; for insulated and uninsulated ferrules; Crimping range: 6 mm² (10 AWG), 10 mm² (8 AWG) and 16 mm² (6 AWG)

Item No.	Pack. Unit
206-1216	1

Item-Specific Accessories

Spring clamp; large

	206-1205	1
--	----------	---

Spring clamp; small

	206-1206	1
---	----------	---

Item-Specific Accessories

Spring clamp; small

	206-1206	1
---	----------	---

Application notes:

- The built-in crimping pressure control of "Variocrimp 4" automatically adjusts the crimping force to the conductor cross section. Select the wire gauge on "Variocrimp 16" before crimping.
- Only one crimping station is needed to handle the specified conductor range.
- Uniform, compact crimping on all four sides for high conductor retention.
- No need to center the ferrules into the terminal blocks.
- Crimping can be performed from either side (for left- or right-handed users).
- Built-in ratchet mechanism ensures gas-tight crimp connection.
- Crimping tools open automatically after crimping operation is complete.
- Ergonomically designed handles.



Insert the ferruled conductor into the crimping station.



Squeeze handles until ratchet mechanism is released.

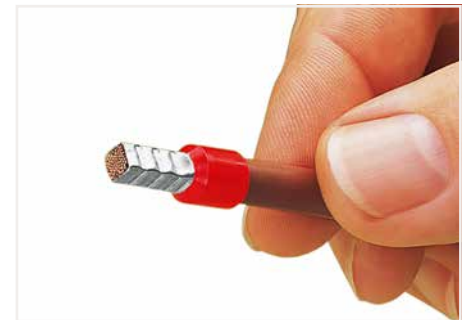

A perfect gas-tight crimp – both electrically and mechanically reliable



Only for "Variocrimp 16":
Adjust conductor cross section with crimping tool in open position.

Insulated ferrule; for Rail-Mount Terminal Block TOPJOB® S

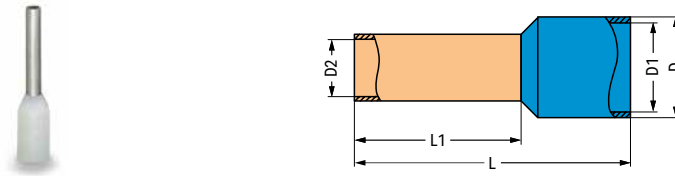

Ferrule; insulated; electro-tin-plated; electrolytic copper; gastight crimped; per DIN 46288 (Part 4/09.09)

Conductor Cross Section	Color	Strip Length	L	L 1	D	D 1	D 2	Item No.	Pack. Unit
0.5 mm ² / 20 AWG	○ white	12 mm / 0.47 inch	16	10	3,1	2,6	1	216-241	1000
0.75 mm ² / 18 AWG	○ gray	12 mm / 0.47 inch	16	10	3,3	2,8	1,2	216-242	1000
0.75 mm ² / 18 AWG	○ gray	14 mm / 0.55 inch	18	12	3,3	2,8	1,2	216-262	1000
1 mm ² / 18 AWG	● red	12 mm / 0.47 inch	16	10	3,5	3	1,4	216-243	1000
1 mm ² / 18 AWG	● red	14 mm / 0.55 inch	18	12	3,5	3	1,4	216-263	1000
1.5 mm ² / 16 AWG	● black	12 mm / 0.47 inch	16	10	4	3,5	1,7	216-244	1000
1.5 mm ² / 16 AWG	● black	14 mm / 0.55 inch	18	12	4	3,5	1,7	216-264	1000
1.5 mm ² / 16 AWG	● black	20 mm / 0.79 inch	24	18	4	3,5	1,7	216-284	500
2.5 mm ² / 14 AWG	● blue	12 mm / 0.47 inch	17	10	4,7	4,2	2,2	216-246	1000
2.5 mm ² / 14 AWG	● blue	14 mm / 0.55 inch	19	12	4,7	4,2	2,2	216-266	1000
2.5 mm ² / 14 AWG	● blue	20 mm / 0.79 inch	25	18	4,7	4,2	2,2	216-286	500
4 mm ² / 12 AWG	○ gray	14 mm / 0.55 inch	20	12	5,4	4,8	2,8	216-267	500
4 mm ² / 12 AWG	○ gray	20 mm / 0.79 inch	26	18	5,4	4,8	2,8	216-287	100
6 mm ² / 10 AWG	● yellow	14 mm / 0.55 inch	20	12	6,9	6,3	3,5	216-208	100
6 mm ² / 10 AWG	● yellow	20 mm / 0.79 inch	26	18	6,9	6,3	3,5	216-288	100
10 mm ² / 8 AWG	● red	20 mm / 0.79 inch	28	18	8,4	7,6	4,5	216-289	100
16 mm ² / 6 AWG	● blue	23 mm / 0.91 inch	28	18	9,6	8,8	5,8	216-210	100



Fine-stranded conductors with ferrules from at least two sizes below the rated cross section up to the rated cross section can also be simply pushed in – without tools.

Insulated and Uninsulated Ferrules; for Chassis-Mount Terminal Strip

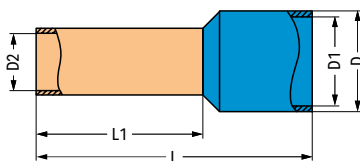

Ferrule; insulated; electro-tin-plated; electrolytic copper; gastight crimped; per DIN 46288 (Part 4/09.09)

Conductor Cross Section	Color	Strip Length	L	L 1	D	D 1	D 2	Item No.	Pack. Unit
0.5 mm ² / 20 AWG	○ white	12 mm / 0.47 inch	16	10	3,1	2,6	1	216-241	1000
0.75 mm ² / 18 AWG	○ gray	12 mm / 0.47 inch	16	10	3,3	2,8	1,2	216-242	1000
1 mm ² / 18 AWG	● red	12 mm / 0.47 inch	16	10	3,5	3	1,4	216-243	1000
1.5 mm ² / 16 AWG	● black	12 mm / 0.47 inch	16	10	4	3,5	1,7	216-244	1000

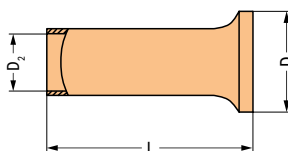

Ferrule; uninsulated; electro-tin-plated; electrolytic copper; gastight crimped; per DIN 46288 (Part 4/09.09)

Conductor Cross Section	Strip Length	L	D	D 2	Item No.	Pack. Unit
0.5 mm ² / 20 AWG	10 mm / 0.39 inch	10	2,1	1	216-141	5000 (1000)
0.75 mm ² / 18 AWG	10 mm / 0.39 inch	10	2,3	1,2	216-142	5000 (1000)
1 mm ² / 18 AWG	10 mm / 0.39 inch	10	2,5	1,4	216-143	5000 (1000)
1.5 mm ² / 16 AWG	10 mm / 0.39 inch	10	2,8	1,7	216-144	5000 (1000)

Insulated and Uninsulated Ferrules

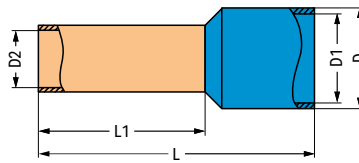

Ferrule; insulated; electro-tin-plated; electrolytic copper; gastight crimped; per DIN 46288 (Part 4/09.09)

Conductor Cross Section	Color	Strip Length	L	L 1	D	D 1	D 2	Item No.	Pack. Unit
0.25 mm ² / 24 AWG	● yellow	7 mm / 0.28 inch	10	6	2,3	1,8	0,85	216-321	1000
0.25 mm ² / 24 AWG	● yellow	9 mm / 0.35 inch	12	8	2,3	1,8	0,85	216-301	1000
0.34 mm ² / 22 AWG	● green	7 mm / 0.28 inch	10	6	2,5	2	0,85	216-322	1000
0.34 mm ² / 22 AWG	● green	9 mm / 0.35 inch	12	8	2,5	2	0,85	216-302	1000
0.5 mm ² / 20 AWG	○ white	7 mm / 0.28 inch	12	6	3,1	2,6	1	216-221	1000
0.5 mm ² / 20 AWG	○ white	9 mm / 0.35 inch	14	8	3,1	2,6	1	216-201	1000
0.75 mm ² / 18 AWG	○ gray	8 mm / 0.31 inch	12	6	3,3	2,8	1,2	216-222	1000
0.75 mm ² / 18 AWG	○ gray	10 mm / 0.39 inch	14	8	3,3	2,8	1,2	216-202	1000
1 mm ² / 18 AWG	● red	8 mm / 0.31 inch	12	6	3,5	3	1,4	216-223	1000
1 mm ² / 18 AWG	● red	10 mm / 0.39 inch	14	8	3,5	3	1,4	216-203	1000
1.5 mm ² / 16 AWG	● black	8 mm / 0.31 inch	12	6	4	3,5	1,7	216-224	1000
1.5 mm ² / 16 AWG	● black	10 mm / 0.39 inch	14	8	4	3,5	1,7	216-204	1000
2.08 mm ² / 14 AWG	● yellow	10 mm / 0.39 inch	15	8	4,8	4,2	2,05	216-205	1000
2.5 mm ² / 14 AWG	● blue	10 mm / 0.39 inch	15	8	4,7	4,2	2,2	216-206	1000
4 mm ² / 12 AWG	○ gray	12 mm / 0.47 inch	18	10	5,4	4,8	2,8	216-207	500
6 mm ² / 10 AWG	● yellow	14 mm / 0.55 inch	20	12	6,9	6,3	3,5	216-208	100
10 mm ² / 8 AWG	● red	16 mm / 0.63 inch	22	12	8,4	7,6	4,6	216-209	100
16 mm ² / 6 AWG	● blue	23 mm / 0.91 inch	28	18	9,6	8,8	5,8	216-210	100

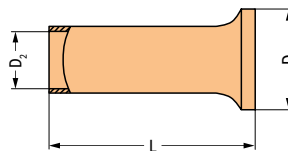

Ferrule; un-insulated; electro-tin-plated; electrolytic copper; gastight crimped; per DIN 46288 (Part 4/09.09)

Conductor Cross Section	Strip Length	L	D	D 2	Item No.	Pack. Unit
0.25 mm ² / 24 AWG	5 mm / 0.2 inch	5	1,7	0,75	216-151	1000
0.25 mm ² / 24 AWG	7 mm / 0.28 inch	7	1,7	0,75	216-131	1000
0.34 mm ² / 22 AWG	5 mm / 0.2 inch	5	1,8	0,85	216-152	1000
0.34 mm ² / 22 AWG	7 mm / 0.28 inch	7	1,8	0,85	216-132	1000
0.5 mm ² / 20 AWG	6 mm / 0.24 inch	6	2,1	1	216-121	1000
0.5 mm ² / 20 AWG	8 mm / 0.31 inch	8	2,1	1	216-101	1000
0.75 mm ² / 18 AWG	6 mm / 0.24 inch	6	2,3	1,2	216-122	1000
0.75 mm ² / 18 AWG	8 mm / 0.31 inch	8	2,3	1,2	216-102	1000
1 mm ² / 18 AWG	6 mm / 0.24 inch	6	2,5	1,4	216-123	1000
1 mm ² / 18 AWG	8 mm / 0.31 inch	8	2,5	1,4	216-103	1000
1.5 mm ² / 16 AWG	6 mm / 0.24 inch	6	2,8	1,7	216-124	1000
1.5 mm ² / 16 AWG	8 mm / 0.31 inch	8	2,8	1,7	216-104	1000
2.5 mm ² / 14 AWG	10 mm / 0.39 inch	10	3,4	2,2	216-106	1000
4 mm ² / 12 AWG	10 mm / 0.39 inch	10	4	2,8	216-107	1000
6 mm ² / 10 AWG	12 mm / 0.47 inch	12	4,7	3,5	216-108	500
10 mm ² / 8 AWG	12 mm / 0.47 inch	12	5,8	4,5	216-109	500
16 mm ² / 6 AWG	15 mm / 0.59 inch	15	7,5	5,8	216-110	500

Crimping Tool



Crimping tool 25; for insulated and uninsulated ferrules; crimping range: 10 mm² (8 AWG), 16 mm² (6 AWG) and 25 mm² (4 AWG)

Item No.	Pack. Unit
206-1225	1

Crimping tool 50; for insulated and uninsulated ferrules; crimping range: 35 mm² (2 AWG) and 50 mm² (1/0 AWG)

Item No.	Pack. Unit
206-1250	1



Insert the ferruled conductor into the crimping station.



Squeeze handles until ratchet mechanism is released.

Application notes:

- Improved crimping for higher conductor retention
- Crimping can be performed from either side (for left- or right-handed users).
- Built-in ratchet mechanism ensures gas-tight crimp connection.
- Crimping tools open automatically after crimping operation is complete.
- Ergonomically designed handles.

What is a "gas-tight" connection?

In a gas-tight connection, the conductor and the ferrule are compressed, eliminating all spaces. Under normal atmospheric conditions, neither a liquid nor gaseous medium can penetrate the crimped connection.

Oxidation between crimped single conductors is prevented, virtually eliminating the possibility of any increase in the crimped connection's resistance. In some exceptional cases, minute, isolated spaces may be present. However, these instances can be considered as closed off due to the twisted conductor.

Inadequate crimping can allow the conductor to be pulled out of the connection. Hollow spaces also remain, permitting oxidation formation and an increase in contact resistance.

Elevated resistance is detrimental for both signal transmission (signal flow is damped) and power transmission, resulting in power loss and contact heating (risk of fire). Crimping tools with built-in ratchets are recommended (e.g., WAGO Crimping Tools). These tools open automatically after the crimping operation is complete. Space-saving crimping from all four sides is ideal for spring clamp termination.

Ferruled conductor cross sections specified for WAGO products are based on this crimping method.

Uninsulated Ferrule

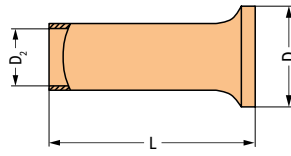

Ferrule; uninsulated; electro-tin-plated; electrolytic copper; gastight crimped; per DIN 46288 (Part 4/09.09)

Conductor Cross Section	Strip Length	L	D	D 2	Item No.	Pack. Unit
25 mm ² / 4 AWG	25 mm / 0.98 inch	25	9,5	7,3	216-413	50
35 mm ² / 2 AWG	25 mm / 0.98 inch	25	11	8,3	216-414	50
35 mm ² / 2 AWG	30 mm / 1.18 inch	30	11	8,3	216-424	50
50 mm ² / 1/0 AWG	30 mm / 1.18 inch	30	13	10,3	216-425	50
50 mm ² / 1/0 AWG	35 mm / 1.38 inch	35	13	10,3	216-435	50

Cable Cutter



Cable cutter; for copper and aluminum cables up to 35 mm² (2 AWG)

Item No.	Pack. Unit
206-118	10 (1)



Cutting a cable.

"Alu-Plus" Contact Paste Terminating Aluminum Conductors



Syringe; contains 20 ml "Alu-Plus" Contact Paste

Item No.	Pack. Unit
249-130	20 (5)



WAGO Lighting Connectors

Push nozzle of the "Alu-Plus" syringe first into the circular entry and then into the square conductor entry hole of the WAGO Lighting Connector.



Press plunger down until the "Alu-Plus" has filled both entry holes.

Note: Not suitable for higher temperature applications!

Terminating Aluminum Conductors

WAGO spring clamp terminal blocks are suitable for solid aluminum conductors ① up to 4 mm²/12 AWG if WAGO "Alu-Plus" Contact Paste is used for termination.

Advantages of the "Alu-Plus" Contact Paste:

- Automatically destroys the oxide film during clamping.
- Prevents fresh oxidation at the clamping point.
- Prevents electrolytic corrosion between aluminum and copper conductors (in the same terminal block).
- Provides long-term protection against corrosion.



WAGO Rail-Mount Terminal Blocks (up to 4 mm²/12 AWG)

For each conductor entry: Insert nozzle of the "Alu-Plus" syringe in every open conductor entry hole (one after the other).



Press plunger down until "Alu-Plus" has filled all conductor entry holes.

Using terminal blocks with CAGE CLAMP® Spring Pressure Connection Technology, aluminum conductors must first be cleaned with a blade and then immediately be inserted into the clamping units filled with "Alu-Plus" Contact Paste.

It is also possible to apply WAGO "Alu-Plus" additionally on the whole surface of the aluminum conductor before termination.

Please note that the nominal currents must be adapted to the reduced conductivity of the aluminum conductors:

$$\begin{aligned} 2.5 \text{ mm}^2 \text{ (14 AWG)} &= 16 \text{ A} \\ 4 \text{ mm}^2 \text{ (12 AWG)} &= 22 \text{ A} \end{aligned}$$

WAGO "Alu-Plus" in the syringe offers a higher degree of reliability and cleanliness when terminating solid aluminum conductors. Filling is quickly performed on selected WAGO connectors and terminal blocks (see pictures).

① Aluminum conductors per IEC 61545 standard, Class B, "Alloy 1370" with 90 ... 180 N/mm² tensile strength and 1 ... 4% elongation
Standard values: 90 ... 180 MPa tensile strength, 1 ... 4% elongation (per EN 615.4.1)

Test and Measurement Devices

206 Series



Testboy; with integrated flashlight, non-contact voltage tester

	Item No.	Pack. Unit
	206-804	6 (1)



A device that will reliably detect AC voltage in cables, sockets, fuses, switches, outlets and other installations. Testboy can detect the following:

- Live conductors
- Cable breaks
- Blown fuses (in cartridges or holders)
- Defective switches
- Defective lamps in strings of lights

Test and Measurement Devices

206 Series



Profi-LCD+; 2-pole voltage tester with LCD display; removable 4 mm Ø test probes

Item No.	Pack. Unit
206-707	1



Profi-LED+; 2-pole voltage tester with LED display; removable 4 mm Ø test probes

Item No.	Pack. Unit
206-706	1



Spare test probes; 4 mm Ø (2 pieces)

Item No.	Pack. Unit
206-808	1



Additional Profi-LCD+ features:

- Automatic measurement range selection
- Single-pole phase testing AC > 100 V
- Two-pole sequence testing (R and L)
- Continuity testing
- RDC/RCD testing (30 mA) via buttons
- One-hand operation for SCHUKO® and CEE sockets
- LED torch lamp function
- Automatic backlight
- Auto power-off function
- CAT IV 1000 V
- TÜV/GS tested and approved
- IEC/EN 61243-3 (DIN VDE 0682-401)



Additional Profi-LED+ features:

- Automatic measurement range selection
- Single-pole phase testing AC > 100 V
- Two-pole sequence testing (R and L)
- Continuity testing
- RDC/RCD testing (30 mA) via buttons
- One-hand operation for SCHUKO® and CEE sockets
- LED torch lamp function
- CAT IV 1000 V
- TÜV/GS tested and approved
- IEC/EN 61243-3 (DIN VDE 0682-401)

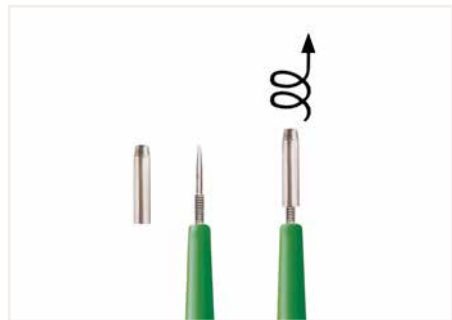

Profi-LED+:

- Improved socket contact via 4 mm Ø test probes
- Removable test probes for small test ports (suitable for all WAGO Terminal Blocks)



Banana Plug (Only for Safety Extra-Low Voltage) 215 Series

Technical Data

0.08 ... 2.5 mm ²	28 ... 14 AWG
max. 42 V	
Test current: 20 A	
Measuring range category: CAT I	
9 ... 11 mm / 0.35 ... 0.43 inch	



Conductor termination: Press button fully, insert stripped conductor into square entry and release.



Testing via banana plug. Picture shows a test plug adapter (209-170).

Banana plug; for 4 mm socket diameter; color mixed; 10 x orange, white, black, blue, yellow

	Item No.	Pack. Unit
	215-111	50

Banana plug; single

Banana plug; for 4 mm socket diameter

	orange	215-211	50
--	--------	---------	----

Banana plug; for 4 mm socket diameter

	red	215-212	50
---	-----	---------	----

Banana plug; for 4 mm socket diameter

	black	215-311	50
---	-------	---------	----

Banana plug; for 4 mm socket diameter

	green	215-411	50
---	-------	---------	----

Banana plug; for 4 mm socket diameter

	yellow	215-511	50
---	--------	---------	----

Banana plug; for 4 mm socket diameter

	white	215-611	50
---	-------	---------	----

Banana plug; for 4 mm socket diameter

	blue	215-711	50
---	------	---------	----

Banana plug; for 4 mm socket diameter

	gray	215-811	50
---	------	---------	----

Banana plug; for 4 mm socket diameter

	green-yellow	215-911	50
---	--------------	---------	----

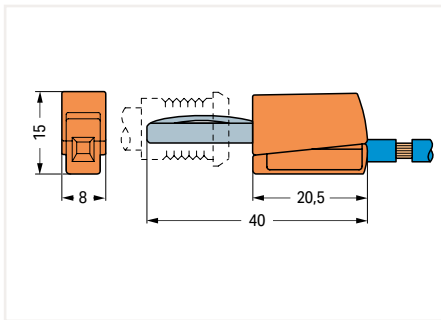

Dimensions in mm

Test Plug 210 Series



Test plug; with 500 mm cable; 2 mm Ø; max. 42 V

Color	Item No.	Pack. Unit
● red	210-136	50 (1)

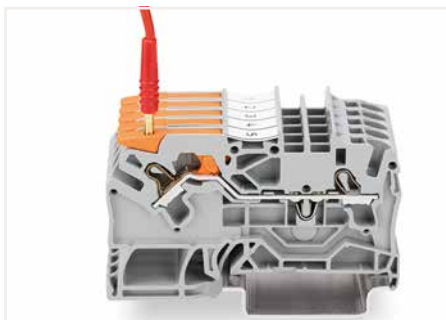







Testing with a 2 mm Ø test plug (max. 42 V).

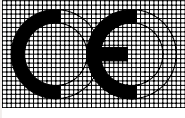

Technical Section

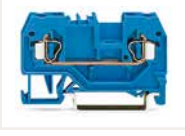
Technical Section

	Page
	684
Technical information CE Marking and EC Directives	
Tests and testing procedures Mechanical, Electrical, Material and Environmental Tests	686
UL Specifications – Underwriters Laboratories, USA Tests and Testing Procedures per UL Standards	706
	711
“Alu-Plus” Contact Paste Terminating aluminum conductors	
Material Specifications Insulation Materials, Contact Plating, Contact Materials and Clamping Spring Material	714
	716
General Technical Information on Electrical Equipment Used in Hazardous Areas	
	716
All terminal blocks used in hazardous areas “Ex e II” have their item numbers marked with the Ex symbol.	
	716
All terminal blocks used in intrinsically safe current circuits “Ex i” have their item numbers marked with a blue circle.	
International Certification Organizations – Overview	726
	728
Electrical Engineering Laboratory Product Safety for Our Customers	
	730
WAGO Seminars Learn Today – Benefit Tomorrow Benefit from First-Hand Knowledge and Expertise – Training Straight from the Source!	

CE Marking and EC Directives

CE Conformity Marking

The CE conformity marking consists of the characters "CE" with the following script:

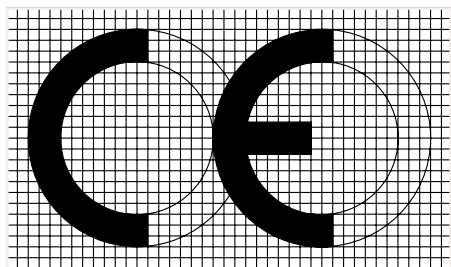

Communauté Européenne
(European Community)

WAGO Kontakttechnik GmbH & Co. KG products are developed, tested and marked in accordance with legally valid international standards and laws.

The CE mark is applied to products intended for the European domestic market; with it, manufacturers declare that the marked electrical equipment conforms with the applicable requirements set out in the Community harmonization legislation (EU Directives), which allows such equipment to carry this mark.

The original intention of this mark was to support the authorities in the EU member states in their market supervision, with the mark acting as a symbol of free movement of products within the EU. According to EC Directive 765/2008, a product can only be given the CE mark if the product requirements are defined in at least one appropriate EU directive. Examples of such directives are the Low Voltage Directive, the EMC Directive, the ATEX Directive, the Building Products Directive and the Machinery Directive. If more than one directive applies to a product, the product must comply with all applicable directives.

Only the basic requirements for achieving the defined aim of the directive are laid out in each respective directive. The individual technical details are specified according to the New Approach using lists with cross references to applicable standards (so-called harmonized standards).

1. Low Voltage Directive (LVD)

The safety of electrical equipment is guaranteed by the Low Voltage Directive (LVD). The LVD covers all electrical equipment operating with a voltage between 50 VAC and 1000 VAC and between 75 VDC and 1500 VDC.

Products falling within the scope of the Low Voltage Directive that are designed in such a way that they can be used in other electrical devices, and whose safety, for the most part, is dependant on how these components were built into the end product and what features the end product has, are defined as basic components in accordance with the Low Voltage Directive.

The LVD doesn't apply to basic components.

The RoHS Directive also applies to electrical equipment covered by the Low Voltage Directive. This

directive regulates the use of hazardous substances in electrical devices and components, with the aim of reducing the quantity of problematic components in electrical waste. Details about the materials used by WAGO are available in our catalogs, on our product packaging and on our Web page.

2. EMC Directive

The EMC Directive stipulates that a product must meet the limits on radiated electromagnetic disturbance and also requires that a product must be immune to electromagnetic interference.

Electromagnetic passive components or components with no direct function, such as terminal blocks, resistors, diodes, capacitors, switching relays or cables (in the form of passive printed circuit boards) are not considered as apparatus within the meaning of the EMC Directive.

3. ATEX Directive on Explosion Protection

The ATEX Directive defines the rules for products (devices and protective systems) intended for use in hazardous locations. A number of products from WAGO are designed for use in hazardous areas.

Based on potential hazards, the ATEX Directive makes a distinction between three different equipment groups, of which Group II and III are subdivided into further zones. Suitability of WAGO products for the different groups and zones is outlined in the specific product documents (catalogs, Internet site, data sheets and product inserts).

These may be either devices that can be used as equipment in these types of areas, or components that are required for safe operation, but which do not fulfill a dedicated function. Such components include rail-mount terminal blocks for use in hazardous areas.

Products in both groups must comply with the ATEX Directive.

4. Radio Communications Directive

The Radio Communications Directive applies to all devices that properly transmit or receive radio waves for wireless communications and/or radio orientation. The basic safety requirements apply to the protection of health for humans and animals and to electrical safety in line with the Low Voltage Directive, but without the application of the voltage limit. In addition, the EMC protection goals of the EMC Directive must also be fulfilled and efficient use of radio frequencies ensured. WAGO products covered by the Radio Communications Directive indicate, in compliance with applicable laws, only the Radio Communication Directive in their EU Declaration of Conformity, as fulfillment of the Low Voltage Directive and of the EMC Directive is implicit in this declaration.

5. Construction Products Regulation

The Construction Products Regulation demands that structures be designed and constructed such that the safety of humans, property and animals is not endangered and that all applicable environmental protection requirements be considered. Here, building products are defined as products or

construction sets which are produced to be built permanently into structures and which make a significant contribution to fulfilling the basic requirements for the structure.

In the unanimous opinion expressed by the German electrical industry, including WAGO Kontakttechnik GmbH & Co. KG, products used in general installation technology are not included among these types of building products and are therefore not covered by this directive.

6. Machinery Directive

The Machinery Directive applies to machines (complete or incomplete) which perform their functions by means other than direct human or animal work, or safety components for these types of machines.

Therefore, this directive usually does not apply to WAGO products.

The manufacturers of machines or systems are required by this directive to use safe products and components in their machines and systems. Directive-compliant production and safe operation is facilitated by the use of WAGO products, with their standard-compliant, up-to-date design.

Significance of CE Mark for WAGO Products

One, several or none of the EU Directives may apply to the various WAGO products. If none of the directives apply, the CE marking will not be affixed to the product, in line with applicable laws. Furthermore, a declaration of conformity must not be issued. All other products are provided with the CE mark – either directly on the product, on its packaging or in the documents included with the product – and a declaration of conformity is issued, or made accessible to the customer.

The data sheets of the technically sound products that, according to the regulations, are not CE marked will refer to the standards used in the development and type and manufacturing testing wherever possible.

IEC/EN specifications

The following standards apply to the design and application of the terminal blocks and connectors contained in this catalog:

IEC 60364-1 HD 60364-1 VDE 0100-100 / Erection of power installations with nominal voltages up to 1000 V – Part 1: Fundamental principles, assessment of general characteristics, definitions	EN 50628 VDE 0118-10 / Installation of electrical equipment in mines	IEC 60999-2 EN 60999-2 VDE 0609-101 /– Part 2: General requirements and particular requirements for clamping units for conductors from 35 mm ² up to 300 mm ² (included)
IEC 60364-7-710 HD 60364-7-710 VDE 0100-710 /– Part 7-718: Requirements for special installations or locations – Medical areas	IEC 60038 EN 60038 VDE 0175-1 / IEC CENELEC standard voltages	IEC 60998-1 EN 60998-1 VDE 0613-1 / Connecting devices for low-voltage circuits for household and similar purposes – Part 1: General requirements
IEC 60364-7-718 HC 60364-7-718 VDE 0100-718 /– Part 7-718: Requirements for special installations or locations – Communal facilities and workplaces	VDE 0298-4 / Use of cables and insulated conductors in power installations – Part 4: Recommended values for current carrying capacities of cables for fixed installation and for flexible cables	IEC 60998-2-1 EN 60998-2-1 VDE 0613-2-1 /– Part 2-1: Particular requirements for connecting devices as separate entities with screw-type clamping units
EN 50110-1 VDE 0105-1 / Operation of electrical installations – Part 1: General requirements	IEC 60112 EN 60112 VDE 0303-11 / Method for determining the comparative and the proof tracking indices of solid insulation materials	IEC 60998-2-2 EN 60998-2-2 VDE 0613-2-2 /– Part 2-2: Particular requirements for connecting devices as separate entities with screwless-type clamping units
IEC 60664-1 EN 60664-1 VDE 0110-1 / Insulation coordination for equipment within low-voltage systems – Part 1: Principles, requirements and tests	IEC 60529 EN 60529 VDE 0470-1 / Degrees of protection provided by enclosures (IP Code) – Testing equipment and testing method	IEC 60998-2-3 EN 60998-2-3 VDE 0613-2-3 /– Part 2-3: Particular requirements for connecting devices as separate entities with insulation-piercing clamping units
IEC 60204-1 EN 60204-1 VDE 0113-1 / Safety of machinery – Electrical equipment of machines – Part 1: General requirements	IEC 61439-1 EN 61439-1 VDE 0660-600-1 / Low-voltage switchgear and control-gear assemblies – Part 1: General rules	IEC 60947-1 EN 60947-1 VDE 0660-100 / Low-voltage switchgear and controlgear – Part 1: General rules
IEC 61140 EN 61140 VDE 0140-1 / Protection against electric shock – Common aspects for installation and equipment	IEC 61439-3 EN 61439-3 VDE 0660-600-3 /– Low-voltage switchgear and control-gear assemblies – Part 3: Distribution boards intended to be operated by ordinary persons (DBO)	IEC 60947-7-1 EN 60947-7-1 VDE 0611-1 /– Part 7-1: Ancillary equipment – Terminal blocks for copper conductors
IEC 60079-0 EN 60079-0 VDE 0170-1 / Hazardous areas – Part 0: Equipment – General requirements	IEC 61643-11 EN 61643-11 VDE 0675-6-11 / Low-voltage surge protective devices – Part 11: Surge protective devices connected to low-voltage power systems – Requirements and test methods	IEC 60947-7-2 EN 60947-7-2 VDE 0611-3 /– Part 7-2: Ancillary equipment – Ground conductor terminal blocks for copper conductors
IEC 60079-7 EN 60079-7 VDE 0170-6 / Explosive atmospheres – Part 7: Equipment protection by increased safety "e"	IEC 60335-1 EN 60335-1 VDE 0700-1 / Safety of household and similar electrical appliances – Part 1: General requirements	IEC 60947-7-3 EN 60947-7-3 VDE 0611-6 /– Part 7-3: Ancillary equipment – Safety requirements for fuse terminal blocks
IEC 60079-11 EN 60079-11 VDE 0170-7 / Hazardous areas – Part 11: Equipment protection by intrinsic safety "i"	IEC 60598-1 EN 60598-1 VDE 0711-1 / Lighting fixtures – Part 1: General requirements and tests	VDE 0611-4 / Rail-mount terminal blocks for connection of copper conductors; – Multi-level distribution rail-mount terminal blocks up to 6 mm ²
IEC 60079-14 EN 60079-14 VDE 0165-1 / Hazardous areas – Part 14: Electrical installations design, selection and erection	IEC 60715 EN 60715 /– Standardized mounting on rails for mechanical support of electrical devices in switchgear and control-gear installations	IEC 61984 EN 61984 VDE 0627 / Connectors – Safety requirements and tests
IEC 60079-15 EN 60079-15 VDE 0170-16 / Explosive atmospheres – Part 15: Equipment protection by type of protection "n"	IEC 60999-1 EN 60999-1 VDE 0609-1 / Connecting devices – Electrical copper conductors – Safety requirements for screw-type and screwless-type clamping units – Part 1: General requirements and particular requirements for clamping units for conductors from 0.2 mm ² up to 35 mm ²	

Tests and Testing Procedures per IEC/EN Standards

Products such as connecting devices, rail-mount terminal blocks and connectors, etc., have their own product-specific test specifications. The following sections describe the most important tests and are limited to a description of the test procedures and an explanation of the test purpose. The data shown (e.g., voltages, temperatures, forces) only serve as illustration and may differ depending on the test.

Mechanical Tests

All WAGO products meet requirements for the following mechanical tests:

• Termination Requirements

Conductor Termination

Two WAGO connection systems are proven in the field of Spring Pressure Connection Technology:

The **PUSH WIRE® connection** for applications requiring solid conductors (e.g., for lighting and building wiring, telecommunications, house communication or alarm systems).

Conductor range:

0.2 ... 4 mm² / 24 ... 12 AWG

The **universal CAGE CLAMP® spring pressure connection system** for solid, stranded and fine-stranded conductors, designed for a variety of industrial, electrical and electronic applications (e.g., fine-stranded conductors in the elevator industry, in power stations, in the chemical and automotive industry, and aboard ships).

Conductor range:

0.08 ... 35 mm² (28 ... 2 AWG)

The **Push-in CAGE CLAMP® connection** takes universal CAGE CLAMP® connections further by allowing the termination of 0.2 ... 16 mm² (24 ... 6 AWG) solid, stranded and fine-stranded conductors (25 mm²/4 AWG only "f-st") and offering all the benefits and safety of the original CAGE CLAMP®. Furthermore, the Push-in CAGE CLAMP® connection technology allows solid, stranded and fine-stranded conductors with ferrules from 0.5 to 16 mm² (20 ... 6 AWG) to be terminated by simply pushing them in.

The conductor entry hole is perfectly suited for the insulation diameter of the rated conductor cross section, thus providing good conductor guidance.

This is particularly important for vibration-prone applications.

Fine-stranded conductors of a small or very small size are highly flexible, and deform when pushed against the conductor stop in terminal blocks. As a result, the conductor insulation – not the copper conductor – may be clamped, causing intermittent contact or no contact at all.

In order to prevent conductor insulation from being inserted into the clamp, insulation stops are available for WAGO rail-mount terminal blocks up to 4 mm² (12 AWG), even providing protection for 0.08 mm² (28 AWG) conductors (see Section 5).

Rated Cross Sections and Connectable Conductors

I. Per IEC 60999-1 / EN 60999-1 / VDE 0609-1, Table 1:

Rated Cross Section	Theoretical Largest Conductor Diameter							Connectable Conductor	
	Metric			AWG				Rigid	Flexible
	Rigid		Flexible	Rigid		Flexible			
	Solid	Stranded		b)	b) Class B	c) Class I, K, M Stranded			
mm ²	mm	mm	mm	Conductor Size	mm	mm	mm		
0.2	0.51	0.53	0.61	24	0.54	0.61	0.64	To be defined in the corresponding product standard	
0.34	0.63	0.66	0.8	22	0.68	0.71	0.8		
0.5	0.9	1.1	1.1	20	0.85	0.97	1.02		
0.75	1	1.2	1.3	18	1.07	1.23	1.28		
1	1.2	1.4	1.5	–	–	–	–		
1.5	1.5	1.7	1.8	16	1.35	1.55	1.6		
2.5	1.9	2.2	2.3 ^{a)}	14	1.71	1.95	2.08		
4	2.4	2.7	2.9 ^{a)}	12	2.15	2.45	2.7		
6	2.9	3.3	3.9 ^{a)}	10	2.72	3.09	3.36		
10	3.7	4.2	5.1	8	3.34	3.89	4.32		
16	4.6	5.3	6.3	6	4.32	4.91	5.73		
25	–	6.6	7.8	4	5.45	6.18	7.26		
35	–	7.9	9.2	2	6.87	7.78	9.02		

NOTE: The diameters of the largest rigid and flexible conductors are based on Table 1 of IEC 60228 A/IEC 60344 and on ASTM B172-71 [4], IEC Publication S-19-81 [5], IEC Publication S-66-524 [6], as well as IEC Publication S-66-516 [7] for AWG conductors.

^{a)} Dimensions for Class 5 flexible conductors only (IEC 60228 A)

^{b)} Nominal diameter +5%

^{c)} Largest diameter for conductors of classes I, K, M + 5%

In practical use, the conductor cross sections are approximately 5% below the values stated in the table!

The IEC 60999-1/EN 60999-1/VDE 0609-1 Specification (Section 7.1) requires that:

Clamping units must be able to connect unprepared conductors.

Under normal operating conditions, direct clamping (i.e., directly connecting a conductor to the terminal block's current bar) provides optimal contact quality, because all risk factors arising from anti-splaying methods are prevented.

Occasionally, conductor anti-splaying protection may be required, including various methods (see illustrations below).

Special requirements apply only in special application areas exposed to extremely corrosive atmospheres.

In this case, we recommend using either solid copper conductors or fine-stranded copper conductors with properly crimped, tin-coated copper ferrules or copper pin terminals.

As with solid copper conductors, the fine strands are crimped into a dense inner core. Crimping prevents ingress of aggressive atmospheres (depending on the ppm concentration), which can diffuse into the conductor bundle along the individual strands and deposit between individual strands and the clamping point.

One Conductor per Clamping Unit

A number of DIN VDE, EN, IEC directives mandate or recommend that only one conductor must be connected per clamping unit.

In accordance with DIN VDE 0611, Part 4, 02.91, Section 3.1.9, multi-level distribution rail-mount terminal blocks must be dimensioned so that a single (solid, stranded or fine-stranded) conductor of the nominal cross section can be connected at each terminal point.

Other VDE, EN and IEC specifications also recommend the connection of only one conductor per clamping unit, unless the clamping unit is specifically tested and approved for the connection of several conductors, for example:

- VDE 0609, Part 1, 12.00 / EN 60999-1:2000/ IEC 60999-1:1999, Section 7.1
- VDE 0660, Part 600, 06.12 / EN 61439-1:2011 / IEC 61439-1, Section 8.6.3
- VDE 0113, Part 1, 06.07 / EN 60204-1:2006 / IEC 60204-1:2016, Section 13.1.1.

One conductor per clamping unit is therefore recommended to meet the safety requirements of these relevant specifications. This WAGO principle is the basis for a number of other technical and economic advantages:

- Each conductor may be terminated or removed without affecting previously connected conductors.
- Where re-wiring is required, only the conductor to be changed is removed from the clamping point, all other conductors remain safely clamped.
- Each conductor is clamped independently.
- Any conductor size combination can be connected.

WAGO rail-mount terminal blocks offer different solutions to increase the number of clamping points.

The most common way is by branching one conductor into two or three conductors. WAGO offers 3- and 4-conductor terminal blocks, making additional jumpers unnecessary.

II. Per IEC 60999-2, Table 1:

Rated Cross-Section	Theoretical Largest Conductor Diameter					Connectable Conductor	
	Metric		AWG/kcmil				
	Rigid Stranded	Fine-Stranded ^{a)}	Gauge	Rigid Stranded	Fine-Stranded	Rigid	Flexible
mm ²	mm	mm		mm	mm		
50	9.1	11	1/0	9.64	12.08	To be defined in the corresponding product standard	
70	11	13.1	2/0	11.17	13.54		
95	12.9	15.1	3/0	12.54	15.33		
-	-	-	4/0	14.08	17.22		
120	14.5	17	250	15.34	19.01		
150	16.2	19	300	16.8	20.48		
185	18	21	350	18.16	22.05		
-	-	-	400	19.42	24.05		
240	20.6	24	500	21.68	26.57		
300	23.1	27	600	23.82	30.03		

Dimensions for Class 5 flexible conductors only (IEC 60228 A)

NOTE: The diameters of the largest rigid and flexible conductors are based on Table 1 and Table 3 of IEC 3 A/IEC 60228 and on ASTM B172-71 [1], IECA Publication S-19-81 [2], IECA Publication S-66-524 [3], as well as IECA Publication S-66-516 [7] for AWG conductors.



Tip-bonded conductor



Tin-plated copper ferrule (gas-tight crimped)

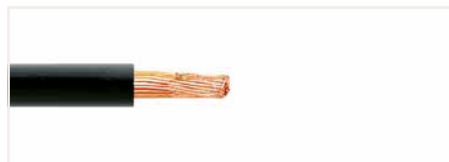

Ultrasonically bonded conductor

Anti-splaying methods require a terminal block one size larger than the nominal cross section of the conductor to be terminated. Ferruled conductor cross sections specified for individual products are based on WAGO's Variocrimp square crimping technology. Gas-tight, crimped twin ferrules may be used, provided the ferrule is inserted all the way into the clamping unit and that there is a sufficient clearance and creepage distance between adjacent potentials.



Crimped pin terminal (gas-tight), preferably made of copper with a tin-plated surface

Tests and Testing Procedures per IEC/EN Standards (continued)

Mechanical Tests (continued)

- Pull-Out Test per IEC/EN 60947-7-1, IEC/EN 60998-2-2, IEC/EN 60999-1

The pull-out test simulates the mechanical stress on the clamping unit when, for example, the installer pushes the conductor aside to better access/operate the adjacent clamping unit, or verifies if the conductor is connected properly by briefly pulling on it.

During the test, a pulling force is applied without jerking, for one minute, to the connected conductor. The pulling force is selected according to the cross-sectional area. The larger the cross section of the conductor, the higher the pull-out force that is selected. For example, the pulling force is 40 N for a conductor having a cross section of 1.5 mm² (16 AWG) and 100 N for a conductor with a cross section of 16 mm² (6 AWG). The values specified by these standards are the same for both screw clamp and spring clamp terminal blocks. During the test, the conductor must neither slip out of the clamping unit, nor break near the clamping unit.

Conductor Pull-Out Forces

The clamping units of screwless terminal blocks must withstand the pull-out forces as follows:

IEC 60947-1/EN 60947-1/VDE 0660-100, Table 5:
Low-voltage switchgear and controlgear, General rules

IEC 60947-7-1/EN 60947-7-1/
VDE 0611-1, Rail-mount terminal blocks for copper conductors

IEC 60998-2-1/EN 60998-2-1/
VDE 0613-2-1, Table 104:

IEC 60998-2-2/EN 60998-2-2/
VDE 0613-2-2, Table 103:

Connecting devices for low-voltage circuits for household and similar purposes

Particular requirements for connecting devices as separate entities with screw-clamp or screwless terminal blocks.

IEC 60999-1/EN 60999-1/VDE 0609-1, Table 3:

IEC 60999-2/EN 60999-2/VDE 0609-101, Table 2:

Safety requirements for screw-clamp and screwless clamping units for electrical copper conductors

Rated Cross-Section		Pull-Out Forces per IEC/EN		
mm ²	AWG/kcmil	60947-7-1	60998-2-2	60999-1/-2
		N	N	N
0.2	24	10	10	10
0.34	22	15	15	15
0.5	20	20	20	20
0.75	18	30	30	30
1	–	35	35	35
1.5	16	40	40	40
2.5	14	50	50	50
4	12	60	60	60
6	10	80	80	80
10	8	90	90	90
16	6	100	100	100
25	4	135	135	135
–	3	156		
35	2	190	190	190
–	1	236		
50	1/0	236		236
70	2/0	285		285
95	3/0	351		351
–	4/0	427		427
120	250	427		427
150	300	427		427
185	350	503		503
–	400	503		503
240	500	578		578
300	600	578		578

• Shock Test per IEC/EN 60068-2-27; IEC/EN 61373 (Railway Applications)

The shock test is similar to the vibration test except that, instead of continuous vibrations, single shocks are applied to the specimen. Shock tests are usually performed with an acceleration of 20g, for example, over a period of 11 ms. Tests for special requirements often call for much higher values.

Like the vibration tests, shock tests are primarily used to test the voltage drop variation or contact breaks, etc.

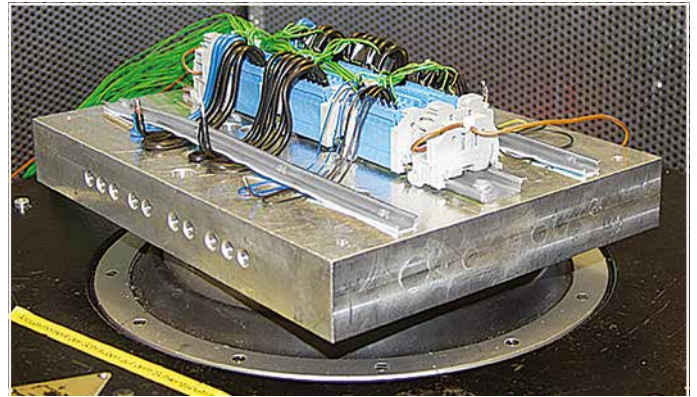
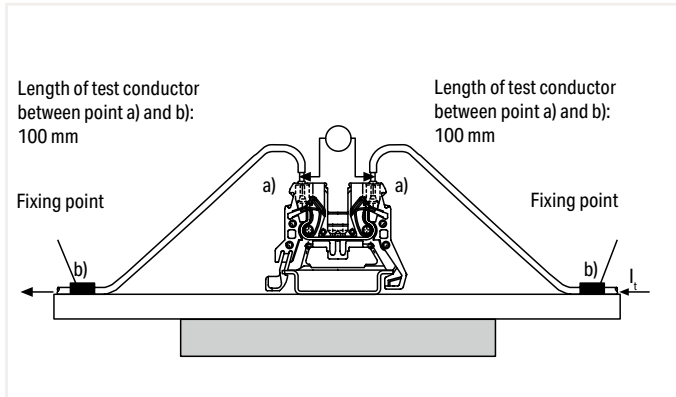

Example: Shock requirement
 per IEC/EN 60068-2-27 (half-sine shock)
 100g acceleration, 6 ms duration
 Shock direction: 3 axes (3 shocks each in positive and negative direction)

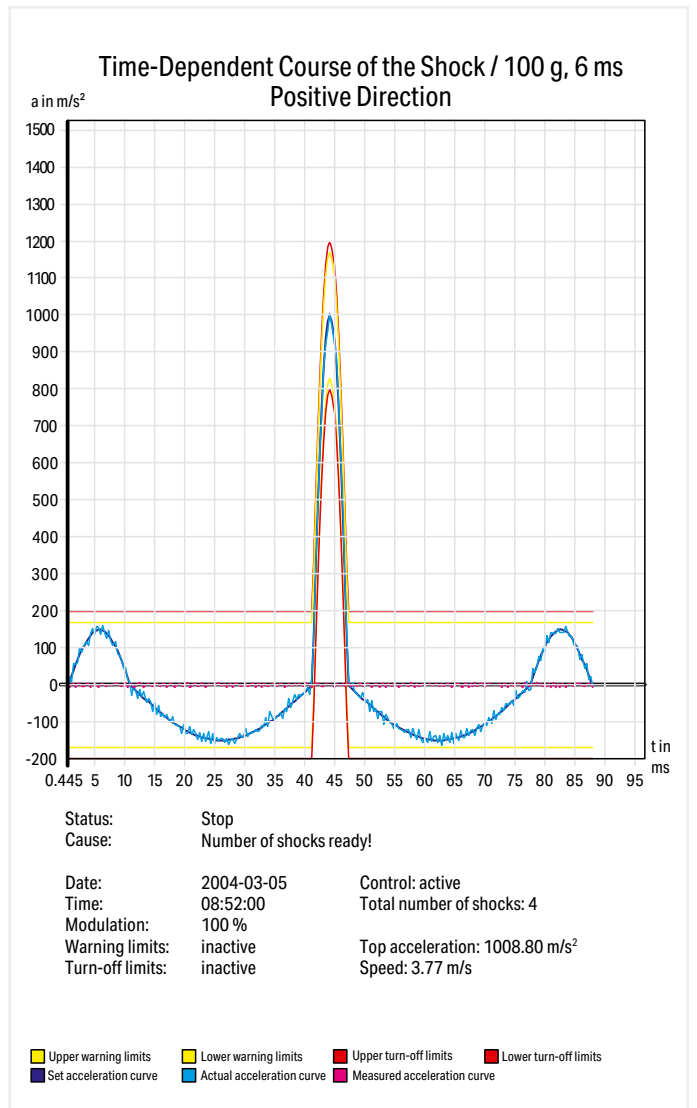
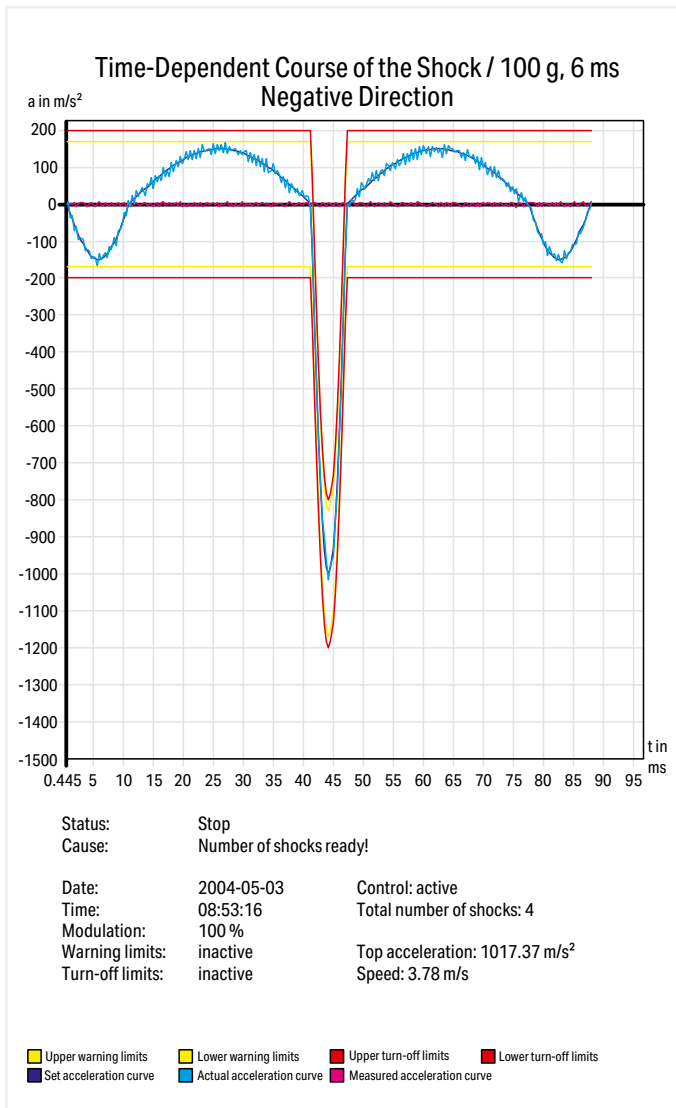

Tests and Testing Procedures per IEC/EN Standards (continued)

Mechanical Tests

- Vibration Test per IEC/EN 60068-2-6; DNV GL, LR (Marine Applications); EN 61373 (Railway Applications)

The vibration test determines whether vibrations, such as those produced in the vicinity of machines or in vehicles, will permanently affect the electrical connection, or if contact breaks will occur during vibrations. Using a vibration table, the test specimen is subjected to vibration in each of the X, Y and Z axes (see pictures).

The amplitude, acceleration and, in particular, the frequency of the vibration must vary during the test.

In a common test procedure, for example, a wide frequency band is continuously run up to 2000 Hz, at different accelerations up to 20g and different amplitudes up to 20 mm. Test duration is 90 minutes per axis.



Other test types are performed using a single fixed frequency. The exact test procedure may vary considerably, depending on how the product will be used. Some test specifications require the determination of possible resonant frequencies, i.e., determining if resonance occurs within the frequency spectrum to be passed through. Analyzing the specimen behavior under the influence of resonant frequencies is performed using a special testing procedure.

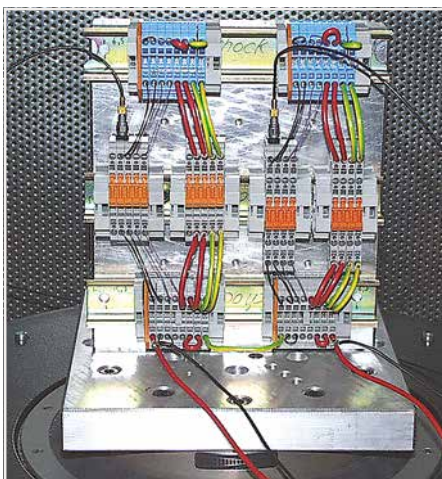

Beyond these standard procedures, each market segment performs additional testing. Examples include railway authorities testing rolling electrical equipment, or the testing performed multiple marine agencies (e.g., DNV GL Group, Lloyd's Register of Shipping). Though the requirements of such testing procedures are particularly demanding, test arrangements are identical for all of them. During vibrations, possible contact breaks are monitored on an oscilloscope. Voltage drop is measured before and after the test to detect permanent failures, i.e., checking if electrical resistance at the clamping unit has not increased beyond the permissible limit. The smaller this value is, the smaller the contact resistance of the clamping unit.

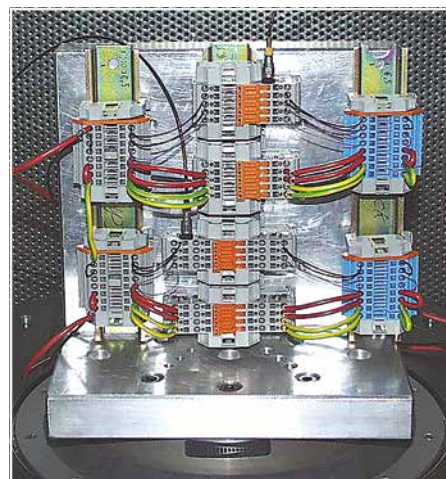

The test is passed if:

- the conductor has neither slipped out of the terminal block nor been damaged
- the maximum permissible voltage drop has not been exceeded
- and neither contact breaks have occurred nor a defined break time has been exceeded.

The test specimen must not be damaged in any way that might affect future use.

Since their inception, both CAGE CLAMP® and Push-in CAGE CLAMP® connections have been routinely tested for their resistance to vibration in connection with approval tests.

Additionally, WAGO conducts special self-resonance behavior tests on clamping systems, using different terminal block and conductor arrangements. In these tests, a wide frequency band is continuously run up to 2000 Hz, at different accelerations up to 20g and different amplitudes up to 20 mm. The figure provides an example of a self-resonance vibration test configuration.

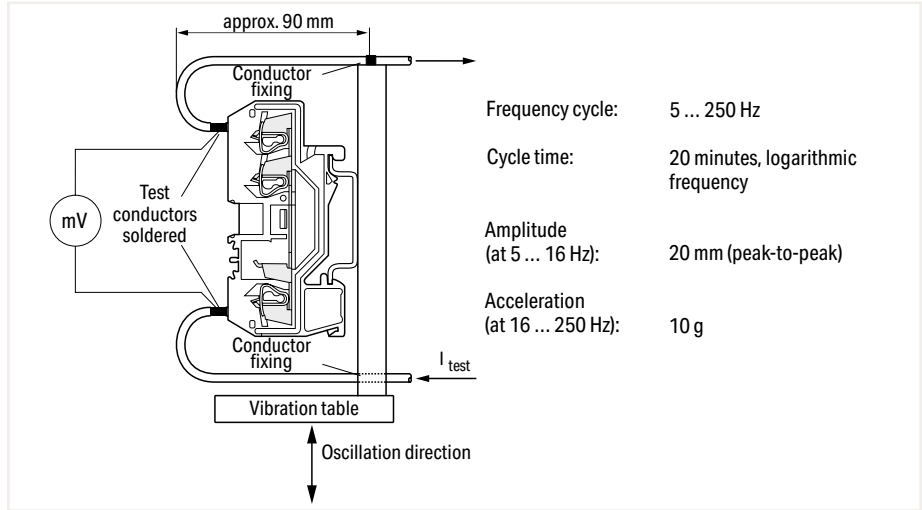

Frequency cycle: 5 ... 250 Hz
 Cycle time: 20 minutes, logarithmic frequency
 Amplitude (at 5 ... 16 Hz): 20 mm (peak-to-peak)
 Acceleration (at 16 ... 250 Hz): 10 g

Self-resonance vibration test set-up

All WAGO spring clamp connections meet these test requirements.

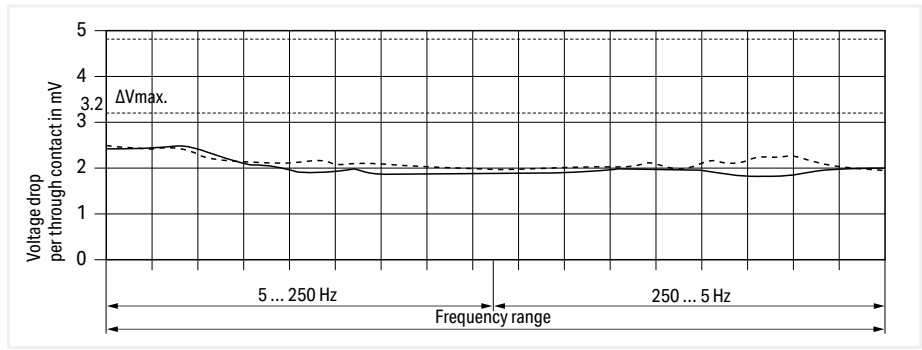

Frequency cycle
 Rail-mount terminal block: Item no. 280-681
 Test current: 1/10 I_N = 2,4 A
 ----- Test specimen no. 1
 - - - - - Test specimen no. 2

Tests and Testing Procedures per IEC/EN Standards (continued)

Electrical Tests

All WAGO products meet requirements for the following electrical tests:

- Temperature-Rise Test per IEC/EN 60947-7-1

The temperature-rise test examines the clamping unit – including the surrounding insulation – at rated current, over-current and short-circuit current levels.

Unless otherwise specified in the related equipment specification, e.g., by specifying the nominal currents of the equipment, terminal blocks and connectors are tested with current loads as specified in the respective construction specification.

For rail-mount terminal blocks complying with IEC 60947-7-1/EN 60947-7-1/VDE 0611-1, or terminal blocks complying with IEC 60998-1/EN 60998-1/ VDE 0613-1, the temperature rise must not exceed 45 Kelvin.

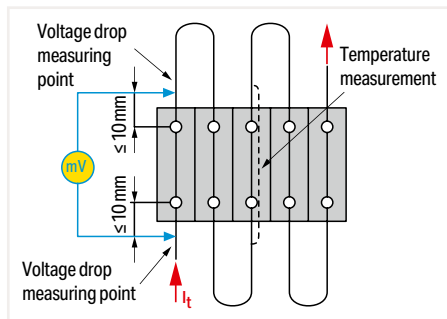

Test arrangement: "Temperature-Rise Test"

Rated Cross-Section	Test Current per IEC/EN		Conductor Size	Test Current per IEC/EN
	60947-7-1 Table 4	60998-1 Table 2		
mm ²	A	A	AWG/kcmil	A
0.2	4	4	24	4
0.34	5	5	22	6
0.5	6	6	20	8
0.75	9	9	18	10
1	13.5	13.5	-	16
1.5	17.5	17.5	16	16
2.5	24	24	14	22
4	32	32	12	29
6	41	41	10	38
10	57	57	8	50
16	76	76	6	67
25	101	101	4	90
35	125	125	2	121
-			1	139
50	150		1/0	162
70	192		2/0	185
95	232		3/0	217
-			4/0	242
120	269		250 kcmil	271
150	309		300 kcmil	309
185	353		350 kcmil	353
240	415		500 kcmil	415
300	520		600 kcmil	520

• Current-Carrying Capacity Curve per IEC/EN 60512-5-2

Both the design requirements and the current-carrying capacity of a connector must be checked by the user when selecting connectors. This data depends on the following factors: connected conductor cross section, surrounding air temperature, number of simultaneously loaded poles, connector's internal resistance, as well as PCB layout and connector materials if required. In accordance with IEC/EN 60512-5-2, the relationship between current, surrounding air temperature and temperature rise up to the connector's upper temperature limit is illustrated via current-carrying capacity curve. The connector must only be operated up to this temperature limit (sum of the self-generated heat and the surrounding air temperature) without being damaged or destroyed during operation.

Functioning of a current-carrying capacity curve per EN 60512-5-2 is shown by an application using a current-carrying capacity curve for the X-COM®-SYSTEM:

This application requires each pole of a 4-pole connector be subjected to a load of 32 A. Based on the basic curve determined for this pole number with a conductor cross section of 4 mm², it has been determined the maximum surrounding air temperature is 42°C (107.6°F). The current must be reduced at higher surrounding air temperatures, e.g., to 19 A at an surrounding air temperature of 80°C (176°F).

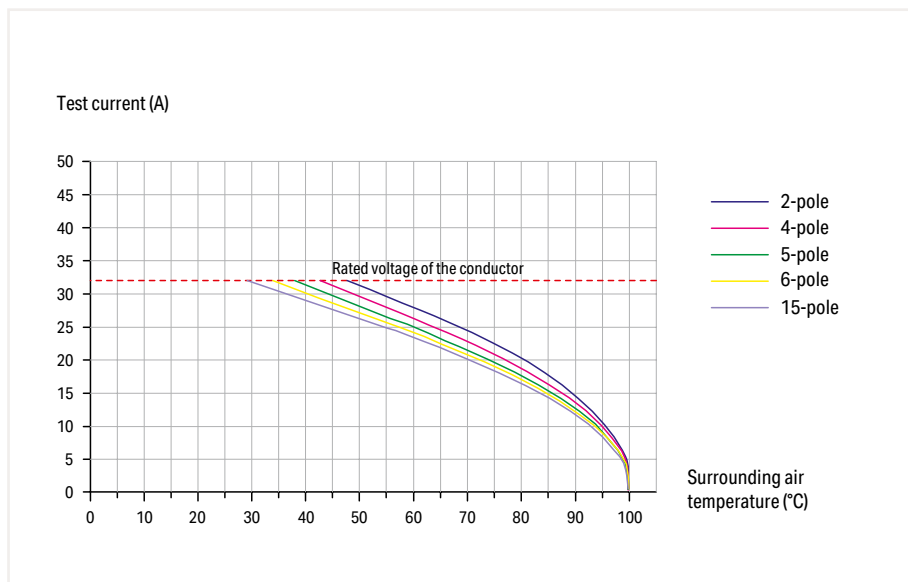

1-conductor/1-pin carrier terminal block (769-176)
Conductor cross section: 4 mm² (12 AWG)

1-conductor female plugs (769-102 to 769-115)
Conductor cross section: 4 mm² (12 AWG)
Conductor loop length: 1 m

Tests and Testing Procedures per IEC/EN Standards (continued)

Electrical Tests (continued)

- Voltage Drop Test per IEC/EN 60947-7-1

The voltage drop test evaluates clamping point quality under stress such as vibration, temperature change, industrial climate and salt spray, in order to verify that the contact point is gas-tight.

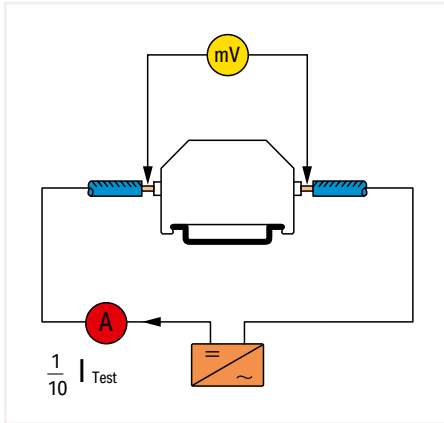

Test arrangement: "Voltage Drop Test"

The CAGE CLAMP® and Push-in CAGE CLAMP® connections enclose and contain fine-stranded conductors. Therefore, a variation of the voltage drop with solid and fine-stranded conductors is so small that its influence may be negligible for the practical application of the terminal blocks.

Typical voltage drop variations for solid and fine-stranded conductors of 280 to 285 Series CAGE CLAMP® Rail-Mount terminal Blocks:

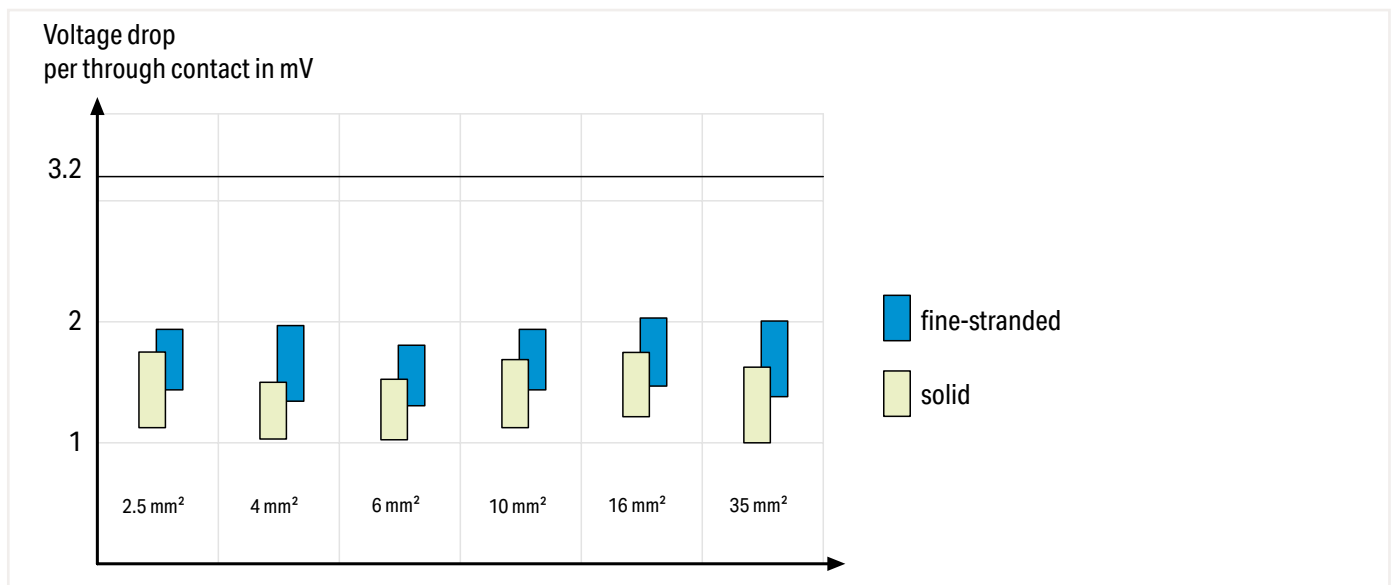

Example: Current load cycling test result for rail-mount terminal blocks (item no. 285-195) using 95 mm² (4/0 AWG) fine-stranded copper conductors:

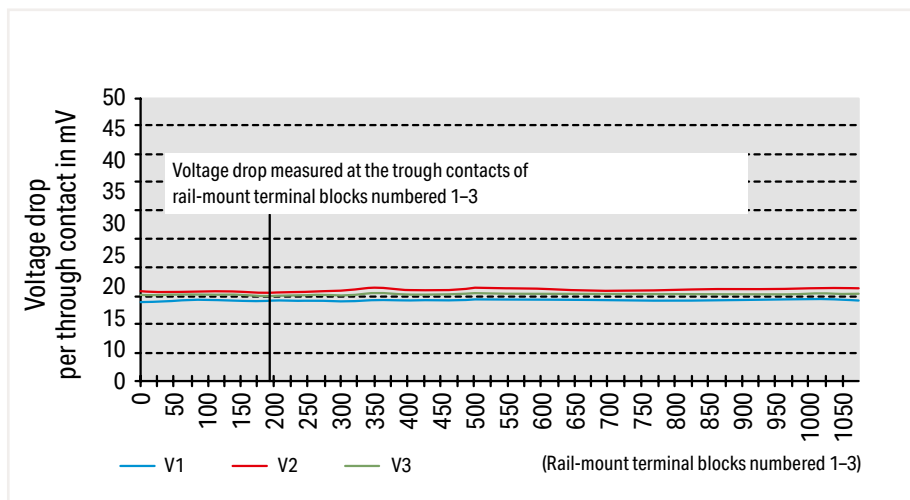

Voltage drop variation over longer periods under current load cycling conditions is shown for WAGO 285-195 (95 mm²/4/0 AWG) Rail-Mount Terminal Blocks using solid copper conductors. The diagram shows that the voltage drop is constant, far beyond the 192 cycles required in IEC 60947-7-1.

(The voltage drop was determined at the rated current.)

- Short-Time Withstand Current Test (Short-Circuit Withstand Capacity) per IEC/EN 60947-7-1

Apart from the rated current that can be constantly applied to an electrical device, operation-related short peak currents consistently occur in electrical installations, e.g., when motors are started. Also, in the event of a short circuit, a high current can flow for a short time until the fuse element melts. Terminal blocks and connecting devices must be able to withstand such conditions. For example, in the short-time withstand current test per IEC/EN 60947-7-1, a through rail-mount terminal blocks must be capable of withstanding for one second the rated short-time withstand current which corresponds to 120 A/mm^2 of its nominal cross section.

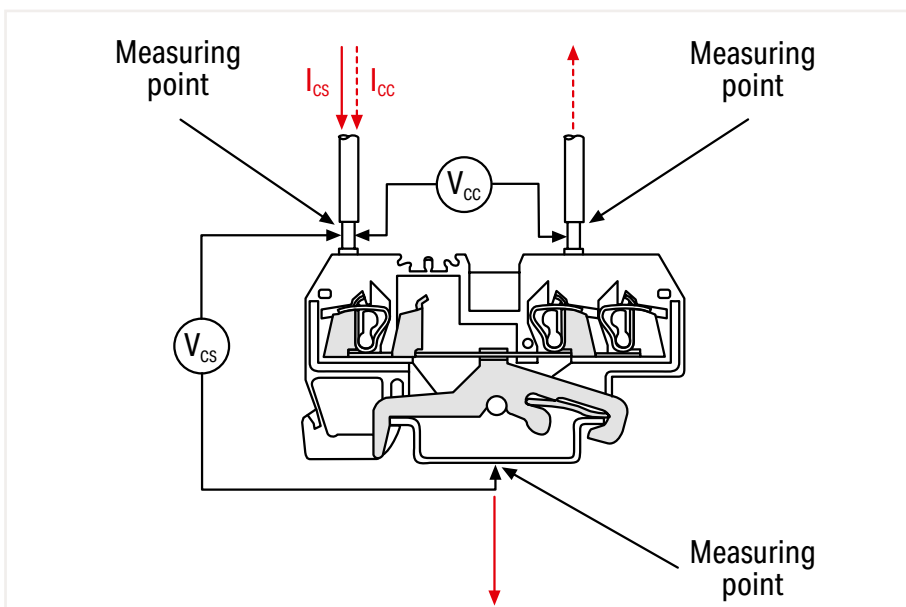
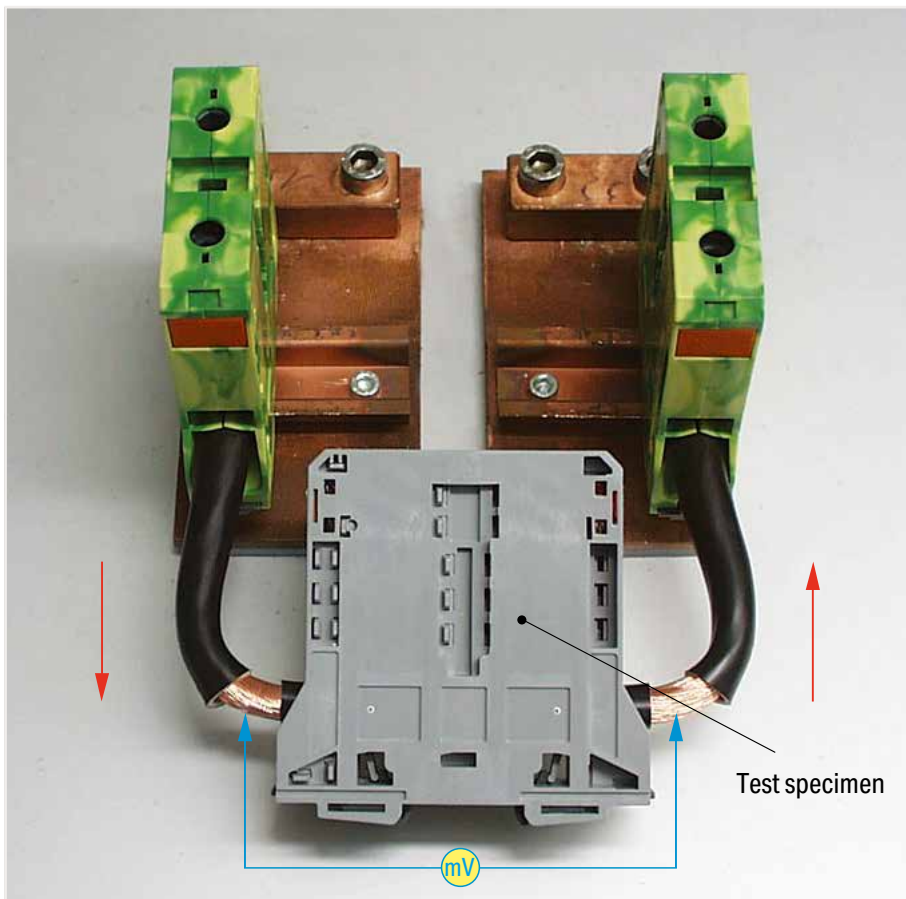

During the short-time withstand current test, the ground conductor rail-mount terminal blocks are subjected three times for one second each to a current load of 120 A/mm^2 . The pass criterion for the test is the voltage drop (limiting value and constant measured values).

Tests and Testing Procedures per IEC/EN Standards (continued)

Electrical Tests (continued)

• Insulation Parameters per IEC/EN 60664-1

Clearances and Creepage Distances

The following generally applies:

The equipment specification contains data for the measurement of clearances and creepage distances, or refers to the data contained in the new revised edition of the basic standard DIN EN 60664-1/VDE 0110-1. This standard contains new clearances and creepage distances in compliance with insulation coordination requirements. That is, the insulation parameters of equipment are assigned to:

- the anticipated surge voltages
- the parameters of the protection device against impulse voltage
- the anticipated environmental conditions and the protection measures against pollution.

This standard is based on IEC 60604-1.

Overvoltage Categories for Electrical Equipment:

A specific overvoltage category must be defined on the basis of the following, general description:

- Equipment in **overvoltage category I** is intended to be connected to the fixed electrical installations of buildings. Protective means are taken outside the equipment – either in the fixed installation or between the fixed installation and the equipment – to limit transient overvoltages to the specific level.
- Equipment in **overvoltage category II** is to be connected to the fixed electrical installations of buildings.
Note: Examples of such equipment are household appliances, portable tools and similar loads.
- Equipment in **overvoltage category III** is part of the fixed electrical installations and other equipment where a higher degree of availability is expected.
Note: Examples of such equipment are distribution boards, circuit breakers, wiring systems (IEV 826-16-08, including cables, bus bars, junction boxes, switches, socket outlets) in the fixed installation and equipment for industrial use and other equipment, e.g., stationary motors with permanent connection to the fixed installation.
- Equipment in **overvoltage category IV** is for use in or near the feed-in of electrical building installations upstream of the main distribution board in the direction of the network.
Note: Examples include electricity meters, primary overcurrent protection devices and ripple control units.

Clearances, Rated Surge Voltages, Overvoltage Categories, Pollution Degrees

Surge voltages (Table 1) are a decisive factor in determining clearances.

The basis forms the **overvoltage category**, i.e., the allocation of the equipment to the expected overvoltage, and the **conductor-ground voltage** derived from the nominal mains voltage in installations with a grounded Y (star) point.

In ungrounded installations, or installations where the conductor is not grounded, the voltage between conductors is applicable in the same way as conductor voltage to ground.

The rated surge voltage must be selected from Table F.1 corresponding to the overvoltage category specified and to the rated voltage of the equipment.

Table F.1 – Rated Surge Voltage for Equipment Energized Directly from the Low-Voltage Mains (DIN EN 60664-1/VDE 0110-1)

Voltage Curve: 1.2/50 μ s per IEC 60060-1/VDE 0432-1

Nominal voltage of the power supply system ¹⁾ (mains) per IEC 60038 ²⁾		Conductor-to-neutral voltage, derived from the nominal AC or DC voltage up to and including: V	Rated surge voltage ²⁾			
Three-phase V	Single-phase V		Overvoltage category ⁴⁾			
			I V	II V	III V	IV V
		50	330	500	800	1500
		100	500	800	1500	2500
	120 ... 240	150 ⁵⁾	800	1500	2500	4000
230 / 400 277 / 480		300	1500	2500	4000	6000
400 690		600	2500	4000	6000	8000
1000		1000	4000	6000	8000	12000

¹⁾ See Annex B for application to existing different low-voltage mains and their nominal voltages.

²⁾ Equipment with these rated impulse voltage levels can be used in installations complying with IEC 60364-4-443.

³⁾ The / mark indicates a 3-phase, 4-conductor system. The lower value is the conductor-to-neutral voltage, while the higher value is the conductor-to-conductor voltage. Where only one value is indicated, it refers to 3-phase, 3-conductor systems and specifies the conductor-to-conductor voltage.

⁴⁾ See 4.3.3.2.2 for an explanation of the overvoltage categories.

⁵⁾ The nominal voltages for single-phase systems in Japan are 100 V or 100 ... 200 V. The value for the rated impulse voltage is, however, derived from the voltage gaps conductor-to-neutral for a voltage level of 150 V (see Annex B).

The nominal supply voltage and the corresponding rated impulse voltage values apply for grounded and ungrounded circuits.

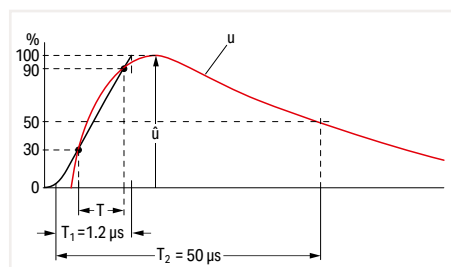

Voltage pulse: 1.2/50 μ s per EN 60060-1/VDE 0432-1

Pollution Degrees

Pollution factors are all solid, liquid or gaseous foreign matter which may reduce the dielectric strength or the specific surface resistance. Factors are divided into four classes based on expected environmental conditions:

		Examples of pollution degrees for assigned areas:
Pollution degree 1:	No pollution, or only dry, non-conductive pollution occurs. Pollution has no influence.	Open, unprotected insulated equipment in air-conditioned or clean, dry rooms
Pollution degree 2:	Only non-conductive pollution occurs. Occasional, temporary conductivity caused by condensation can also be expected.	Open, unprotected insulated equipment in occupied areas, shops, laboratories, mechanical workshops and medical rooms.
Pollution degree 3:	Conductive pollution occurs, or dry, non-conductive pollution occurs which will become conductive due to condensation.	Open, unprotected insulated equipment in industrial, business and farming areas (e.g., unheated rooms, workshops and boiler rooms)
Pollution degree 4:	The pollution generates persistent conductivity caused by conductive dust, rain or wet conditions.	Open, unprotected insulated equipment for outdoor use

Dimensioning Clearances

(DIN EN 60664-1/VDE 0110-1, Table F.2)

Select the minimum clearances in accordance with the rated surge voltages and pollution degrees. To maximize the operating life of the equipment, do not go below these minimum clearances.

Table F.2 contains a list of information for Case A, the inhomogeneous field and for Case B, the homogeneous field.

This involves an electric field with essentially constant (Case B) or non-constant (Case A) voltage gradients between the electrodes.

Equipment with a clearance that is dimensioned per Case A, in other words rated for the most unfavorable case, requires no verification by the impulse voltage test.

Equipment with a clearance that is dimensioned per Case B, or between A and B, requires verification by the impulse voltage test.

The clearances shown in Table F.2 are applicable for an installation height of up to 2000 m above sea level.

Values for clearances above 2000 m must be multiplied by a high correction factor in accordance with Table A.2.

Table F.2 – Clearances to Withstand Transient Overvoltages
DIN EN 60664-1/VDE 0110-1

Required Impulse Withstand Voltage ¹⁾⁵⁾	Minimum Clearances in Air up to 2000 m Above Sea Level					
	Case A Inhomogeneous Field (see 3.15)			Case B Homogeneous Field (see 3.14)		
	Pollution Degree ⁶⁾			Pollution Degree ⁶⁾		
	1	2	3	1	2	3
kV	mm	mm	mm	mm	mm	mm
0.33 ²⁾	0.01	0.2 ³⁾⁴⁾	0.8 ⁴⁾	0.01	0.2 ³⁾⁴⁾	0.8 ⁴⁾
0.4	0.02			0.02		
0.5 ²⁾	0.04			0.04		
0.6	0.06			0.06		
0.8 ²⁾	0.10			0.10		
1	0.15			0.15		
1.2	0.25	0.25	0.2	0.3	0.3	
1.5 ²⁾	0.5	0.5	0.3	0.45	0.45	
2	1	1	1	0.6	0.6	
2.5 ²⁾	1.5	1.5	1.5	0.8	0.8	
3	2	2	2	1.2	1.2	1.2
4 ²⁾	3	3	3	1.5	1.5	1.5
5	4	4	4	2	2	2
6 ²⁾	5.5	5.5	5.5	3	3	3
8 ²⁾	8	8	8	3.5	3.5	3.5
10	11	11	11	4.5	4.5	4.5
12 ²⁾	14	14	14	5.5	5.5	5.5
15	18	18	18	8	8	8
20	25	25	25	10	10	10
25	33	33	33	12.5	12.5	12.5
30	40	40	40	17	17	17
40	60	60	60	22	22	22
50	75	75	75	27	27	27
60	90	90	90	35	35	35
80	130	130	130	45	45	45
100	170	170	170			

¹⁾ This voltage is for:

- Functional insulation: the maximum impulse voltage expected to occur across the clearance (see 5.1.5)
- Basic insulation directly exposed to or significantly influenced by transient overvoltages from the low-voltage mains (see 4.3.3.3, 4.3.3.4.1 and 5.1.6): the rated impulse voltage for the equipment;
- Other basic insulation (see 4.3.3.4.2): the highest impulse voltage that can occur in the circuit
For reinforced insulation, see 5.1.6.

²⁾ Preferred values specified in 4.2.3

³⁾ For printed wiring material, the values for pollution degree 1 apply, except that the value must not be less than 0.04 mm, as specified in Table F.4.

⁴⁾ The minimum clearances given for pollution degree 2 and 3 are based on the reduced withstand characteristics of the associated creepage distance under humidity conditions (see IEC 60664-5).

⁵⁾ For parts or circuit within equipment subject to surge voltages based on 4.3.3.4.2, interpolation of values is allowed. However, standardization is achieved by using the preferred series of impulse voltage values based on 4.2.3.

⁶⁾ The dimensions for pollution degree 4 are as specified for pollution degree 3, except that the minimum clearance is 1.6 mm.

Tests and Testing Procedures per IEC/EN Standards (continued)

Electrical Tests (continued)

• Insulation Parameters per IEC/EN 60664-1 (continued)



Creepage Distances, Rated Voltages, Material Groups

Criteria for dimensioning creepage distances are the rated voltages, pollution degrees and material groups.

The pollution degrees specified for the clearances, and its quoted allocation to locations, is also applicable for creepage distances.

Tables F.3 a and F.3 b of DIN EN 60664-1/ VDE 0110-1 contain the rated voltages that have to be considered for dimensioning the minimum creepage distances.

Table F.3a – Single-Phase, 3- or 2-Conductor, AC or DC Systems

Nominal Voltage of the Power Supply System (Mains)*	Voltages for Table F.4	
	For insulation conductor-to-conductor ¹⁾	For insulation conductor-to-ground ¹⁾
	All systems 	Three-conductor systems, center-point grounded 
V	V	V
12.5	12.5	
24 25	25	
30	32	
42 48 50**	50	
60	63	
30 to 60	63	32
100**	100	
110 120	125	
150**	160	
200	200	
110 to 200	200	100
220	250	
110 to 220 120 to 240	250	
300**	320	
220 to 440	500	250
600**	630	
480 to 960	1000	500
1000**	1000	

¹⁾ Conductor-to-ground insulation level for non-grounded or impedance-grounded systems equals that for conductor-to-conductor, as the operating voltage to ground of any conductor can, in practice, approach full conductor-to-conductor voltage. This is because the actual voltage to ground is determined by the insulation resistance and capacitive reactance of each conductor to ground; thus, low (but acceptable) insulation resistance of one conductor can in effect ground it and raise the other two to full conductor-to-conductor voltage to ground.

*For the relationship to rated voltage, see 4.3.2.

**These values correspond to the values given in Table F.1.

Altitude m	Standard Air Pressure (in kPa)	Multiplier for Clearances
2000	80	1
3000	70	1.14
4000	62	1.29
5000	54	1.48
6000	47	1.7
7000	41	1.95
8000	35.5	2.25
9000	30.5	2.62
10000	26.5	3.02
15000	12	6.67
20000	5.5	14.5

Table F.3b – Single-Phase, 4- or 3-Conductor AC Systems

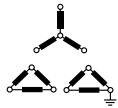
Nominal Voltage of the Power Supply System (Mains)*	Voltages for Table F.4		
	For insulation conductor-to-conductor ¹⁾	For insulation conductor-to-ground ¹⁾	
	All systems	Three-phase, 4-conductor systems with grounded neutral conductor ²⁾	Three-phase, 3-conductor systems, non-grounded ¹⁾ or grounded conductor
V	V		
V	V	V	V
60	63	32	63
110 120 127	125	80	125
150**	160		160
200	200		200
208	200	125	200
220 230 240	250	160	250
300**	320		320
380 400 415	400	250	400
440	500	250	500
480 500	500	320	500
575	630	400	630
600**	630		630
660 690	630	400	630
720 830	800	500	800
960	1000	630	1000
1000**	1000		1000

¹⁾ Conductor-to-ground insulation level for non-grounded or impedance-grounded systems equals that for conductor-to-conductor, as the operating voltage to ground of any conductor can, in practice, approach full conductor-to-conductor voltage. This is because the actual voltage to ground is determined by the insulation resistance and capacitive reactance of each conductor to ground; thus, low (but acceptable) insulation resistance of one conductor can in effect ground it and raise the other two to full conductor-to-conductor voltage to ground.

²⁾ For equipment used on both three-phase, 4-conductor and three-phase, 3-conductor systems, grounded and non-grounded, use only the values for 3-conductor systems.

*For the relationship to rated voltage, see 4.3.2.

**These values correspond to the values given in Table F.1.

Material Groups

Insulation materials are classified into four groups according to their Comparative Tracking Index (CTI) as follows:

Material Group I: $600 \leq \text{CTI}$

Material Group II: $400 \leq \text{CTI} < 600$

Material Group IIIa: $175 \leq \text{CTI} < 400$

Material Group IIIb: $100 \leq \text{CTI} < 175$

The CTI values above refer to values obtained in accordance with DIN EN 60664-1/VDE 0110-1 on samples specially made for this purpose and tested with Solution A.

Tests and Testing Procedures per IEC/EN Standards (continued)

Electrical Tests (continued)

• Insulation Parameters per IEC/EN 60664-1 (continued)

Table F.4 – Creepage Distances to Avoid Failure due to Tracking
DIN EN 60664-1/VDE 0110-1

Voltage ¹⁾ (RMS)	Minimum Creepage Distances								
	Printed Circuits		Pollution Degree						
	Pollution Degree		Pollution Degree						
	1 All Material Groups mm	2 All Material Groups except IIIb mm	1 All Material Groups mm	2 Material Group I mm	2 Material Group II mm	2 Material Group III mm	3 Material Group I mm	3 Material Group II mm	3 Material Group III ²⁾ mm
V									
10	0.025	0.04	0.08	0.4	0.4	0.4	1	1	1
12.5	0.025	0.04	0.09	0.42	0.42	0.42	1.05	1.05	1.05
16	0.025	0.04	0.1	0.45	0.45	0.45	1.1	1.1	1.1
20	0.025	0.04	0.11	0.48	0.48	0.48	1.2	1.2	1.2
25	0.025	0.04	0.125	0.50	0.5	0.5	1.25	1.25	1.25
32	0.025	0.04	0.14	0.53	0.53	0.53	1.3	1.3	1.3
40	0.025	0.04	0.16	0.56	0.8	1.1	1.4	1.6	1.8
50	0.025	0.04	0.18	0.6	0.85	1.2	1.5	1.7	1.9
63	0.04	0.063	0.2	0.63	0.9	1.25	1.6	1.8	2
80	0.063	0.1	0.22	0.67	0.95	1.3	1.7	1.9	2.1
100	0.1	0.16	0.25	0.71	1	1.4	1.8	2	2.2
125	0.16	0.25	0.28	0.75	1.05	1.5	1.9	2.1	2.4
160	0.25	0.4	0.32	0.8	1.1	1.6	2	2.2	2.5
200	0.4	0.63	0.42	1	1.4	2	2.5	2.8	3.2
250	0.56	1	0.56	1.25	1.8	2.5	3.2	3.6	4
320	0.75	1.6	0.75	1.6	2.2	3.2	4	4.5	5
400	1	2	1	2	2.8	4	5	5.6	6.3
500	1.3	2.5	1.3	2.5	3.6	5	6.3	7.1	8 (7.9) ⁴⁾
630	1.8	3.2	1.8	3.2	4.5	6.3	8 (7.9) ⁴⁾	9 (8.4) ⁴⁾	10 (9) ⁴⁾
800	2.4	4	2.4	4	5.6	8	10 (9) ⁴⁾	11 (9.6) ⁴⁾	12.5 (10.2) ⁴⁾
1000	3.2	5	3.2	5	7.1	10	12.5 (10.2) ⁴⁾	14 (11.2) ⁴⁾	16 (12.8) ⁴⁾
1250			4.2	6.3	9	12.5	16 (12.8) ⁴⁾	18 (14.4) ⁴⁾	20 (16) ⁴⁾
1600			5.6	8	11	16	20 (16) ⁴⁾	22 (17.6) ⁴⁾	25 (20) ⁴⁾
2000			7.5	10	14	20	25 (20) ⁴⁾	28 (22.4) ⁴⁾	32 (25.6) ⁴⁾
2500			10	12.5	18	25	32 (25.6) ⁴⁾	36 (28.8) ⁴⁾	40 (32) ⁴⁾
3200			12.5	16	22	32	40 (32) ⁴⁾	45 (36) ⁴⁾	50 (40) ⁴⁾
4000			16	20	28	40	50 (40) ⁴⁾	56 (44.8) ⁴⁾	63 (50.4) ⁴⁾
5000			20	25	36	50	63 (50.4) ⁴⁾	71 (56.8) ⁴⁾	80 (64) ⁴⁾
6300			25	32	45	63	80 (64) ⁴⁾	90 (72) ⁴⁾	100 (80) ⁴⁾
8000			32	40	56	80	100 (80) ⁴⁾	110 (88) ⁴⁾	125 (100) ⁴⁾
10000			40	50	71	100	125 (100) ⁴⁾	140 (112) ⁴⁾	160 (128) ⁴⁾
12500			50 ³⁾	63 ³⁾	90 ³⁾	125 ³⁾			
16000			63 ³⁾	80 ³⁾	110 ³⁾	160 ³⁾			
20000			80 ³⁾	100 ³⁾	140 ³⁾	200 ³⁾			
25000			100 ³⁾	125 ³⁾	180 ³⁾	250 ³⁾			
32000			125 ³⁾	160 ³⁾	220 ³⁾	320 ³⁾			
40000			160 ³⁾	200 ³⁾	280 ³⁾	400 ³⁾			
50000			200 ³⁾	250 ³⁾	360 ³⁾	500 ³⁾			
63000			250 ³⁾	320 ³⁾	450 ³⁾	600 ³⁾			

¹⁾ This voltage is for:

- Functional insulation; the working voltage
- Basic and supplementary insulation of the circuit energized directly from the mains (see 4.3.2.2.1): for the voltage rationalized through Table F.3a or F.3b, based on the rated voltage of the equipment, or the rated insulation voltage
- Basic and supplementary insulation of systems, equipment and internal circuits not energized directly from the mains (see 4.3.2.2.2): the highest rms voltage which can occur in the system, equipment or internal circuit when supplied at rated voltage and under the most taxing combination of operation conditions within equipment rating

²⁾ Material group IIIb is not recommended for applications in pollution degree 3 above 630 V.

³⁾ Provisional data based on extrapolation. Technical committees who have other information based on experience may use their dimensions.

⁴⁾ The values in brackets must only be applied for reducing creepage distances if a rib is used (see 5.2.5).

The high degree of accuracy of the creepage distances given in the table does not imply that the measuring accuracy must be of the same quality.

Depending on the intended use, WAGO's terminal blocks, splicing and pluggable connectors are suitable for pollution degrees 2 or 3 and for overvoltage categories II or III.

Example:

WAGO Rail-Mount Through Terminal Blocks
per IEC 60947-7-1/
EN 60947-7-1/VDE 0611-1, these blocks have the following ratings:

800 V / 8 kV / 3

Rated voltage:	800 V
Rated surge voltage	8 kV
Pollution Degree	3
Overvoltage category	III

WAGO's connectors for household and similar mounted installations are rated per IEC 60998-1 / EN 60998-1 / VDE 0613-1, Table 3.

Example:

WAGO PUSH WIRE® Connectors for Junction Boxes

According to this standard, these connectors are rated for:

*400 V / 4 kV / 2

*grounded circuits

Rated voltage:	400 V
Rated surge voltage	4 kV
Pollution Degree	2
Overvoltage category	II

Table 3 – Clearances and Creepage Distances
(IEC/EN 60998-1)

Rated Insulation Voltage V	Clearances/Creepage Distances mm
≤ 130	1.5
> 130 and ≤ 250	3
> 250 and ≤ 450	4
> 450 and ≤ 750	6
> 750	8

Tests and Testing Procedures per IEC/EN Standards (continued)

Electrical Tests (continued)

• Power-Frequency Withstand Voltage Test per IEC/EN 60947-7-1, IEC/EN 60947-1

This testing procedure verifies creepage distances. Creepage distances, i.e., the distances of creeping currents, are caused by conductive impurities on the surface of the insulation housing. Apart from the amount of impurities to which a terminal block is subjected, for example, the plastic material and housing design are also involved in generating creeping currents. The insulation material of the housing may be carbonized by a creeping current, which further increases conductivity.

The specimen is tested using a power-frequency withstand voltage for a short time. For example, a rail-mount terminal block designed to operate at 800 V nominal voltage is usually tested using 2000 V alternating voltage for one minute. The test is passed if no flashovers or breakdowns have occurred.

• Rated Impulse Withstand Voltage Test per IEC/EN 60947-7-1, IEC/EN 60947-1

This test verifies the clearances of a product. In simplified terms, clearance is the distance between two poles of a terminal block. If this distance is too small, voltage peaks may cause flashovers or breakdowns. The arrangement of the rated impulse withstand voltage test is identical to that of the power frequency withstand voltage test; the test voltages, however, are comparatively higher and the testing times shorter, e.g., 9.8 kV over 50 µs (see figure).

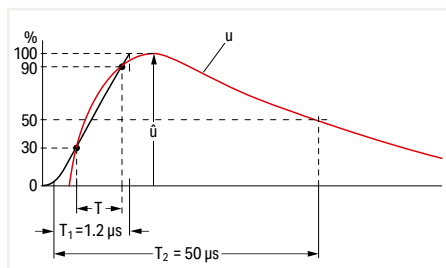

Voltage pulse: measurement curve (red) and auxiliary curve (black) for calculating the rate of rise of the pulse and the resulting (virtual) peak of the curve.

- T: Time interval for calculating the rate of rise
- T1: Front time (duration between start of impulse and reaching the peak)
- T2: Total pulse duration

The test values are the values at sea level as specified in the relevant test specification. The values indicated in the catalog correspond to an altitude of 2000 m. The test is passed if no flashovers or breakdowns have occurred.

Voltage pulse: 1.2/50 µs per EN 60060-1/VDE 0432-1

• IP Ratings for Electrical Equipment per IEC/EN 60529

Alphanumeric Nomenclature for Type of Protection			IP vs. NEMA		
Code letters IP	Protection against accidental contact and against the penetration of foreign objects or water	IP (Ingress Protection) = International degree of protection		IP Code	NEMA
First code number 0 to 6	Indicates the degree of protection against accidental contact and the penetration of foreign objects.	If indicating the degree of protection requires only one digit, the other (second) digit must be substituted for with an X.		10	1
Second code number 0 to 8	Indicates the degree of protection against water penetration.			11	2
First code number:		Second code number:		54	3
IP0X	No protection against accidental contact or the penetration of foreign objects	IPX0	No protection against water	14	3R
IP1X	Protection against foreign objects > 50 mm	IPX1	Protection against vertically falling water	54	3S
IP2X	Protection against foreign objects > 12 mm (e.g., finger)	IPX2	Protection against diagonally dripping water (15° angle)	55	4&4X
IP3X	Protection against foreign objects > 2.5 mm	IPX3	Protection against water spray	52	5
IP4X	Protection against foreign objects > 1 mm	IPX4	Protection against water spray	67	6&6P
IP5X	Protection against damaging dust deposits	IPX5	Protection against water jet, e.g., from a nozzle	52	12&12K
IP6X	Protection against dust penetration	IPX6	Protection against flooding	54	13
		IPX7	Protection against temporary immersion		
		IPX8	Protection against continuous immersion		
		IPX9	Protection against high-pressure and high-temperature water jets		

Tests and Testing Procedures per IEC/EN Standards (continued)

Material Tests

All WAGO products meet requirements for the following material tests:

- Needle Flame Test per IEC/EN 60947-7-1, IEC/EN 60695-11-5

This test simulates flames that may arise under certain conditions (e.g. fault current over a creepage distance, overloading of parts or components). Nearby parts can also be affected by such flames.

Not only the ignition of the test specimen resulting from an intrinsic defect is tested, but also its behavior when other parts ignite.

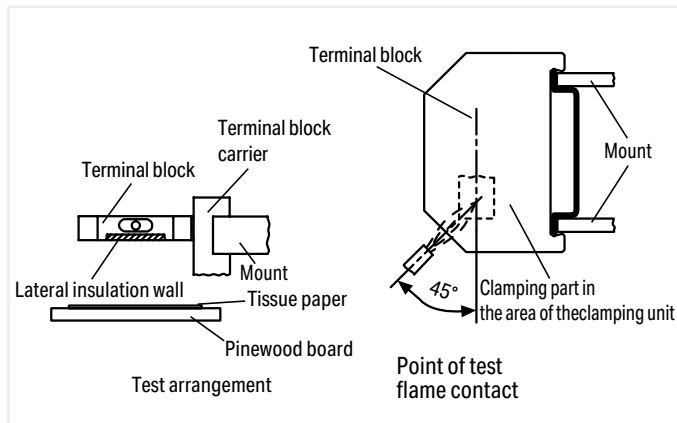

Flames must not be fuelled by the insulation materials used, thus creating a larger fire. The test specimen is exposed to a standard gas flame during a defined time period (e.g., ten seconds).

After the test flame has been removed, the specimen must self-extinguish within 30 seconds. Furthermore, a layer of tissue paper located beneath the specimen must not be ignited by glowing particles falling from the specimen.

- Glow-Wire Test per IEC/EN 60998-1, IEC/EN 60695-2-11

In the event of failure, a high current may cause a conductor to glow.

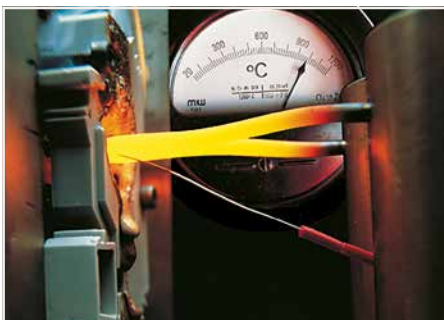

However, the glowing conductor shall not cause ignition of the product involved (e.g., a rail-mount terminal block). For the glow-wire test, the tip of the glow-wire is pressed against a surface of the test specimen (see picture).

The position of the test specimen, surface to be tested, test duration and glow-wire temperature (e.g., 960°C/1760°F over 30 seconds, or 850°C/1562°F over 5 seconds) are specified in the standards.

The specimen must be positioned such that the tip of the glow-wire acts on the surface section of the specimen (vertical surface of the specimen) that is most likely to be exposed to thermal loading during normal use.

As the highest temperature in the event of a fault is anticipated at the contact insert/wire connection, the tip of the glow-wire must act upon the section of the insulation housing that is the closest to this contact point.

The test is passed if there are no visible flames or permanent glowing, or if flames or glowing extinguish within 30 seconds after removal of the glow-wire. Furthermore, a layer of tissue paper located beneath the specimen must not be ignited by glowing particles falling from the specimen.

Tests and Testing Procedures per IEC/EN Standards (continued)

Environmental Tests

The following tests show how a product reacts when exposed to an aggressive environment. Climatic chambers simulate standard atmospheres that could impact the long-term consistency of clamping units.

All WAGO products meet the requirements of the following environmental tests:

- Temperature Cycling Test per IEC/EN 60947-7-1, IEC/EN 60998-2-2

This test shows the change of voltage drop over longer periods under temperature cycling conditions. The test procedure usually consists of 192 temperature cycles, for example, each cycle having a duration of 60 minutes (see diagram).

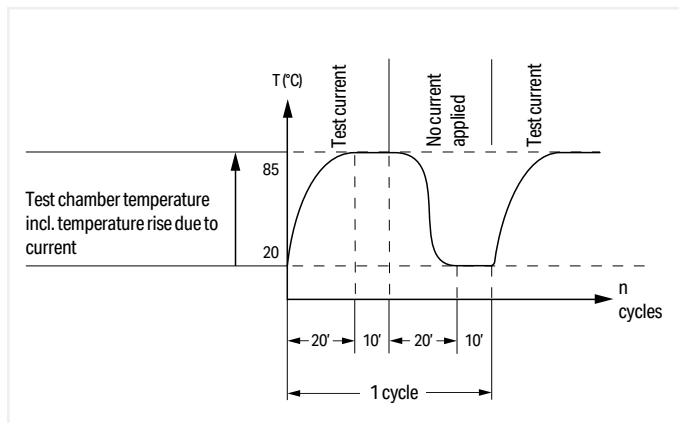

The rated current is applied to the test specimen during temperature rise and when the temperature has reached its maximum value; during the second half of the cycle, the current is zero. Voltage drop is measured every 24 cycles and must not exceed a maximum value or vary greatly. The voltage drop measured at the end of the 192nd cycle must not exceed 1.5 times the value measured after the 24th cycle. After the test, an inspection must show no changes that would impair further use of the product.

- Industrial Atmospheres per EN ISO 6988, IEC/EN 60068-2-42, IEC/EN 60068-2-60

Sulphur and its combustion products are particularly aggressive pollutants commonly found in industrial environments. A test procedure simulating such corrosive conditions consists of exposing a test specimen to water condensation in variable atmospheres containing sulphur dioxide.



A saturated atmosphere is first created in a climatic chamber by heating an aqueous sulphur dioxide solution. After less than half an hour, the test specimen is fully saturated by the condensing vapors and exposed to this atmosphere for eight hours.

After exposure to a humid atmosphere, the test specimen is subjected to dry and cooler conditions at room temperature for 16 hours. Depending on the test severity, the specimen is exposed to both these conditions several times. The gas-tightness of the clamping unit is verified by a voltage drop test.

In other test procedures, products are exposed to a dry corrosive gas atmosphere containing sulfide, nitrogen and sulfur oxides or chloride gas. These tests can be performed over a period of four to 21 days.

• Salt Spray Test per IEC/EN 60068-2-11; DNV GL, LR (Marine Applications)

This test is similar to the test performed in atmospheres with varying water condensation, except that instead of industrial atmospheres, salt mist conditions will be simulated in a heated test chamber (see picture).

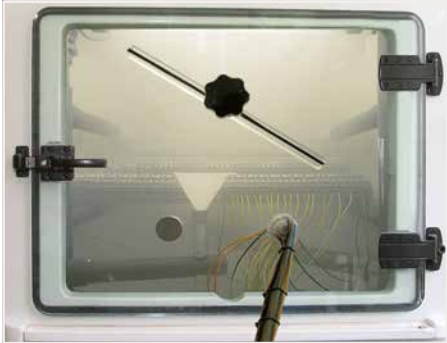

Depending on the test procedure being used, the test specimen is sprayed with salt mist for 16 hours up to 672 hours (4 weeks).

Salt spray tests are widely used, especially for marine approvals.

However, this test is performed differently than the test procedures described previously for general applications:

During a typical test, the test specimen is sprayed with a salt solution for two hours and is then stored for seven days in an atmosphere with a relative humidity between 90 and 95%. This procedure is repeated four times.

Voltage drop measurements are used as an evaluation criterion.

• Quick Change of Temperature per IEC/EN 60068-2-14

Without air-conditioning, distribution panels and terminal boxes are exposed to seasonal (and ever-changing) temperature extremes – especially on the open field side.

In process technology, for example, a terminal block is exposed to even quicker changes in temperature.

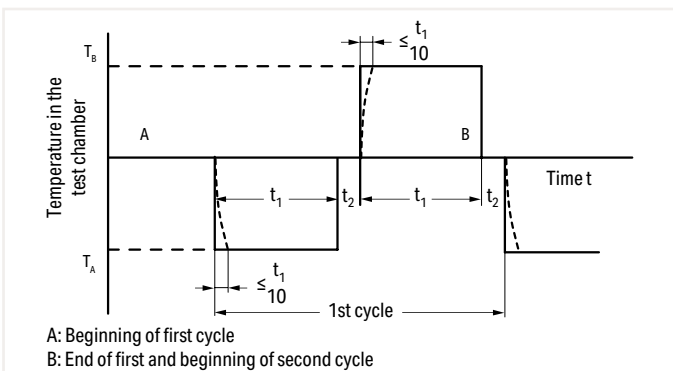

To simulate such conditions, the test specimen is exposed to repeated temperature changes, for example, between $T_A -40^{\circ}\text{C}$ (-104°F) and $T_B +70^{\circ}\text{C}$ ($+158^{\circ}\text{F}$).

The dwell time t_1 depends on the thermal capacity of the test specimen and should be between maximum of 3 h and minimum of 10 min and the transition time $t_2 \dots 3 \text{ min}, 20 \dots 30 \text{ s}$ or less than 10 s.

The mechanical and electrical properties of the product are checked at the end of the test.

• Damp Heat, Cyclic (12 + 12 Hour Cycle) per IEC/EN 60068-2-30, DNV GL, LR (Marine Applications)

This test determines the suitability of electrical equipment for use and storage under conditions of high relative humidity when combined with cyclic temperature changes and, in general, producing condensation on the surface of the specimen.

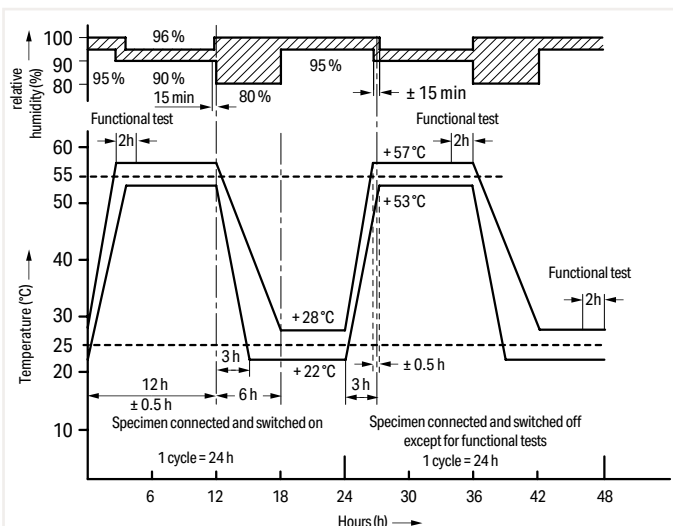

In addition to the salt spray tests, the damp heat test is also used for marine approvals.

For this test, the specimens are subjected to temperatures varying cyclically between $+25^{\circ}\text{C}$ ($+77^{\circ}\text{F}$) and $+55^{\circ}\text{C}$ ($+131^{\circ}\text{F}$) with a relative humidity of 95% (for tolerances see figure).

Functional tests are performed at defined times during the storage period.

The mechanical and electrical properties of the product are checked at the end of the test.

UL Specifications – Underwriters Laboratories, USA

WAGO's terminal blocks and connectors are tested by Underwriters Laboratories Inc. according to one or more of the relevant following UL standards:

- | | | |
|---|--------------------|---|
| <ul style="list-style-type: none"> • The 273 Series PUSH WIRE® Connectors for Junction Boxes or the 224 Series Lighting Connectors are splicing wire connectors and are certified per UL 486C. These stand-alone devices carry the UL Listing Mark ®. | UL 486C | Splicing wire connectors |
| <ul style="list-style-type: none"> • Rail-mount terminal blocks or modular terminal blocks (e.g., 280 Series, TOPJOB® S or 260 to 262 Series terminal blocks) are approved as non-stand-alone components per UL 1059 in connection with UL 486E. | UL 1059
UL 486E | Standard for terminal blocks
Equipment wiring terminals for use with aluminum and/or copper conductors |
| <ul style="list-style-type: none"> • The X-COM®-SYSTEM is approved as terminal blocks per UL 1059 standard in connection with UL 486E. It is therefore defined for field and factory wiring with at 300 V. | | |
| <ul style="list-style-type: none"> • It is also approved as connectors for use in data, signal, control and power applications per UL 1977 for factory wiring at 600 V (i.e., the clamping unit must be wired under controlled manufacturing conditions). | UL 1977 | Component connectors for use in data, signal, control and power applications |
| <ul style="list-style-type: none"> • Ex e II terminal blocks are approved to UL 60079-7. | UL 60079-7 | Electrical apparatus for explosive gas atmospheres – Part 7: Increased safety |
| <ul style="list-style-type: none"> • Ground terminal blocks are tested for grounding and bonding applications per UL 467. Components bearing the UR Recognition Mark ® are recognized product. Additionally, after being mounted in their special applications, these components are submitted to an end-product test according to the relevant device or equipment standard. | UL 467 | Grounding and bonding equipment |
| <ul style="list-style-type: none"> • Insulation materials are tested for flammability and performance per UL 94. | UL 94 | Tests for flammability of plastic materials for parts in devices and appliances |

Tests and Testing Procedures per UL Standards

All WAGO products meet requirements for the following tests:

- Pull-Out Test per UL 1059, UL 486E (Rail-Mount Terminal Blocks), UL 486C (Splicing Wire Connectors)

In this test, the connected conductors are subjected to the appropriate pull-out forces specified in the following table without jerking for a period of one minute. Different test arrangements are specified for rail-mount terminal blocks and splicing wire connectors.

Conductor Size AWG or kcmil		Pull-Out Force, Pounds (N)					
		UL 486E, Table 22				UL 486C, Table 20	
		Copper		Aluminum		Copper	
	(mm ²)		(N)		(N)		(N)
30	(0.05)	0.5	(2.2)	-	-	1.5	(6.7)
28	(0.08)	1	(4.5)	-	-	2	(8.9)
26	(0.13)	2	(8.9)	-	-	3	(13.4)
24	(0.2)	3	(13.4)	-	-	5	(22.3)
22	(0.32)	4.5	(20)	-	-	8	(35.6)
20	(0.52)	6.75	(30)	-	-	10	(44.5)
18	(0.82)	6.75	(30)	-	-	10	(44.5)
16	(1.3)	9	(40)	-	-	15	(66.7)
14	(2.1)	11.5	(50)	-	-	25	(111)
12	(3.3)	13.5	(60)	10	(44)	35	(155)
10	(5.3)	18	(80)	10	(44)	40	(178)
8	(8.4)	20.5	(90)	10	(44)	45	(200)
6	(13.3)	21	(94)	28	(124)	50	(222)
4	(21.2)	30	(133)	36	(160)		
3	(26.7)	35	(156)	42	(187)		
2	(33.6)	42	(186)	50	(222)		
1	(42.4)	53	(236)	61	(271)		
1/0	(53.5)	64	(285)	72	(320)		
2/0	(67.4)	64	(285)	78	(347)		
3/0	(85.0)	79	(351)	97	(432)		
4/0	(107)	96	(427)	116	(516)		
250	(127)	96	(427)	116	(516)		
300	(156)	99	(441)	116	(516)		

Test Arrangement per UL 1059, UL 486E:

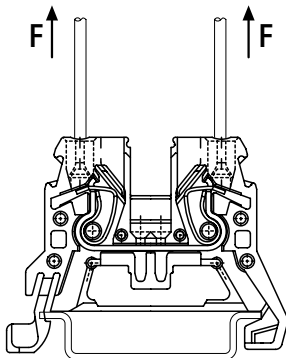

Test Arrangement per UL 486C:

During the test, the conductors must neither slip out of the clamping unit, nor break near the clamping unit.

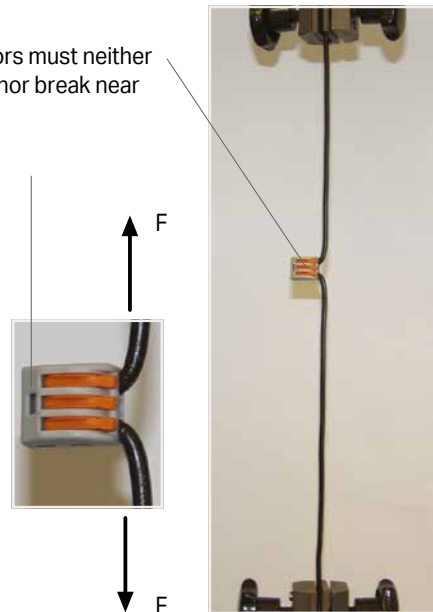

UL Specifications – Underwriters Laboratories, USA (continued)

Tests and Testing Procedures per UL Standards (continued)

• Heat Cycling Test per UL 1059, UL 486E

Test performed per:

UL 1059

Test performed with maximum rated cross section

Test current: 150% of maximum rated current

84 cycles of: 3 1/2 h ON / 1/2 h OFF

The temperature rise is measured after the first and the 84th cycle.

The temperature rise must not exceed 5°C (41°F) after the 84th cycle, compared to the temperature measured after the first cycle.

UL 486C (Splicing wire connectors)

UL 486E (Equipment wiring terminals)

Test performed with maximum rated cross section

Test current: Increased test current per UL 486C, Table 6
UL 486E, Table 4

500 cycles of: 1 h ON / 1 h OFF
1 1/2 h ON / 1 1/2 h OFF
(from 4/0 AWG up to 400 kcmil per UL 486E)

The temperature rises at the terminal blocks and control conductors are measured and recorded after: 1, 25, 50, 75, 100, 125, 175, 225, 275, 350, 425 and 500 cycles.

The temperature rise must not exceed 125°C (257°F) and the stability factor "S" must not exceed ±10.

Conductor Size		Test Current for Copper Conductors in A								
		UL 486E, Table 4						UL 486C, Table 6		
		Assigned Maximum Ampere Rating ^b	Static Heating ^{a,c,g}	Heat Cycling Temperature Rating ^a			Static Heating	Heat Cycling		
75°C (167°F) ^{d,g}	90°C (194°F) ^{e,g}									
AWG or kcmil	(mm ²)									
30	(0.05)	-		3		3.5		4	3	3.5
28	(0.08)	-		3.5		4		5	3.5	4
26	(0.13)	-		5.5		6		8	5.5	6
24	(0.2)	-		7		8		10	7	8
22	(0.32)	-		9		12		13	9	12
20	(0.52)	-		12		16		17	12	16
18	(0.82)	-		17		19		24	17	19
16	(1.3)	-		18		20		31	18	20
14	(2.1)	15	[20]	30	[22]	33	[27]	40	30	33
12	(3.3)	20	[25]	35	[28]	39	[40]	54	35	38
10	(5.3)	30	[40]	50	[45]	56	[60]	75	50	56
8	(8.4)	50		70		80		100	70	80
6	(13.3)	65		95		105		131	95	105
4	(21.2)	85		125		140		175		
3	(26.7)	100		145		165		205		
2	(33.6)	115		170		190		240		
1	(42.4)	130		195		220		275		
1/0	(53.5)	150		230		255		320		
2/0	(67.4)	175		265		300		370		
3/0	(85.0)	200		310		345		435		
4/0	(107)	230		360		405		505		
250	(127)	255		405		445		565		
300	(152)	285		445		500		625		

^a See Section 7.2, 8.2 and 9.2 (UL 486E)

^b Values are for 75°C (167°F), not more than 3 conductors in raceway or cable ampacities, National Electric Code, ANSI/NFPA 70.

^c Values are for 75°C (167°F) single conductors in free air ampacities, National Electric Code, ANSI/NFPA 70.

^d Values are approximately 112% of the static heating test currents.

^e Values for 8 AWG and larger conductors are approximately 140% of the static heating test currents.

^f See Section 9.2.4

^g Values in parentheses apply to connectors with assigned ampere ratings.

• Conditioning – Temperature-Rise Rest per UL 1059, UL 486C

Test performed per:

UL 1059 (Rail-mount terminal blocks)

UL 486C

(Splicing wire connectors)

Conditioning:

The clamping units are **pre-wired/pre-inserted nine times** using a conductor with maximum rated cross section. At the tenth time, a new conductor is connected.

After this, a static heating test is performed.

Static Heating Test:

Test current: Terminal block rated current

Test current: Increased test current (see Table 6)

Test duration: 30 days

Test duration: 30 days

Max. permissible temperature rise: 30°C (86°F)

Max. permissible temperature rise: 50°C (122°F)

• Grounding and Bonding Equipment per UL 467

When used in grounding and bonding equipment, e.g., terminal blocks, must withstand a short circuit test using the test currents and test durations as specified in Table 5.

In the following example, a 2 AWG (35 mm²) ground conductor terminal block (285-635) is tested for 6 seconds at 3900 A.

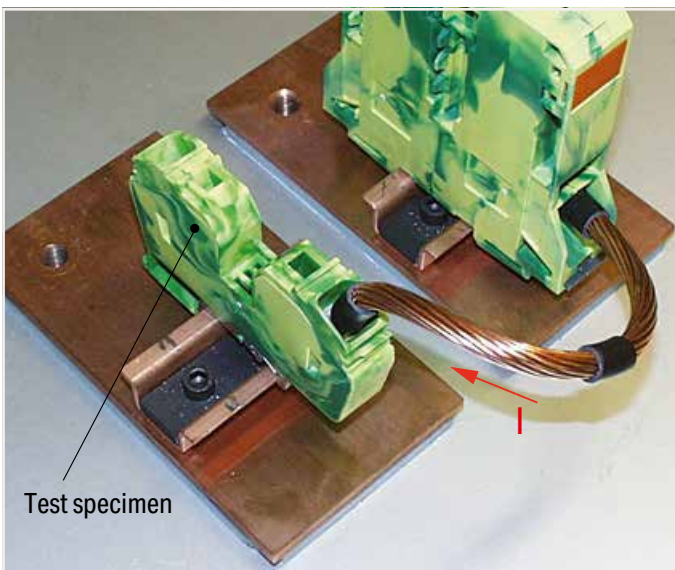

Table 5

Conductor Size Copper		Test Duration	Test Current
AWG	mm ²	s	A
14	(2.1)	4	300
12	(3.3)	4	470
10	(5.3)	4	750
8	(8.4)	4	1180
6	(13.3)	6	1530
4	(21.2)	6	2450
3	(26.7)	6	3100
2	(33.6)	6	3900
1	(42.4)	6	4900
1/0	(53.5)	9	5050
2/0	(67.4)	9	6400
3/0	(85.0)	9	8030
4/0	(107)	9	10100
250 kcmil	(127)	9	12000

After the test, the specimen must neither show evidence of cracking, breaking or melting, nor any changes in electrical properties.

UL Specifications – Underwriters Laboratories, USA (continued)

Tests and Testing Procedures per UL Standards (continued)

• Insulation Parameters per UL 1059

The table below shows the potential involved and the corresponding clearances and creepage distances required in different applications.

Table 8.1 – Minimum Acceptable Spacing for Terminal Blocks per UL 1059 Standard

Application:	Potential Involved in Volts	Spacing in inches (mm) between uninsulated live parts of opposite polarity, uninsulated live parts and uninsulated grounded parts other than the enclosure			
		Through Air		Over Surfaces	
A. Dead-front switchboards, panelboards, service equipment and similar applications	51 ... 150 151 ... 300 301 ... 600	1/2 (12.7) 3/4 (19.1) 1 (25.4)	3/4 (19.1) 1-1/4 (31.8) 2 (50.8)		
B. Commercial appliances, including business equipment, electronic data processing equipment and similar applications	51 ... 150 151 ... 300 301 ... 600	1/16 ^a (1.6) ^a 3/32 ^a (2.4) ^a 3/8 (9.5)	1/16 ^a (1.6) ^a 3/32 ^a (2.4) ^a 1/2 (12.7)		
C. Industrial, general	51 ... 150 151 ... 300 301 ... 600	1/8 ^a (3.2) ^a 1/4 (6.4) 3/8 (9.5)	1/4 (6.4) 3/8 (9.5) 1/2 (12.7)		
D. Industrial, devices having limited ratings ^b	51 ... 300 301 ... 600	1/16 ^a (1.6) ^a 3/16 ^a (4.8) ^a	1/8 ^a (3.2) ^a 3/8 (9.5)		
E. Terminal blocks rated 601 ... 1500 V ^c	601 ... 1000 1001 ... 1500	0.55 (14.0) 0.70 (17.8)	0.85 (21.6) 1.20 (30.5)		

Notes:

- 1 A slot, groove, or similar, 0.013 inch (0.33 mm) wide or less in the contour of the insulating material is to be disregarded.
- 2 Air space of 0.33 mm or less between a live part and an insulating surface is to be disregarded for the purpose of measuring over surface spacing.
- ^a The spacing between terminal blocks of opposite polarity and the spacing between a terminal block and a grounded dead metal part shall not be less than 1/4 inch (6.4 mm) if short-circuiting or grounding of such terminal blocks may result from protruding wire strands.
- ^b See Section 8.5 (UL 1059)
The spacing values indicated in sub-paragraph D in Table 8.1 are applicable to a terminal block for use only in or with industrial control equipment where the load on any single circuit of the terminal block does not exceed 15 A at 51 ... 150 V, 10 A at 151 ... 300 V, 5 A at 301 ... 600 V or the maximum ampere rating, whichever is less.
- ^c Applies only to terminal blocks investigated to Part II of this standard. See Section 22.1 (UL 1059).

• Flammability Test per UL 94

This test provides an indication of the material's ability to extinguish a flame, once ignited. Several ratings can be applied, based on the rated of burning, time to extinguish, ability to resist dripping, and afterglow extinguishing time. Each material tested may receive several ratings, depending on the wall thickness.

UL 94 Rating Categories:

V2

- Specimen mounted vertically
- Burning stops within 30 seconds after the flame is removed
- Flaming drips allowed
- Afterglow extinguishes within max. 60 s

V1

- Specimen mounted vertically
- Burning stops within 30 seconds after the flame is removed
- No flaming drips allowed
- Afterglow extinguishes within max. 60 s

V0

- Specimen mounted vertically
- Burning stops within 10 seconds after the flame is removed
- No flaming drips allowed
- Afterglow extinguishes within max. 30 s

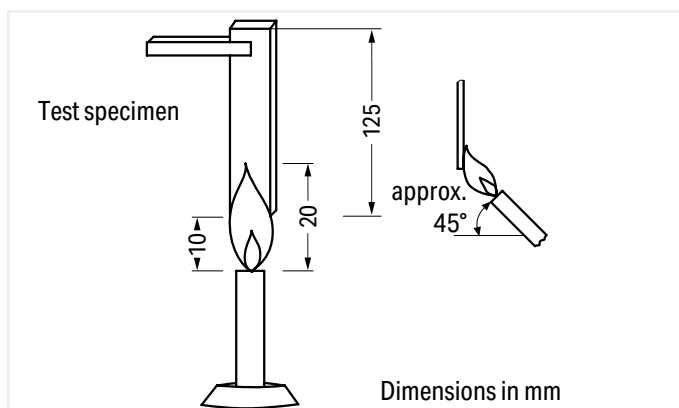

During the test, a 3/4 inch (20 ± 1 mm) flame is applied for two 10-second intervals to the specified bar specimen held vertically.

"Alu-Plus" Contact Paste

Terminating aluminum conductors

Terminating Aluminum Conductors

WAGO spring clamp terminal blocks are suitable for solid aluminum conductors ① up to 4 mm²/12 AWG if WAGO "Alu-Plus" Contact Paste is used for termination.

"Alu-Plus" Contact Paste Advantages:

- Automatically destroys the oxide film during clamping.
- Prevents fresh oxidation at the clamping point.
- Prevents electrolytic corrosion between aluminum and copper conductors (in the same terminal block).
- Provides long-term protection against corrosion.

Using terminal blocks with CAGE CLAMP® Spring Pressure Connection Technology, **aluminum conductors must first be cleaned with a blade** and then immediately be inserted into the clamping units filled with "Alu-Plus" Contact Paste.

It is also possible to apply WAGO "Alu-Plus" **additionally** on the whole surface of the aluminum conductor before termination.

Please note that the nominal currents must be adapted to the reduced conductivity of the aluminum conductors:

$$\begin{aligned} 2.5 \text{ mm}^2 \text{ (14 AWG)} &= 16 \text{ A} \\ 4 \text{ mm}^2 \text{ (12 AWG)} &= 22 \text{ A} \end{aligned}$$

WAGO "Alu-Plus" in the syringe offers a higher degree of reliability and cleanliness when terminating solid aluminum conductors. Filling is quickly performed on selected WAGO connectors and terminal blocks (see pictures).

① Aluminum conductors per IEC 61545 standard, Class B, "Alloy 1370" with 90 ... 180 N/mm² tensile strength and 1 ... 4% elongation
Standard values: 90 ... 180 MPa tensile strength, 1 ... 4% elongation (per EN 615.4.1)



WAGO Lighting Connectors

Push nozzle of the "Alu-Plus" syringe first into the circular entry and then into the square conductor entry hole of the WAGO Lighting Connector.



Press plunger down until the "Alu-Plus" has filled both entry holes.

Note: Not suitable for higher temperature applications!



WAGO Rail-Mount Terminal Blocks (up to 4 mm²/12 AWG)

For each conductor entry: Insert nozzle of the "Alu-Plus" syringe in every open conductor entry hole (one after the other).



Press plunger down until "Alu-Plus" has filled all conductor entry holes.

Material Specifications

Insulation materials

WAGO primarily uses polyamide (PA 66 and PA 46) for housing current-conducting parts, as well as polyphthalamide (PPA) and polycarbonate (PC) for insulation material (see table). For more than 50 years, these materials have proven themselves in WAGO products and all are approved by certified, third-party agencies. All listed halogen-free and flame-retardant polymer materials do not contain any heavy metals, silicone, asbestos, or formaldehyde as formulation components.

Table: Standard Insulation Materials

Material	PA 66	PA 66 GF	PPA GF	PA 46	PC	PC
Flammability UL 94 flammability test ratings	V0	V0	V0	V2	V2	V0
Oxygen Index (OI) per EN ISO 4589-2	> 32 %	> 33 %	> 37 %	> 27 %	> 26 %	> 35 %
Glow-wire test per IEC 60695-2-12 GWFI* IEC 60695-2-13 GWIT*	850°C 775°C	850°C 775°C	850°C 775°C	750°C 725°C	800°C 850°C	960°C 850°C
Comparative Tracking Index (CTI) per IEC 60112	600 V	600 V	600 V	375 V	225 V	225 V
Temperature of the ball indentation hardness test per IEC 60695-10-2	≥ 125 °C	≥ 175 °C	≥ 225 °C	n.s.**	≥ 125 °C	≥ 125 °C
RTI impact per UL 746B	105°C	100°C	115°C	115°C	125°C	120°C
Heat deflection temperature (HDT/B) per ISO 75 (bending stress A*: 1.8 MPa; B: 0.45 MPa)	215°C	235°C	285°C	280°C	130°C (1.8 MPa)	130°C (1.8 MPa)
Surface resistivity per IEC 60093	10 ¹² Ω	10 ¹² Ω	10 ¹⁵ Ω	10 ¹³ Ω	10 ¹⁵ Ω	10 ¹⁵ Ω
Specific contact resistance per IEC 60093	10 ¹⁵ Ω/cm	10 ¹⁵ Ω/cm	10 ¹³ Ω/cm	10 ¹³ Ω/cm	10 ¹¹ Ω/cm	10 ¹³ Ω/cm
Dielectric strength per IEC 60243-1	30 kV/mm	40 kV/mm	25 kV/mm	25 kV/mm	25 kV/mm	29 kV/mm

*Value depends on wall thickness, EN 60335 compliance upon request; **n. s. = not specified

General Environmental Requirements for WAGO Electrical Interconnection Products

WAGO Electrical Interconnection Products are designed for worldwide applications.

To properly commission products, the following environmental requirements must be observed during storage, transportation and operation.

Table 1: General Environmental Requirements for Storage, Transportation and Operation*

Environmental requirements during	Value range
Operation	-35 °C ... +60 °C
Storage and transportation	-40 °C ... +60 °C
Relative humidity (storage and transportation)	20 % ... 95 % (non-condensing, no dew)

*These requirements apply to open and packaged products unless otherwise specified on the product at www.wago.com or on the catalog page.

Polyamide (PA 66)

WAGO uses modified, halogen-free, flame-retardant polyamides.

These materials do not corrode, are difficult to ignite and feature self-extinguishing properties (V0 rating per UL 94).

Adhering to UL 746C, the polyamides used at WAGO have a continuous operating temperature of 105°C (221°F) based on the relative temperature index with impact load (RTIimp). This ensures that the necessary electrical and mechanical insulating properties are maintained at a sufficiently guaranteed level over a long period of time.

The short-term upper temperature limit is 200°C (392°F).

In lower temperature ranges, it has been determined that no damage to the insulation material occurs during usage down to -35°C (-31°F). After installation and wiring, WAGO products can even be used at temperatures down to -60°C (-76°F).

Environmental humidity (up to 2.5% in a standard atmosphere) is absorbed, providing the polyamides with optimum elasticity, strength and durability.

In practical use, basic stabilization of WAGO's polyamides has been proven over many years to be sufficient to prevent damage caused by ozone or UV radiation exposure in intended applications.

Polyamides have excellent resilience against the most demanding climates and have proven themselves in tropical applications worldwide. Insulation parts made of polyamide are resistant to insects. The material does not provide oxygen or other biogenic elements to microorganisms.

The presence of anaerobic earth bacteria, mold, fungus and enzymes does not degrade the material.

Polyamides are resistant to most fuels, greases, and oils, as well as the most commonly used cleaners, such as alcohol, Freon, Frigen, and carbon tetrachloride. Acid resistance depends on the acid type and concentration, as well as the exposure time.

The use of insulation materials during in-house production at WAGO only occurs after acceptance of factory test certificates and specified material tests.

Glass Fiber-Reinforced Polyamide (PA 66 GF)

WAGO uses glass-fiber-reinforced polyamides for components with increased mechanical demands, such as levers, push-buttons or housings exposed to high stress, because they have significantly better mechanical characteristic properties than non-reinforced polyamides.

In general, materials are used that have excellent tracking resistance, flammability ratings and high temperature resistance.

More data can be found in the table.

Polyphthalamide (PPA GF)

Glass-fiber-reinforced, high-performance polyamides are ideal for high-temperature applications, due to the material's high level of thermal dimensional stability, its low dependence on ambient conditions and its excellent strength properties. The material's outstanding tracking resistance permits short creepage distances to be incorporated into miniature components. Fire protection equipment enables classification in flammability class V0 per UL 94 – even for extremely thin walls. PPA GF absorbs minute amounts of moisture from the atmosphere making it ideal for reflow soldering applications and for thin-walled, dimensionally stable components.

More data can be found in the table.

Polyamide (PA 46)

In comparison with PA 66, PA 46 has substantially higher dimensional stability under heat. The relative temperature index with impact load (RTIimp) is 115°C (239°F) for PA 4.6.

The permissible short-term temperature for the type used by WAGO is 280°C (536°F).

More data can be found in the table.

Polycarbonate (PC)

Polycarbonate has excellent dimensional stability under heat. The electrical and mechanical properties remain intact at extremely high temperatures up to approximately 120°C (248°F) per UL Yellow Card. Its excellent electrical insulating properties and dimensional stability are virtually independent of environmental conditions, such as humidity and temperature. Highly precise components can be created due to the low shrinkage of the material during injection molding. Polycarbonate has excellent weather resistance and is also highly resistant to high energy radiation. If the PC is not colored, then the components are glass-clear.

Thanks to its desirable properties (e.g., dimensional stability, heat resistance, non-flammability, durability and transparency), PC is a proven and widely used material in the electrical industry.

Depending on the demands placed on the finished product, WAGO uses polycarbonates that carry flammability classifications V2 and V0 per UL 94.

Medium-viscosity PC is used that features excellent chemical resistance.

Material Specifications

Contact Materials

Hard and extra-hard electrolytic copper (ECu), as well as extra-hard copper alloys are the standard materials used for the current-carrying parts of all WAGO products.

These materials combine excellent conductivity and good chemical resistance without the risk of stress-induced cracking.

Contact Materials

The special tin layer, which is the standard layer for all current-carrying parts in WAGO products, ensures perfect long-term protection against corrosive substances. Furthermore, these layers provide a gas-tight contact that ensures a durable transition resistance.

At the clamping unit, the conductor is embedded into the soft tin layer via high contact pressure. This protects the contact area against corrosion.

The thick tin layer also ensures good solderability of both PCB terminal block and connector solder pins.

Clamping Spring Material

Every WAGO clamping spring is made of high-quality, accurately tested austenitic chrome nickel steel (CrNi) with high tensile strength, which boasts proven corrosion resistance through long-term usage.

It is resistant to sea spray, city pollutants and industrial emissions (e.g., sulfur dioxide, hydrogen sulfide).

At room temperatures of approximately 20°C (68°F), the material is resistant to salt solutions up to 30% and dilute phosphoric acids up to 30%.

Even after decades of use, no galvanic corrosion between the chrome nickel spring steel (in connection with the contact materials used by WAGO) and the connected copper conductors has been detected.

The relaxation of the material as a function of time and surrounding temperatures up to 105°C (221°F) can be ignored. Samples loaded with 500 N/mm² at a temperature of 250°C (482°F) showed a relaxation of only 1.5%.

In certain product lines, the clamping springs are thermally treated at temperatures between 350°C (662°F) and 420°C (788°F) after production.

This treatment reduces internal stress due to the material's mechanical deformation, which may result in a slight brown discoloration of the spring surface.

WAGO only accepts deliveries of chrome nickel spring steel against certificates of conformity and after select material tests have been performed.

General Technical Information on Electrical Equipment Used in Hazardous Areas

The formation of an explosive atmosphere is required for the existence of a potentially explosive hazard. Such an atmosphere can be produced at any location where flammable gases or liquids are manufactured, processed, transported and/or stored.

Such hazardous areas can be found in a wide range of industries, including chemical plants, refineries, power plants, paint production facilities, painting shops, filling stations, vehicles, sewage treatment plants, airports, grain mills or harbor facilities.

THE FOLLOWING APPLIES AS A GUIDELINE FOR THE UNDERLYING PRINCIPLE FOR EXPLOSION PROTECTION:

General Requirements

The European EN 60079-0 Standard – VDE 0170-1 Classification – contains general requirements for the design and testing of electrical equipment to be used in hazardous areas.

This ensures this equipment does not cause an explosion in the surrounding atmosphere. EN 60079-0 is supplemented or revised by the European standards indicated on the right which refer to the specifically standardized types of protection.

Electrical Equipment

Electrical equipment includes all items used in whole or in part with electricity. This includes items for generation, transport, distribution, storage, measurement, control, conversion and consumption of electrical power, as well as telecommunications.

Ex Components

Ex components are elements of electrical equipment for hazardous areas that are marked with the "U" letter. These components must not be used on their own in such areas and require an additional certificate when used in such areas when installed in the electrical equipment.

Ignition Protection Categories

Only explosion-proof (protected) equipment must be used in areas in which an explosive atmosphere may still be expected despite the implementation of prevention measures. Explosion-protected electrical equipment can have various types of protection in accordance with the EN 60079 standard requirements.

Protection used by the manufacturer essentially depends on the type and function of the apparatus. From a safety point of view, all standardized types of protection should be viewed as equal.

The ignition protection category "n" exclusively describes the use of explosion-protected electrical components in Zone 2. This zone includes areas in which hazardous, potentially explosive atmospheres are likely to occur rarely or short-term. This represents a transition between Zone 1, in which explosion protection is required, and the safe area in which, for example, welding may be performed at any time.

Regulations covering these electrical components are being prepared worldwide. Organizations such as KEMA in the Netherlands, or PTB in Germany certify that the devices meet the requirements of the EN 60079-15 standard.

Ignition protection category "n" also requires that electrical equipment be provided with additional ID markings as follows:

- nA – non-sparking
- nC – enclosed-break, hermetically sealed, non-incendive, sealed
- nR – restricted-breathing

The table on the opposite page shows an overview of the standardized ignition protection categories and describes their basic principle, as well as typical applications.

General Technical Information on Electrical Equipment Used in Hazardous Areas Continued

Ignition Protection Categories			
Symbol	Standard	Explanation	Application Area
"o"	IEC 60079-6 EN 60079-6	Equipment protection by oil immersion: Electrical equipment or parts of such equipment are immersed in oil.	Zones 1 + 2
"p"	IEC 60079-2 EN 60079-2	Equipment protection by pressurized enclosure: The ingress of the external (explosive) atmosphere into the electrical equipment housing is prevented by maintaining a protective gas internally at a pressure above that of the external atmosphere.	Zones 1 + 2
"q"	IEC 60079-5 EN 60079-5	Equipment protection by sand filling: Filling the electrical equipment housing with fine grain sand prevents the ignition of a surrounding explosive atmosphere by an electric arc generated in the housing.	Zones 1 + 2
"d"	IEC 60079-1 EN 60079-1	Equipment protection by flameproof enclosures: The parts that could ignite an explosive atmosphere are encapsulated in a housing, which will withstand the explosion pressure within the housing.	Zones 1 + 2
"eb" "ec"	IEC 60079-7 EN 60079-7	Equipment protection by increased safety: Additional measures applied to achieve increased security against the possibility of excessive temperatures and the occurrence of arcs or sparks.	Zones 1 + 2
"i"	IEC 60079-11 EN 60079-11	Equipment protection by intrinsic safety: Power circuit in which no sparks or thermal effects can occur and cause the ignition of a certain explosive atmosphere.	Zones 1 + 2 following special testing Zone 0
"nA" "nC" "nR"	IEC 60079-15 EN 60079-15	Equipment protection by type of protection "n": Electrical equipment of group II for use in areas in which an explosive mixture of gas, vapor or mist is unlikely to occur during normal operation and, if it does, will be for a short period.	Zone 2:
"m"	IEC 60079-18 EN 60079-18	Equipment protection by cast encapsulation: Dangerous electrical equipment is embedded in a cast mass. This corresponds approximately to the known special Ex s protection type.	Zones 1 + 2
	IEC 60079-25 EN 60079-25	Intrinsically safe electrical systems "i": Assembly of interconnected electrical equipment in which the circuits intended for use, as a whole or in part, in hazardous environments are intrinsically safe. It is documented accordingly in the system description	Zones 1 + 2 following special testing Zone 0

Hazardous Areas

Hazardous areas are zones in which the atmosphere may become explosive. An explosive atmosphere is a mixture of flammable substances in the form of gases, vapors or mixtures with air under atmospheric conditions in critically mixed ratios such that excessive high temperature, arcs or sparks may cause an explosion.

EN 60079-10-1/EN 60079-10-2 and all other well-known standards rank hazardous areas according to the likelihood of the occurrence of an explosive atmosphere into the following zones:

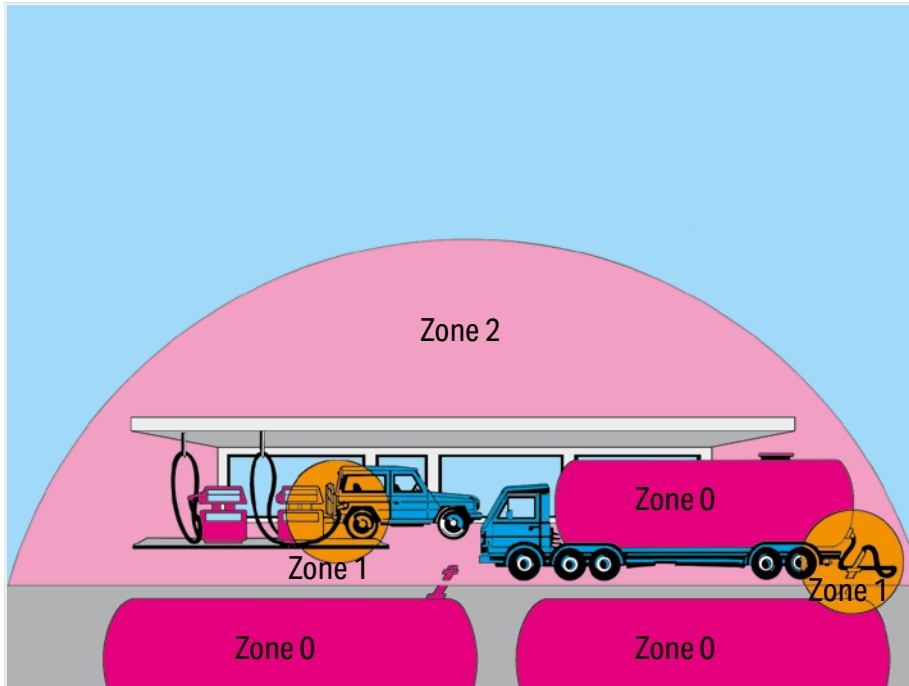

Hazardous areas due to explosive gases, vapors and mists:

Zone 0

Area in which an explosive gas atmosphere is present continuously, for long periods or frequently.

Zone 1

Area in which an explosive gas atmosphere is likely to occur periodically or occasionally during normal operation.

Zone 2:

Area in which an explosive gas atmosphere is unlikely to occur during normal operation; if it does occur, then it is temporarily.

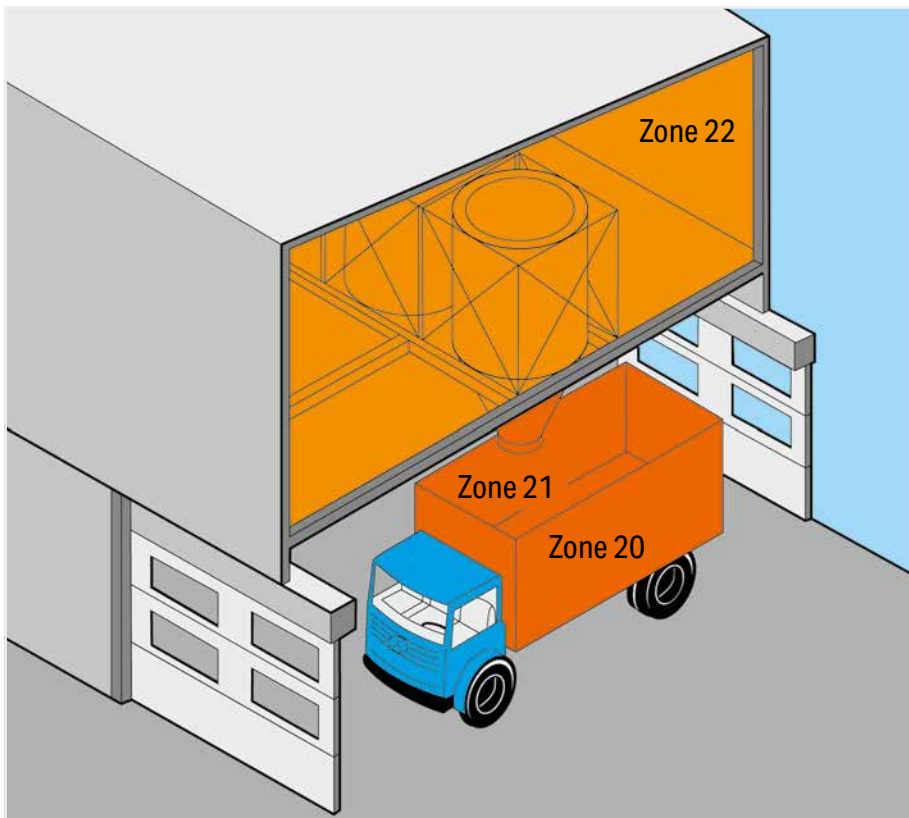

Hazardous areas due to explosive dust/air mixtures:

Zone 20

Area in which an explosive dust atmosphere due to dust/air mixtures is present continuously, for long periods or frequently.

Zone 21

Area in which an explosive dust atmosphere due to dust/air mixtures is likely to occur occasionally during normal operation.

Zone 22

Area in which an explosive dust atmosphere due to flammable dust/air mixtures is unlikely to occur during normal operation; but if it occurs, then only for a short period of time.

General Technical Information on Electrical Equipment Used in Hazardous Areas

Continued

EN 60079-0 also classifies electrical equipment for use in hazardous areas into two groups:

Group I:

Electrical equipment for mines susceptible to firedamp

Group II:

Electrical equipment for hazardous areas, except for mines susceptible to firedamp.

As this broad application range encompasses a large number of potentially flammable gases, Group II is broken down into sub-groups IIA, IIB and IIC.

This breakdown is based on different gases/materials exhibiting differing ignition power levels as parameters. Therefore, representative gases have been allocated to these three sub-groups:

- IIA – Propane
- IIB – Ethylene
- IIC – Hydrogen

WAGO's terminal blocks can be used both in Group I and Group II.

This information is given under Item 12 in the EU Prototype Test Certificates, based on which the terminal blocks have been approved for Group I and Group II.

Temperature Class	Maximum Surface Temperature (°C)
T1	450
T2	300
T3	200
T4	135
T5	100
T6	85

Depending on the maximum surface temperature, electrical equipment in Group II are classified in temperature categories T1 to T6 for all protection types. The surrounding air temperature, which must be accounted for in dimensioning, is defined as 40°C/104°F (deviations are acceptable under some conditions).

Terminal blocks for "eb" (increased safety) protection type are generally assigned to temperature category T 6. When rail-mount terminal blocks are used in equipment of temperature categories T1 to T5, ensure that the highest temperature on the insulating parts does not exceed 85°C (185°F). The highest measured surface temperature rise must not exceed 40 K.

Thermal resistance of the insulation material must be at least 20°C (68°F) greater than the highest operating temperature. Low temperature stability is considered to be sufficient when the insulation material can withstand 24-hour storage at a temperature of -60°C (-76°F) without nullifying the type of protection.

Special Requirements "Increased Safety Ex e"

The European EN 60079-7 Standard – VDE 0170-6 Classification – contains special requirements for the design and testing of electrical equipment with "eb" (increased safety) protection type for use in hazardous areas.

This standard is a supplement to EN 60079-0 and applies to equipment or parts thereof that neither generate sparks or arcing under normal operating conditions, nor exhibit hazardous temperatures.

This standard describes special measures, which have to be observed to obtain a safety degree according to the "eb" (increased safety) protection type.

Ex components such as rail-mount terminal blocks are covered by Section 4.2 "Terminal Blocks for External Conductors":

- The terminal blocks must be installed in an enclosure meeting the requirements of a recognized protection type per EN 60079-0, Section 1 or EN 60079-31.
- When installing the terminal blocks in an enclosure of protection type "eb" (increased safety) per EN 60079-7, the clearances and creepage distances of Table 2 must be observed. When using accessories, the installation instructions of the manufacturer must be observed.
- The terminal blocks can be used both in Group II and Group I, as the standard requirements are identical in this case.
- The use of this component requires a new assessment by a notified certification agency.

Minimum Ignition Power of Typical Gases:

Explosion Group	I	IIA	IIB	IIC
Gas	Methane	Propane	Ethylene	Hydrogen
Ignition Power	280	250	82	16

The following are the most important design requirements for terminal blocks for external supply conductors to electrical equipment: These must:

- be sufficiently large to permit reliable connection of external supply conductors with cross section of at least the size required by the nominal current of the equipment
- be protected against self-loosening and designed such that the supply conductors cannot slip out of their clamping units
- be designed such that adequate contact pressure is ensured without damaging the conductors
- be designed such that their contact pres-

sure does not change with temperature cycling

- be equipped with a spring connecting link for the connection of stranded conductors
- be designed so as to allow secure connection of smaller conductors for terminal blocks up to 4 mm² (12 AWG).

Classification of insulation materials according to their tracking resistance is based on their Comparative Tracking Index (CTI) and is defined in Table 1 as follows:

This classification applies to insulating parts without ribs or grooves.

If the insulating parts have ribs or grooves sufficiently large to be considered, the minimum creepage distances must be set according to values for the insulation materials in the next-higher level (e.g., Group I, instead of Group II).

Accounting for the surrounding air temperature of 40°C (104°F) specified for electrical equipment, the current-carrying capacity of rubber-insulated conductors is reduced to 82%, based on DIN VDE 0298-4:2013-06, Table 12 and to 87% for PVC-insulated conductors for the current-carrying capacity defined for 30°C (86°F) in accordance with DIN VDE 0298-4:2013-06, Item 4.3.3.

Conductor Types and Conductor Preparation

In accordance with EN 60079-14/DIN VDE 0165-1, the ends of stranded and fine-stranded conductors must be protected against splaying (e.g., via cable lugs or ferrules) or by the type of terminal blocks used. Soldering alone is not sufficient.

According to EN 60069-7/DIN VDE 0170-6, connecting electrical equipment to terminal blocks having an "eb" (increased safety) protection type must not lead to a reduction of the clearances and creepage distances.

Based on experience through the application of terminal blocks in aggressive atmospheres in the chemical industry, WAGO recommends gas-tight tinned copper ferrules or tinned copper pin terminals when connecting fine-stranded conductors to terminal blocks in

Table 1– Tracking Resistance for Insulation Materials

Material Group	Comparative Tracking Index
I	600 ≤ CTI
II	400 ≤ CTI < 600
III a	175 ≤ CTI < 400
III b	100 ≤ CTI < 175

corrosive atmospheres.

Table 2– Minimum Creepage Distances/Clearances and Isolations

Voltage (see ^a and ^b) RMS Value for AC or DC Voltage V	Minimum Creepage Distance mm								Minimum Clearance and Isolations mm		
	Material Group								Clearance mm	Distance under Coat- ing ^d	Distance under Coat- ing ^d
	I		II		III a		III b				
	"eb"	"ec"	"eb"	"ec"	"eb"	"ec"	"eb"	"ec"	"eb"	"ec"	"ec"
≤ 10 (see ^c)	1.6	1	1.6	1	1.6	1	-	1	1.6	0.4	0.3
≤ 12.5	1.6	1.05	1.6	1.05	1.6	1.05	-	1.05	1.6	0.4	0.3
≤ 16	1.6	1.1	1.6	1.1	1.6	1.1	-	1.1	1.6	0.8	0.3
≤ 20	1.6	1.2	1.6	1.2	1.6	1.2	-	1.2	1.6	0.8	0.3
≤ 25	1.7	1.25	1.7	1.25	1.7	1.25	-	1.25	1.7	0.8	0.3
≤ 32	1.8	1.3	1.8	1.3	1.8	1.3	-	1.3	1.8	0.8	0.3
≤ 40	1.9	1.4	2.4	1.6	3	1.8	-	1.8	1.9	0.8	0.6
≤ 50	2.1	1.5	2.6	1.7	3.4	1.9	-	1.9	2.1	0.8	0.6
≤ 63	2.1	1.6	2.6	1.8	3.4	2	-	2	2.1	0.8	0.6
≤ 80	2.2	1.7	2.8	1.9	3.6	2.1	-	2.1	2.2	0.8	0.8
≤ 100	2.4	1.8	3	2	3.8	2.2	-	2.2	2.4	0.8	0.8
≤ 125	2.5	1.9	3.2	2.1	4	2.4	-	2.4	2.5	1	0.8
≤ 160	3.2	2	4	2.2	5	2.5	-	2.5	3.2	1.5	1.1
≤ 200	4	2.5	5	2.8	6.3	3.2	-	3.2	4	2	1.7
≤ 250	5	3.2	6.3	3.6	8	4	-	4	5	2.5	1.7
≤ 320	6.3	4	8	4.5	10	5	-	5	6	3	2.4
≤ 400	8	5	10	5.6	12.5	6.3	-	6.3	6	4	2.4
≤ 500	10	6.3	12.5	7.1	16	8	-	8	8	5	2.4
≤ 630	12	8	16	9	20	10	-	10	10	5.5	2.9
≤ 800	16	10	20	11	25	12.5	-	-	12	7	4
≤ 1000	20	11	25	11	32	13	-	-	14	8	5.8
≤ 1250	22	12	26	12	32	15	-	-	18	10	-
≤ 1600	23	13	27	13	32	17	-	-	20	12	-
≤ 2000	25	14	28	14	32	20	-	-	23	14	-
≤ 2500	32	18	36	18	40	25	-	-	29	18	-
≤ 3200	40	22	45	22	50	32	-	-	36	22	-
≤ 4000	50	28	56	28	63	40	-	-	44	28	-
≤ 5000	63	36	71	36	80	50	-	-	50	36	-
≤ 6300	80	45	90	45	100	63	-	-	60	45	-
≤ 8000	100	56	110	56	125	80	-	-	80	56	-
≤ 10000	125	71	140	71	160	100	-	-	100	70	-
≤ 12500	-	90	-	90	-	125	-	-	-	89	-
≤ 13640	-	98	-	98	-	138	-	-	-	97	-

^{a)} When determining the required values for creepage distances and clearances, the working voltage may be 1.1 times higher than the value in the table.

NOTE: The factor of 1.1 takes into account that in many places in a circuit the working voltage is equal to the rated voltage and that a number of rated voltages are used, which are covered by a factor of 1.1.

^{b)} The specified values for creepage distances and clearances already take into account a 10% tolerance for the highest supply voltage. Therefore, further considerations on the voltage fluctuations are unnecessary for determining which voltage value from the table should be used.

^{c)} CTI values are not applicable for voltages of 10 V or less. Materials that do not meet the requirements of material group III a can be used.

^{d)} The specified distances under consideration apply to printed circuit boards in protection level "ec" after 4.5.

It is expressly prohibited to use insulating parts for transferring contact forces. Terminal blocks with sharp edges which could damage supply lines and those types that can be rotated, turned or permanently deformed when fixed in place are not permitted for use. Terminal blocks for internal connections in electrical equipment must not be subjected to excessive mechanical stress. These items must fulfill the requirements for terminal blocks used for external supply conductors.

Clearances between conductive parts having different potentials must be at least 3 mm for external connections, as specified in Table 2. The value of the creepage distances depends on the working voltage, surface geometry of the insulating parts and tracking resistance of the insulation material.

Grooves on the surface may only be considered if they are at least 2.5 mm deep and wide; ribs on the surface only if their height is at least 2.5 mm and their width corresponds to the mechanical strength of the material, however not smaller than 1 mm.

General Technical Information on Electrical Equipment Used in Hazardous Areas Continued

Approvals

Terminal blocks may be used in Zones 1 and 2, provided that the terminal blocks are accommodated in an enclosure that has a minimum IP54 protection and an Ex e certification.

Terminal blocks are considered to be Ex components because they are a part of the equipment. Part certificates provided by Ex Certification Agencies serve as a basis for issuing the complete conformity declaration for the unit.

An EC-type examination certificate is issued in accordance with the 2014/34/EU ATEX Directive.

In addition, an IEXEx Certificate may also be obtained from an appropriate, recognized certification agency in accordance with the IECEx Certification Agreement that is accepted throughout Europe and also in countries such as Canada, China and Australia.

These certificates can also be viewed at: www.iecex.com.

Terminal block marking per 2014/34/EU ATEX Directive:

	Ⓜ	II	2	G	Ex eb IIC	Gb
Explosion prevention marking						
Group II (for equipment used in areas in which an explosive atmosphere might occur)						
Category 2 (high safety, equipment used in areas [zones] in which a potentially explosive atmosphere occurs only occasionally. Explosion protection must continue to be provided even in the event of frequent device faults.)						
Gases						
Explosion protection in Europe, "increased safety" protection type, Group II						
Level of equipment protection (Device with "high" protection level for use in areas where there is a potential risk of explosion where there is no risk of ignition resulting from predictable or faults/malfunctions.)						
or						
Explosion prevention marking		I	M 2	Ex eb I	Mb	
Group I (for equipment used in underground applications)						
Mining applications						
Explosion protection in Europe, "increased safety" protection type, Group I						
Level of equipment protection (Device with "high" protection level for installing in mines that are susceptible to firedamp, that guarantee the required measure of safety, where there is no risk of ignition resulting from predictable faults/malfunctions during normal operation in the time between the gas escaping and switching off the device.)						

Example of marking (rear):

Series

Manufacturer's name

Nominal isolation voltage

Protection type

Part certification no.

Nominal cross section
(solid, stranded or fine-stranded conductors)

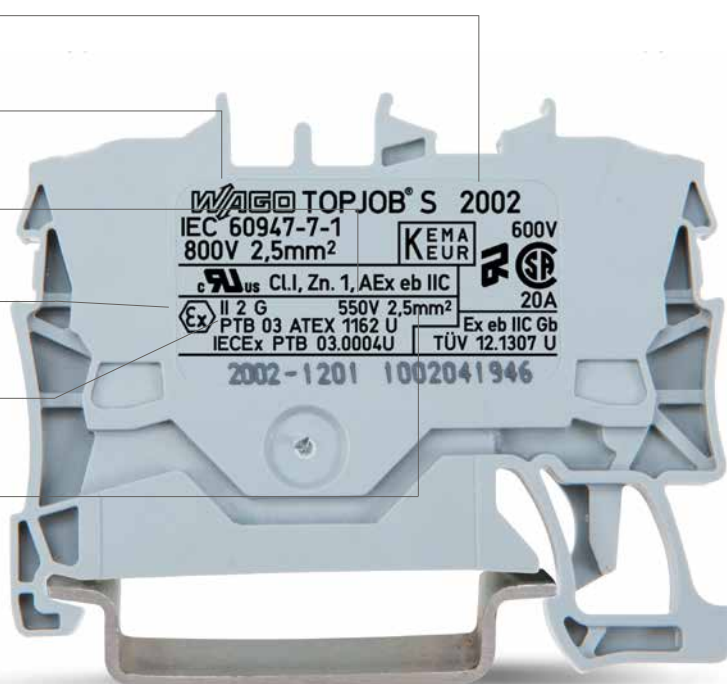

The embossed details on the terminal blocks show the manufacturer's name, the series number, the approval number, the approval data and the name of the testing authority. The type of protection Ex eb IIC Gb shown on the label or on the smallest packaging unit.

Terminal blocks for Class I, Zone 1, Ex eb IIC hazardous locations can be approved for Ex applications per UL 60079-7 standard. As a result of international harmonization efforts, the UL certificate can be issued on the basis of EN 60079-0 or EN 60079-7 standards, provided that the terminal blocks have also been approved per UL 1059 (ordinary location).

If desired by the applicant, terminal blocks can simultaneously be approved in accordance with the Canadian Standards CAN/CSA-C22.2 No. 60079-0 and CAN/CSA C22.2 No. 60079-7 and released for use in Canada. The terminal blocks are marked with  Cl. I, Zn. 1, AEx eb IIC.

EU-type examination certificates have been granted to all WAGO terminal blocks listed in this catalog. WAGO terminal blocks approved for use in Ex eb IIC areas are manufactured of flame-resistant, self-extinguishing Polyamide 66. The same applies to the terminal blocks used in non-hazardous areas. Tracking resistance with a CTI value of 600 as per IEC 60112 and a constant operating temperature of 105°C (22°F) in accordance with IEC 60216-1 and -2 are provided. Factory part quality tests are performed on all CAGE CLAMP® rail-mount terminal blocks with Ex eb IIC approval to monitor and ensure the quality features described above.



IECEX Certificate of Conformity

INTERNATIONAL ELECTROTECHNICAL COMMISSION
IEC Certification Scheme for Explosive Atmospheres

for rules and details of the IECEX Scheme visit www.iecex.com

Ex COMPONENT CERTIFICATE

Certificate No.: IECEX PTB 18.0012U	Issue No: 0	Certificate history: Issue No. 0 (2018-08-30)
Status: Current	Page 1 of 3	
Date of Issue: 2018-08-30		
Applicant: WAGO Kontakttechnik GmbH & Co. KG Hansastraße 27 32423 Minden Germany		
Ex Component: WAGO type PE & Through terminal blocks type TOPJOB S 2202-**** and TOPJOB S 2202-***7		

This component is NOT intended to be used alone and requires additional consideration when incorporated into other equipment or systems for use in explosive atmospheres (refer to IEC 60079-0).

Type of Protection: **Increased Safety "eb"**

Marking: Ex eb IIC Gb and Ex eb I Mb

Approved for issue on behalf of the IECEX Certification Body:

Position:

Signature: (for printed version)

Date:

Dipl.-Phys. U. Völkel

Department "Explosion Protection in Energy Technology"



31.8.18

1. This certificate and schedule may only be reproduced in full.
2. This certificate is not transferable and remains the property of the issuing body.
3. The Status and authenticity of this certificate may be verified by visiting the Official IECEX Website.

Certificate issued by:

Physikalisch-Technische Bundesanstalt (PTB)
Bundesallee 100
38116 Braunschweig
Germany



Physikalisch-Technische Bundesanstalt
Braunschweig und Berlin





EU-Baumusterprüfbescheinigung

- (1) Komponente zur bestimmungsgemäßen Verwendung in explosionsgefährdeten Bereichen
Richtlinie 2014/34/EU
- (3) EU-Baumusterprüfbescheinigungsnummer
PTB 18 ATEX 1005 U Ausgabe: 0
- (4) Produkt: Durchgangsreihenklemmen Typ TOPJOB S 2202-****
Schutzleiterreihenklemmen Typ TOPJOB S 2202-***7
- (5) Hersteller: WAGO Kontakttechnik GmbH & Co. KG
- (6) Anschrift: Hansastraße 27, 32423 Minden, Deutschland
- (7) Die Bauart dieses Produkts sowie die verschiedenen zulässigen Ausführungen sind in der Anlage und den darin aufgeführten Unterlagen zu dieser Baumusterprüfbescheinigung festgelegt.
- (8) Die Physikalisch-Technische Bundesanstalt, notifizierte Stelle Nr. 0102 gemäß Artikel 17 der Richtlinie 2014/34/EU des Europäischen Parlaments und des Rates vom 26. Februar 2014, bescheinigt, dass dieses Produkt die grundlegenden Sicherheits- und Gesundheitsanforderungen für die Konzeption und den Bau von Produkten zur bestimmungsgemäßen Verwendung in explosionsgefährdeten Bereichen gemäß Anhang II der Richtlinie erfüllt.
Die Ergebnisse der Prüfung sind in dem vertraulichen Prüfbericht PTB Ex 18-17171 festgehalten.
- (9) Die grundlegenden Sicherheits- und Gesundheitsanforderungen werden erfüllt durch Übereinstimmung mit
IEC 60079-0:2017, EN 60079-7:2015
- (10) Das Zeichen "U" hinter der Zertifikatsnummer gibt an, dass dieses Zertifikat nicht mit einem für ein Gerät oder Schutzsystem vorgesehenen Zertifikat verwechselt werden darf. Diese Komponenten-Bescheinigung darf als Basis für die Bescheinigung eines Gerätes oder Schutzsystems verwendet werden.
- (11) Diese EU-Baumusterprüfbescheinigung bezieht sich nur auf Konzeption und Prüfung des festgelegten Produkts gemäß Richtlinie 2014/34/EU. Weitere Anforderungen dieser Richtlinie gelten für die Herstellung und das Bereitstellen auf dem Markt. Diese Anforderungen werden nicht durch diese Bescheinigung abgedeckt.
- (12) Die Kennzeichnung des Produkts muss die folgenden Angaben enthalten:

 **II 2 G Ex eb IIC Gb bzw. IM 2 Ex eb I Mb**

Konformitätsbewertungsstelle, Sektor Explosionsschutz Braunschweig, 30. August 2018
Im Auftrag



Dipl.-Phys. U. Völkel

Seite 1/3

EU-Baumusterprüfbescheinigungen ohne Unterschrift und ohne Siegel haben keine Gültigkeit.
Diese EU-Baumusterprüfbescheinigung darf nur unverändert weiterverbreitet werden.
Auszüge oder Änderungen bedürfen der Genehmigung der Physikalisch-Technischen Bundesanstalt.
Physikalisch-Technische Bundesanstalt • Bundesallee 100 • 38116 Braunschweig • DEUTSCHLAND

General Technical Information on Electrical Equipment Used in Hazardous Areas

Continued

Special Requirements

Equipment Protection by Intrinsic Safety "i"
The European EN 60079-11 Standard – Classification VDE 0170-7 – contains special requirements for the design and testing of electrical equipment with "i" (intrinsic safety) protection type for use in hazardous areas.

A circuit is "intrinsically safe" when, under normal operating conditions and in the event of specific fault conditions, no sparks or thermal effects can occur and cause the ignition of a certain explosive atmosphere.

A distinction is made here between:

- intrinsically safe electrical equipment when all circuits are intrinsically safe
- associated electrical equipment including both intrinsically and non-intrinsically safe circuits, and being designed such that the non-intrinsically safe circuits cannot affect the intrinsically safe ones.

Intrinsically safe electrical equipment and intrinsically safe parts of associated electrical equipment are classified at "ia", "ib" or "ic" protection level.

Electrical equipment classified Ex "ia" must not ignite when current is applied in the following cases:

- During fault-free operation, with those non-discreet faults present that result in the most adverse condition
- During fault-free operation and with a discreet fault, plus those non-discreet faults that result in unfavorable conditions
- During fault-free operation with two discreet faults, plus those non-discreet faults that result in the most adverse conditions.

Electrical equipment classified Ex "ib" must not ignite when current is applied in the following cases:

- During fault-free operation, with those non-discreet faults present that result in the most adverse condition
- During fault-free operation and with a discreet fault, plus those non-discreet faults that result in unfavorable conditions.

At applied voltages, the intrinsically safe circuits in electrical equipment of protection level "ic" shall not be capable of causing ignition during undisturbed operation and under the conditions specified in this standard. No special approval is required for terminal blocks used as simple electrical equipment for "Ex i" protection type, as they do not contain a voltage source and precise information is available concerning electrical data and temperature rise performance.

The terminal blocks must be identifiable, for example by their type designation, and the following design requirements must also be upheld:

Clearances and creepage distances between bare conductive parts of terminal blocks of separate intrinsically safe circuits and grounded or floating conductive parts shall be equal to or greater than the values given in Table 5 (see 672). If separate intrinsically safe circuits are to be considered, the air gap between bare conductive parts of the outer connection parts must meet the following requirements:

- at least 6 mm between the separate intrinsically safe circuits
- at least 3 mm from grounded parts, if a possible connection to ground has not been considered in the safety analysis. Each possible motion of metallic parts that are not rigidly secured must be considered.

Terminal block marking must be unique and clearly visible. If a color is used for this, the color must be light blue (similar to RAL 5015).

Note also when using terminal blocks:

Terminal blocks used for intrinsically safe circuits must be isolated from those used in non-intrinsically safe circuits. This is accomplished by several accepted methods. First, intrinsically safe circuits are separated by at least 50 mm of air space from non-intrinsically safe circuits.

Second, intrinsically safe circuits are housed in a separate enclosure. Third, intrinsically safe terminal blocks are separated from non-intrinsically safe terminal blocks by either an insulated partition or grounded metal partition. The partition size must allow for either 1.5 mm or less distance from the sides of the housing or provide at least 50 mm of creepage distance between the intrinsically and non-intrinsically safe circuits in all directions.

The insulation between an intrinsically safe and a non-intrinsically safe circuit has to withstand an effective AC voltage of 2 x nominal value (U) 1000 V or a minimum of 1500 kV, whereby U represents the total of the effective voltages of the intrinsically safe and the non-intrinsically safe circuit.

Short circuit between different intrinsically safe circuits could cause dangerous conditions. The insulation between these circuits should withstand an effective voltage of at least 500 VAC or 2 UAC where U is the total of the effective voltages of the related circuits.

In accordance with EN 60079-14/ DIN VDE 0165-1, in intrinsically safe circuits, the ends of stranded and fine-stranded conductors must be protected against splaying (e.g., via cable lugs or ferrules) or by the type of terminal blocks used. Soldering alone is not sufficient.

WAGO recommends gas-tight tinned copper ferrules or tinned copper pin terminals when connecting fine-stranded conductors to terminal blocks in corrosive atmospheres.

Requirements pertaining to the necessary distances as appropriate for use of the terminal blocks in the area DIN EN 60079-11 (VDE 0170-7) "Explosive atmosphere – Part 11: Device protection by intrinsically safe features "i" (IEC 60079-11)" are defined under Section 6.2 "Connecting point for external circuits," Section 6.2.1 "Terminal blocks." In general, the following can be stated for terminal blocks based on figure 1: "Example of isolated intrinsically safe terminal blocks with partition" in conjunction with figure 2: "Example of isolation of conductive parts," considering Table 5 – "Clearances, Creepage and Isolation Distances."

Outside:

a) Isolated intrinsically safe circuits: at least 6 mm

All PCB terminal blocks listed on the ordering pages as suitable for Ex "i" applications fulfill these requirements.

b) Intrinsically safe circuits and normal circuits (non-intrinsically safe): ≥ 50 mm

Inside:

a) Ex "i" to Ex "i"

b) Ex "i" to normal circuits

c) Ex "i" to ground

Based on Figure 2 and Table 5 (see next page) in accordance with the selected protection level and the special requirements for isolation distances as described in Sections 6.3.1 to 6.3.13, or in accordance with the alternative procedure for dimensioning of isolation distances given in Annex F.

Terminal blocks with smaller pin spacing may also be used for internal connections, provided they meet the requirements laid out in Table 5 (see below).

The exact clearances and creepage distances as well as separation distances based on Table 5 must be derived from the application items cited above.

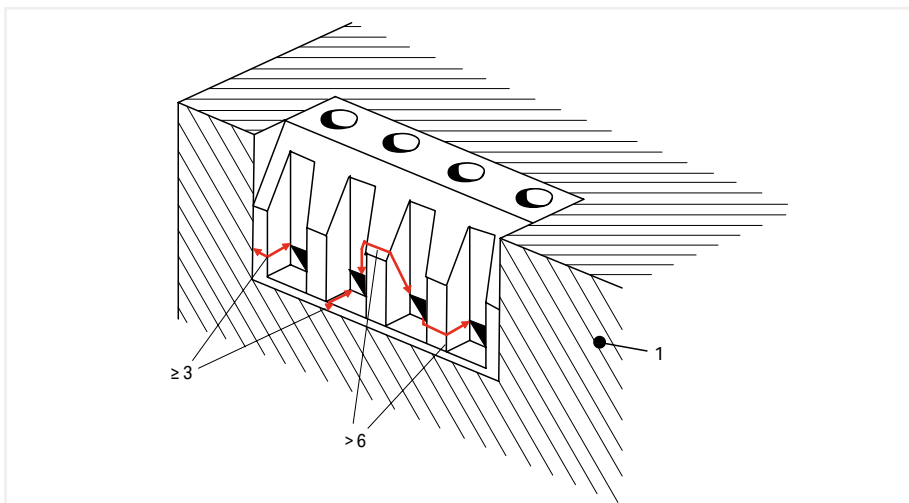
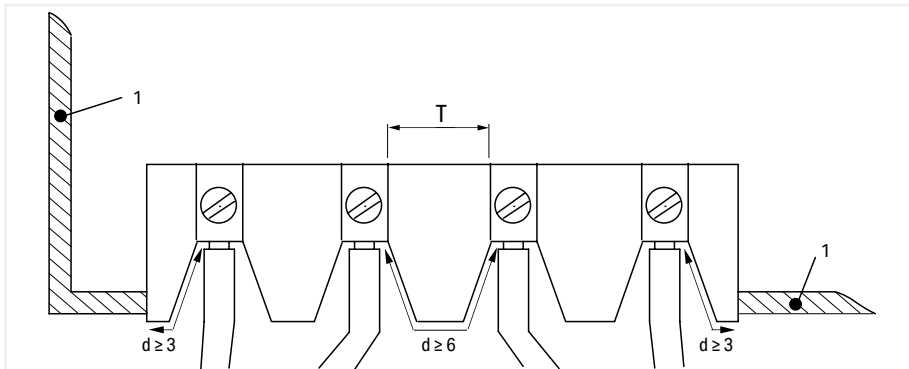

Legend:

- 1 Conductive cover
- T Distances based on Table 5
- d Distance at outer connecting parts of the terminal blocks according to 6.2.1

Note:

The dimensions indicated here represent the clearances and creepage distances around the insulation and not the thickness of the insulation.

Dimensions in mm

Figure 1a: Requirements for clearances and creepage distances for terminal blocks with isolated, intrinsically safe circuits

General Technical Information on Electrical Equipment Used in Hazardous Areas Continued

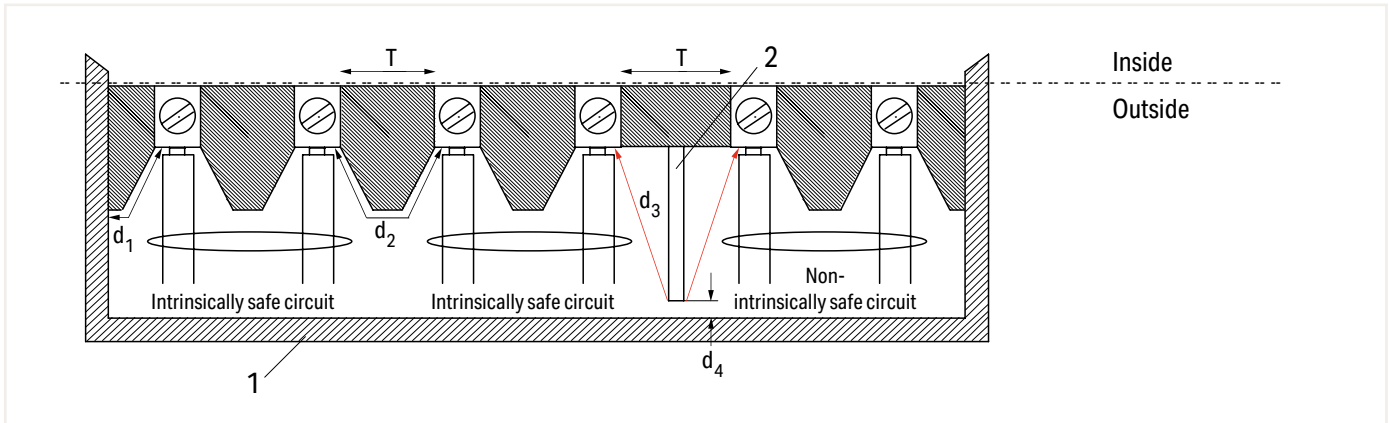

Figure 1b: Example of isolated intrinsically safe and non-intrinsically safe terminal blocks by a partition

Legend:

- 1 Cover: non-conductive or conductive and grounded
- 2 Partition based on 6.2.1 b); in this example, the partition must end at the base
- T Distances based on Table 5
- d1 ≥ 3 mm, when the cover is conductive and grounded
- d2 ≥ 6 mm
- d3 ≥ 50 mm or d4 ≤ 1.5 mm

Note:

The dimensions indicated here represent the clearances around the insulation and not the thickness of the insulation.

Table 5 – Clearances, Creepage and Isolation Distances

1 Voltage (Peak) (V)	2 Clearance (in mm)		3 Separation by Encapsulation (in mm)		4 Separation by Fixed Insulation (in mm)		5 Creepage Distance through Air (in mm)		6 Creepage Distance beneath Protective Layer (in mm)		7 Comparative Tracking Index (CTI)	
	ia, ib	ic	ia, ib	ic	ia, ib	ic	ia, ib	ic	ia, ib	ic	ia	ib, ic
10	1.5	0.4	0.5	0.2	0.5	0.2	1.5	1.0	0.5	0.3	--	
30	2.0	0.8	0.7	0.2	0.5	0.2	2.0	1.3	0.7	0.3	100	100
60	3.0	0.8	1.0	0.3	0.5	0.3	3.0	1.9	1.0	0.6	100	100
90	4.0	0.8	1.3	0.3	0.7	0.3	4.0	2.1	1.3	0.6	100	100
190	5.0	1.5	1.7	0.6	0.8	0.6	8.0	2.5	2.6	1.1	175	175
375	6.0	2.5	2.0	0.6	1.0	0.6	10.0	4.0	3.3	1.7	175	175
550	7.0	4.0	2.4	0.8	1.2	0.8	15.0	6.3	5.0	2.4	275	175
750	8.0	5.0	2.7	0.9	1.4	0.9	18.0	10.0	6.0	2.9	275	175
1000	10.0	7.0	3.3	1.1	1.7	1.1	25.0	12.5	8.3	4.0	275	175
1300	14.0	8.0	4.6	1.7	2.3	1.7	36.0	13.0	12.0	5.8	275	175
1575	16.0	10.0	5.3	*	2.7	*	49.0	15.0	16.3	*	275	175
3.3k	*	18.0	9.0	*	4.5	*	*	32.0	*	*	*	*
4.7k	*	22.0	12.0	*	6.0	*	*	50.0	*	*	*	*
9.5k	*	45.0	20.0	*	10.0	*	*	100.0	*	*	*	*
15.6k	*	70.0	33.0	*	16.5	*	*	150.0	*	*	*	*

Note 1: *At present, no values have been recommended for these voltages.

Note 2: Proof of fulfillment of the CTI requirements for the insulating materials must be provided by the manufacturer. Defining a CTI is not required for insulation materials for voltage levels up to 10 V.

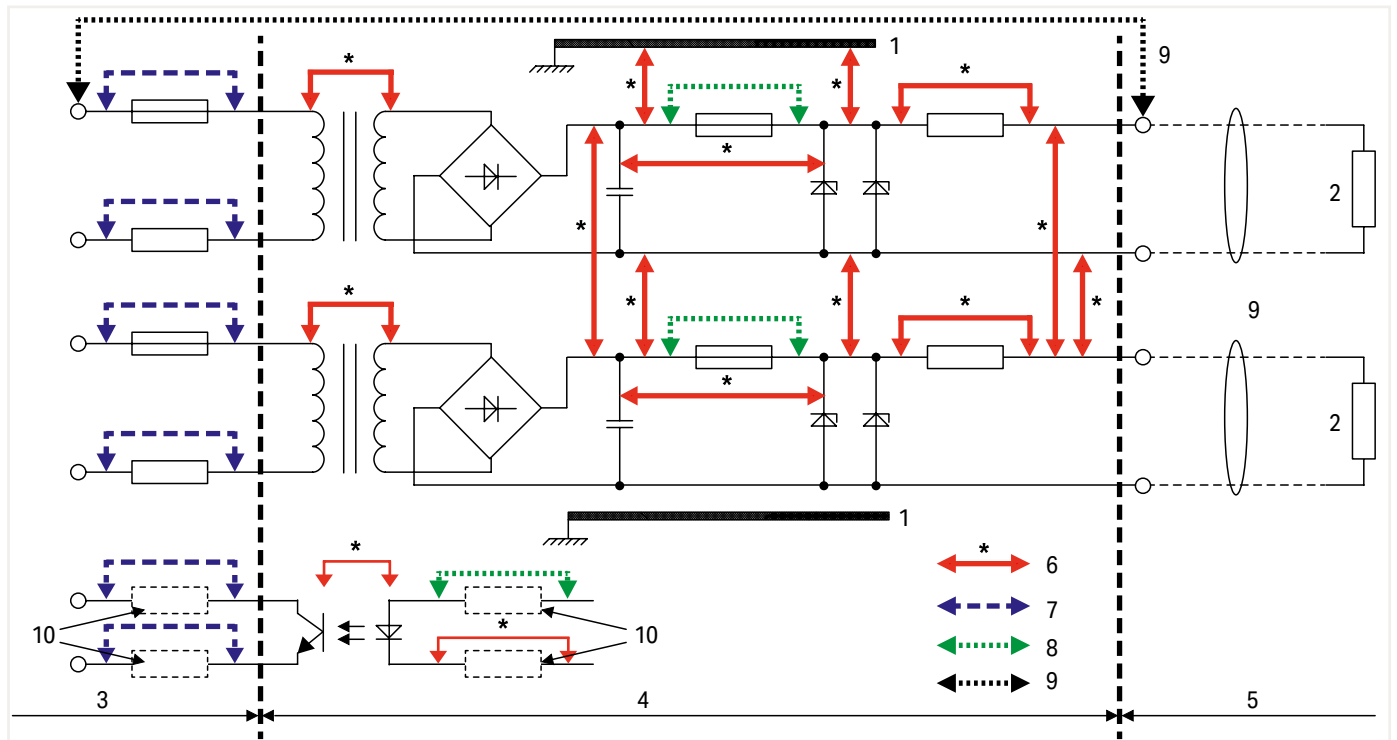

Figure 2: Isolation examples for conductive parts

Legend:





- 1 Chassis
- 2 Load
- 3 Non-intrinsically safe circuit defined by U_m
- 4 Portion of intrinsically safe circuit, item is not intrinsically safe
- 5 Intrinsically safe circuit
- 6 Dimensions for which Table 5 applies
- 7 Dimensions for which general industrial standards apply
- 8 Dimensions per 7.3
- 9 Dimensions based on 6.2.1 for output terminal blocks between isolated intrinsically safe circuits ($d_2 \geq 6 \text{ mm}$) and between intrinsically safe circuits and non-intrinsically safe circuits ($d_3 \geq 50 \text{ mm}$)
- 10 Where required











In accordance with DIN EN 60079-14 (VDE 0165-1), in intrinsically safe circuits, the ends of stranded and fine-stranded conductors must be protected against splaying (e.g., via cable lugs or ferrules) or by the type of terminal blocks used. Soldering alone is not sufficient.

The conductor entry funnels of WAGO PCB terminal blocks fulfill this requirement.

WAGO recommends gas-tight tinned copper ferrules or tinned copper pin terminals when connecting fine-stranded conductors to terminal blocks in corrosive atmospheres.

International Certification Organizations – Overview

		Abbreviation			Abbreviation
	Underwriters Laboratories USA http://www.ul.com	UL		Danmarks Elektriske Materielkontrol Denmark http://www.demko.dk	DEMKO
	Underwriters Laboratories USA http://www.ul.com	UL	CCA 	CENELEC CERTIFICATION AGREEMENT Danmarks Elektriske Materielkontrol Denmark http://www.cenelec.org	CCA Zul.-Nr. mit NL
	Underwriters Laboratories USA http://www.ul.com	cURus			
	Underwriters Laboratories USA http://www.ul.com	cULus		SETI – FEMKO Sähkötarastuskeskus Elinspektionscentralen Finland http://www.seti.fi	
	Canadian Standards Association Canada http://www.csa.ca	CSA		Sähkötarastuskeskus Elinspektionscentralen Finland http://www.fimko.com	FIMKO
	VDE-Gutachten mit Fertigungsüberwachung Germany http://www.vde.de/vde/html/e/home.htm	VDE		South African Bureau of Standards South Africa http://www.sabs.co.za	SABS
	VDE – Deutscher Verband für Elektrotechnik Germany http://www.vde.de				
VDE	VDE – Prüfbericht Germany			Departamentul Moldovastandard Moldova http://www.moldova.md/ro/government/oil/D_STAND/en/strcent2.htm	CSM
	Österreichischer Verband für Elektrotechnik Austria http://www.ove.at	ÖVE		Certificate of Registration Great Britain http://www.astacertification.com	ASTA
	Schweizerischer Elektrotechnischer Verein Switzerland http://www.sev.ch/	SEV		Rheinisch-Westfälischer Technischer Überwachungsverein e.V. Germany http://www.rwtuv.de	RWTÜV
	N.V. tot Keuring van Elektrotechnische Materialen Netherlands http://www.kema.nl	KEMA		Elektrotechnický výskumný a projektový ústav Czech Republic http://www.ezu.cz	EZU
CCA	CENELEC CERTIFICATION AGREEMENT N.V. tot Keuring van Elektrotechnische Materialen Netherlands http://www.cenelec.org	CCA Zul.-Nr. mit NL		Stowarzyszenie Elektryków Polskich Poland http://www.sep.com.pl	BBJ
				Stowarzyszenie Elektryków Polskich Poland http://www.bbj.pl	SEP
	Norges Elektriske Materialkontroll Norway http://express.nemko.com	NEMKO			
	Svenska Elektriska Materielkontrollanstalten AB Sweden http://www.semko.com	SEMKO			

		Abbreviation			Abbreviation
CNET	Centre National d'Etudes des Télécommunications France http://www.lannion.cnet.fr	CNET		Robbanásbiztos Villamos Berendezések Hungary http://www.bki.hu	BKI
LCIE	Laboratoire Central des Industries Electriques France http://www.lcie.fr	LCIE	CB	CB – TEST CERTIFICATE India http://www.ul-europe.com	CB
	Fyzikálne Technické úzkusební Ústav, Ostrava-Radvanice Czech Republic http://www.ftzu.cz	FTZU	CB	CB – TEST CERTIFICATE China http://www.ul-europe.com	CB
				http://www.enec.com	ENEC
Marine Approvals			EX Approvals		
BV	Bureau Veritas France http://www.bureauveritas.fr	BV		Physikalisch Technische Bundesanstalt Germany http://www.ptb.de	PTB
	Lloyd's Register of Shipping Great Britain http://www.lloydsregister.com	LR		Underwriters Laboratories USA http://www.ul.com	AEx
	NV – Det Norske Veritas Norway http://www.dnvgl.com	DNV-GL			
	Russian Maritime Register of Shipping GUS http://www.rs-head.spb.ru	RMR			
	Polski Rejestr Statków Poland http://www.prs.pl	PRS			
	Korean Register of Shipping Korea http://www.krs.co.kr	KR			
ABS	American Bureau of Shipping USA http://www.eagle.org	ABS			

Electrical Engineering Laboratory Product Safety for Our Customers

To use terminal blocks globally, they must satisfy certain standards and obtain test certificates. These requirements apply to every manufacturer. WAGO also conducts its own tests to increase standards and offer greater reliability with its products. Products undergo a full range of mechanical, electrical and climatic testing, and we'll share a few of those processes with you.

Pull-Out Test (per EN 60947-7-1, EN 60998-2-2)

During the pull-out force test, a conductor is pulled on until it is removed from the clamping unit. The design of the terminals means that extraction only occurs after the standard pull-out force has been exceeded many times over.

WAGO Test Lab

This means that WAGO's products can be used safely and reliably both in Europe and anywhere globally for a wide variety of applications. We heavily emphasize the importance of global acceptance during development. As a result, we can present documentation that verifies our high levels of product safety and reliability while ensuring the fulfillment and accuracy of technical data, which are the highest priorities for our customers and users worldwide. On December 22, 2009, our test lab was accredited by the German Accreditation Association (Deutsche Gesellschaft für Akkreditierung GmbH) in accordance with DIN EN ISO/IEC 17025.

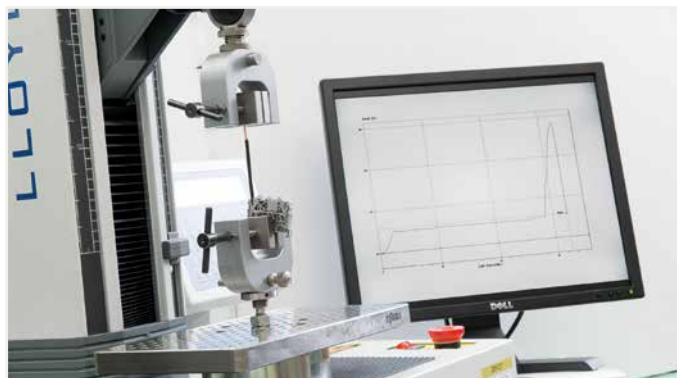

Vibration Test (per IEC/EN 60068-2-6)

Depending on the application, such as railway (per EN 61373) or marine (per GL, LR, DNV), there are various testing requirements to determine if the long-term effects of vibrations degrade electrical connections. The test specimen is subjected to different loads on three axes in an electrodynamic vibration system. The amplitude, the acceleration, and particularly the frequency of the vibration vary during the test. The test values are increased many times over the standard values to meet special customer requirements.

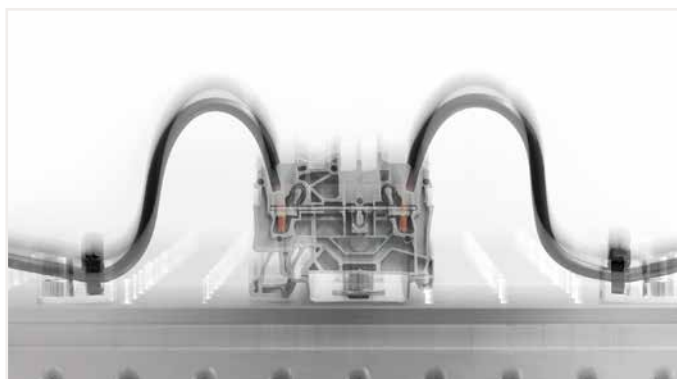

Shock Test (per IEC/EN 60068-2-27)

The shock test is very similar to the vibration test except that, instead of continuous vibrations, single shocks are applied to the test specimen. Shock tests are usually performed, for example, at an acceleration of 20g over a period of 11 ms. Tests for special requirements often call for much higher values and are also conducted in our laboratory.



Voltage Drop Test under Bending Stress (per WAGO test requirements)

The voltage drop test under bending stress simulates mechanical stress on the clamping unit. In everyday use, this stress can occur during installation, for example, when an electrician shoves connected conductors to the side in order to access a specific component. The quality of the clamping unit when moving a connected conductor can be validated by the constantly stable measured value of the voltage drop.





Deutsche Akkreditierungsstelle GmbH

Beliehene gemäß § 8 Absatz 1 AkkStelleG i.V.m. § 1 Absatz 1 AkkStelleGBV
 Unterzeichnerin der Multilateralen Abkommen
 von EA, ILAC und IAF zur gegenseitigen Anerkennung

Akkreditierung



Die Deutsche Akkreditierungsstelle GmbH bestätigt hiermit, dass

das Prüflaboratorium WAGO Kontakttechnik GmbH & Co. KG
Hansastraße 27, 32423 Minden

die Kompetenz nach DIN EN ISO/IEC 17025:2018 besitzt, Prüfungen in folgenden Bereichen durchzuführen:

**Elektrische und mechanische Prüfungen an Klemmen und Steckverbinder
 sowie Umweltsimulation**

Die Akkreditierungsurkunde gilt nur in Verbindung mit dem Bescheid vom 24.05.2019 mit der Akkreditierungsnummer D-PL-19704-01. Sie besteht aus diesem Deckblatt, der Rückseite des Deckblatts und der folgenden Anlage mit insgesamt 08 Seiten.

Registrierungsnummer der Urkunde: D-PL-19704-01-00

Frankfurt am Main, 24.05.2019

Im Auftrag Dipl.-Ing. (FH) Ralf Egner
 Abteilungsleiter

Die Urkunde samt Urkundenanlage gibt den Stand zum Zeitpunkt des Ausstellungsdatums wieder. Der jeweils aktuelle Stand des Geltungsbereiches der Akkreditierung ist der Datenbank akkreditierter Stellen der Deutschen Akkreditierungsstelle GmbH (DAkkS) zu entnehmen. <https://www.dakks.de/content/datenbank-akkreditierter-stellen>

Siehe Hinweise auf der Rückseite

WAGO-Seminars

Learn Today – Benefit Tomorrow

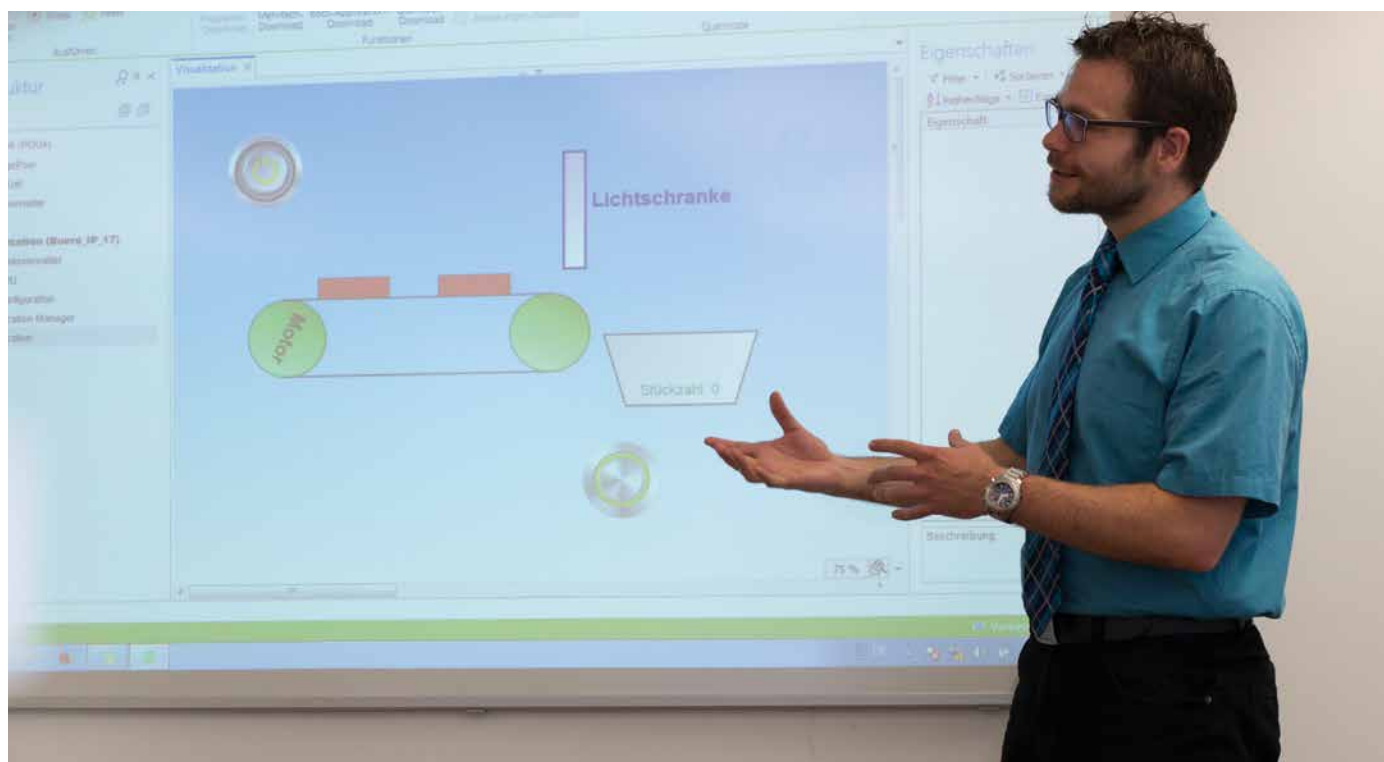

Setting the Bar with Your Goals

Product-Related and Customer-Specific Seminars



Small Groups

The small class sizes of WAGO training seminars ensures that no question goes unanswered and no one is overlooked.



Teamwork

Learning as a group is very effective. Ideas can be discussed and exchanged while experiences can be shared – all for the benefit of the participants.



Practical Topics

Experience has shown that practice makes perfect. This is why the focus of every WAGO training seminar is on practical, hands-on learning.

WAGO-Seminars

Experience the Benefits of First-Hand Knowledge and Expertise – Straight from the Source

Our instructors are specialists who know all the ins and outs of WAGO's products. This ensures that the time devoted to each WAGO training seminar is an effective investment in expanding your own expertise.

Request your registration form by email:

training@wago.com

Contact your local
WAGO office.

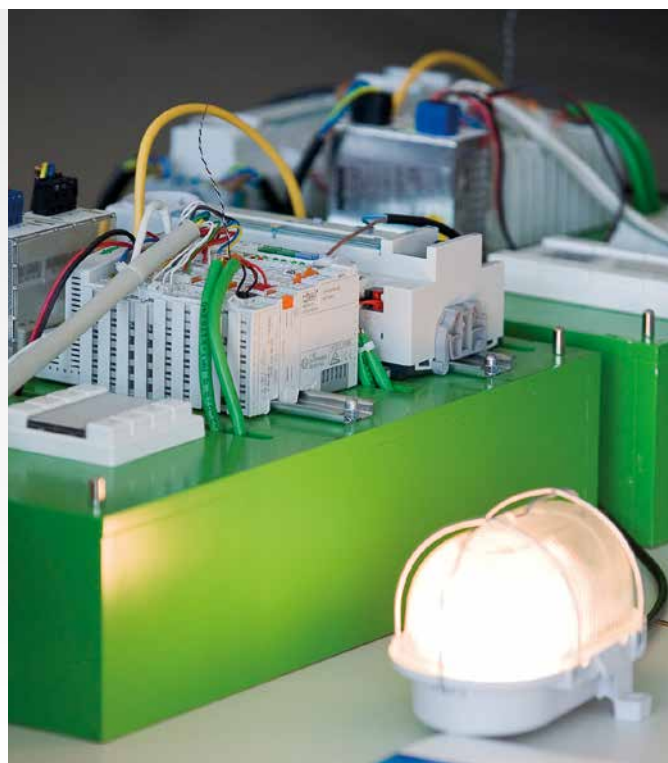

Product-Related Seminars

We regularly offer product-related seminars on the following topics:

- Building and industrial automation
- Programming of automation components
- Fieldbus systems

Current Seminars at:
www.wago.com

Customer-Specific Training Seminars

In addition to these "open" seminars, we also offer seminars specially tailored to your organization and its particular needs.

Upon request, we can also conduct these courses at your location.

Special
Corporate Seminars



Indexes and Addresses

Indexes and Addresses

	Page
Product Index	734
Item Number Index	738
Environmental protection at WAGO Success for generations	756
WAGO Worldwide	758

Product Index

Item	Page	Item	Page	Item	Page
A					
Actuator and actuator LED terminal blocks		Diode modules on carrier terminal blocks	374	Ex e II	
– Rail-mount terminal blocks, TOPJOB® S	140	– TOPJOB® S	152	– Through terminal blocks; f.-e.	
– Rail-mount terminal blocks, Classic	357	Diode modules on through terminal blocks	375	– angled type	276
– Rail-mount terminal blocks, Compact	481	– TOPJOB® S	153	– TOPJOB® S	60
Actuator terminal blocks; with a pluggable signal level	145	Diode terminal blocks; f.-e.	364	– TOPJOB® Classic	303
Additional modules for matrix patchboards	558	– TOPJOB® S	146	– horizontal type	272
"Alu-Plus" contact paste	677	Diode triple-deck terminal blocks; f.-e.		– TOPJOB® S	54
– Technical information	711	– TOPJOB® S	166	– with lever and Push-in CAGE CLAMP®	28
Angled support bracket	657	– Compact	474	– with lever and push-button	33
Assembly tool; for 294 Series	531	Disconnect and test terminal blocks; f.-e.		– with push-button	38
B					
Banana plugs	680	– angled type	326	– Double- and triple-deck terminal blocks, TOPJOB® S	72
Board sets	242	– Double-deck, TOPJOB® S	86	– Double-potential terminal blocks; f.-e.	273
Busbar carriers	629	– for current and voltage transformer circuits	322	– TOPJOB® S	55
Busbar terminal blocks	569	– TOPJOB® S	128	– Ground conductor terminal blocks; f.-e.	
C					
Cable strippers	666	– horizontal type		– angled type	276
Cable cutter	676	– Double-deck, TOPJOB® S	160	– TOPJOB® S	60
Cable knife	666	– with a pivoting knife disconnect	312	– TOPJOB® Classic	303
CAGE CLAMP® connection	2	– TOPJOB® S	104	– horizontal type	272
Carrier terminal blocks; f.-e.	338	– with push-button	92	– TOPJOB® S	54
– as double-, triple-deck terminal blocks	294	– Disconnect tab	314	– with lever and Push-in CAGE CLAMP®	28
– TOPJOB® S	105	Disconnect and test terminal blocks; s.-e.	542	– with lever and push-button	33
– with push-button	92	Disconnection tool; for 294 Series	531	– with push-button	38
– as double-deck terminal blocks	86	Disconnect terminal blocks; f.-e.		– Disconnect and test terminal blocks TOPJOB® S	104
– Multilevel installation terminal blocks, TOPJOB® S	232	– angled type		– Double-deck disconnect/test terminal blocks	160
– X-COM®S-SYSTEM-MINI	186	– for current and voltage transformer circuits	322	– High-current through terminal blocks; s.-e.	258
– X-COM®S-SYSTEM	202	– Double-deck, TOPJOB® S	86	– High-current ground conductor terminal blocks; s.-e.	258
– X-COM®S-SYSTEM; for Ex ec applications	216	– horizontal type		– Modular terminal blocks and terminal strips with mounting flanges or snap-in mounting feet	
– X-COM®-SYSTEM	394	– with a pivoting knife disconnect	328	– f.-e.	490
CE marking	684	– TOPJOB® S	104	– s.-e.	508
Certification organizations – overview	726	– with push-button	92	– Compact through terminal blocks; for DIN-35 and DIN-15 rails	466
Chassis-mount terminal strips	516	– with a disconnect tab	314	– Compact ground conductor terminal blocks; for DIN-35 and DIN-15 rails	466
CLASSIC splicing connectors for all conductor types	609	– Double-deck terminal blocks	293	– Mini through terminal blocks	
Collective jumper carriers	657	– TOPJOB® S	160	– for DIN-35 and DIN-15 rails	462
– TOPJOB® S	177	Disconnect terminal blocks for test and measurement		– TOPJOB® S; for DIN-15 rails	248
Comb-style jumper bars	383	– see "Disconnect and test terminal blocks"		– TOPJOB® S; for surface mounting	250
Common potential and matrix patching terminal blocks (4- and 8-level terminal blocks)	562	Distribution terminal blocks; f.-e.	285	– Mini ground conductor terminal blocks	462
Common potential matrix patchboards	554	Double-deck carrier terminal blocks	294	– for DIN-35 and DIN-15 rails	462
COMPACT splicing connectors	573	– TOPJOB® S	86	– TOPJOB® S; for DIN-15 rails	248
COMPACT splicing connectors (4 mm ² /12 AWG) for all conductor types	585	– X-COM®S-SYSTEM-MINI	188	– TOPJOB® S; for DIN-15 rails	248
COMPACT splicing connectors (4 mm ² /12 AWG); for Ex eb applications	594	– X-COM®S-SYSTEM	206	– TOPJOB® S; for surface mounting	250
COMPACT splicing connectors (6 mm ² /10 AWG) for all conductor types	591	– X-COM®S-SYSTEM; for Ex ec applications	220	– Mini ground conductor terminal blocks	462
COMPACT splicing connectors (6 mm ² /10 AWG); for Ex eb applications	595	– X-COM®-SYSTEM	424	– for DIN-35 and DIN-15 rails	462
Compact terminal blocks		Double-deck rail-mount terminal blocks; f.-e.	288	– TOPJOB® S; for DIN-15 rails	248
– see "Mini (rail-mount) terminal blocks"		– Compact	468	Ex i terminal blocks	
Compact terminal blocks	516	– TOPJOB® S	72	– see "Through terminal blocks"	
Compact terminal strips	485	– with push-button	70	Ex applications:	
Companies and representatives		– Disconnect terminal blocks, TOPJOB® S	86	– Technical information	715
– worldwide	758	– Disconnect and test terminal blocks, TOPJOB® S	160	Ex PUSH WIRE® connectors for junction boxes	578
Component plugs on carrier terminal blocks	158	– Carrier terminal blocks, TOPJOB® S	86	F	
Control cabinet outlet	655	– Fuse terminal blocks, TOPJOB® S	87	Felt-tip pen	651
Covers for rail-mount terminal blocks	660	– Diode and LED terminal blocks	370	Female plugs with Push-in CAGE CLAMP® connection	
Crimping tools for ferrules	670	– Compact	472	– X-COM®S-SYSTEM-MINI	190
Current-carrying capacity curves		– TOPJOB® S	164	– X-COM®S-SYSTEM	208
– X-COM®-SYSTEM	453	Double-fuse plugs on carrier terminal blocks	234	– X-COM®S-SYSTEM; for Ex ec applications	222
Current transformer terminal blocks	128	Double-potential terminal blocks; f.-e.	273	Female plugs with CAGE CLAMP® connection	
D					
Delta jumper	177	– TOPJOB® S	55	– X-COM®-SYSTEM	444
– Compact	471	– as terminal blocks for matrix patching	567	Ferrules	673
Derating curves		– Compact	467	– TOPJOB® S	671
– see "Current-carrying capacity curves"		E			
DIN-rails 15	663	EC directives	684	– High-current rail-mount terminal blocks	675
DIN-rails 35	656	Electrical interconnection sets	68	– 4-conductor chassis-mount terminal strips	672
Diode double-deck terminal blocks; f.-e.	370	Electric motor wiring (quadruple-deck) rail-mount terminal blocks	300	Field-wiring terminal blocks	524
– TOPJOB® S	164	– TOPJOB® S	90	Fuse modules; for carrier terminal blocks	338
– Compact	472	Empty component plug on carrier terminal blocks	156	– TOPJOB® S	132
E					
End stops		Environmental protection at WAGO	756	Fuse terminal blocks; f.-e.	
– for DIN-15 rail	663	Ex eb		– angled type	
– for DIN-35 rail	658	COMPACT Splicing connectors (4 mm ² /12 AWG); for Ex eb applications	594	– for automotive blade-style fuses	330
Environmental protection at WAGO	756	Ex ec		– with a pivoting fuse holder	334
Ex eb		X-COM®S-SYSTEM		– Double-deck terminal blocks, TOPJOB® S	87
COMPACT Splicing connectors (4 mm ² /12 AWG); for Ex eb applications	594	– Carrier terminal blocks	216	– horizontal type	
Ex ec		– Double-deck carrier terminal blocks	220	– TOPJOB® S	104
X-COM®S-SYSTEM		– Female plugs with Push-in CAGE CLAMP® connection	222	– with push-button	92
– Carrier terminal blocks	216	F			
– Double-deck carrier terminal blocks	220	Felt-tip pen	651	– with a pivoting fuse holder, TOPJOB® S	114
– Female plugs with Push-in CAGE CLAMP® connection	222	Female plugs with Push-in CAGE CLAMP® connection		– with push-button	102
F					
f.-e. = front-entry wiring		Ferrules	673	Fuse plugs on carrier terminal blocks	338
s.-e. = side-entry wiring		– TOPJOB® S	671	– TOPJOB® S	132
		– High-current rail-mount terminal blocks	675	– for double-/triple-deck terminal blocks	294
		– 4-conductor chassis-mount terminal strips	672	– double-, TOPJOB® S	234
		Field-wiring terminal blocks	524	Fuse terminal blocks; s.-e.	544
		Fuse modules; for carrier terminal blocks	338	– for cylindrical fuses and class CC fuses	342
		– TOPJOB® S	132		
		Fuse terminal blocks; f.-e.			
		– angled type			
		– for automotive blade-style fuses	330		
		– with a pivoting fuse holder	334		
		– Double-deck terminal blocks, TOPJOB® S	87		
		– horizontal type			
		– TOPJOB® S	104		
		– with push-button	92		
		– with a pivoting fuse holder, TOPJOB® S	114		
		– with push-button	102		
		Fuse plugs on carrier terminal blocks	338		
		– TOPJOB® S	132		
		– for double-/triple-deck terminal blocks	294		
		– double-, TOPJOB® S	234		
		Fuse terminal blocks; s.-e.	544		
		– for cylindrical fuses and class CC fuses	342		

Item	Page	Item	Page	Item	Page
G					
Ground conductor disconnect terminal blocks; f.-e.	328				
– TOPJOB® S	116				
Ground conductor disconnect terminal blocks; s.-e.	543				
Ground conductor terminal blocks, Compact					
– for DIN-35 and DIN-15 rails	466				
Ground conductor terminal blocks; f.-e.					
– angled type	276				
– TOPJOB® S	60				
– with push-button	44				
– TOPJOB® Classic	303				
– for current and voltage transformer circuits	323				
– TOPJOB® S	129				
– horizontal type	272				
– TOPJOB® S	54				
– with lever and Push-in CAGE CLAMP®	28				
– with lever and push-button	33				
– with push-button	38				
– Double-deck terminal blocks	288				
– TOPJOB® S	72				
– with push-button	70				
– Triple-deck terminal blocks	298				
– TOPJOB® S	88				
– Distribution terminal blocks, TOPJOB® S	240				
Ground conductor terminal blocks, Mini					
– for DIN-35 and DIN-15 rails	462				
– TOPJOB® S; for DIN-15 rails	248				
Ground conductor terminal blocks; s.-e.	538				
– High-current~	258				
H					
High-current rail-mount terminal blocks with POWER CAGE CLAMP connection	Section 5				
I					
IEC/EN specifications	685				
Inline splicing connectors	605				
Installation distribution terminal blocks					
– see "Multilevel installation terminal blocks"					
Installation rail-mount terminal blocks					
– see "Multilevel installation terminal blocks"					
Insulation stops					
– for rail-mount terminal blocks, Classic	382				
– X-COM®-SYSTEM	394				
– for matrix patchboards	559				
Item Number Index	738				
J					
Jumpers for rail-mount terminal blocks					
– see "Step-down jumpers, staggered jumpers, push-in type wire jumpers"					
Junction boxes; for 221 Series splicing connectors (4 mm ²)	603				
Junction box connectors	Section 13				
L					
Lamp demonstration connectors ("Service" connectors)	613				
L-BOXX® 102	614				
LED double-deck terminal blocks; f.-e.	370				
– TOPJOB® S	164				
– Compact	472				
LED modules on carrier terminal blocks	376				
– TOPJOB® S	154				
LED modules on through terminal blocks	377				
– TOPJOB® S	155				
LED terminal blocks; f.-e.	364				
– TOPJOB® S	146				
LED triple-deck terminal blocks; f.-e.					
– TOPJOB® S	166				
– Compact	474				
Lighting connectors	613				
Longitudinal switching disconnect terminal blocks	326				
Luminaire disconnect connectors	618				
M					
Male connectors with CAGE CLAMP® connection					
– X-COM®-SYSTEM	434				
Male headers with solder pins					
– X-COM®-SYSTEM	438				
Marking accessories	Section 14, Volume 6				
– Compact	471				
Material specifications for insulation/contact materials, contact plating	712				
Matrix patchboards	550				
Matrix patching and common potential terminal blocks (4- and 8-level terminal blocks)	562				
MICRO PUSH WIRE® connectors for junction boxes	582				
Mini through terminal blocks, f.-e.					
– for DIN-35 and DIN-15 rails	462				
Mini ground terminal blocks; f.-e.					
– for DIN-35 and DIN-15 rails	462				
Modular connectors					
– TOPJOB® S	168				
– X-COM®S-SYSTEM	Section 2				
– X-COM®-SYSTEM	Section 7				
Modular terminal blocks and terminal strips					
– see "Terminal blocks and terminal strips"					
Modular terminal blocks and terminal strips with mounting flanges or snap-in mounting feet					
– Compact	486				
– f.-e.	490				
– s.-e.	496				
Modular test plug adapters					
– see "Test plug adapters"					
Mounting carrier for inline splicing connectors	607				
Mounting carrier for single connectors	588				
Mounting carrier for splicing connectors					
– 221 Series (4 mm ² /12 AWG connectors)	587				
– 221 Series (6 mm ² /10 AWG connectors)	591				
– 222 Series	611				
– 243 Series	583				
– 773 Series	575				
– 773 Series Ex	579				
– 2273 Series	573				
Mounting foot					
– for isolated DIN-rail mounting	659				
– for busbars	624				
Multilevel installation terminal blocks as carrier terminal blocks TOPJOB® S	232				
Multilevel installation terminal blocks; with an internal Multilevel installation terminal blocks; with an N-disconnect slide link TOPJOB® S	228				
Multilevel installation terminal blocks; with N-disconnection TOPJOB® S	230				
Multilevel rail-mount terminal blocks					
– see "Double-, triple-, quadruple-deck terminal blocks"					
Multilevel terminal blocks					
– see "Multilevel installation terminal blocks"					
– see "Double-, triple- and quadruple-deck terminal blocks"					
N					
N-conductor disconnect terminal blocks					
– TOPJOB® S	238				
– TOPJOB® Classic	307				
Neon lamp modules on carrier terminal blocks	376				
Neon lamp modules on through terminal blocks	377				
O					
Operating pliers	665				
Operating tools	664				
– TOPJOB® S	664				
– TOPJOB® Classic	303				
– High-current rail-mount terminal blocks	665				
Order form available upon request					
P					
Patchboard systems					
– Matrix patchboards	550				
– Common potential matrix patchboards	554				
– Matrix patching and common potential terminal blocks (4- and 8-level terminal blocks)	562				
– Terminal blocks for matrix patching (3-conductor, double-potential terminal blocks)	567				
Pluggable tap-off modules	477				
POWER CAGE CLAMP connection	3				
Power distribution disconnect terminal blocks					
– TOPJOB® S	238				
– TOPJOB® Classic	307				
Power taps; for high-current terminal blocks	258				
Printer	653				
Push-in CAGE CLAMP® connection	2				
Push-in type wire jumpers for rail-mount terminal blocks	385				
– TOPJOB® S	178				
PUSH WIRE® connection	3				
PUSH WIRE® connectors for junction boxes	576				
PUSH WIRE® connectors for junction boxes, Ex e II	578				
PUSH WIRE® connectors for junction boxes, MICRO	582				
Q					
Quadruple-deck rail-mount terminal blocks (for fast electric motor wiring)	300				
– TOPJOB® S	90				
R					
Rail end cap; for DIN-35 rail	656				
Rail-mount spacer blocks	274				
Rail-mount terminal block sets	68				
S					
Screwdrivers					
– see "Operating tools"					
Sensor and sensor LED terminal blocks					
– Rail-mount terminal blocks, TOPJOB® S	138				
– Rail-mount terminal blocks, Classic	348				
– Rail-mount terminal blocks, Compact	479				
Sensor terminal blocks; with a pluggable signal level	143				
"Service" connectors	613				
Sets, electrical interconnection set and rail-mount terminal block set	68				
Shield clamping saddles	624				
Shield clamps	628				
Shield terminal blocks					
– angled type	276				
– TOPJOB® S	60				
– TOPJOB® Classic	303				
– horizontal type	272				
– TOPJOB® S	56				
– Double-deck terminal blocks, TOPJOB® S	73				
– Triple-deck terminal blocks	298				
– TOPJOB® S	88				
Spacers for sensor/actuator terminal blocks	348				
Specifications IEC/EN	685				
Specifications UL – Underwriters Laboratories, USA	706				
Splicing connectors (4 mm ² /12 AWG) for all conductor types, COMPACT	585				
Splicing connectors (4 mm ² /12 AWG); for Ex eb applications, COMPACT	594				
Splicing connectors (6 mm ² /10 AWG) for all conductor types, COMPACT	591				
Splicing connectors (6 mm ² /10 AWG); for Ex eb applications, COMPACT	595				
Splicing connectors, COMPACT	573				
Splicing connectors for all conductor types, CLASSIC	609				
Splicing connector set	614				
Spring-equipped shield clamping saddles	627				
Staggered jumpers for rail-mount terminal blocks	384				
– TOPJOB® S	176				
Star point jumper	177				

Item	Page	Item	Page	Item	Page

Item Number Index

Item No.	Page	Item No.	Page	Item No.	Page	Item No.	Page
206 Series		209 Series		210 Series		210 Series	
206-118	676	209-170	273	210-333/1000-208	643	210-345	648
		209-173	452	210-333/1200-001	644		
206-294	531	209-174	452	210-333/1200-074	644	210-412	323
		209-183	651	210-333/1200-075	644	210-413	323
206-706	679	209-184	651	210-333/1200-076	644	210-414	323
206-707	679	209-185	651	210-333/1200-077	644	210-415	323
		209-190	38	210-333/1200-078	644	210-423	327
206-804	678	209-191	38	210-333/1200-079	644	210-424	327
206-808	679	209-192	70	210-333/1200-103	644	210-490	435
		209-196	661	210-333/1200-104	644		
				210-333/1200-105	644	210-504	657
206-1125	669	209-290	490	210-333/1200-106	644	210-505	657
206-1126	669			210-333/1200-107	644	210-506	657
206-1127	669			210-333/1200-203	644	210-508	657
206-1128	669	209-500/209-035	550	210-333/500-001	642	210-509	657
206-1129	669	209-501	452	210-333/500-002	642	210-549	661
206-1131	669	209-502	550	210-333/500-003	642		
206-1132	669	209-566	550	210-333/500-004	642	210-612	651
				210-333/500-005	642	210-647	664
206-1204	670	209-700/209-124	295	210-333/500-006	642	210-648	664
206-1205	670	209-700/209-125	295	210-333/500-007	642	210-657	664
206-1206	670	209-700/209-126	295	210-333/500-008	642	210-658	664
206-1216	670	209-700/209-127	295	210-333/500-009	642		
206-1225	674	209-701	295	210-333/500-010	642	210-719	664
206-1250	674	209-701/000-002	295	210-333/500-011	642	210-720	664
		209-701/000-005	295	210-333/500-021	642	210-721	664
206-1400	666	209-701/000-006	295	210-333/500-074	642	210-722	664
206-1403	666	209-701/000-007	295	210-333/500-075	642		
206-1411	666	209-701/000-012	295	210-333/500-076	642	215 Series	
206-1412	666	209-701/000-017	295	210-333/500-077	642	215-111	680
206-1413	666	209-701/000-023	295	210-333/500-078	642	215-211	680
206-1414	666	209-701/000-024	295	210-333/500-079	642	215-212	680
206-1415	666	209-787	295	210-333/600-001	643		
206-1418	666			210-333/600-006	643	215-311	680
206-1419	666	209-1115	607	210-333/600-007	643		
206-1441	667	209-1116	607	210-333/600-008	643	215-411	680
206-1442	667			210-333/600-009	643		
206-1451	667	210 Series		210-333/600-010	643	215-511	680
206-1481	668	210-103	151	210-333/600-011	643		
206-1482	668	210-110	651	210-333/600-021	643	215-611	680
206-1491	668	210-111	663	210-333/600-074	643		
206-1492	668	210-112	656	210-333/600-075	643	215-711	680
		210-113	656	210-333/600-076	643		
207 Series		210-114	656	210-333/600-077	643	215-811	680
207-1331	599	210-115	656	210-333/600-078	643		
207-1332	599	210-118	656	210-333/600-079	643	215-911	680
207-1333	599	210-123	151	210-333/600-103	643		
		210-133	228	210-333/600-104	643	216 Series	
207-1431	599	210-136	681	210-333/600-105	643	216-101	673
207-1432	599	210-141	665	210-333/600-106	643	216-102	673
207-1433	599	210-143	665	210-333/700-001	644	216-103	673
207-4301	603	210-148	657	210-333/700-020	644	216-104	673
		210-149	657	210-333/700-021	644	216-106	673
		210-154	251	210-333/700-074	644	216-107	673
		210-196	656	210-333/700-075	644	216-108	673
		210-197	656	210-333/700-076	644	216-109	673
		210-198	656	210-333/700-077	644	216-110	673
				210-333/700-078	644	216-121	673
		210-254	102	210-333/700-079	644	216-122	673
		210-281	228	210-333/700-108	644	216-123	673
		210-295	663	210-333/700-109	644	216-124	673
		210-296	663	210-333/800-001	642	216-131	673
		210-297	307	210-333/800-002	642	216-132	673
				210-333/800-003	642	216-141	672
		210-331	642	210-333/800-004	642	216-142	672
		210-332	642	210-333/800-005	642	216-143	672
		210-333	642	210-333/800-006	642	216-144	672
		210-333/1000-001	643	210-333/800-007	642	216-151	673
		210-333/1000-074	643	210-333/800-008	642	216-152	673
		210-333/1000-075	643	210-333/800-009	642		
		210-333/1000-076	643	210-333/800-010	642	216-201	673
		210-333/1000-077	643	210-333/800-011	642	216-202	673
		210-333/1000-078	643	210-333/800-074	642	216-203	673
		210-333/1000-079	643	210-333/800-075	642	216-204	673
		210-333/1000-110	643	210-333/800-076	642	216-205	673
		210-333/1000-111	643	210-333/800-077	642	216-206	673
		210-333/1000-112	643	210-333/800-078	642	216-207	673
		210-333/1000-113	643	210-333/800-079	642	216-208	671
		210-333/1000-202	643	210-333/800-209	642	216-210	671
		210-333/1000-204	643	210-334	642		
		210-333/1000-206	643	210-335	642		

Item No.	Page	Item No.	Page	Item No.	Page	Item No.	Page
216 Series		221 Series		249 Series		260 Series	
216-221	673	221-942/000-006	597	249-116	658	260-311	496
216-222	673			249-117	658	260-313	496
216-223	673	221-2401	605	249-118	649	260-314	496
216-224	673	221-2411	605	249-119	649	260-316	496
216-241	671			249-120	649	260-317	496
216-242	671	221-2501	607	249-125	385	260-321	496
216-243	671	221-2502	607	249-126	385	260-323	496
216-244	671	221-2503	607	249-127	385	260-324	496
216-246	671	221-2504	607	249-130	677	260-326	496
216-262	671	221-2505	607	249-135	510	260-327	496
216-263	671	221-2511	607	249-136	510	260-331	496
216-264	671	221-2512	607	249-137	510	260-333	496
216-266	671	221-2513	607	249-138	510	260-334	496
216-267	671	221-2514	607	249-139	510	260-336	496
216-284	671	221-2515	607	249-140	510	260-337	496
216-286	671	221-2521	607	249-141	378	260-341	496
216-287	671	221-2522	607	249-142	378	260-343	496
216-288	671	221-2523	607	249-143	378	260-344	496
216-289	671	221-2524	607	249-144	378	260-346	496
		221-2525	607	249-145	378	260-347	496
216-301	673	221-2531	607	249-146	378	260-351	496
216-302	673	221-2532	607	249-147	379	260-353	496
216-321	673	221-2533	607	249-148	379	260-354	496
216-322	673	221-2534	607	249-197	658	260-356	496
		221-2535	607			260-357	496
				258 Series		260-361	496
216-413	675			258-5000	653	260-371	496
216-414	675			258-5030	653		
216-424	675	222 Series		260 Series		260-402	496
216-425	675	222-412	609	260-102	497	260-404	510
216-435	675	222-413	609	260-103	497	260-405	510
		222-415	609	260-104	497		
				260-105	497		
216-545	343			260-106	497	261 Series	
216-546	343	222-500	611	260-107	497	261-102	499
216-547	343	222-505	587	260-108	497	261-102/331-000	501
		222-510	587	260-109	497	261-102/341-000	503
				260-110	497	261-103	499
221 Series		224 Series		260-111	497	261-103/331-000	501
221-412	585	224-101	613	260-112	497	261-103/341-000	503
221-413	585	224-104	613	260-112	497	261-104	499
221-415	585	224-112	613	260-152	497	261-104/331-000	501
221-482	594	224-114	613	260-153	497	261-104/341-000	503
221-483	594			260-154	497	261-105	499
221-485	594			260-155	497	261-105/331-000	501
		224-201	613	260-156	497	261-106	499
221-500	587	243 Series		260-157	497	261-106/331-000	501
221-500/000-006	587	243-110	583	260-158	497	261-106/341-000	503
221-500/000-006	594	243-112	583	260-159	497	261-107	499
221-500/000-053	587	243-113	583	260-160	497	261-107/331-000	501
221-501	594	243-144	582	260-161	497	261-107/341-000	503
221-502	589			260-162	497	261-108	499
221-502/000-004	589	243-204	582			261-108/331-000	501
221-503	589	243-208	582	260-202	497	261-108/341-000	503
221-503/000-004	589			260-203	497	261-109	499
221-505	589	243-304	582	260-204	497	261-109/331-000	501
221-505/000-004	589	243-308	582	260-205	497	261-109/341-000	503
221-510	591			260-206	497	261-110	499
221-510/000-006	591	243-504	582	260-207	497	261-110/331-000	501
221-510/000-053	591	243-508	582	260-208	497	261-110/341-000	503
221-511	595			260-209	497	261-111	499
221-512	589	243-804	582	260-210	497	261-111/331-000	501
221-512/000-004	589	243-808	582	260-211	497	261-111/341-000	503
221-513	589	248 Series		260-212	497	261-112	499
221-513/000-004	589	248-501	641	260-252	497	261-112/331-000	501
221-515	589	248-501/000-002	641	260-253	497	261-112/341-000	503
221-515/000-004	589	248-501/000-005	641	260-254	497	261-152	499
221-522	589	248-501/000-006	641	260-255	497	261-152/331-000	501
221-522/000-004	589	248-501/000-007	641	260-256	497	261-152/341-000	503
221-523	589	248-501/000-012	641	260-257	497	261-153	499
221-523/000-004	589	248-501/000-017	641	260-258	497	261-153/331-000	501
221-525	589	248-501/000-023	641	260-259	497	261-153/341-000	503
221-525/000-004	589	248-501/000-024	641	260-260	497	261-154	499
				260-261	497	261-154/331-000	501
221-612	591	249 Series		260-262	497	261-154/341-000	503
221-613	591	249-101	663			261-155	499
221-615	591	249-105	651	260-301	496	261-155/331-000	501
221-682	595	249-106	379	260-303	496	261-155/341-000	503
221-683	595	249-107	379	260-304	496	261-156	499
221-685	595	249-109	562	260-306	496	261-156/331-000	501
				260-307	496	261-156/341-000	503
221-941	597						
221-941/000-006	597						
221-942	597						

Item Number Index

Item No.	Page	Item No.	Page	Item No.	Page	Item No.	Page
261 Series		261 Series		261 Series		262 Series	
261-157	499	261-261/342-000	503	261-351/332-000	500	262-141	509
261-157/331-000	501	261-262	499	261-351/342-000	502	262-142	509
261-157/341-000	503	261-262/332-000	501	261-353	498	262-152	507
261-158	499	261-262/342-000	503	261-353/332-000	500	262-153	507
261-158/331-000	501			261-353/342-000	502	262-154	507
261-158/341-000	503	261-301	498	261-354	498	262-155	507
261-159	499	261-301/331-000	500	261-354/332-000	500	262-156	507
261-159/331-000	501	261-301/341-000	502	261-354/342-000	502	262-157	507
261-159/341-000	503	261-303	498	261-356	498	262-158	507
261-160	499	261-303/331-000	500	261-356/332-000	500	262-159	507
261-160/331-000	501	261-303/341-000	502	261-356/342-000	502	262-160	507
261-160/341-000	503	261-304	498	261-357	498	262-161	507
261-161	499	261-304/331-000	500	261-357/332-000	500	262-162	507
261-161/331-000	501	261-304/341-000	502	261-357/342-000	502	262-180	508
261-161/341-000	503	261-306	498	261-361	498	262-181	508
261-162	499	261-306/331-000	500	261-371	498	262-182	509
261-162/331-000	501	261-306/341-000	502			262-183	509
261-162/341-000	503	261-307	498	261-402	498	262-184	509
		261-307/331-000	500	261-404	510	262-185	509
261-202	499	261-307/341-000	502	261-405	510	262-186	509
261-202/332-000	501	261-311	498	261-410	504	262-187	509
261-202/342-000	503	261-311/331-000	500	261-411	504	262-188	509
261-203	499	261-311/341-000	502	261-411/331-000	504	262-189	509
261-203/332-000	501	261-313	498	261-411/341-000	504	262-190	509
261-203/342-000	503	261-313/331-000	500	261-422	505	262-191	509
261-204	499	261-313/341-000	502	261-422/331-000	505	262-192	509
261-204/332-000	501	261-314	498	261-422/341-000	505		
261-204/342-000	503	261-314/331-000	500	261-423	505	262-202	507
261-205	499	261-314/341-000	502	261-423/331-000	505	262-203	507
261-205/332-000	501	261-316	498	261-423/341-000	505	262-204	507
261-205/342-000	503	261-316/331-000	500	261-424	505	262-205	507
261-206	499	261-316/341-000	502	261-424/331-000	505	262-206	507
261-206/332-000	501	261-317	498	261-424/341-000	505	262-207	507
261-206/342-000	503	261-317/331-000	500	261-425	505	262-208	507
261-207	499	261-317/341-000	502	261-425/331-000	505	262-209	507
261-207/332-000	501	261-321	498	261-425/341-000	505	262-210	507
261-207/342-000	503	261-321/331-000	500	261-426	505	262-211	507
261-208	499	261-321/341-000	502	261-426/331-000	505	262-212	507
261-208/332-000	501	261-323	498	261-426/341-000	505	262-230	508
261-208/342-000	503	261-323/331-000	500	261-427	505	262-232	509
261-209	499	261-323/341-000	502	261-427/331-000	505	262-233	509
261-209/332-000	501	261-324	498	261-427/341-000	505	262-234	509
261-209/342-000	503	261-324/331-000	500	261-428	505	262-235	509
261-210	499	261-324/341-000	502	261-428/331-000	505	262-236	509
261-210/332-000	501	261-326	498	261-428/341-000	505	262-237	509
261-210/342-000	503	261-326/331-000	500	261-429	505	262-238	509
261-211	499	261-326/341-000	502	261-429/331-000	505	262-239	509
261-211/332-000	501	261-327	498	261-429/341-000	505	262-240	509
261-211/342-000	503	261-327/331-000	500	261-430	505	262-241	509
261-212	499	261-327/341-000	502	261-430/331-000	505	262-242	509
261-212/332-000	501	261-331	498	261-430/341-000	505	262-252	507
261-212/342-000	503	261-331/332-000	500	261-431	505	262-253	507
261-252	499	261-331/342-000	502	261-431/331-000	505	262-254	507
261-252/332-000	501	261-333	498	261-431/341-000	505	262-255	507
261-252/342-000	503	261-333/332-000	500	261-432	505	262-256	507
261-253	499	261-333/342-000	502	261-432/331-000	505	262-257	507
261-253/332-000	501	261-334	498	261-432/341-000	505	262-258	507
261-253/342-000	503	261-334/332-000	500			262-259	507
261-254	499	261-334/342-000	502	262 Series		262-260	507
261-254/332-000	501	261-336	498	262-102	507	262-261	507
261-254/342-000	503	261-336/332-000	500	262-103	507	262-262	507
261-255	499	261-336/342-000	502	262-104	507	262-280	508
261-255/332-000	501	261-337	498	262-105	507	262-281	508
261-255/342-000	503	261-337/332-000	500	262-106	507	262-282	509
261-256	499	261-337/342-000	502	262-107	507	262-283	509
261-256/332-000	501	261-341	498	262-108	507	262-284	509
261-256/342-000	503	261-341/332-000	500	262-109	507	262-285	509
261-257	499	261-341/342-000	502	262-110	507	262-286	509
261-257/332-000	501	261-343	498	262-111	507	262-287	509
261-257/342-000	503	261-343/332-000	500	262-112	507	262-288	509
261-258	499	261-343/342-000	502	262-130	508	262-289	509
261-258/332-000	501	261-344	498	262-132	509	262-290	509
261-258/342-000	503	261-344/332-000	500	262-133	509	262-291	509
261-259	499	261-344/342-000	502	262-134	509	262-292	509
261-259/332-000	501	261-346	498	262-135	509		
261-259/342-000	503	261-346/332-000	500	262-136	509	262-301	506
261-260	499	261-346/342-000	502	262-137	509	262-304	506
261-260/332-000	501	261-347	498	262-138	509	262-306	506
261-260/342-000	503	261-347/332-000	500	262-139	509	262-307	506
261-261	499	261-347/342-000	502	262-140	509	262-311	506
261-261/332-000	501	261-351	498			262-314	506

Item No.	Page	Item No.	Page	Item No.	Page	Item No.	Page
262 Series		264 Series		264 Series		279 Series	
262-316	506	264-207	492	264-701	463	279-440	383
262-317	506	264-208	492	264-704	463	279-470	382
262-321	506	264-209	492	264-706	463	279-471	382
262-324	506	264-210	492	264-711	462	279-482	383
262-326	506	264-211	492	264-714	462	279-483	383
262-327	506	264-212	492	264-716	462	279-490	383
262-331	506	264-220	463	264-721	463	279-492	383
262-334	506	264-225	462	264-724	463		
262-336	506	264-230	490	264-726	463	279-501	288
262-337	506	264-231	490	264-727	463	279-504	288
262-341	506	264-232	493	264-727/999-950	463	279-507	288
262-344	506	264-233	493	264-731	462	279-508	288
262-346	506	264-234	493	264-734	462	279-509	288
262-347	506	264-235	493	264-736	462	279-512	288
262-351	506	264-236	493	264-737	462	279-513	288
262-354	506	264-237	493	264-737/999-950	462	279-517	288
262-356	506	264-238	493			279-518	289
262-357	506	264-239	493	264-900	641	279-519	289
262-361	506	264-240	493	264-901	641	279-527	288
262-363	508	264-241	493	264-902	641	279-529	289
262-371	506	264-242	493	264-903	641		
262-373	508	264-252	492	264-904	641	279-673/281-410	364
		264-253	492	264-905	641	279-673/281-411	364
262-402	506	264-254	492			279-674/281-413	364
		264-255	492			279-674/281-434	364
		264-256	492	270 Series		279-681	272
264 Series		264-257	492	270-319	481	279-682	272
264-102	492	264-258	492	270-320	479	279-683	272
264-103	492	264-259	492	270-321	481	279-684	272
264-104	492	264-260	492	270-322	479	279-685	272
264-105	492	264-261	492			279-686	272
264-106	492	264-262	492	270-409	479	279-687	272
264-107	492	264-280	491	270-417	479	279-687/999-950	272
264-108	492	264-282	493	270-480	479		
264-109	492	264-283	493			279-809/281-413	364
264-110	492	264-284	493	270-560	480	279-809/281-434	364
264-111	492	264-285	493	270-560/281-434	480	279-815/281-410	364
264-112	492	264-286	493	270-560/281-507	480	279-815/281-411	364
264-120	463	264-287	493	270-564	480	279-826	273
264-125	462	264-288	493	270-564/281-483	480	279-831	272
264-130	490	264-289	493	270-570	479	279-832	272
264-131	490	264-290	493	270-570/281-434	479	279-833	272
264-132	492	264-291	493	270-570/281-507	479	279-834	272
264-133	492	264-292	493	270-572	481	279-835	272
264-134	492			270-572/281-434	481	279-836	272
264-135	492	264-301	490	270-574	479	279-837	272
264-136	492	264-304	490	270-577	481	279-837/999-950	272
264-137	492	264-306	490	270-585	481	279-838	272
264-138	492	264-307	490	270-585/281-507	481		
264-139	492	264-311	491	270-586	481	279-901	272
264-140	492	264-314	491			279-902	272
264-141	492	264-316	491	279 Series		279-903	272
264-142	492	264-317	491	279-101	538	279-904	272
264-152	492	264-321	490	279-104	538	279-905	272
264-153	492	264-324	490			279-906	272
264-154	492	264-326	490	279-308	272	279-907	272
264-155	492	264-327	490	279-309	272	279-907/999-950	272
264-156	492	264-331	490	279-325	272	279-915/281-410	364
264-157	492	264-334	490	279-326	272	279-915/281-411	364
264-158	492	264-336	490	279-328	272	279-992	272
264-159	492	264-337	490	279-329	272	279-993	272
264-160	492	264-341	491	279-330	272	279-994	272
264-161	492	264-344	491	279-331	272	279-995	273
264-162	492	264-346	491	279-339	272		
264-180	491	264-347	491	279-340	272	280 Series	
264-182	492	264-351	490	279-341	272	280-101	538
264-183	492	264-354	490	279-342	272	280-104	538
264-184	492	264-356	490	279-344	272	280-107	538
264-185	492	264-357	490	279-345	272		
264-186	492	264-361	490	279-346	272	280-301	538
264-187	492	264-363	490	279-347	272	280-302	538
264-188	492	264-364	490	279-348	272	280-303	294
264-189	492	264-367	462	279-349	272	280-304	294
264-190	492	264-368	462			280-305	294
264-191	492	264-369	462	279-402	272	280-306	294
264-192	492	264-370	462	279-405	538	280-308	274
		264-371	491	279-409	272	280-309	274
264-202	492	264-373	491	279-415	273	280-310	274
264-203	492	264-374	491	279-422	272	280-311	274
264-204	492			279-432	383	280-312	276
264-205	492	264-402	462	279-433	383		
264-206	492						

Item Number Index

Item No.	Page	Item No.	Page	Item No.	Page	Item No.	Page
280 Series		280 Series		280 Series		280 Series	
280-313	276	280-525	293	280-637	276	280-884	313
280-314	274	280-526	293	280-637/999-950	276	280-885	313
280-315	274	280-527	292	280-640	276	280-889	295
280-318	276	280-528	294	280-641	276	280-891	294
280-319	349	280-529	292	280-646	277		
280-320	351	280-530	292	280-650	274	280-901	274
280-321	349	280-531	294	280-650/056-000	274	280-902	274
280-322	538	280-532	294	280-651	276	280-902/056-000	274
280-323	351	280-533	292	280-653	274	280-903	274
280-324	274	280-534	292	280-654	276	280-904	274
280-325	567	280-537	292	280-654/056-000	276	280-905	274
280-326	274	280-543	293	280-654/056-000	277	280-906	274
280-332	538	280-547	298	280-656	277	280-907	274
280-333	567	280-548	298	280-671	274	280-907/999-950	274
280-334	274	280-549	298	280-672	274	280-912	314
280-335	274	280-550	298	280-673/281-410	366	280-913	314
280-336	294	280-551	298	280-673/281-411	366	280-914	314
280-339	294	280-552	298	280-675	567	280-915/281-410	366
280-340	292	280-553	348	280-681	274	280-915/281-411	366
280-341	292	280-554	357	280-683	314	280-916	340
280-342	292	280-555	357	280-684	274	280-940/281-410	370
280-343	292	280-556	357	280-687	274	280-940/281-411	370
280-344	274	280-557	298	280-687/999-950	274	280-941/281-489	370
280-346	274	280-558	298			280-941/281-490	370
280-348	276	280-559	348	280-801/281-411	374	280-941/281-491	370
280-352	274	280-560	348	280-801/281-413	376	280-941/281-492	370
280-353	274	280-560/281-434	350	280-801/281-414	376	280-942/281-487	370
280-354	276	280-561	348	280-801/281-415	376	280-942/281-488	370
280-355	276	280-561/281-413	350	280-801/281-416	376	280-943/281-413	370
280-356	274	280-562	358	280-801/281-417	376	280-943/281-434	370
280-357	274	280-562/281-411	358	280-801/281-418	376	280-946	277
280-358	274	280-562/281-420	362	280-801/281-420	374	280-992	274
280-359	274	280-562/281-434	362	280-801/281-421	374	280-993	274
280-366	292	280-563	348	280-803/281-411	375	280-994	274
280-369	292	280-564	348	280-803/281-414	377	280-995	275
280-371	312	280-564/281-483	350	280-803/281-415	377	280-996	277
280-373	313	280-565	358	280-803/281-416	377	280-998	276
280-374	312	280-565/281-319	358	280-803/281-417	377		
280-376	313	280-565/281-321	358	280-803/281-418	377		
280-394	567	280-566	358	280-803/281-420	375	281 Series	
280-395	567	280-566/281-496	350	280-803/281-421	375	281-101	538
		280-567	348	280-805	314	281-104	538
280-402	275	280-568	358	280-809/281-413	366	281-107	538
280-404	273	280-570	352	280-809/281-434	366		
280-405	467	280-570/281-434	351	280-815/281-410	366	281-301	538
280-409	275	280-571	352	280-815/281-411	366	281-302	538
280-415	275	280-571/281-413	351	280-816	340	281-309	335
280-418	380	280-572	360	280-826	275	281-311	335
280-419	380	280-572/281-411	360	280-829	314	281-312	279
280-422	275	280-572/281-420	362	280-830	274	281-313	279
280-432	383	280-572/281-434	362	280-831	274	281-318	279
280-433	383	280-573	352	280-832	274	281-322	538
280-434	665	280-574	352	280-833	274	281-324	278
280-435	665	280-574/281-483	351	280-834	274	281-326	278
280-436	665	280-575	360	280-835	274	281-328	278
280-437	665	280-575/281-320	360	280-835/056-000	274	281-329	278
280-438	665	280-575/281-323	360	280-836	314	281-330	278
280-439	665	280-576	360	280-837	274	281-331	278
280-440	383	280-576/281-496	351	280-837/999-950	274	281-332	538
280-470	382	280-577	352	280-838	274	281-333	541
280-471	382	280-577/281-496	351	280-839	314	281-334	278
280-472	382	280-578	360	280-850	340	281-335	278
280-473	567	280-580	354	280-850/281-413	340	281-338	278
280-474	567	280-580/281-434	356	280-852	340	281-339	278
280-482	383	280-581/281-413	356	280-852/281-413	340	281-340	296
280-483	383	280-582	352	280-854	340	281-341	296
280-490	383	280-583	363	280-854/281-413	340	281-342	296
280-492	383	280-584	354	280-856	340	281-343	296
280-494	567	280-584/281-483	356	280-856/281-413	340	281-344	278
		280-585	363	280-868	312	281-345	278
280-510	295	280-586	363	280-869	312	281-346	278
280-513	293	280-586/281-496	356	280-870	312	281-347	278
280-514	294	280-587	354	280-871	312	281-348	279
280-515	363	280-588	354	280-874	313	281-349	278
280-517	292	280-588/280-320	354	280-875	313	281-350	278
280-519	292	280-588/280-323	354	280-876	312	281-355	278
280-520	292	280-592	358	280-879	312	281-356	278
280-521	293	280-593	360	280-880	312	281-357	279
280-522	293	280-597	298	280-881	313	281-358	279
280-523	292			280-882	313	281-365	300
280-524	292	280-610	340	280-883	313	281-366	300

Item No.	Page	Item No.	Page	Item No.	Page	Item No.	Page
281 Series		281 Series		282 Series		282 Series	
281-402	279	281-658	278	282-332	539	282-697	328
281-405	538	281-659	316	282-333	328	282-698/281-413	330
281-407	275	281-660	316	282-334	328	282-698/281-429	330
281-409	279	281-663	278	282-339	280	282-698/281-434	330
281-415	279	281-664	278	282-340	280	282-698/281-449	330
281-418	380	281-665/281-400	368	282-341	280	282-699	328
281-419	380	281-665/281-401	368	282-342	280		
281-421	293	281-665/281-410	368	282-357	280	282-811	326
281-422	279	281-665/281-411	368	282-358	280	282-821	326
281-440	383	281-666	316	282-360	326	282-841	326
281-470	382	281-668	278	282-361	326	282-841/049-000	326
281-471	382	281-672	334	282-365	326	282-860	322
281-472	382	281-673/281-400	368	282-366	326	282-865	322
281-482	383	281-673/281-401	368	282-367	280	282-866	322
281-483	383	281-673/281-410	368	282-368	280	282-868	322
281-485	383	281-673/281-411	368	282-369	657	282-870	322
281-490	383	281-678	278	282-370	326	282-881	128
281-492	383	281-679	278	282-372	326	282-882	128
		281-681	278	282-373	326	282-883	128
281-503	132	281-683	316	282-374	326	282-884	128
281-511	338	281-684	278	282-384	322	282-885	128
281-512	338	281-685	278	282-385	322	282-886	128
281-512/281-417	338	281-686	278	282-386	322	282-887	128
281-512/281-418	338	281-687	278	282-387	322	282-888	128
281-512/281-501	338	281-687/999-950	278	282-390	322		
281-530	300			282-391	322	282-901	280
281-531	300	281-901	278	282-392	322	282-902	280
281-532	300	281-902	278			282-904	280
		281-903	278	282-402	280	282-907	280
281-610	338	281-904	278	282-405	538	282-907/999-950	280
281-611	334	281-905	278	282-409	280	282-992	280
281-611/281-417	334	281-906	278	282-415	262	282-993	280
281-611/281-418	334	281-907	278	282-422	280		
281-611/281-541	334	281-907/999-950	278	282-424	322	283 Series	
281-611/281-542	334	281-912	316	282-432	128	283-101	540
281-612	334	281-915/281-400	368	282-432/100-000	128	283-104	540
281-612/281-417	334	281-915/281-401	368	282-433	128	283-107	540
281-612/281-418	334	281-915/281-410	368	282-433/011-000	128		
281-612/281-541	334	281-915/281-411	368	282-433/100-000	128	283-301	540
281-612/281-542	334	281-916	338	282-434	128	283-302	540
281-613	336	281-992	278	282-434/100-000	128	283-322	540
281-613/281-417	336	281-993	278	282-435	128	283-325	282
281-613/281-418	336	281-994	278	282-435/011-000	128	283-326	282
281-613/281-541	336	281-998	279	282-435/300-000	128	283-328	282
281-613/281-542	336			282-435/301-000	128	283-329	282
281-616	334	282 Series		282-436	128	283-330	282
281-619	296	282-101	539	282-436/301-000	128	283-331	282
281-620	296	282-104	539	282-436/304-000	128	283-332	540
281-622	334	282-107	539	282-437	128	283-333	541
281-622/281-417	334	282-120	544	282-437/011-000	128	283-335	541
281-622/281-418	334	282-122	544	282-437/012-000	128	283-350	283
281-622/281-541	334	282-124	545	282-438	128	283-351	283
281-622/281-542	334	282-126	544	282-438/300-000	128	283-352	283
281-623	336	282-128	544	282-438/301-000	128	283-353	283
281-623/281-417	336	282-128/281-413	545	282-439	128	283-354	283
281-623/281-418	336	282-128/281-417	545	282-439/011-000	128	283-355	283
281-623/281-541	336	282-128/281-418	545	282-440	128	283-357	282
281-623/281-542	336	282-131	542	282-442	326	283-367	282
281-624	334	282-133	542	282-443	326		
281-629	296	282-135	542	282-444	326	283-400	282
281-630	296	282-137	542	282-445	326	283-402	282
281-631	279	282-138	543	282-446	326	283-404	258
281-633/281-410	372	282-139	543	282-451	544	283-405	540
281-633/281-411	372	282-140	543	282-452	544	283-407	258
281-634/281-413	372	282-141	543	282-453	544	283-409	282
281-634/281-434	372			282-454	544	283-414	282
281-635/281-489	372	282-301	539	282-457	544	283-415	282
281-635/281-490	372	282-302	539	282-458	544	283-422	282
281-635/281-491	372	282-308	280				
281-635/281-492	372	282-309	280	282-638	328	283-671	283
281-636/281-487	372	282-311	544	282-639	328	283-672	283
281-636/281-488	372	282-312	544	282-640	328	283-674	283
281-637	279	282-314	542	282-641	328	283-677	283
281-637/999-950	279	282-315	542	282-681	280	283-677/999-950	283
281-651	279	282-322	539	282-682	280		
281-652	278	282-325	280	282-684	280	283-901	282
281-653	278	282-326	280	282-687	280	283-902	282
281-654	278	282-328	280	282-687/999-950	280	283-904	282
281-656	338	282-329	280	282-694	328	283-907	282
281-657	278	282-330	280	282-695	328	283-907/999-950	282
281-657/999-950	278	282-331	280	282-696	330	283-992	282

Item Number Index

Item No.	Page	Item No.	Page	Item No.	Page	Item No.	Page
283 Series		285 Series		294 Series		294 Series	
283-998	283	285-169	264	294-4022	525	294-5113	525
		285-170	264	294-4023	525	294-5114	527
		285-172	665	294-4024	527	294-5123	525
284 Series		285-173	665	294-4025	529	294-5124	527
284-101	540	285-175	264	294-4032	525	294-5153	525
284-104	540	285-181	265	294-4035	529	294-5155	529
284-107	540	285-184	265	294-4042	525	294-5175	529
		285-187	265	294-4043	525		
284-301	540	285-188	265	294-4044	527	294-5213	527
284-302	540	285-191	264	294-4045	529	294-5214	529
284-308	281	285-194	264	294-4052	525	294-5215	529
284-309	281	285-195	264	294-4053	525	294-5223	527
284-322	540	285-197	264	294-4055	529	294-5224	529
284-325	281	285-197/999-950	264	294-4072	525	294-5225	529
284-326	281	285-199	264	294-4075	529	294-5235	529
284-328	281			294-4093/3025-000	525	294-5253	527
284-329	281	285-401	284	294-4094/4025-000	527	294-5255	529
284-330	281	285-407	264	294-4095/5025-000	529	294-5275	529
284-331	281	285-416	284	294-4095/5026-000	529		
284-332	540	285-420	258	294-4095/5027-000	529	294-5313	527
284-333	541	285-421	258			294-5314	529
284-334	273	285-427	258	294-4213	527	294-5315	530
284-336	272	285-430	258	294-4214	529	294-5323	527
284-339	281	285-435	258	294-4215	529	294-5324	529
284-340	281	285-440	262	294-4223	527	294-5325	530
284-341	281	285-441	262	294-4224	529	294-5335	530
284-342	281	285-442	258	294-4225	529	294-5353	527
284-343	541	285-447	262	294-4235	529	294-5355	530
284-344	273	285-448	263	294-4253	527	294-5375	530
284-346	272	285-449	262	294-4255	529		
284-357	281	285-450	262	294-4275	529	294-5413	527
284-358	281	285-495	264			294-5414	527
284-367	281			294-4313	527	294-5415	529
284-368	281	285-634	284	294-4314	529	294-5423	527
		285-635	284	294-4315	530	294-5424	527
284-400	281	285-637	284	294-4323	527	294-5425	529
284-402	281	285-637/999-950	284	294-4324	529	294-5435	529
284-405	540			294-4325	530	294-5453	527
284-409	281	285-935	258	294-4335	530	294-5455	529
284-412	285	285-950	262	294-4353	527	294-5475	529
284-413	279	285-992	284	294-4355	530		
284-414	273	285-995	264	294-4375	530	709 Series	
284-415	264					709-107	550
284-422	281	285-1161	267	294-4413	527	709-110	323
		285-1163	267	294-4414	527	709-111	323
284-621	285	285-1164	267	294-4415	529	709-112	323
284-624	285	285-1165	267	294-4423	527	709-118	649
284-681	281	285-1167	267	294-4424	527	709-119	649
284-682	281	285-1167/999-950	267	294-4425	529	709-120	649
284-684	281	285-1169	266	294-4435	529	709-153	661
284-687	281	285-1171	266	294-4453	527	709-154	661
284-687/999-950	281	285-1175	266	294-4455	529	709-156	662
		285-1176	266	294-4475	529	709-167	661
284-901	281	285-1177	266			709-168	661
284-902	281	285-1178	266	294-5002	525	709-169	662
284-904	281	285-1179	267	294-5003	525	709-170	315
284-907	281	285-1181	266	294-5004	527	709-177	300
284-907/999-950	281	285-1184	266	294-5005	529	709-178	516
284-992	281	285-1185	266	294-5012	525	709-183	661
284-993	281	285-1187	266	294-5013	525	709-193	649
		285-1187/999-950	266	294-5014	527	709-196	471
		285-1189	266	294-5015	529		
285 Series		294 Series		294-5022	525	709-310	381
285-131	258	294-199	531	294-5023	525	709-311	381
285-134	258			294-5024	527	709-312	381
285-135	258	294-364	531	294-5025	529	709-322	381
285-137	258	294-370	531	294-5032	525	709-324	381
285-137/999-950	258	294-375	531	294-5035	529	709-326	381
285-139	258	294-384	531	294-5042	525	709-332	381
285-141	263			294-5043	525	709-334	381
285-143	263	294-4002	525	294-5044	527	709-336	381
285-144	263	294-4003	525	294-5045	529	709-350	628
285-147	263	294-4004	527	294-5052	525	709-352	628
285-148	263	294-4005	529	294-5053	525		
285-150	262	294-4006	530	294-5055	529	709-581	654
285-151	262	294-4007	530	294-5072	525	709-582	654
285-154	262	294-4012	525	294-5075	529	709-583	654
285-157	262	294-4013	525	294-5094/4025-000	527	709-591	655
285-157/999-950	262	294-4014	527	294-5095/5025-000	529		
285-159	262	294-4015	529	294-5095/5026-000	529	726 Series	
285-168	265			294-5095/5027-000	529	726-121	550

Item No.	Page	Item No.	Page	Item No.	Page	Item No.	Page
726 Series		727 Series		769 Series		769 Series	
726-122	550	727-133	564	769-102	444	769-114/000-036	450
726-141	550	727-134	564	769-102/021-000	445	769-114/000-037	450
726-142	550	727-135	565	769-102/022-000	447	769-114/000-038	450
		727-136	565	769-103	444	769-114/000-039	451
726-221	550	727-137	565	769-103/000-036	450	769-114/021-000	445
726-222	550	727-138	565	769-103/000-037	450	769-114/022-000	447
726-241	550	727-155	564	769-103/000-038	450	769-115	444
726-242	550	727-155	565	769-103/000-039	451	769-115/000-036	450
		727-156	564	769-103/021-000	445	769-115/000-037	450
		727-157	564	769-103/022-000	447	769-115/000-038	450
726-321	553	727-158	564	769-104	444	769-115/000-039	451
726-322	553	727-159	564	769-104/000-036	450	769-115/021-000	445
726-325	553	727-160	564	769-104/000-037	450	769-115/022-000	447
726-326	553	727-161	564	769-104/000-038	450	769-121	446
726-341	553	727-162	564	769-104/000-039	451	769-121/000-016	446
726-342	553	727-163	564	769-104/021-000	445	769-122	446
726-345	553	727-164	564	769-104/022-000	447	769-123	446
726-346	553	727-165	564	769-105	444	769-124	446
		727-166	564	769-105/000-036	450	769-125	446
726-421	551	727-167	564	769-105/000-037	450	769-126	446
726-441	551	727-168	564	769-105/000-038	450	769-127	446
		727-169	564	769-105/000-039	451	769-128	446
726-521	551	727-170	564	769-105/021-000	445	769-129	446
726-541	551	727-197	562	769-105/022-000	447	769-130	446
		727-198	562	769-106	444	769-131	446
726-601	554	727-199	562	769-106/000-036	450	769-132	446
726-602	554			769-106/000-037	450	769-133	446
726-611	554	727-205	562	769-106/000-038	450	769-134	446
726-612	554	727-206	562	769-106/000-039	451	769-135	446
726-621	554	727-207	562	769-106/021-000	445	769-151	400
726-622	554	727-208	562	769-106/022-000	447	769-156	396
726-631	555	727-213	562	769-107	444	769-156/000-006	396
726-632	555	727-214	562	769-107/000-036	450	769-161	418
726-651	556	727-217	562	769-107/000-037	450	769-162/769-313	418
726-652	556	727-219	562	769-107/000-038	450	769-163/769-313	418
726-661	556	727-220	562	769-107/000-039	451	769-164/769-313	418
726-662	556	727-221	562	769-107/021-000	445	769-165/769-313	418
726-671	556	727-222	562	769-107/022-000	447	769-171	398
726-672	556	727-223	562	769-108	444	769-171/000-006	398
		727-224	562	769-108/000-036	450	769-176	394
726-721	552	727-225	563	769-108/000-037	450	769-176/000-006	394
726-741	552	727-226	563	769-108/000-038	450	769-176/000-012	394
726-770	557	727-227	563	769-108/000-039	451	769-181	416
726-771	557	727-228	563	769-108/021-000	445	769-182/769-314	416
726-780	557	727-229	562	769-108/022-000	447	769-183/769-314	416
		727-230	562	769-109	444	769-184/769-314	416
726-800	557	727-231	562	769-109/000-036	450	769-185/769-314	416
726-801	557	727-232	562	769-109/000-037	450	769-191	420
726-821	552	727-233	562	769-109/000-038	450	769-192/769-319	420
726-841	552	727-234	562	769-109/000-039	451	769-193/769-319	420
		727-235	563	769-109/021-000	445	769-194/769-319	420
726-901	559	727-236	563	769-109/022-000	447	769-195/769-319	420
726-902	550	727-237	563	769-110	444		
726-903	558	727-238	563	769-110/000-036	450	769-201	400
726-904	558	727-255	562	769-110/000-037	450	769-202	407
726-906	559	727-255	563	769-110/000-038	450	769-203	407
726-907	559	727-256	562	769-110/000-039	451	769-207	400
		727-257	562	769-110/021-000	445	769-208/281-410	409
727 Series		727-258	562	769-110/022-000	447	769-208/281-411	409
727-105	564	727-265	562	769-111	444	769-209/281-413	411
727-106	564	727-266	562	769-111/000-036	450	769-209/281-434	411
727-107	564	727-267	562	769-111/000-037	450	769-211	398
727-108	564	727-268	562	769-111/000-038	450	769-212	407
727-113	564			769-111/000-039	451	769-213	407
727-114	564			769-111/021-000	445	769-214	404
727-115	564			769-111/022-000	447	769-217	398
727-116	564	734 Series		769-112	444	769-218/281-410	409
727-117	564	734-326	168	769-112/000-036	450	769-218/281-411	409
727-119	564	734-327	168	769-112/000-037	450	769-219/281-413	411
727-120	564	734-328	168	769-112/000-038	450	769-219/281-434	411
727-121	564	734-329	168	769-112/000-039	451	769-221	396
727-122	564			769-112/021-000	445	769-222	406
727-123	564	734-430	208	769-112/022-000	447	769-223	406
727-124	564	734-431	208	769-113	444	769-227	396
727-125	565			769-113/000-036	450	769-228/281-410	408
727-126	565	769 Series		769-113/000-037	450	769-228/281-411	408
727-127	565	769-101	444	769-113/000-038	450	769-229/281-413	410
727-128	565	769-101/000-006	444	769-113/000-039	451	769-229/281-434	410
727-129	564	769-101/000-016	444	769-113/021-000	445	769-231	394
727-130	564	769-101/022-000	447	769-113/022-000	447	769-232	406
727-131	564	769-101/022-016	447	769-114	444	769-233	406
727-132	564						

Item Number Index

Item No.	Page	Item No.	Page	Item No.	Page	Item No.	Page
769 Series		769 Series		769 Series		769 Series	
769-237	394	769-602	434	769-615/004-000	435	769-666/003-000	439
769-238/281-410	408	769-602/001-000	434	769-615/005-000	436	769-666/004-000	440
769-238/281-411	408	769-602/002-000	434	769-615/006-000	437	769-667	438
769-239/281-413	410	769-602/004-000	435	769-632	438	769-667/003-000	439
769-239/281-434	410	769-602/005-000	436	769-632/000-036	438	769-667/004-000	440
769-242	414	769-602/006-000	437	769-632/003-000	439	769-668	438
769-243	414	769-603	434	769-632/003-036	439	769-668/003-000	439
769-251	402	769-603/001-000	434	769-632/004-000	440	769-668/004-000	440
769-251/000-006	402	769-603/002-000	434	769-632/007-000	442	769-669	438
769-257	402	769-603/004-000	435	769-633	438	769-669/003-000	439
		769-603/005-000	436	769-633/000-036	438	769-669/004-000	440
769-301	400	769-603/006-000	437	769-633/003-000	439	769-670	438
769-302	400	769-604	434	769-633/003-036	439	769-670/003-000	439
769-303	398	769-604/001-000	434	769-633/004-000	440	769-670/004-000	440
769-304	398	769-604/002-000	434	769-633/007-000	442	769-671	438
769-305	396	769-604/004-000	435	769-634	438	769-671/003-000	439
769-306	396	769-604/005-000	436	769-634/000-036	438	769-671/004-000	440
769-307	394	769-604/006-000	437	769-634/003-000	439	769-672	438
769-308	394	769-605	434	769-634/003-036	439	769-672/003-000	439
769-309	407	769-605/001-000	434	769-634/004-000	440	769-672/004-000	440
769-310	407	769-605/002-000	434	769-634/007-000	442	769-673	438
769-311	407	769-605/004-000	435	769-635	438	769-673/003-000	439
769-312	407	769-605/005-000	436	769-635/000-036	438	769-673/004-000	440
769-313	407	769-605/006-000	437	769-635/003-000	439	769-674	438
769-314	407	769-606	434	769-635/003-036	439	769-674/003-000	439
769-315	404	769-606/001-000	434	769-635/004-000	440	769-674/004-000	440
769-316	404	769-606/002-000	434	769-635/007-000	442	769-675	438
769-317	414	769-606/004-000	435	769-636	438	769-675/003-000	439
769-318	414	769-606/005-000	436	769-636/003-000	439	769-675/004-000	440
769-319	414	769-606/006-000	437	769-636/003-036	439		
769-320	402	769-607	434	769-636/004-000	440	769-1602	452
769-321	402	769-607/001-000	434	769-636/007-000	442	769-1603	452
		769-607/002-000	434	769-637	438	769-1604	452
		769-607/004-000	435	769-637/003-000	439	769-1605	452
769-402	444	769-607/005-000	436	769-637/004-000	440	769-1606	452
769-410	258	769-607/006-000	437	769-637/007-000	442	769-1607	452
769-411	434	769-608	434	769-638	438	769-1608	452
769-412	434	769-608/001-000	434	769-638/003-000	439	769-1609	452
769-413	434	769-608/002-000	434	769-638/004-000	440	769-1610	452
769-414	434	769-608/004-000	435	769-638/007-000	442	769-1611	452
769-428	444	769-608/005-000	436	769-639	438	769-1612	452
769-429	444	769-608/006-000	437	769-639/003-000	439	769-1613	452
769-430	444	769-609	434	769-639/004-000	440	769-1614	452
769-431	444	769-609/001-000	434	769-639/007-000	442	769-1615	452
769-434	435	769-609/002-000	434	769-640	438		
769-435	394	769-609/004-000	435	769-640/003-000	439	773 Series	
769-436	444	769-609/005-000	436	769-640/004-000	440	773-173	577
769-438	394	769-609/006-000	437	769-641	438		
769-439	394	769-610	434	769-641/003-000	439	773-331	579
769-470	394	769-610/001-000	434	769-641/004-000	440	773-332	575
769-471	394	769-610/002-000	434	769-641/007-000	442		
769-472	394	769-610/004-000	435	769-642	438	773-492	578
769-499	434	769-610/005-000	436	769-642/003-000	439	773-493	578
		769-610/006-000	437	769-642/004-000	440	773-494	578
769-501	448	769-611	434	769-642/007-000	442	773-496	578
769-501/000-006	448	769-611/001-000	434	769-643	438	773-498	578
769-501/000-016	448	769-611/002-000	434	769-643/003-000	439		
769-502	448	769-611/004-000	435	769-643/004-000	440	773-514	577
769-502/000-006	448	769-611/005-000	436	769-643/007-000	442		
769-502/000-016	448	769-612	434	769-644	438	773-602	576
769-503	448	769-612/001-000	434	769-644/003-000	439	773-604	576
769-503/000-006	448	769-612/002-000	434	769-644/004-000	440	773-606	576
769-503/000-016	448	769-612/004-000	435	769-644/007-000	442		
769-504	448	769-612/005-000	436	769-645	438	777 Series	
769-504/000-006	448	769-612/006-000	437	769-645/003-000	439	777-300	307
769-504/000-016	448	769-613	434	769-645/004-000	440	777-303	228
769-505	448	769-613/001-000	434	769-645/007-000	442	777-305	305
769-505/000-006	448	769-613/002-000	434	769-662	438	777-310	303
769-505/000-016	448	769-613/004-000	435	769-662/003-000	439		
769-506	448	769-613/005-000	436	769-662/004-000	440	780 Series	
769-506/000-006	448	769-613/006-000	437	769-663	438	780-317	303
769-506/000-016	448	769-614	434	769-663/003-000	439	780-321	307
769-512	448	769-614/001-000	434	769-663/004-000	440		
769-512/000-006	448	769-614/002-000	434	769-664	438	780-452	384
769-512/000-016	448	769-614/004-000	435	769-664/003-000	439	780-453	384
769-513	448	769-614/005-000	436	769-664/004-000	440	780-454	384
769-513/000-006	448	769-614/006-000	437	769-665	438	780-455	384
769-513/000-016	448	769-615	434	769-665/003-000	439	780-456	384
769-515	448	769-615/001-000	434	769-665/004-000	440	780-457	384
769-515/000-006	448	769-615/002-000	434	769-666	438	780-458	384
769-515/000-016	448						

Item No.	Page	Item No.	Page	Item No.	Page	Item No.	Page
780 Series		785 Series		793 Series		859 Series	
780-601	303	785-604	306	793-5501/000-012	640	859-500	186
780-602	303	785-607	306	793-5501/000-017	640		
780-604	303	785-613	309	793-5501/000-023	640		
780-607	303	785-623	309	793-5501/000-024	640	862 Series	
780-607/999-950	303	790 Series		793-5502	550	862-482	516
780-613	307	790-100	624	793-5566	550		
780-631	303	790-101	624	794 Series		862-503	517
780-637	303	790-108	624	794-4615	294	862-504	518
780-637/999-950	303	790-110	624	794-4616	294	862-505	519
780-640	303	790-112	624	794-4617	294	862-515	519
780-651	303	790-113	624	794-4618	294	862-525	519
780-654	303	790-114	624	794-4619	294	862-532	516
		790-115	624			862-533	517
780-992	303	790-116	624	794-5553/000-002	128	862-534	518
780-993	303	790-124	624	794-5554/000-006	128	862-552	516
		790-124	624			862-562	516
		790-133	624	794-5615	132	862-593	517
781 Series		790-134	624	794-5616	132	862-594	518
781-452	384	790-140	625	794-5617	132	862-603	517
781-453	384	790-144	624	794-5618	132	862-604	518
781-454	384	790-145	624	794-5619	132	862-605	519
781-455	384	790-190	624	811 Series		862-615	519
781-456	384	790-191	624	811-310	342	862-625	519
		790-192	624	811-311	342	862-632	516
781-601	304	790-193	624	811-314	342	862-633	517
781-604	304			811-316	342	862-634	518
781-607	304	790-208	627	811-317	342	862-652	516
781-607/999-950	304	790-216	627	811-320	342	862-662	516
781-613	307	790-220	627	811-321	342	862-693	517
781-623	307			811-330	342	862-694	518
781-631	304	790-300	630	811-331	342		
781-637	304	790-301	630			862-1503	517
781-637/999-950	304	790-302	630	811-410	342	862-1503/999-950	517
781-643	307	790-310	631	811-411	342	862-1504	518
781-651	304	790-311	631	811-414	342	862-1504/999-950	518
781-653	307	790-312	631	811-414	342	862-1505	519
		790-350/790-398	632	811-420	342	862-1505/999-950	519
781-992	304	790-352/790-398	632	811-421	342	862-1515	519
781-993	304	790-360/790-398	632	811-430	342	862-1515/999-950	519
		790-362/790-398	632	811-431	342	862-1525	519
		790-398	632	811-471	342	862-1525/999-950	519
782 Series		790-400	629	811-472	343	862-1532	516
782-300	308	791 Series		811-473	343	862-1532/999-950	516
782-317	305	791-107	628	811-474	343	862-1533	517
782-321	308	791-111	628	811-475	343	862-1533/999-950	517
		791-117	628	811-476	343	862-1534	518
782-601	305	791-124	628	811-477	343	862-1534/999-950	518
782-604	305	793 Series		811-478	343	862-1552	516
782-607	305	793-501	640	811-479	343	862-1552/999-950	516
782-607/999-950	305	793-501/000-002	640	811-480	343	862-1562	516
782-613	308	793-501/000-005	640	811-481	343	862-1562/999-950	516
782-623	308	793-501/000-006	640	811-482	343	862-1593	517
		793-501/000-007	640			862-1593/999-950	517
782-992	305	793-501/000-012	640	811-612	342	862-1594	518
		793-501/000-017	640			862-1594/999-950	518
783 Series		793-501/000-023	640	812 Series		862-1603	517
783-317	306	793-501/000-024	640	812-100	569	862-1603/999-950	517
783-321	308			812-101	569	862-1604	518
		793-933	564	812-102	569	862-1604/999-950	518
783-601	306			812-103	569	862-1605	519
783-604	306	793-3501	640	812-104	569	862-1605/999-950	519
783-607	306			812-110	569	862-1615	519
783-607/999-950	306	793-4501	640	812-111	569	862-1615/999-950	519
783-613	308	793-4501/000-002	640	812-112	569	862-1625	519
783-623	308	793-4501/000-005	640	812-113	569	862-1625/999-950	519
		793-4501/000-006	640	812-114	569	862-1632	516
783-992	306	793-4501/000-007	640	812-140	569	862-1632/999-950	516
		793-4501/000-012	640	812-141	569	862-1633	517
784 Series		793-4501/000-017	640			862-1633/999-950	517
784-601	305	793-4501/000-023	640	821 Series		862-1634	518
784-604	305	793-4501/000-024	640	821-104	243	862-1634/999-950	518
784-607	305			821-120	243	862-1652	516
784-607/999-950	305	793-5501	640	821-122	243	862-1652/999-950	516
784-613	308	793-5501/000-002	640	821-123	243	862-1662	516
784-623	308	793-5501/000-005	640	821-129	243	862-1662/999-950	516
		793-5501/000-006	640	821-153	69	862-1693	517
784-992	305	793-5501/000-007	640	821-154	69	862-1693/999-950	517
				821-155	69	862-1694	518
785 Series						862-1694/999-950	518
785-601	306						

Item Number Index

Item No.	Page	Item No.	Page	Item No.	Page	Item No.	Page
862 Series		869 Series		869 Series		870 Series	
862-2503	517	869-134	485	869-359	486	870-535	469
862-2504	518	869-135	485	869-375	486	870-536	469
862-2505	519	869-136	485	869-377	486	870-537	469
862-2515	519	869-137	485	869-378	486	870-538	469
862-2525	519	869-138	485	869-379	486	870-539	469
862-2532	516	869-139	485	869-385	486	870-540/281-410	472
862-2533	517	869-140	485	869-387	486	870-540/281-411	472
862-2534	518	869-141	485	869-388	486	870-541/281-489	472
862-2552	516	869-142	485	869-389	486	870-541/281-490	472
862-2562	516	869-152	485	869-395	486	870-541/281-491	472
862-2593	517	869-153	485	869-397	486	870-541/281-492	472
862-2594	518	869-154	485	869-398	486	870-542/281-487	472
		869-155	485	869-399	486	870-542/281-488	472
862-2603	517	869-156	485			870-543/281-413	472
862-2604	518	869-157	485			870-543/281-434	472
862-2605	519	869-158	485	870 Series		870-551	470
862-2615	519	869-159	485	870-101	424	870-553	470
862-2625	519	869-160	485	870-102	424	870-556	470
862-2632	516	869-161	485	870-103	424	870-557	470
862-2633	517	869-162	485	870-104	424	870-558	470
862-2634	518	869-182	485	870-107	424	870-559	470
862-2652	516	869-183	485	870-108	424	870-567	470
862-2662	516	869-184	485	870-109	424	870-568	470
862-2693	517	869-185	485	870-117	424	870-569	470
862-2694	518	869-186	485	870-118	424	870-573	469
		869-187	485	870-119	424	870-574	469
862-8503	517	869-188	485	870-127	424	870-574/281-483	479
862-8504	518	869-189	485	870-131	430	870-577	470
862-8505	519	869-190	485	870-137	430	870-590/281-410	474
862-8515	519	869-191	485	870-138	430	870-590/281-411	474
862-8525	519	869-192	485	870-148	430	870-590/281-675	474
862-8533	517			870-149	430	870-590/281-676	474
862-8534	518	869-202	485	870-151	428	870-593/281-413	474
862-8593	517	869-203	485	870-157	428	870-593/281-434	474
862-8594	518	869-204	485	870-158	428	870-596/281-673	474
		869-205	485	870-168	428	870-596/281-674	474
862-8603	517	869-206	485	870-169	428		
862-8604	518	869-207	485	870-182	471	870-681	466
862-8605	519	869-208	485	870-183	471	870-682	466
862-8615	519	869-209	485	870-184	471	870-684	466
862-8625	519	869-210	485			870-687	466
862-8633	517	869-211	485	870-402	424		
862-8634	518	869-212	485	870-403	424	870-826	467
862-8693	517	869-232	485	870-404	424	870-831	466
862-8694	518	869-233	485	870-405	424	870-832	466
		869-234	485	870-405/011-000	471	870-834	466
862-9503	517	869-235	485	870-406	424	870-837	466
862-9504	518	869-236	485	870-406/020-000	471		
862-9505	519	869-237	485	870-407	424	870-901	466
862-9515	519	869-238	485	870-407/011-000	471	870-902	466
862-9525	519	869-239	485	870-408	424	870-904	466
862-9533	517	869-240	485	870-409	424	870-907	466
862-9534	518	869-241	485	870-409/011-000	471	870-907/999-950	466
862-9593	517	869-242	485	870-410	424	870-909	466
862-9594	518			870-425	477	870-911	467
		869-301	486	870-426	477	870-912	467
862-9603	517	869-304	486	870-427	477	870-914	467
862-9604	518	869-307	486	870-433	424	870-917	467
862-9605	519	869-309	486	870-434	424	870-917/999-950	467
862-9615	519	869-311	487	870-435	424	870-919	467
862-9625	519	869-314	487	870-436	424	870-923	466
862-9633	517	869-316	487	870-437	424	870-924	466
862-9634	518	869-317	487	870-438	424	870-925	466
862-9693	517	869-319	487	870-439	424	870-926	466
862-9694	518	869-321	486	870-440	424	870-928	466
		869-324	486			870-929	466
		869-326	486	870-501	468	870-933	466
869 Series		869-327	486	870-502	468	870-934	466
869-102	485	869-328	486	870-503	468	870-943	466
869-103	485	869-329	486	870-504	468	870-944	466
869-104	485	869-331	486	870-507	468	870-946	466
869-105	485	869-334	486	870-508	468	870-947	466
869-106	485	869-337	486	870-509	468	870-948	466
869-107	485	869-339	486	870-517	468	870-949	466
869-108	485	869-341	486	870-518	468	870-951	470
869-109	485	869-344	486	870-519	468	870-957/999-950	470
869-110	485	869-347	486	870-527	468	870-961	468
869-111	485	869-349	486	870-531	469	870-967/999-950	468
869-112	485	869-351	486	870-532	469		
869-132	485	869-354	486	870-533	469	870-1131	426
869-133	485	869-357	486	870-534	469	870-1137	426

Item No.	Page	Item No.	Page	Item No.	Page	Item No.	Page
870 Series		2000 Series		2000 Series		2001 Series	
870-1138	426	2000-559	168	2000-2292	73	2001-1301	56
870-1148	426	2000-560	168			2001-1302	56
870-1149	426			2000-5310/101-000	141	2001-1303	56
		2000-1201	54	2000-5310/102-000	141	2001-1304	56
		2000-1202	54	2000-5310/1101-951	141	2001-1305	56
873 Series		2000-1203	54	2000-5310/1102-950	141	2001-1306	56
873-902	618	2000-1204	54	2000-5311	138	2001-1307	56
873-903	618	2000-1205	54	2000-5311/1101-951	138	2001-1308	56
873-953	619	2000-1206	54	2000-5311/1102-950	138	2001-1311/1000-410	146
		2000-1207	54	2000-5317/101-000	140	2001-1311/1000-411	146
		2000-1291	38	2000-5317/102-000	140	2001-1321/1000-413	146
		2000-1292	38	2000-5317/1101-951	140	2001-1321/1000-434	146
				2000-5317/1102-950	140		
887 Series		2000-1301	54	2000-5352	138	2001-1401	56
887-802	616	2000-1302	54	2000-5352/1102-953	138	2001-1402	56
887-910	614	2000-1303	54	2000-5357/101-000	140	2001-1403	56
887-912	614	2000-1304	54	2000-5357/102-000	140	2001-1404	56
887-925	614	2000-1305	54	2000-5372	138	2001-1405	56
887-926	615	2000-1306	54	2000-5372/1102-953	138	2001-1406	56
887-927	615	2000-1307	54	2000-5377/101-000	140	2001-1407	56
887-928	614	2000-1391	38	2000-5377/102-000	140	2001-1408	56
887-931	615	2000-1392	38	2000-5391	138	2001-1411/1000-410	146
887-952	616					2001-1411/1000-411	146
887-953	616	2000-1401	54	2000-5410	141	2001-1421/1000-413	146
887-955	617	2000-1402	54	2000-5410/1101-951	141	2001-1421/1000-434	146
887-957	617	2000-1403	54	2000-5410/1102-950	141	2001-1441	57
887-959	617	2000-1404	54	2000-5417	139		
887-960	616	2000-1405	54	2000-5417/1101-951	139	2002 Series	
		2000-1406	54	2000-5417/1102-950	139	2002-115	28
2000 Series		2000-1407	54	2000-5457	139	2002-116	156
2000-115	54	2000-1491	38	2000-5457/1102-953	139	2002-121	647
2000-121	647	2000-1492	38	2000-5477	139	2002-131	647
				2000-5477/1102-953	139	2002-160	646
2000-402	38	2000-2141	55	2000-5491	139	2002-161	646
2000-402/000-005	174	2000-2195	55	2001 Series		2002-171	28
2000-402/000-006	174	2000-2196	55	2001-115	56	2002-172	28
2000-402/000-018	174			2001-171	40	2002-191	181
2000-403	38	2000-2201	72			2002-192	181
2000-403/000-005	174	2000-2201/099-000	74	2001-402	40	2002-194	181
2000-403/000-006	174	2000-2202	72	2001-403	40	2002-400	175
2000-404	38	2000-2202/099-000	74	2001-404	40	2002-401	180
2000-404/000-005	174	2000-2203	72	2001-405	40	2002-402	28
2000-404/000-006	174	2000-2203/099-000	74	2001-405/011-000	177	2002-402/000-005	174
2000-405	38	2000-2204	72	2001-406	40	2002-402/000-006	174
2000-405/000-005	174	2000-2204/099-0003	74	2001-406/020-000	177	2002-403	28
2000-405/000-006	174	2000-2207	72	2001-407	40	2002-403/000-005	174
2000-405/011-000	177	2000-2207/099-000	74	2001-408	40	2002-403/000-006	174
2000-406	38	2000-2208	72	2001-409	40	2002-404	28
2000-406/000-005	174	2000-2208/099-000	74	2001-410	40	2002-404/000-005	174
2000-406/000-006	174	2000-2209	72	2001-433	40	2002-404/000-006	174
2000-406/020-000	177	2000-2217	72	2001-434	40	2002-405	28
2000-407	38	2000-2218	73	2001-435	40	2002-405/000-005	174
2000-407/000-005	174	2000-2218/099-000	75	2001-436	40	2002-405/000-006	174
2000-407/000-006	174	2000-2227	72	2001-437	40	2002-405/011-000	177
2000-408	38	2000-2227/099-000	74	2001-438	40	2002-406	28
2000-408/000-005	174	2000-2228	73	2001-439	40	2002-406/000-005	174
2000-408/000-006	174	2000-2228/099-000	75	2001-440	40	2002-406/000-006	174
2000-409	38	2000-2231	72			2002-406/020-000	177
2000-409/000-005	174	2000-2231/099-000	74	2001-511	168	2002-407	28
2000-409/000-006	174	2000-2232	72	2001-552	168	2002-407/000-005	174
2000-410	38	2000-2232/099-000	74	2001-553	168	2002-407/000-006	174
2000-410/000-005	174	2000-2233	72	2001-554	168	2002-408	28
2000-410/000-006	174	2000-2233/099-000	74	2001-555	168	2002-408/000-005	174
2000-433	38	2000-2234	72	2001-556	168	2002-408/000-006	174
2000-434	38	2000-2234/099-0003	74	2001-557	168	2002-409	28
2000-435	38	2000-2237	72	2001-558	168	2002-409/000-005	174
2000-436	38	2000-2237/099-000	74	2001-559	168	2002-409/000-006	174
2000-437	38	2000-2238	72	2001-560	168	2002-410	28
2000-438	38	2000-2238/099-000	74			2002-410/000-005	174
2000-439	38	2000-2239	72	2001-1201	56	2002-410/000-006	174
2000-440	38	2000-2239/099-0003	74	2001-1202	56	2002-423	175
2000-492	179	2000-2247	72	2001-1203	56	2002-423/000-005	175
		2000-2247/099-000	74	2001-1204	56	2002-423/000-006	175
2000-510	168	2000-2248	73	2001-1205	56	2002-433	28
2000-511	168	2000-2248/099-000	75	2001-1206	56	2002-434	28
2000-549	168	2000-2257	72	2001-1207	56	2002-435	28
2000-552	168	2000-2257/099-000	74	2001-1208	56	2002-436	28
2000-553	168	2000-2258	73	2001-1211/1000-410	146	2002-437	28
2000-554	168	2000-2258/099-000	75	2001-1211/1000-411	146	2002-438	28
2000-555	168	2000-2291	73			2002-439	28
2000-556	168						
2000-557	168						
2000-558	168						

Item Number Index

Item No.	Page	Item No.	Page	Item No.	Page	Item No.	Page
2002 Series		2002 Series		2002 Series		2002 Series	
2002-440	28	2002-1311/1000-410	148	2002-1881	108	2002-2247/099-000	78
2002-472	176	2002-1311/1000-411	148	2002-1891	96	2002-2248	77
2002-473	176	2002-1321/1000-413	148	2002-1892	96	2002-2248/099-000	79
2002-473/011-000	176	2002-1321/1000-434	148			2002-2257	76
2002-474	176	2002-1391	40	2002-1901	111	2002-2257/099-000	78
2002-475	176	2002-1392	40	2002-1902	111	2002-2258	77
2002-475/011-000	176	2002-1393	40	2002-1904	111	2002-2258/099-000	79
2002-476	176	2002-1394	40	2002-1907	111	2002-2291	77
2002-477	176			2002-1911	114	2002-2292	77
2002-477/011-000	176	2002-1401	58	2002-1911/1000-541	114	2002-2295	77
2002-478	176	2002-1402	58	2002-1911/1000-542	114	2002-2296	77
2002-479	176	2002-1403	58	2002-1911/1000-836	114		
2002-479/011-000	176	2002-1404	58	2002-1911/1000-867	114	2002-2401	82
2002-480	176	2002-1405	58	2002-1961	111	2002-2402	82
2002-481	176	2002-1406	58	2002-1971	110	2002-2403	82
2002-481/011-000	176	2002-1407	58	2002-1971/401-000	110	2002-2404	82
2002-482	176	2002-1408	58	2002-1972	110	2002-2407	82
2002-492	179	2002-1411/1000-410	148	2002-1972/401-000	110	2002-2408	82
2002-492/000-012	179	2002-1411/1000-411	148	2002-1974	110	2002-2409	82
2002-493	179	2002-1421/1000-413	148	2002-1974/401-000	110	2002-2417	82
		2002-1421/1000-434	148	2002-1981	113	2002-2418	83
2002-511	169	2002-1441	59	2002-1981/1000-413	112	2002-2427	82
2002-541	168	2002-1491	40	2002-1981/1000-414	112	2002-2428	83
2002-549	169	2002-1492	40	2002-1981/1000-429	112	2002-2431	82
2002-552	169	2002-1493	40	2002-1981/1000-434	112	2002-2432	82
2002-553	169	2002-1494	40	2002-1981/1000-435	112	2002-2433	82
2002-554	169			2002-1981/1000-449	112	2002-2434	82
2002-555	169	2002-1601	105	2002-1991	98	2002-2437	82
2002-556	169	2002-1602	105	2002-1992	98	2002-2438	82
2002-557	169	2002-1604	105			2002-2439	82
2002-558	169	2002-1611	114	2002-2201	76	2002-2447	82
2002-559	169	2002-1611/1000-541	114	2002-2201/097-000	80	2002-2448	83
2002-560	169	2002-1611/1000-542	114	2002-2201/098-000	80	2002-2457	82
		2002-1611/1000-836	114	2002-2201/099-000	78	2002-2458	83
2002-611	172	2002-1611/1000-867	114	2002-2202	76	2002-2491	83
2002-641	172	2002-1661	105	2002-2202/099-000	78	2002-2492	83
2002-649	172	2002-1671	104	2002-2203	76		
		2002-1671/401-000	104	2002-2203/099-000	78	2002-2601	84
2002-800	156	2002-1672	104	2002-2204	76	2002-2602	84
2002-800/1000-410	152	2002-1672/401-000	104	2002-2204/099-000	78	2002-2603	84
2002-800/1000-411	152	2002-1674	104	2002-2206	76	2002-2604	84
2002-800/1000-541	154	2002-1674/401-000	104	2002-2207	76	2002-2607	84
2002-800/1000-542	154	2002-1681	104	2002-2207/099-000	78	2002-2608	84
2002-800/1000-836	154	2002-1691	92	2002-2208	76	2002-2609	84
2002-810	156	2002-1692	92	2002-2208/099-000	78	2002-2611	87
2002-820	156			2002-2209	76	2002-2611/1000-541	87
2002-880	153	2002-1701	107	2002-2209/099-000	78	2002-2611/1000-542	87
2002-880/1000-411	153	2002-1702	107	2002-2211/1000-410	164	2002-2611/1000-836	87
2002-880/1000-541	155	2002-1704	107	2002-2211/1000-411	164	2002-2611/1000-867	87
2002-880/1000-542	155	2002-1707	107	2002-2213/1000-487	164	2002-2612	87
2002-880/1000-836	155	2002-1711	114	2002-2213/1000-488	164	2002-2647	84
		2002-1711/1000-541	114	2002-2214/1000-489	164	2002-2657	84
2002-991	102	2002-1711/1000-542	114	2002-2214/1000-490	164	2002-2661	86
2002-992	102	2002-1711/1000-836	114	2002-2214/1000-491	164	2002-2662	86
		2002-1711/1000-867	114	2002-2214/1000-492	164	2002-2667	86
2002-1091	87	2002-1761	107	2002-2214/1000-980	164	2002-2671	86
2002-1092	87	2002-1771	106	2002-2217	76	2002-2672	86
		2002-1771/401-000	106	2002-2217/099-000	78	2002-2678	86
2002-1201	58	2002-1772	106	2002-2218	77	2002-2691	85
2002-1202	58	2002-1772/401-000	106	2002-2218/099-000	79	2002-2692	85
2002-1203	58	2002-1774	106	2002-2221/1000-413	164		
2002-1204	58	2002-1774/401-000	106	2002-2221/1000-434	164	2002-2701	81
2002-1205	58	2002-1781	106	2002-2227	76	2002-2702	81
2002-1206	58	2002-1791	94	2002-2227/099-000	78	2002-2703	81
2002-1207	58	2002-1792	94	2002-2228	77	2002-2704	81
2002-1208	58			2002-2228/099-000	79	2002-2707	81
2002-1211/1000-410	148	2002-1801	109	2002-2231	76	2002-2707/999-950	81
2002-1211/1000-411	148	2002-1802	109	2002-2231/099-000	78	2002-2708	81
2002-1291	40	2002-1804	109	2002-2232	76	2002-2709	81
2002-1292	40	2002-1811	115	2002-2232/099-000	78	2002-2717	81
2002-1293	40	2002-1811/1000-541	115	2002-2233	76	2002-2727	81
2002-1294	40	2002-1811/1000-542	115	2002-2233/099-000	78	2002-2791	70
		2002-1811/1000-836	115	2002-2234	76	2002-2792	70
2002-1301	58	2002-1811/1000-867	115	2002-2234/099-000	78		
2002-1302	58	2002-1861	109	2002-2237	76	2002-2941	162
2002-1303	58	2002-1871	108	2002-2237/099-000	78	2002-2951	160
2002-1304	58	2002-1871/401-000	108	2002-2238	76	2002-2952	160
2002-1305	58	2002-1872	108	2002-2238/099-000	78	2002-2954	160
2002-1306	58	2002-1872/401-000	108	2002-2239	76	2002-2958	160
2002-1307	58	2002-1874	108	2002-2239/099-000	78	2002-2959	160
2002-1308	58	2002-1874/401-000	108	2002-2247	76	2002-2961	132

Item No.	Page	Item No.	Page	Item No.	Page	Item No.	Page
2002 Series		2003 Series		2004 Series		2006 Series	
2002-2963	132	2003-911/1000-923	234	2004-1291	46	2006-931/1099-542	135
2002-2971	160			2004-1292	46	2006-931/1099-836	135
2002-2972	160	2003-6640	232	2004-1293	46	2006-931/1099-859	135
2002-2974	160	2003-6641	230	2004-1294	46	2006-991	120
2002-2991	132	2003-6642	230			2006-992	120
2002-2992	132	2003-6643	232	2004-1301	62		
		2003-6644	230	2004-1302	62	2006-1201	64
2002-3201	88	2003-6645	230	2004-1303	62	2006-1202	64
2002-3203	88	2003-6646	230	2004-1304	62	2006-1204	64
2002-3204	88	2003-6649	230	2004-1305	62	2006-1207	64
2002-3207	88	2003-6650	230	2004-1306	62	2006-1208	64
2002-3208	88	2003-6651	230	2004-1307	62	2006-1291	48
2002-3209	88	2003-6660	232	2004-1311/1000-400	150	2006-1292	48
2002-3211/1000-410	166	2003-6661	232	2004-1311/1000-401	150	2006-1293	48
2002-3211/1000-411	166	2003-6662	232	2004-1391	46	2006-1294	48
2002-3211/1000-675	166	2003-6692	230	2004-1392	46		
2002-3211/1000-676	166	2003-6693	232	2004-1393	46	2006-1301	64
2002-3212/1000-673	166	2003-6694	232	2004-1394	46	2006-1302	64
2002-3212/1000-674	166					2006-1304	64
2002-3217	88	2003-7300	228	2004-1401	62	2006-1305	64
2002-3218	89			2004-1402	62	2006-1307	64
2002-3221/1000-413	166	2003-7640	228	2004-1403	62	2006-1391	48
2002-3221/1000-434	166	2003-7641	228	2004-1404	62	2006-1392	48
2002-3227	88	2003-7642	228	2004-1405	62	2006-1393	48
2002-3228	89	2003-7645	228	2004-1406	62	2006-1394	48
2002-3231	88	2003-7646	228	2004-1407	62		
2002-3233	88	2003-7649	228	2004-1408	62	2006-1601	117
2002-3234	88	2003-7650	228	2004-1411/1000-400	150	2006-1604	117
2002-3237	88	2003-7651	228	2004-1411/1000-401	150	2006-1611	120
2002-3238	88	2003-7659	228	2004-1491	46	2006-1611/1000-541	120
2002-3239	88	2003-7692	228	2004-1492	46	2006-1611/1000-542	120
2002-3247	88			2004-1493	46	2006-1611/1000-836	120
2002-3248	89	2004 Series		2004-1494	46	2006-1611/1000-867	120
2002-3257	88	2004-115	29			2006-1621	120
2002-3258	89	2004-171	29	2005 Series		2006-1621/1000-541	120
2002-3291	89	2004-172	29	2005-7300	236	2006-1621/1000-542	120
2002-3292	89					2006-1621/1000-836	120
		2004-402	29	2005-7641	236	2006-1621/1000-859	120
2002-4101	90	2004-403	29	2005-7642	236	2006-1631	120
2002-4111	90	2004-404	29	2005-7645	236	2006-1631/099-000	121
2002-4127	90	2004-405	29	2005-7646	236	2006-1631/1000-541	120
2002-4131	90	2004-405/011-000	177	2005-7649	236	2006-1631/1000-542	120
2002-4141	90	2004-406	29	2005-7692	236	2006-1631/1000-836	120
2002-4157	90	2004-406/020-000	177			2006-1631/1000-859	120
2002-4191	90	2004-407	29	2006 Series		2006-1631/1000-867	120
2002-4192	90	2004-408	29	2006-115	30	2006-1631/1099-541	121
		2004-409	29	2006-191	181	2006-1631/1099-542	121
2002-6301	60	2004-410	29			2006-1631/1099-836	121
2002-6302	60	2004-433	29	2006-401	180	2006-1631/1099-859	121
2002-6303	60	2004-434	29	2006-401/000-050	180	2006-1631/1099-867	121
2002-6304	60	2004-435	29	2006-402	30	2006-1661	116
2002-6305	60	2004-436	29	2006-403	30	2006-1664	116
2002-6306	60	2004-437	29	2006-404	30	2006-1671	116
2002-6307	60	2004-438	29	2006-405	30	2006-1671/1000-848	116
2002-6308	60	2004-439	29	2006-405/011-000	177	2006-1671/1000-849	116
2002-6391	44	2004-440	29	2006-433	30	2006-1671/1000-850	116
2002-6392	44			2006-434	30	2006-1671/1000-851	116
		2004-511	170	2006-435	30	2006-1674	116
2002-6401	61	2004-541	170	2006-451	180	2006-1681	119
2002-6402	61	2004-549	170	2006-499	40	2006-1681/1000-413	118
2002-6403	61	2004-552	170			2006-1681/1000-414	118
2002-6404	61	2004-553	170	2006-511	170	2006-1681/1000-429	118
2002-6405	61	2004-554	170	2006-549	170	2006-1681/1000-434	118
2002-6406	61	2004-555	170			2006-1681/1000-435	118
2002-6407	61			2006-911	134	2006-1681/1000-449	118
		2004-911	132	2006-911/1000-541	134	2006-1691	116
2002-7111	238	2004-911/1000-541	132	2006-911/1000-542	134	2006-1692	116
2002-7114	238	2004-911/1000-542	132	2006-911/1000-836	134	2006-1695	134
2002-7192	238	2004-911/1000-836	132	2006-921	134	2006-1696	134
		2004-911/1000-867	132	2006-921/1000-541	134		
2002-7211	238			2006-921/1000-542	134	2006-7111	238
2002-7214	238	2004-1201	62	2006-921/1000-836	134	2006-7114	238
2002-7292	238	2004-1202	62	2006-921/1000-859	134	2006-7192	238
		2004-1203	62	2006-931	134		
2003 Series		2004-1204	62	2006-931/099-000	134	2006-7300	238
2003-499	230	2004-1205	62	2006-931/1000-541	134		
		2004-1206	62	2006-931/1000-836	134	2006-8401	122
2003-500	230	2004-1207	62	2006-931/1000-859	134		
		2004-1211/1000-400	150	2006-931/1000-867	134	2006-8601	122
2003-911	234	2004-1211/1000-401	150	2006-931/1099-541	135	2006-8604	122
						2006-8661	122

Item Number Index

Item No.	Page	Item No.	Page	Item No.	Page	Item No.	Page
2006 Series		2010 Series		2020 Series		2020 Series	
2006-8664	122	2010-1208	65	2020-103/000-039	195	2020-113/125-000	198
2006-8671	122	2010-1291	49	2020-103/122-000	198	2020-113/135-000	198
2006-8674	122	2010-1292	49	2020-103/132-000	198	2020-113/145-000	198
2006-8691	122			2020-103/142-000	198	2020-114	190
2006-8692	122	2010-1301	65	2020-104	190	2020-114/000-036	194
		2010-1301/000-053	65	2020-104/000-036	194	2020-114/000-037	194
		2010-1302	65	2020-104/000-037	194	2020-114/000-038	194
		2010-1304	65	2020-104/000-038	194	2020-114/000-039	195
2007 Series		2010-1305	65	2020-104/000-039	195	2020-114/125-000	198
2007-8442	128	2010-1307	65	2020-104/124-000	198	2020-114/135-000	198
2007-8443	128	2010-1391	49	2020-104/133-000	198	2020-114/145-000	198
2007-8444	128	2010-1392	49	2020-104/143-000	198	2020-115	190
2007-8445	128			2020-105	190	2020-115/000-036	194
2007-8446	128	2010-7111	238	2020-105/000-036	194	2020-115/000-037	194
2007-8447	128	2010-7114	238	2020-105/000-037	194	2020-115/000-038	194
2007-8448	128	2010-7192	238	2020-105/000-038	194	2020-115/000-039	194
				2020-105/000-039	195	2020-115/125-000	198
2007-8801	128	2016 Series		2020-105/124-000	198	2020-115/135-000	198
2007-8804	128	2016-100	32	2020-105/133-000	198	2020-115/145-000	198
2007-8807	129	2016-115	32	2020-105/143-000	198	2020-161	192
2007-8811	128			2020-106	190	2020-164	192
2007-8821	128	2016-402	32	2020-106/000-036	194	2020-167	192
2007-8873	130	2016-403	32	2020-106/000-037	194	2020-181	192
2007-8876	131	2016-404	32	2020-106/000-038	194	2020-184	192
2007-8891	128	2016-405	32	2020-106/000-039	195	2020-187	192
2007-8892	128	2016-405/011-000	177	2020-106/124-000	198		
2007-8893	128	2016-433	32	2020-106/133-000	198	2020-202	190
2007-8894	128	2016-434	32	2020-106/143-000	198	2020-202/122-000	200
2007-8899	128	2016-435	32	2020-107	190	2020-202/132-000	200
		2016-499	49	2020-107/000-036	194	2020-202/142-000	200
				2020-107/000-037	194	2020-203	190
2009 Series		2016-511	171	2020-107/000-038	194	2020-203/000-036	196
2009-110	640	2016-549	171	2020-107/000-039	195	2020-203/000-037	196
2009-113	640			2020-107/124-000	198	2020-203/000-038	196
2009-114	640	2016-1201	66	2020-107/134-000	198	2020-203/000-039	197
2009-115	640	2016-1202	66	2020-107/144-000	198	2020-203/122-000	200
2009-145	641	2016-1203	66	2020-108	190	2020-203/132-000	200
2009-163	649	2016-1204	66	2020-108/000-036	194	2020-203/142-000	200
2009-174	173	2016-1207	66	2020-108/000-037	194	2020-204	190
2009-180	177	2016-1208	66	2020-108/000-038	194	2020-204/000-036	196
2009-182	173	2016-1291	50	2020-108/000-039	195	2020-204/000-037	196
2009-191	646	2016-1292	50	2020-108/124-000	198	2020-204/000-038	196
2009-192	646			2020-108/134-000	198	2020-204/000-039	197
2009-193	646	2016-1301	66	2020-108/144-000	198	2020-204/124-000	200
2009-196	646	2016-1302	66	2020-109	190	2020-204/133-000	200
2009-198	646	2016-1303	66	2020-109/000-036	194	2020-204/143-000	200
		2016-1304	66	2020-109/000-037	194	2020-205	190
2009-304	228	2016-1305	66	2020-109/000-038	194	2020-205/000-036	196
2009-305	228	2016-1306	66	2020-109/000-039	195	2020-205/000-037	196
2009-309	664	2016-1307	66	2020-109/124-000	198	2020-205/000-038	196
2009-310	664	2016-1391	50	2020-109/134-000	198	2020-205/000-039	197
		2016-1392	50	2020-109/144-000	198	2020-205/124-000	200
2009-402	178			2020-110	190	2020-205/133-000	200
2009-404	178	2016-7111	239	2020-110/000-036	194	2020-205/143-000	200
2009-406	178	2016-7114	239	2020-110/000-037	194	2020-206	190
2009-412	178	2016-7192	239	2020-110/000-038	194	2020-206/000-036	196
2009-414	178			2020-110/000-039	195	2020-206/000-037	196
2009-414/000-005	178	2016-7601	240	2020-110/125-000	198	2020-206/000-038	196
2009-414/000-006	178	2016-7604	240	2020-110/135-000	198	2020-206/000-039	197
2009-416	178	2016-7607	240	2020-110/145-000	198	2020-206/124-000	200
		2016-7608	554	2020-111	190	2020-206/133-000	200
2010 Series		2016-7611	554	2020-111/000-036	194	2020-206/143-000	200
2010-100	31	2016-7614	555	2020-111/000-037	194	2020-207	190
2010-115	31	2016-7691	240	2020-111/000-038	194	2020-207/000-036	196
		2016-7692	240	2020-111/000-039	195	2020-207/000-037	196
2010-402	31			2020-111/125-000	198	2020-207/000-038	196
2010-403	31	2016-7711	240	2020-111/135-000	198	2020-207/000-039	197
2010-404	31	2016-7714	240	2020-111/145-000	198	2020-207/124-000	200
2010-405	31	2016-7792	240	2020-112	190	2020-207/134-000	200
2010-405/011-000	177			2020-112/000-036	194	2020-207/144-000	200
2010-433	31	2020 Series		2020-112/000-037	194	2020-208	190
2010-434	31	2020-100	143	2020-112/000-038	194	2020-208/000-036	196
2010-435	31	2020-102	190	2020-112/000-039	195	2020-208/000-037	196
		2020-102/122-000	198	2020-112/125-000	198	2020-208/000-038	196
2010-511	170	2020-102/132-000	198	2020-112/135-000	198	2020-208/000-039	197
2010-549	170	2020-102/142-000	198	2020-112/145-000	198	2020-208/124-000	200
		2020-103	190	2020-113	190	2020-208/134-000	200
2010-1201	65	2020-103/000-036	194	2020-113/000-036	194	2020-208/144-000	200
2010-1201/000-053	65	2020-103/000-037	194	2020-113/000-037	194	2020-209	190
2010-1202	65	2020-103/000-038	194	2020-113/000-038	194	2020-209/000-036	196
2010-1204	65	2020-103/000-039	194	2020-113/000-039	195	2020-209/000-037	196
2010-1205	65						
2010-1207	65						

Item No.	Page	Item No.	Page	Item No.	Page	Item No.	Page
2020 Series		2020 Series		2022 Series		2022 Series	
2020-209/000-038	196	2020-2204	188	2022-105/144-000	214	2022-115/000-037	212
2020-209/000-039	197	2020-2207	188	2022-105/999-953	222	2022-115/000-038	212
2020-209/124-000	200	2020-2208	188	2022-106	208	2022-115/000-039	213
2020-209/134-000	200	2020-2209	188	2022-106/000-036	212	2022-115/127-000	214
2020-209/144-000	200	2020-2217	188	2022-106/000-037	212	2022-115/137-000	214
2020-210	190	2020-2227	188	2022-106/000-038	212	2022-115/147-000	214
2020-210/000-036	196	2020-2231	188	2022-106/000-038/999-953	223	2022-141	190
2020-210/000-037	196	2020-2232	188	2022-106/000-039	213	2022-142	190
2020-210/000-038	196	2020-2233	188	2022-106/000-039/999-953	223	2022-151	190
2020-210/000-039	197	2020-2234	188	2022-106/123-000	214	2022-152	190
2020-210/125-000	200	2020-2237	188	2022-106/134-000	214	2022-161	210
2020-210/135-000	200	2020-2238	188	2022-106/144-000	214	2022-162	210
2020-210/145-000	200	2020-2239	188	2022-106/999-953	222	2022-164	210
2020-211	190	2020-2247	188	2022-107	208	2022-167	210
2020-211/000-036	196	2020-2257	188	2022-107/000-036	212	2022-171	210
2020-211/000-037	196	2020-2291	189	2022-107/000-037	212	2022-172	210
2020-211/000-038	196	2020-2292	189	2022-107/000-038	212	2022-174	210
2020-211/000-039	197			2022-107/000-039	213	2022-177	210
2020-211/125-000	200	2020-5311	143	2022-107/123-000	214	2022-181	210
2020-211/135-000	200	2020-5311/1102-950	143	2022-107/135-000	214	2022-182	210
2020-211/145-000	200	2020-5317/102-000	145	2022-107/145-000	214	2022-184	210
2020-212	190	2020-5317/1102-950	145	2022-107/999-953	222	2022-187	210
2020-212/000-036	196	2020-5372	143	2022-108	208		
2020-212/000-037	196	2020-5372/1102-953	143	2022-108/000-036	212	2022-1201	202
2020-212/000-038	196	2020-5377/102-000	145	2022-108/000-037	212	2022-1201/999-953	216
2020-212/000-039	197	2020-5391	143	2022-108/000-038	212	2022-1202	202
2020-212/125-000	200			2022-108/000-039	213	2022-1204	202
2020-212/135-000	200	2020-5417	144	2022-108/123-000	214	2022-1204/999-953	216
2020-212/145-000	200	2020-5417/1102-950	144	2022-108/135-000	214	2022-1207	202
2020-213	190	2020-5477	144	2022-108/145-000	214	2022-1207/999-953	216
2020-213/000-036	196	2020-5477/1102-953	144	2022-108/999-953	222	2022-1291	202
2020-213/000-037	196	2020-5491	144	2022-109	208	2022-1292	202
2020-213/000-038	196			2022-109/000-036	212		
2020-213/000-039	197	2022 Series		2022-109/000-037	212	2022-1301	202
2020-213/125-000	200	2022-100	202	2022-109/000-038	212	2022-1301/999-953	216
2020-213/135-000	200	2022-101	208	2022-109/000-039	213	2022-1302	202
2020-213/145-000	200	2022-101/122-000	214	2022-109/123-000	214	2022-1304	202
2020-214	190	2022-101/122-006	214	2022-109/135-000	214	2022-1304/999-953	216
2020-214/000-036	196	2022-101/122-016	214	2022-109/145-000	214	2022-1307	202
2020-214/000-037	196	2022-101/132-000	214	2022-110	208	2022-1307/999-953	216
2020-214/000-038	196	2022-101/132-006	214	2022-110/000-036	212	2022-1391	202
2020-214/000-039	197	2022-101/132-016	214	2022-110/000-037	212	2022-1392	202
2020-214/125-000	200	2022-101/142-000	214	2022-110/000-038	212		
2020-214/135-000	200	2022-101/142-006	214	2022-110/000-039	213	2022-1401	202
2020-214/145-000	200	2022-101/142-016	214	2022-110/123-000	214	2022-1401/999-953	216
2020-215	190	2022-102	208	2022-110/135-000	214	2022-1402	202
2020-215/000-036	196	2022-102/122-000	214	2022-110/145-000	214	2022-1404	202
2020-215/000-037	196	2022-102/132-000	214	2022-111	208	2022-1404/999-953	216
2020-215/000-038	196	2022-102/142-000	214	2022-111/000-036	212	2022-1407	202
2020-215/000-039	197	2022-102/999-953	222	2022-111/000-037	212	2022-1407/999-953	216
2020-215/125-000	200	2022-103	208	2022-111/000-038	212	2022-1491	202
2020-215/135-000	200	2022-103/000-036	212	2022-111/000-039	213	2022-1492	202
2020-215/145-000	200	2022-103/000-037	212	2022-111/126-000	214		
2020-261	192	2022-103/000-038	212	2022-111/136-000	214	2022-1601	204
2020-264	192	2022-103/000-038/999-953	223	2022-111/146-000	214	2022-1601/999-953	218
2020-267	192	2022-103/000-039	213	2022-112	208	2022-1604	204
2020-281	192	2022-103/000-039/999-953	223	2022-112/000-036	212	2022-1604/999-953	218
2020-284	192	2022-103/123-000	214	2022-112/000-037	212	2022-1607	204
2020-287	192	2022-103/133-000	214	2022-112/000-038	212	2022-1607/999-953	218
		2022-103/143-000	214	2022-112/000-039	213	2022-1691	204
2020-1201	186	2022-103/999-953	222	2022-112/126-000	214	2022-1692	204
2020-1204	186	2022-104	208	2022-112/136-000	214		
2020-1207	186	2022-104/000-036	212	2022-112/146-000	214	2022-1801	204
2020-1291	186	2022-104/000-037	212	2022-113	208	2022-1801/999-953	218
2020-1292	186	2022-104/000-038	212	2022-113/000-036	212	2022-1804	204
		2022-104/000-038/999-953	223	2022-113/000-037	212	2022-1804/999-953	218
2020-1301	186	2022-104/000-039	213	2022-113/000-038	212	2022-1807	204
2020-1304	186	2022-104/000-039/999-953	223	2022-113/000-039	213	2022-1807/999-953	218
2020-1307	186	2022-104/123-000	214	2022-113/126-000	214	2022-1891	204
2020-1391	186	2022-104/133-000	214	2022-113/136-000	214	2022-1892	204
2020-1392	186	2022-104/143-000	214	2022-113/146-000	214		
		2022-104/999-953	222	2022-114	208	2022-2201	206
2020-1401	186	2022-105	208	2022-114/000-036	212	2022-2201/999-953	220
2020-1404	186	2022-105/000-036	212	2022-114/000-037	212	2022-2202	206
2020-1407	186	2022-105/000-037	212	2022-114/000-038	212	2022-2202/999-953	220
2020-1491	186	2022-105/000-038	212	2022-114/000-039	213	2022-2203	206
2020-1492	186	2022-105/000-038/999-953	223	2022-114/126-000	214	2022-2203/999-953	220
		2022-105/000-039	213	2022-114/136-000	214	2022-2204	206
2020-2201	188	2022-105/000-039/999-953	223	2022-114/146-000	214	2022-2204/999-953	220
2020-2202	188	2022-105/123-000	214	2022-115	208	2022-2207	206
2020-2203	188	2022-105/134-000	214	2022-115/000-036	212	2022-2207/999-953	220

Item Number Index

Item No.	Page	Item No.	Page	Item No.	Page	Item No.	Page
2022 Series		2104 Series		2200 Series		2202 Series	
2022-2208	206	2104-1301	29	2200-1201	38	2202-1804	97
2022-2208/999-953	220	2104-1304	29	2200-1204	38	2202-1811	103
2022-2209	206	2104-1307	29	2200-1207	38	2202-1811/1000-541	103
2022-2209/999-953	220	2104-1391	29			2202-1811/1000-542	103
2022-2217	206	2104-1392	29	2200-1301	38	2202-1811/1000-836	103
2022-2217/999-953	220			2200-1304	38	2202-1811/1000-867	103
2022-2227	206	2104-5201	34	2200-1307	38	2202-1861	96
2022-2227/999-953	220	2104-5204	34			2202-1871	96
2022-2231	206	2104-5207	34	2200-1401	38	2202-1872	96
2022-2231/999-953	220			2200-1404	38	2202-1874	96
2022-2232	206	2104-5301	34	2200-1407	38	2202-1881	96
2022-2232/999-953	220	2104-5304	34				
2022-2233	206	2104-5307	34			2202-1901	99
2022-2233/999-953	220			2201 Series		2202-1902	99
2022-2234	206	2106 Series		2201-1201	40	2202-1904	99
2022-2234/999-953	220	2106-1201	30	2201-1204	40	2202-1907	99
2022-2237	206	2106-1204	30	2201-1207	40	2202-1911	102
2022-2237/999-953	220	2106-1207	30			2202-1911/1000-541	102
2022-2238	206	2106-1207	30	2201-1301	40	2202-1911/1000-542	102
2022-2238/999-953	220	2106-1291	30	2201-1302	40	2202-1911/1000-836	102
2022-2239	206	2106-1292	30	2201-1304	40	2202-1911/1000-867	102
2022-2239/999-953	220			2201-1307	40	2202-1961	98
2022-2247	206	2106-1301	30			2202-1971	98
2022-2247/999-953	220	2106-1304	30	2201-1401	40	2202-1972	98
2022-2257	206	2106-1307	30	2201-1404	40	2202-1974	98
2022-2257/999-953	220	2106-1391	30	2201-1407	40	2202-1981	98
2022-2291	207	2106-1392	30			2202-1981/1000-413	100
2022-2292	207			2202 Series		2202-1981/1000-414	100
		2106-5201	35	2202-1201	42	2202-1981/1000-429	100
2042 Series		2106-5204	35	2202-1203	42	2202-1981/1000-434	100
2042-321	158	2106-5207	35	2202-1204	42	2202-1981/1000-435	100
2042-331	158			2202-1205	42	2202-1981/1000-449	100
2042-341	158	2106-5301	35	2202-1207	42		
2042-351	158	2106-5304	35	2202-1209	42	2202-2701	70
		2106-5307	35			2202-2702	70
				2202-1301	42	2202-2703	70
2050 Series				2202-1302	42	2202-2704	70
2050-301	252	2110 Series		2202-1303	42	2202-2707	70
2050-304	252	2110-1201	31	2202-1304	42	2202-2708	70
2050-307	252	2110-1204	31	2202-1305	42	2202-2709	70
2050-311	253	2110-1207	31	2202-1307	42	2202-2717	70
2050-314	253	2110-1291	31	2202-1309	42	2202-2727	70
2050-317	253	2110-1292	31				
2050-321	252			2202-1401	42	2202-6301	44
2050-324	252	2110-1301	31	2202-1403	42	2202-6302	44
2050-327	252	2110-1304	31	2202-1404	42	2202-6303	44
2050-381	250	2110-1307	31	2202-1405	42	2202-6304	44
2050-391	251	2110-1391	31	2202-1407	42	2202-6305	44
		2110-1392	31	2202-1409	42	2202-6306	44
2050-1201	249					2202-6307	44
2050-1204	249	2110-5201	36	2202-1601	93		
2050-1207	249	2110-5204	36	2202-1602	93	2202-6401	45
2050-1291	248	2110-5207	36	2202-1604	93	2202-6402	45
				2202-1611	102	2202-6403	45
2102 Series		2110-5301	36	2202-1611/1000-541	102	2202-6404	45
2102-1201	28	2110-5304	36	2202-1611/1000-542	102	2202-6405	45
2102-1204	28	2110-5307	36	2202-1611/1000-836	102	2202-6406	45
2102-1207	28			2202-1611/1000-867	102	2202-6407	45
2102-1291	28	2116 Series		2202-1661	92		
2102-1292	28	2116-1201	32	2202-1671	92	2204 Series	
		2116-1201/605-038	32	2202-1672	92	2204-1201	46
2102-1301	28	2116-1204	32	2202-1674	92	2204-1204	46
2102-1304	28	2116-1207	32	2202-1681	92	2204-1207	46
2102-1307	28	2116-1291	32				
2102-1391	28	2116-1292	32	2202-1701	95	2204-1301	46
2102-1392	28			2202-1702	95	2204-1304	46
		2116-1301	32	2202-1704	95	2204-1307	46
2102-5201	33	2116-1304	32	2202-1707	95		
2102-5204	33	2116-1307	32	2202-1711	102	2204-1401	46
2102-5207	33	2116-1391	32	2202-1711/1000-541	102	2204-1404	46
		2116-1392	32	2202-1711/1000-542	102	2204-1407	46
2102-5301	33			2202-1711/1000-836	102		
2102-5304	33	2116-5201	37	2202-1711/1000-867	102		
2102-5307	33	2116-5204	37	2202-1761	94	2206 Series	
		2116-5207	37	2202-1771	94	2206-1201	48
2104 Series				2202-1772	94	2206-1204	48
2104-1201	29	2116-5301	37	2202-1774	94	2206-1207	48
2104-1204	29	2116-5304	37	2202-1781	94		
2104-1207	29	2116-5307	37			2206-1301	48
2104-1291	29			2202-1801	97	2206-1304	48
2104-1292	29			2202-1802	97	2206-1307	48

Item No.	Page	Item No.	Page	Item No.	Page	Item No.	Page
2210 Series							
2210-1201	49						
2210-1204	49						
2210-1207	49						
2210-1301	49						
2210-1304	49						
2210-1307	49						
2216 Series							
2216-1201	50						
2216-1204	50						
2216-1207	50						
2216-1301	50						
2216-1304	50						
2216-1307	50						
2250 Series							
2250-301	250						
2250-304	250						
2250-307	250						
2250-311	251						
2250-314	251						
2250-317	251						
2250-321	250						
2250-324	250						
2250-327	250						
2250-1201	248						
2250-1204	248						
2250-1207	248						
2273 Series							
2273-202	573						
2273-203	573						
2273-204	573						
2273-205	573						
2273-208	573						
2273-500	573						

Success for generations: environmental protection at WAGO



At WAGO, we see environmental protection not only as compliance with environmental protection requirements.

As a growing company, our commitment to the environment drives our efforts to deliver new ideas, new concepts and new technologies along the product lifecycle. Here our employees and business partners support us.

Corporate environmental protection

Business growth also leads to higher consumption of resources. We have realized that the economic success of a company also depends on the achievement of environmental goals.

As a manufacturing company, we therefore support developments that make a contribution to environmental protection. In doing so, we always pursue individual material flows along the value chain, because we see resources, product design, production and consumption as a whole.

With our environmental management system certified in accordance with DIN EN ISO 14001, we ensure that the required national and international requirements are complied with in all areas of the company and that the concept of environmental protection is practiced in all corporate processes. In addition, WAGO is pursuing further efforts in the field of environmental protection that go far beyond the requirements of ISO

Some examples include the recycling of plastics, resource savings on product and packaging materials, the use of recycled paper throughout the company, the introduction of e-filling stations and the use of waste heat from production processes.

Product-related environmental protection

Product-related environmental protection is an important part of sustainable environmental management at WAGO. Ensuring compliance with substance bans / restrictions worldwide, such as: As REACH, RoHS has a high priority.

Success for generations: environmental protection at WAGO

RoHS – Restriction of the use of certain Hazardous Substances

It is an EC directive that regulates the use of certain hazardous substances in electrical and electronic equipment. In addition to reducing the harmful effects on humans and the environment, legislation aims to improve recycling possibilities. WAGO closely monitors the development regarding RoHS and reacts promptly to specifications accordingly. For more information about RoHS please contact us via ehs-product-compliance@wago.com.

RoHS 
Compliant

REACH – Registration, Evaluation and Authorisation of Chemicals

On 01.06.2007 the regulation (EC) no. 1907/2006 (REACH regulation) came into force and since then forms a valid legal basis for all EU member states. To protect human health and the environment, this EU Chemicals Regulation aims to classify and identify all chemicals, including their effects.

The REACH Regulation creates specific obligations for each actor in the supply chain. The products manufactured by WAGO are to be designated as products in the sense of the regulation. Since products are not subject to registration, WAGO usually assumes the role of the downstream user in the supply chain. WAGO therefore has an obligation to provide information along the supply chain in accordance with REACH Article 33. WAGO is naturally aware of this obligation.

For more information about our reporting requirements according to REACH Article 33 please visit our website "REACH SVHC Declaration" via www.wago.com/svhc

BOMcheck

European legislation such as REACH or RoHS requires the provision of information on restricted ingredients in products. This information must be shared by manufacturers and suppliers in the supply chain. WAGO meets this challenge in product-related environmental protection successfully and efficiently with BOMcheck.

BOMcheck .net

BOMcheck is a centralized database for the declaration of ingredients. It is a compliance tool specifically designed to enable manufacturers and suppliers to produce their substance declarations under REACH, RoHS, and other restrictions on ingredients in an efficient and structured manner. This Internet database system increases data quality in the area of product-related environmental protection.

Further information on BOMcheck can be found at the following link: <http://www.bomcheck.net>

Less is more: our packaging

Recycling is the basis for choosing our packaging materials. All packaging used by WAGO can be recycled in the economic cycle without further pretreatment. In addition to the aspect of recycling, emphasis is placed on resource conservation. For this reason, our cardboard boxes consist of 80% recycled paper and are marked with the Resy symbol. The Resy symbol guarantees compliance with the Packaging Ordinance for transport packaging. The labeling is partly done by perforation. This process enables the colorless printing of WAGO cardboard boxes. This avoids unnecessary environmental pollution.

WAGO Worldwide Companies and Representatives

- Algeria**
Please contact WAGO France
- Argentina**
Bruno Schillig S.A.
Arenales 4030, B1604CFD
Florida, PBA
Phone +54 11 4730 1100
Fax +54 11 4761 7244
wago@schillig.com.ar
- Armenia**
ROOT ITSP LLC
33 Halabyan str.
0038, Yerevan
info@root.am
- Australia**
WAGO Pty. Ltd.
2-4 Overseas Drive
Noble Park Victoria 3174
Phone +61 03 8791 6300
Fax +61 03 9701 0177
sales.anz@wago.com
- Austria**
WAGO Kontakttechnik Ges.m.b.H.
Europaring F15 602
Campus 21
2345 Brunn am Gebirge
Phone +43 1 6150780
Fax +43 1 6150775
wago-at@wago.com
- Azerbaijan**
AZ Technics LTD
Zulfi V. Alizade
Y.Safarov str.33, AZ1025,
Baku
Phone +994 50 210 24 49
Fax +994 12 496 83 34
info@AZtechnics.az
- Bangladesh**
Please contact WAGO India
- Belarus**
DemsEnergo LLC
Vostochnaya Str. 39, Office 1N.
220040 Minsk
Phone +375 17 2102189
Fax +375 17 2102189
dems@dems.by
- ATAVA Techno Ltd.
Ul. Denisovskaya 47, office 1
220006 Minsk
Phone +375173881018
atava@atava.by
- Belgium**
WAGO BeLux nv
Excelsiorlaan 11
1930 Zaventem
Phone +32 2 717 9090
Fax +32 2 717 9099
info-be@wago.com
- Bolivia**
ISOTEK S.R.L.
Zona Casco Viejo
Calle Isso #578, B/San Roque
Santa Cruz
Phone +591 721 000 27
info@isotek.bo
- Bosnia & Herzegovina**
Please contact WAGO Bulgaria
- Brazil**
WAGO Eletroeletrônicos Ltda
Rua Tripoli, 640, Loteamento Multivias II
Jardim Ermida I
Jundiaí - SP
CEP 13212-217
Phone +55 (11) 2923 7200
info.br@wago.com
- Bulgaria**
WAGO Kontakttechnik GmbH & Co. KG
Representative Office Sofia
Business Center Serdiika
2E Akad. Ivan Geshov Blvd.
Building 1, Floor 4, Office 417
1330 Sofia
Phone +359 2 489 46 09/10
Fax +359 2 928 28 50
info-BG@wago.com
- Canada**
WAGO Canada, Inc.
1550 Yorkton Court - Unit 1
Burlington, ON L7P 5B7
Phone +1-888-9246-221
info.ca@wago.com
- Chile**
Desimat Chile
Av Puerto Vespuccio 9670
Pudahuel Santiago
Phone +56 2 747 0152
Fax +56 2 747 0153
ventaschile@desimat.cl
- China**
WAGO Electronic (Tianjin) Co., Ltd.
No.5, Quan Hui Road
Wuqing Development Area
Tianjin 301700
Phone +86 22 5967 7688
Fax +86 22 5961 7668
info-cn@wago.com
- Colombia**
T.H.L. Ltda.
Cra. 49 B #91-33
Bogotá
Phone +57 1 621 85 50
Fax +57 1 621 60 28
ventas-thl2@thl.com.co
- Croatia**
M.B.A. d.o.o.
Frana Supila 5
51211 Matulji
Phone +385 51 275-736
Fax +385 51 275-066
mba@ri.htnet.hr
- MICROSTAR d.o.o.
Siget 18 b
10020 Zagreb
Phone +385 1 3647 849
Fax +385 1 3636 662
wago@microstar.hr
- Czech Republic**
WAGO Elektro spol. sr. o.
Rozvodova 1116/36
143 00 Praha 12 - Modřany
Phone +420 261 090 143
info.cz@wago.com
wago-cz@wago.com
- Denmark**
WAGO Denmark A/S
Lejrvej 17
3500 Værløse
Phone +45 44 357 777
info.dk@wago.com
- Ecuador**
ECUAINSETEC CIA LTDA
Yugoslavia N34-110 y Azuay
Quito
Phone +593 2 24 50 475
Fax +593 2 22 51 242
g.castro@ecuainsetec.com.ec
- Egypt**
IBN Engineering / Distributor (Automation
Products)
Phone +2 02 3 721 43 50
Fax +2 02 3 722 17 09
nasrelwy@ibnengineering.com
- Estonia**
Eltarko OÜ
Treiali tee 2 door 6
Peetri küla
Rae vald
75312 Harjumaa
Phone +372 651 7731/32
Fax +372 651 7786
andres@eltarko.ee
- Finland**
WAGO Finland Oy
Äyritie 12 B
01510 Vantaa
Phone +358 9 7744 060
Fax +358 9 7744 0660
info.fi@wago.com
- France**
WAGO Contact SAS
Paris Nord 2
83 Rue des Chardonnerets
93290 - Tremblay en France
B.P. 95947 - ROISSY CDG CEDEX
Phone +33 1 4817 2590
Fax +33 1 4863 2520
info-fr@wago.com
- Germany**
WAGO Kontakttechnik GmbH & Co. KG
Hansastraße 27
32423 Minden
Phone +49 571 887-0
Fax +49 571 887-169
info@wago.com
- WAGO Kontakttechnik GmbH & Co. KG
Waldstraße 1
99706 Sondershausen
Phone +49 3632 659-0
Fax +49 3632 659-100
info@wago.com
- Great Britain**
WAGO Limited
Triton Park, Swift Valley Industrial Estate
RUGBY
Warwickshire, CV21 1SG
Phone +44 1788 568 008
Fax +44 1788 568 050
uksales@wago.com
- Greece**
PANAGIOTIS SP. DIMOULAS
DIMOULAS AUTOMATIONS
Kritis Str. 26
10439 Athens
Phone +30 210 883 3337
Fax +30 210 883 4436
wago.info@dimoulas.com.gr
- Honduras**
CILASAS S.A. de C.V.
Barrio Los Andes
7 Calle entre 14 y 15 Ave. N.O.
P.O. Box. 1061
San Pedro Sula
Phone +504 2557 1146/7
Fax +504 2557 1149
ventas@iecilasa.com
- Hong Kong**
National Concord Eng., Ltd.
Unit A-B, 5/F.
Southeast Industrial Building
611-619 Castle Peak Road
Tsuen Wan, N.T.
Phone +852 2429 2611
Fax +852 2429 2164
sales@nce.com.hk
- Hungary**
WAGO Hungária KFT
Ipari Park, Gyár u. 2
2040 Budapest
Phone +36 23 502-170
Fax +36 23 502-1
info.hu@wago.com
- Iceland**
Johan Rönning ehf / S.Gudjonsson
Smidjuvegur 3
200 Kopavogur
Phone +354 520-4500
Fax +354 520-4501
export@wago.com
- India**
WAGO Private Limited
C-27, Sector-58, Phase-III
Noida-201 301
Uttar Pradesh-201301
Phone +91 120 438 8700
Fax +91 120 438 8799
info.india@wago.com
- Indonesia**
Please contact WAGO Singapore
- Iraq**
Please contact WAGO Middle East
- Ireland**
Drives & Controls
Unit F4, Riverview Business Park
Nangor Road
Dublin 12
Phone +353 1 4604474
Fax +353 1 4604507
info@drivesandcontrols.ie
- Israel**
Comtel Israel Electronic Solutions Ltd.
Bet Hapaamon
20 Hataas Street
P.O. Box 66
44425 Kefar-Saba
Phone +972 9 76 77 240
Fax +972 9 76 77 243
sales@comtel.co.il
- Italy**
WAGO Elettronica SRL a Socio Unico
Via Parini 1
40033 Casalecchio di Reno (BO)
Phone +39 051 6132112
Fax +39 051 6132888
info-ita@wago.com
- Japan**
WAGO Co. of JAPAN Ltd.
Kinshicho Prime Tower
1-5-7, Kameido, Koto-ku
Tokyo 136-0071
Phone +81 3 5627 2050
Fax +81 3 5627 2055
info-jp@wago.com
- Jordan**
Oxgen for Engineering Systems Co. L.L.C
PO Box: 2154 Amman
11953 Jordan
Phone +962 79 9 860 869
Fax. +962 655 211 89
info@oxgn-grp.com
- Kazakhstan**
Axima LLP
232/2, Ryskulov avenue
050061 Almaty
Phone +7 727 356 52 91/92/93
Fax +7 727 327 14 92/93
trade1@axima.kz
or@axima.kz
- Technik-Tade LLC
Kabanbay Batyra Str. 11
office 305
070004 Ust-Kamenogorsk
Phone +7 7232 254064
Fax +7 7232 253251
info@technik.kz
- Korea**
WAGO Korea Co., Ltd.
Room A413~A416, A dong,
Indukwon IT Valley Building, Imiro 40,
Poil-dong,Uiwang-Si, Gyeonggi-do,
16006, South Korea
Phone +82 31 421 9500
Fax +82 31 360 2476
info.korea@wago.com
- Kosovo**
Please contact WAGO Bulgaria
- Latvia**
INSTABALT LATVIA SIA
Vestienas iela 6
Riga, LV-1035
Phone +371 6790 1188
Fax +371 6790 1180
info@instabalt.lv
- Lebanon**
Gemayel Trading & Contracting
Rue 55, Antonins Project-Bloc L
P.O. BOX 70-1096
Antelias, Lebanon
Phone +961 3 22 30 29
Fax +961 4 52 10 29
info@gtclb.com
- Lithuania**
INSTABALT LIT UAB
Savanorių 187
Vilnius, 2053
Phone +370 52 322 295
Fax +370 52 322 247
info@instabalt.lt
- Luxembourg**
Please contact WAGO Belgium
- Malaysia**
WAGO Automation Sdn. Bhd.
No 806, Block A4, Leisure Commerce
Square,
No 9, Jalan PJS 8/9, 46150 Petaling Jaya,
Selangor Darul Ehsan, Malaysia
Phone +60 3 7877 1776
Fax +60 3 7877 2776
info-my@wago.com

Maledivea

Please contact WAGO India

Mexico

WAGO S.A. de C.V.
Carretera estatal 431 Km. 2+200
Lote 99 Módulo 6
Parque Industrial Tecnológico Innovación Querétaro
El Marqués, Qro. 76246
Phone +52 442 221 5946
Fax +52 442 221 5063
info.mx@wago.com

Morocco

Automatisme & Connection Maroc
23, Rue Boured
2ème étage, appt4
Roche Noire
20300 Casablanca
Phone +212 522 24 21 72/73
Fax +212 522 24 21 75
info-fr@wago.com

Nepal

Please contact WAGO India

Netherlands

WAGO Nederland B.V.
Laan van de Ram 19
7234 BW APELDOORN
Phone +31 55 36 83 500
Fax +31 55 36 83 599
info-nl@wago.com

New Zealand

Please contact WAGO Australia

Engineering Computer Services Ltd
7-19 Ruffell Rd
Hamilton, 3200
New Zealand
Phone +64 (0) 7 849 2211
Fax +64 (0) 7 849 2220
sales@ecsnz.com

Nigeria

GIL Automations Ltd.
Daily Times Complex
2 Lateef Jakande Rd., Agidingbi
100271 Ikeja, Lagos State
Phone +234 17132672335
sales@gilautomation.com

Norway

WAGO Norge AS
Jerikoveien 20
1067 Oslo
Phone +47 22 30 94 50
Fax +47 22 30 94 51
info.no@wago.com

Oman

Please contact WAGO Middle East

Pakistan

FuziLogix Automation & Control
Suit No. 14, 5th Floor, Shan Arcade
New Garden Town, Lahore
Phone +92 42 594 1503 - 4
Fax +92 42 585 1431
info@fuzilogix.com

S.A. Hamid & Co.

7 Brandreth Road
Lahore, 54000
Phone +92 42 376 500 99
Fax +92 42 376 513 91
sales@sahamid.com

Paraguay

AESA
Av. Madame Lynch
c/Antolin Irala
2309 Asunción
Phone +59 521674524
info@aesa.com.py

Philippines

Please contact WAGO Singapore

Poland

WAGO ELWAG sp. z o. o.
ul. Piękna 58 a
50-506 Wrocław
Phone +48 71 3602970
Fax +48 71 3602999
wago.elwag@wago.com

Portugal

MORGADO & CA. LDA - SEDE
Estrada Exterior da
Circunvalação 3558/3560
Apartado 1057
4435 Rio Tinto
Phone +351 22 9770600
Fax +351 22 9770699
geral@morgadocl.pt

Quatar

GEBD - Gulf European Business
Development - Company W.L.L.)
PO Box: 20 000
Doha, Quatar
Phone +974 5591 5682
info@gebdc.com

Republic of Moldova

Smart Delight SRL
Bulgara Str. 9/6
2001 Chisinau
Phone +373 (373) 69 10 22 01
alexandres@starnet.md

Republic of North Macedonia

Please contact WAGO Bulgaria

Kompjunet Inzenering
Vladimir Komarov 1A-3/9
1000 Skopje
Phone +389 2 521 12 00

Romania

WAGO Kontakttechnik GmbH & Co. KG
Representative Office Romania
Sos. Pipera-Tunari nr. 1/1
building 1, 2nd floor
077190 Voluntari, Ilfov
Phone +40-(0)31 421 85 68
info-RO@wago.com

Russia

OOO WAGO Contact Rus
Ilinskaya strret 5, bldg. 2
127576 Moscow
Phone +7 495 223-4747
info.ru@wago.com
www.wago.ru

Saudi Arabia

Saudi Electronic Trading
P.O. Box 60712
Riyadh 11555
Phone +966 11 2063 377
Fax +966 11 4633 297
info@setra.com.sa

Serbia

Please contact WAGO Bulgaria

Mehatronik Sistem d.o.o.
Bul. Oslobodjenja 30
32000 Cacak
Phone +381 (0)32 310 088
Fax. +381 (0)32 371 571
Mobil +381 (0)64 877 22 02
office@mehatronik.com

Sigma Controls Engineering d.o.o.

Jovana Skerlica 22
18000 Nis
Mobil +381 (0)63 403 104
zeljko.savic@sce.rs

Singapore

WAGO Electronic Pte Ltd
138 Joo Seng Road #06-01
Singapore 368361
Phone +65 62866776
Fax +65 62842425
info-sing@wago.com

Slovakia

Proelektro spol. s r.o.
Na barine 22
841 03 Bratislava - Lamač
Phone +421 2 4569 2503
info@wago.sk

Slovenia

IC elektronika d.o.o.
Vodovodna cesta 100
1000 Ljubljana
Phone +386 1568 01 26
Fax +386 1568 91 07
info@ic-elect.si

Slovenia

Elektronabava d.o.o.
Cesta 24 junija 3
1231 Ljubljana
Phone +386 1 58 99 300
Fax +386 1 58 99 409
info@elektronabava.si

South Africa

Shorrock Automation CC
Nelmapius drive
5 Regency Drive, Route 21 Corp. Park
0051 Centurion
Phone +27 12 4500300
Fax +27 12 4500322
sales@shorrock.co.za

Spain

DICOMAT S.L.
Avda. de la Industria, 36
Apartado Correos, 1.178
28108-Alcobendas (Madrid)
Phone +34 91 662 1362
Fax +34 91 661 0089
info@dicomat-asetyc.com

Sri Lanka

Please contact WAGO India

Sweden

WAGO Sverige AB
Box 11127, 161 11 BROMMA
Besöksadress: Adolfsbergsv. 31
Phone +46 858410680
info.se@wago.com

Switzerland

WAGO CONTACT SA
Rte. de l'Industrie 19
Case Postale 168
1564 Domdidier
Phone +41/26 676 75 00
Fax +41/26 676 75 01
info.switzerland@wago.com

Syria

Please contact WAGO Middle East

Taiwan R.O.C.

WAGO Contact, Ltd.
5F, No.168, Jiankang Rd
Zhonghe City
Taipei County 23585, Taiwan
Phone +886 2 2225 0123
Fax +886 2 2225 1511
info.taiwan@wago.com

Thailand

WAGO Contact Ltd.
4th Floor, KS Building
213/6-8 Rachada-Phisek Road
Dingdaeng Bangkok 10400
Phone +66 2 6935611
Fax +66 2 6935612
info-th@wago.com

Tunisia

Please contact WAGO France

Turkey

WAGO Elektronik Sanayi ve Ticaret Ltd. Şti.
Yukarı Dudullu Mahallesi Bayraktar Bulvarı
Cad. Hattat Sok. No. 10
34775 Ümraniye - İstanbul
Phone +90 216 472 1133
Fax +90 216 472 9910
info.tr@wago.com

Ukraine

LLC RPE „Logicon“
Predslavinskaya street, 37, office 303
03150 Kiev
Phone +380 44 5228019
Fax +380 44 2611803
info@logicon.ua

Micropribor Ltd.

4, Krzhizhanovsky Str.
03142 Kiev
Phone +380 44 392 93 86
Fax +380 44 392 93 87
sales@micropribor.kiev.ua

United Arab Emirates (UAE)

WAGO Middle East (FZC)
SAIF Zone, Q4-282
P.O. Box 120665
Sharjah, UAE
Phone +971 6 5579920
Fax +971 6 5579921
info.uae@wago.com

Uruguay

Fivisa Electricidad
Avda. Uruguay 1274
11100 Montevideo
Phone +59 829 020 808
Fax +59 829 021 230
info@fivisa.com.uy

USA

WAGO CORPORATION
N120 W19129 Freistadt Road
Germantown, WI 53022
Phone +1 262 255 6222
Fax +1 262 255 3232
Toll-Free: 1-800 DIN Rail (346-7245)
info.us@wago.com

Venezuela

PETROBORNAS, C.A.
C.C. PLAZA AEROPUERTO - PISO 1 - LO-
CAL P1-B-03
(8015) UNARE - PUERTO ORDAZ -
ESTADO BOLÍVAR
REPÚBLICA BOLIVARIANA DE
VENEZUELA
Phone +58 286 951 3382
Fax +58 286 951 3382
info@petrobornas.com

Vietnam

Please contact WAGO Germany (Minden)

Version: 10/2020

Current addresses at www.wago.com

WAGO Kontakttechnik GmbH & Co. KG
Postfach 2880 · D · 32385 Minden
Hansastraße 27 · D · 32423 Minden
info@wago.com
www.wago.com

Headquarters	+49 571 887 - 0
Sales	+49 571 887 - 44222
Order Service	+49 571 887 - 44333
Fax	+49 571 887 - 844169

WAGO is a registered trademark of WAGO Verwaltungsgesellschaft mbH.

"Copyright – WAGO Kontakttechnik GmbH & Co. KG – All rights reserved. The content and structure of the WAGO websites, catalogs, videos and other WAGO media are subject to copyright. Distribution or modification to the contents of these pages and videos is prohibited. Furthermore, the content may neither be copied nor made available to third parties for commercial purposes. Also subject to copyright are the images and videos that were made available to WAGO Kontakttechnik GmbH & Co. KG by third parties."